



Analog Front End Converter for Set-Top Box, Cable Modem

AD9873

FEATURES

Low-Cost 3.3 V CMOS Analog Front End Converter for MCNS-DOCSIS, DVB, DAVIC-Compliant Set-Top Box, Cable Modem Applications
232 MHz Quadrature Digital Upconverter
DC to 65 MHz Output Bandwidth
12-Bit Direct IF D/A Converter (TxDAC+®)
Programmable Reference Clock Multiplier (PLL)
Direct Digital Synthesis
Interpolator
SIN(x)/x Compensation Filter
Four Programmable, Pin-Selectable Modulator Profiles
Single-Tone Mode for Frequency Synthesis Applications
12-Bit, 33 MSPS Sampling Direct IF A/D Converter with Auxiliary Automatic Clamp Video Input Multiplexer
10-Bit, 33 MSPS Sampling Direct IF A/D Converter
Dual 8-Bit, 16.5 MSPS Sampling IQ A/D Converter
Two Independently Programmable Sigma-Delta Converters
Direct Interface to AD8321/AD8323 PGA Cable Driver
Programmable Frequency Output
Power-Down Modes

APPLICATIONS

Cable and Satellite Systems
PC Multimedia
Digital Communications
Data and Video Modems
Cable Modem
Set-Top Boxes
Powerline Modem
Broadband Wireless Communication

GENERAL DESCRIPTION

The AD9873 integrates a complete 232 MHz quadrature digital transmitter and a multichannel receiver with four high-performance analog-to-digital converters (ADC) for various video and digital data signals. The AD9873 is designed for cable modem set-top box applications, where cost, size, power dissipation, and dynamic performance are critical attributes. A single external crystal is used to control all internal conversion and data processing cycles.

The transmit section of the AD9873 includes a high-speed direct digital synthesizer (DDS), a high-performance, high-speed 12-bit digital-to-analog converter (DAC), programmable clock multiplier circuitry, digital filters, and other digital signal processing functions, to form a complete quadrature digital up-converter device.

TxDAC+ is a registered trademark of Analog Devices, Inc.

REV. 0

Information furnished by Analog Devices is believed to be accurate and reliable. However, no responsibility is assumed by Analog Devices for its use, nor for any infringements of patents or other rights of third parties which may result from its use. No license is granted by implication or otherwise under any patent or patent rights of Analog Devices.

FUNCTIONAL BLOCK DIAGRAM

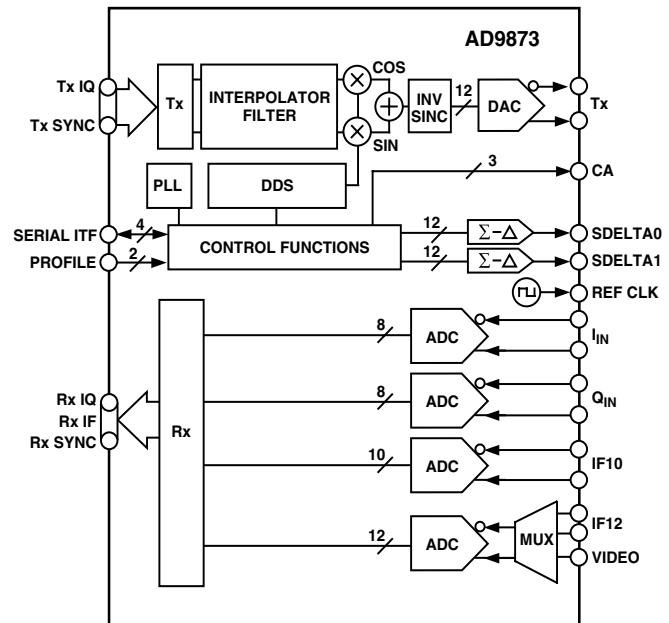

On the receiver side, two 8-bit ADCs are optimized for IQ demodulated “out-of band” signals. An on-chip 10-bit ADC is typically used as a direct IF input of 256 QAM modulated signals in cable modem applications. A second direct IF input and an auxiliary video input with automatic programmable clamp function are multiplexed to a high-performance 12-bit video ADC.

The chip’s programmable sigma-delta modulated outputs and an output clock may be used to control external components such as programmable gain amplifiers (PGA) and mixer stages. Three pins provide a direct interface to the AD8321/AD8323 programmable gain amplifier (PGA) cable driver.

The AD9873 is available in a space-saving 100-lead MQFP package.

TABLE OF CONTENTS

	Page		Page
FEATURES	1	TRANSMIT PATH (Tx)	24
GENERAL DESCRIPTION	1	Transmit Timing	24
SPECIFICATIONS	3	Data Assembler	24
ABSOLUTE MAXIMUM RATINGS	7	Half-Band Filters (HBFs)	25
THERMAL CHARACTERISTICS	7	Cascaded Integrator—COMB (CIC) Filter	25
EXPLANATION OF TEST LEVELS	7	Combined Filter Response	25
ORDERING GUIDE	7	Inverse SINC Filter (ISF)	27
DEFINITIONS OF TERMS	8	Tx Signal Level Considerations	28
PIN FUNCTION DESCRIPTIONS	9	Tx Throughput and Latency	28
PIN CONFIGURATION	10	D/A Converter	28
REGISTER BIT DEFINITIONS	12	PROGRAMMING/WRITING THE AD8321/AD8323	
TYPICAL PERFORMANCE CHARACTERISTICS ...	14	CABLE DRIVER AMPLIFIER GAIN CONTROL ...	29
Typical Power Consumption Characteristics	14	RECEIVE PATH (Rx)	30
Dual Sideband Transmit Spectrum	14	ADC Theory of Operation	30
Single Sideband Transmit Spectrum	15	Receive Timing	30
Typical QAM Transmit Performance Characteristics ..	16	Driving the Analog Inputs	30
Typical ADC Performance Characteristics	18	Op Amp Selection Guide	31
THEORY OF OPERATION	20	ADC Differential Inputs	31
Transmit Section	21	ADC Voltage References	31
OSC IN Clock Multiplier	21	Video Input	31
Receive Section	21	POWER AND GROUNDING CONSIDERATIONS ...	32
CLOCK AND OSCILLATOR CIRCUITRY	22	EVALUATION BOARD	33
PROGRAMMABLE CLOCK OUTPUT REF CLK ...	23	Hardware	33
SIGMA-DELTA OUTPUTS	23	Software	33
SERIAL INTERFACE FOR REGISTER CONTROL ...	23	OUTLINE DIMENSIONS	39
General Operation of the Serial Interface	23		
Instruction Byte	23		
Serial Interface Port Pin Description	24		
MSB/LSB Transfers	24		
Notes on Serial Port Operation	24		

SPECIFICATIONS ($V_{AS} = 3.3\text{ V} \pm 5\%$, $V_{DS} = 3.3\text{ V} \pm 10\%$, $f_{OSCIN} = 27\text{ MHz}$, $f_{SYSCLK} = 216\text{ MHz}$, $f_{MCLK} = 54\text{ MHz}$ ($M = 8$, $N = 4$), ADC Sample Rate derived from PLL f_{MCLK} , $R_{SET} = 10\text{ k}\Omega$, $75\ \Omega$ DAC Load)

Parameter	Temp	Test Level	Min	Typ	Max	Unit
SYSTEM CLOCK, DAC SAMPLING f_{SYSCLK} Frequency Range	Full	III			232	MHz
OSC IN and XTAL CHARACTERISTICS						
Frequency Range	Full	III	3		33	MHz
Duty Cycle	25°C	III	35	50	65	%
Input Capacitance	25°C	IV		3		pF
Input Resistance	25°C	IV		100		M Ω
MCLK OUT JITTER (f_{MCLK} Derived from PLL)	25°C	IV		6		ps rms
TxDAC CHARACTERISTICS ¹						
Resolution	N/A	N/A		12		Bits
Full-Scale Output Current	Full	III	2	4	20	mA
Gain Error (Using Internal Reference)	25°C	I	-3	0.14	+3	% FS
Output Offset	25°C	I	-1		+1	% FS
Reference Voltage (REFIO Level)	25°C	I	1.18	1.23	1.28	V
Differential Nonlinearity (DNL)	25°C	IV		± 2.5		LSB
Integral Nonlinearity (INL)	25°C	IV		± 8		LSB
Output Capacitance	25°C	IV		5		pF
Phase Noise @ 1 kHz Offset, 42 MHz	25°C	IV		-113		dBc/Hz
Output Voltage Compliance Range	Full	III	-0.5		+1.5	V
Wideband SFDR						
5 MHz Analog Out, $I_{OUT} = 4\text{ mA}$	25°C	IV		59		dBc
65 MHz Analog Out, $I_{OUT} = 4\text{ mA}$	25°C	IV		54		dBc
Narrowband SFDR ($\pm 100\text{ kHz}$ Window)						
65 MHz Analog Out, $I_{OUT} = 4\text{ mA}$	25°C	IV		79		dBc
Tx MODULATOR CHARACTERISTICS						
I/Q Offset	Full	III	50	55		dB
Pass Band Amplitude Ripple ($f < f_{IQCLK}/8$)	Full	III			± 0.1	dB
Pass Band Amplitude Ripple ($f < f_{IQCLK}/4$)	Full	III			± 0.5	dB
Stop Band Response ($f > f_{IQCLK} \times 3/4$)	Full	III			-63	dB
8-BIT ADC CHARACTERISTICS						
Resolution	N/A	N/A		8		Bits
Conversion Rate	Full	III			16.5	MHz
Pipeline Delay	N/A	N/A		3.5		ADC Cycles
DC Accuracy						
Differential Nonlinearity	25°C	IV		± 0.5		LSB
Integral Nonlinearity	25°C	IV		± 0.5		LSB
Offset Error for Each 8-Bit ADC	25°C	IV		± 0.75		% FSR
Gain Error for Each 8-Bit ADC	25°C	IV		± 4		% FSR
Offset Matching Between 8-Bit ADCs	Full	IV		± 3		LSB
Gain Matching Between 8-Bit ADCs	Full	IV		± 4.5		LSB
Analog Input						
Input Voltage Range	Full	IV		1		V p-p
Input Capacitance	25°C	IV		1.4		pF
Differential Input Resistance	25°C	IV		4		k Ω
Aperture Delay	25°C	IV		2.0		ns
Aperture Uncertainty (Jitter)	25°C	IV		1.2		ps rms
Input Bandwidth (-3 dB)	25°C	IV		90		MHz
Input Referred Noise	25°C	IV		600		μV
Reference Voltage Error						
REFT8-REFB8 (0.5 V)	25°C	I		± 4	± 92	mV
Dynamic Performance ($A_{IN} = -0.5\text{ dB FS}$, $f = 5\text{ MHz}$)						
Signal-to-Noise and Distortion Ratio (SINAD)	Full	II	43.5	48		dB

AD9873—SPECIFICATIONS

Parameter	Temp	Test Level	Min	Typ	Max	Unit
8-BIT ADC CHARACTERISTICS (Continued)						
Dynamic Performance ($A_{IN} = -0.5$ dB FS, $f = 5$ MHz)						
Effective Number of Bits (ENOB)	Full	II	6.9	7.68		Bits
Effective Number of Bits (ENOB) ²	Full	IV		7.68		Bits
Signal-to-Noise Ratio (SNR)	Full	II	43.5	48		dB
Total Harmonic Distortion (THD)	Full	II		-66	-57	dB
Spurious Free Dynamic Range (SFDR)	Full	II	58	64		dB
Differential Phase	25°C	IV		<0.1		Degree
Differential Gain	25°C	IV		1		LSB
10-BIT ADC CHARACTERISTICS						
Resolution	N/A	N/A		10		Bits
Conversion Rate	Full	III			33	MHz
Pipeline Delay	N/A	N/A		5.5		ADC Cycles
DC Accuracy						
Differential Nonlinearity	25°C	IV		±0.75		LSB
Integral Nonlinearity	25°C	IV		±0.5		LSB
Offset Error	25°C	IV		±0.5		% FSR
Gain Error	25°C	IV		±3		% FSR
Analog Input						
Input Voltage Range	Full	IV		2		V p-p
Input Capacitance	25°C	IV		1.4		pF
Differential Input Resistance	25°C	IV		4		kΩ
Aperture Delay	25°C	IV		2.0		ns
Aperture Uncertainty (Jitter)	25°C	IV		1.2		ps rms
Input Bandwidth (-3 dB)	25°C	IV		95		MHz
Input Referred Noise	25°C	IV		350		μV
Reference Voltage						
REFT10-REFB10 (1 V)	25°C	I		±6	±200	mV
Dynamic Performance ($A_{IN} = -0.5$ dB FS, $f = 5$ MHz)						
Signal-to-Noise and Distortion Ratio (SINAD)	Full	II	57.9	60.1		dB
Effective Number of Bits (ENOB)	Full	II	9.3	9.7		Bits
Effective Number of Bits (ENOB) ³	Full	IV		9.8		Bits
Signal-to-Noise Ratio (SNR)	Full	II	58.2	60.1		dB
Total Harmonic Distortion (THD)	Full	II		-75.8	-63.9	dB
Spurious Free Dynamic Range (SFDR)	Full	II	65.7	80		dB
Differential Phase	25°C	IV		<0.1		Degree
Differential Gain	25°C	IV		<1		LSB
12-BIT ADC CHARACTERISTICS						
Resolution	N/A	N/A		12		Bits
Conversion Rate	Full	III			33	MHz
Pipeline Delay	N/A	N/A		5.5		ADC Cycles
DC Accuracy						
Differential Nonlinearity	25°C	IV		±0.75		LSB
Integral Nonlinearity	25°C	IV		±1.5		LSB
Offset Error	25°C	IV		±1		% FSR
Gain Error	25°C	IV		±2		% FSR
Analog Input						
Input Voltage Range	Full	IV		2		V p-p
Input Capacitance	25°C	IV		1.4		pF
Differential Input Resistance	25°C	IV		4		kΩ
Aperture Delay	25°C	IV		2.0		ns
Aperture Uncertainty (Jitter)	25°C	IV		1.2		ps rms
Input Bandwidth (-3 dB)	25°C	IV		85		MHz
Input Referred Noise	25°C	IV		75		μV
Reference Voltage						
REFT12-REFB12 (1 V)	25°C	I		±6	±200	mV

Parameter	Temp	Test Level	Min	Typ	Max	Unit
12-BIT ADC CHARACTERISTICS (Continued)						
Dynamic Performance ($A_{IN} = -0.5$ dB FS, $f = 5$ MHz)						
Signal-to-Noise and Distortion Ratio (SINAD)	Full	III	62.3	65		dB
Signal-to-Noise and Distortion Ratio (SINAD) ³	Full	IV		67.4		dB
Effective Number of Bits (ENOB)	Full	III	10.0	10.5		Bits
Effective Number of Bits (ENOB) ³	Full	IV		10.8		Bits
Signal-to-Noise Ratio (SNR)	Full	III	63.3	65.3		dB
Signal-to-Noise Ratio (SNR) ³	Full	IV		67.4		dB
Total Harmonic Distortion (THD)	Full	III		-77.6	-65.4	dB
Total Harmonic Distortion (THD) ³	Full	IV		-77.6		dB
Spurious Free Dynamic Range (SFDR)	Full	III	65.7	80		dB
Spurious Free Dynamic Range (SFDR) ³	Full	IV		80		dB
Differential Phase	25°C	IV		<0.1		Degree
Differential Gain	25°C	IV		<1		LSB
VIDEO CLAMP INPUT						
Input Voltage Range	Full	IV		2		V
Clamp Current Positive	25°C	IV		1.3		mA
Clamp Droop Current	25°C	IV		2		μA
Clamp Level Offset Programming Range	25°C	III	256	512	2032	LSB
Clamp Level Resolution	25°C	IV		16		LSB
Carrier Rejection Filter Bandwidth (-3 dB)	25°C	IV		0.6		MHz
Dynamic Performance ($A_{IN} = -0.5$ dB FS, $f = 5$ MHz)						
Signal-to-Noise and Distortion Ratio (SINAD)	Full	IV		52		dB
Effective Number of Bits (ENOB)	Full	IV		8.34		Bits
Signal-to-Noise Ratio (SNR)	Full	IV		61.0		dB
Total Harmonic Distortion (THD)	Full	IV		-53.0		dB
Spurious Free Dynamic Range (SFDR)	Full	IV		55.0		dB
Differential Phase	25°C	IV		<0.1		Degree
Differential Gain	25°C	IV		<8		LSB
CHANNEL-TO-CHANNEL ISOLATION						
Tx DAC-to-ADC Isolation						
(5 MHz Analog Output)						
Isolation Between Tx and 8-Bit ADCs	25°C	IV		>80		dB
Isolation Between Tx and 10-Bit ADC	25°C	IV		>85		dB
Isolation Between Tx and 12-Bit ADC	25°C	IV		>90		dB
ADC-to-ADC Isolation						
($A_{IN} = -0.5$ dB FS, $f = 5$ MHz)						
Isolation Between IF12 and Video	25°C	III	70	>70		dB
Isolation Between IF10 and IF12	25°C	IV		>80		dB
Isolation Between Q in and IF10	25°C	IV		>80		dB
Isolation Between Q in and I Inputs	25°C	IV		>70		dB
TIMING CHARACTERISTICS (20 pF Load)						
Wake-Up Time	N/A	N/A			200	t_{MCLK} Cycles
Minimum RESET Pulswidth Low (t_{RL})	N/A	N/A		5		t_{MCLK} Cycles
Digital Output Rise/Fall Time	25°C	III	2.8		4	ns
Tx/Rx Interface						
MCLK Frequency (f_{MCLK})	25°C	III			66	MHz
TxSYNC/TxIQ Set Up Time (t_{SU})	25°C	III	3			ns
TxSYNC/TxIQ Hold Time (t_{HD})	25°C	III	3			ns
RxSYNC/RxIQ/IF to Valid Time (t_{TV})	25°C	III			5.2	ns
RxSYNC/RxIQ/IF Hold Time (t_{HT})	25°C	III	0.2			ns
Serial Control Bus						
SCLK Frequency (f_{SCLK})	Full	III			15	MHz
Clock Pulsewidth High (t_{PWH})	Full	III	30			ns
Clock Pulsewidth Low (t_{PWL})	Full	III	30			ns
Clock Rise/Fall Time	Full	III			1	ms
Data/Chip-Select Setup Time (t_{DS})	Full	III	25			ns
Data Hold Time (t_{DH})	Full	III	0			ns
Data Valid Time (t_{DV})	Full	III			30	ns

AD9873—SPECIFICATIONS

Parameter	Temp	Test Level	Min	Typ	Max	Unit
CMOS LOGIC INPUTS						
Logic “1” Voltage	25°C	III	2.0			V
Logic “0” Voltage	25°C	III			0.8	V
Logic “1” Current	25°C	III			12	μA
Logic “0” Current	25°C	III			12	μA
Input Capacitance	25°C	IV		3		pF
CMOS LOGIC OUTPUTS (1 mA Load)						
Logic “1” Voltage	25°C	III	2.4			V
Logic “0” Voltage	25°C	III			0.4	V
POWER SUPPLY						
Analog Supply Current I_{AS}	25°C	II		91	115	mA
Digital Supply Current I_{DS}						
Full Operating Conditions ⁴ (Register 02h = 00h)	25°C	IV		250		mA
Zero Input Tx ⁴ (Register 02h = 00h)	25°C	II		175	205	mA
25% Tx Burst Duty Cycle ⁴ (Register 02h = 00h)	25°C	IV		210		mA
Power-Down Digital Tx (Register 02h = 20h)	25°C	II		42	55	mA
Power Supply Rejection (Differential Signal)						
Tx DAC	25°C	IV		<0.25		% FS
8-Bit ADC	25°C	IV		<0.004		% FS
10-Bit ADC	25°C	IV		<0.002		% FS
12-Bit ADC	25°C	IV		<0.0004		% FS

NOTES

¹Single tone generated by applying a 1.6875 MHz sine signal to the Q Channel and the 90 degree phase shifted (cosine) signal to the I Channel.

²Sampling directly with $f_{OSCCIN}/2$. No degradation due to Clock Multiplier PLL. ADC Clock Select Register 08h, Bits 5 and 7 set to “1.”

³Sampling directly with f_{OSCCIN} . No degradation due to Clock Multiplier PLL. ADC Clock Select Register 08h, Bits 5 and 7 set to “1.”

⁴See performance graph TPC 2 for power saving in burst mode operation.

ABSOLUTE MAXIMUM RATINGS*

Power Supply (VAS, VDS)	3.9 V
Digital Output Current	5 mA
Digital Inputs	-0.3 V to DRVDD + 0.3 V
Analog Inputs	-0.3 V to AVDD (IQ) +0.3 V
Operating Temperature	0°C to 70°C
Maximum Junction Temperature	150°C
Storage Temperature	-65°C to +150°C
Lead Temperature (Soldering 10 sec)	300°C

*Absolute maximum ratings are limiting values, to be applied individually, and beyond which the serviceability of the circuit may be impaired. Functional operability under any of these conditions is not necessarily implied. Exposure of absolute maximum rating conditions for extended periods of time may affect device reliability.

EXPLANATION OF TEST LEVELS

- I - 100% production tested.
- II - Devices are 100% production tested at 25°C and guaranteed by design and characterization testing for commercial operating temperature range (0°C to 70°C).
- III - Parameter is guaranteed by design and/or characterization testing.
- IV - Parameter is a typical value only.
- N/A - Test level definition is not applicable.

THERMAL CHARACTERISTICS

Thermal Resistance

100-Lead MQFP

$$\theta_{JA} = 40.5^{\circ}\text{C}/\text{W}$$

ORDERING GUIDE

Model	Temperature Range	Package Description	Package Option
AD9873JS	0°C to 70°C	Metric Quad Flatpack (MQFP)	S-100C
AD9873-EB		Evaluation Board	

CAUTION

ESD (electrostatic discharge) sensitive device. Electrostatic charges as high as 4000 V readily accumulate on the human body and test equipment and can discharge without detection. Although the AD9873 features proprietary ESD protection circuitry, permanent damage may occur on devices subjected to high-energy electrostatic discharges. Therefore, proper ESD precautions are recommended to avoid performance degradation or loss of functionality.



AD9873

DEFINITIONS OF TERMS

DIFFERENTIAL NONLINEARITY ERROR (DNL, NO MISSING CODES)

An ideal converter exhibits code transitions that are exactly 1 LSB apart. DNL is the deviation from this ideal value. Guaranteed no missing codes to 10-bit resolution indicates that all 1024 codes respectively, must be present over all operating ranges.

INTEGRAL NONLINEARITY ERROR (INL)

Linearity error refers to the deviation of each individual code from a line drawn from “negative full scale” through “positive full scale.” The point used as “negative full scale” occurs 1/2 LSB before the first code transition. “Positive full scale” is defined as a level 1 1/2 LSB beyond the last code transition. The deviation is measured from the middle of each particular code to the true straight line.

PHASE NOISE

Single-sideband phase noise power density is specified relative to the carrier (dBc/Hz) at a given frequency offset (1 kHz) from the carrier. Phase noise can be measured directly in single tone transmit mode with a spectrum analyzer that supports noise marker measurements. It detects the relative power between the carrier and the offset (1 kHz) sideband noise and takes the resolution bandwidth (rbw) into account by subtracting $10 \log(\text{rbw})$. It also adds a correction factor that compensates for the implementation of the resolution bandwidth, log display and detector characteristic.

OUTPUT COMPLIANCE RANGE

The range of allowable voltage at the output of a current-output DAC. Operation beyond the maximum compliance limits may cause either output stage saturation, resulting in nonlinear performance or breakdown.

SPURIOUS-FREE DYNAMIC RANGE (SFDR)

The difference, in dB, between the rms amplitude of the DACs output signal (or ADC’s input signal) and the peak spurious signal over the specified bandwidth (Nyquist bandwidth unless otherwise noted).

PIPELINE DELAY (LATENCY)

The number of clock cycles between conversion initiation and the associated output data being made available.

OFFSET ERROR

First transition should occur for an analog value 1/2 LSB above negative full scale. Offset error is defined as the deviation of the actual transition from that point.

GAIN ERROR

The first code transition should occur at an analog value 1/2 LSB above negative full scale. The last transition should occur for an analog value 1 1/2 LSB below the nominal full scale. Gain error is the deviation of the actual difference between first and last code transitions and the ideal difference between first and last code transitions.

APERTURE DELAY

Aperture delay is a measure of the Sample-and-Hold Amplifier (SHA) performance and specifies the time delay between the rising edge of the sampling clock input to when the input signal is held for conversion.

APERTURE UNCERTAINTY (JITTER)

Aperture jitter is the variation in aperture delay for successive samples and is manifested as noise on the input to the ADC.

SIGNAL-TO-NOISE + DISTORTION (SINAD) RATIO

SINAD is the ratio of the rms value of the measured input signal to the rms sum of all other spectral components below the Nyquist frequency, including harmonics but excluding dc. The value for SINAD is expressed in decibels.

EFFECTIVE NUMBER OF BITS (ENOB)

For a sine wave, SINAD can be expressed in terms of the number of bits. Using the following formula,

$$N = (\text{SINAD} - 1.76) \text{ dB} / 6.02$$

it is possible to obtain a measure of performance expressed as N , the effective number of bits.

SIGNAL-TO-NOISE RATIO (SNR)

SNR is the ratio of the rms value of the measured input signal to the rms sum of all other spectral components below the Nyquist frequency, excluding harmonics and dc. The value for SNR is expressed in decibels.

TOTAL HARMONIC DISTORTION (THD)

THD is the ratio of the rms sum of the first six harmonic components to the rms value of the measured input signal and is expressed as a percentage or in decibels.

POWER SUPPLY REJECTION

Power supply rejection specifies the converters maximum full-scale change when the supplies are varied from nominal to minimum and maximum specified voltages.

CHANNEL-TO-CHANNEL ISOLATION (CROSSTALK)

In an ideal multichannel system, the signal in one channel will not influence the signal level of another channel. The channel-to-channel isolation specification is a measure of the change that occurs to a grounded channel as a full-scale signal is applied to another channel.

PIN FUNCTION DESCRIPTIONS

Pin No.	Mnemonic	Pin Function	Pin No.	Mnemonic	Pin Function
1, 84, 87 92, 95	AVDD	Analog Supply Voltage	64	CA DATA	Cable Amplifier Control Data Output
2, 21, 70	DRGND	Pin Driver Digital Ground	65	$\overline{\text{CA ENABLE}}$	Cable Amplifier Control Enable Output
3, 22, 72	DRVDD	Pin Driver Digital Supply Voltage	66	DVDD SD	Supply Voltage Sigma Delta
4–15	IF11–IF0	Multiplexed Output of IF10- and IF12-Bit ADCs	67	SDELTA1	Sigma Delta Output Stream 1
16–19	Rx IQ 3 –Rx IQ 0	Multiplexed Output of I and Q 8-Bit ADCs	68	SDELTA0	Sigma Delta Output Stream 0
20	Rx SYNC	Demultiplexer Synchronization Output for IF and IQ ADCs	69	DGND SD	Ground Sigma Delta
23	MCLK	Master Clock Output Demultiplexer	71	REF CLK	Programmable Reference Clock Output Derived from MCLK
24, 33, 38	DVDD	Digital Supply Voltage	73	AVDD IQ	Analog Supply 8-Bit ADCs
25, 34, 39, 40	DGND	Digital Ground	74, 77, 80	AGND IQ	Analog Ground 8-Bit ADCs
26	Tx SYNC	Synchronization Input for Transmitter	75	REFB8	Bottom Reference Decoupling IQ 8-Bit ADC's Reference
27–32	Tx IQ 5 –Tx IQ 0	Multiplexed I and Q Input Data for Transmitter (Two's Complement)	76	REFT8	Top Reference Decoupling IQ 8-Bit ADC's Reference
35, 36	PROFILE[1:0]	Profile Selection Inputs	78	I IN–	Inverting I Analog Input
37	$\overline{\text{RESET}}$	Master Reset Input, Reset applies for all Interfaces and Registers	79	I IN+	Noninverting I Analog Input
41	SCLK	Serial Interface Input Clock	81	Q IN–	Inverting Q Analog Input
42	$\overline{\text{CS}}$	Serial Interface Chip Select	82	Q IN+	Noninverting Q Analog Input
43	SDIO	Serial Interface Data I/O	83, 88, 91, 96, 99	AGND	Analog Ground 10-/12-Bit ADC
44	SDO	Serial Interface Data Output	85	REFB10	Bottom Reference Decoupling IF 10-Bit ADC's Reference
45	DGND Tx	Digital Ground Tx Section	86	REFT10	Top Reference Decoupling IF 10-Bit ADC's Reference
46	DVDD Tx	Digital Supply Voltage Tx	89	IF10–	Noninverting IF10 Analog Input
47	$\overline{\text{PWR DOWN}}$	Transmit Power-Down Control Input	90	IF10+	Inverting IF10 Analog Input
48	REFIO	DAC Bandgap requires 0.1 μF Capacitor to Ground	93	REFB12	Bottom Reference Decoupling IF 12-Bit ADC's Reference
49	FSADJ	Full-Scale DAC Current Output Adjust with External Resistor	94	REFT12	Top Reference Decoupling IF 12-Bit ADC's Reference
50	AGND Tx	Analog Ground Tx Section	97	IF12–	Inverting IF12 Analog Input
51	Tx–	Transmitter DAC Output–	98	IF12+	Noninverting IF12 Analog Input
52	Tx+	Transmitter DAC Output+	100	VIDEO IN	Single-Ended Video Input
53	AVDD Tx	Analog Supply Voltage Tx			
54	DGND PLL	PLL Digital Ground			
55	DVDD PLL	PLL Digital Supply Voltage			
56	AVDD PLL	PLL Analog Supply Voltage			
57	PLL FILTER	PLL Loop Filter Connection			
58	AGND PLL	PLL Analog Ground			
59	DGND OSC	Digital Ground Oscillator			
60	XTAL	Crystal Oscillator Inv. Output			
61	OSC IN	Oscillator Clock Input			
62	DVDD OSC	Digital Supply Oscillator			
63	CA CLK	Cable Amplifier Control Clock Output			

PIN CONFIGURATION

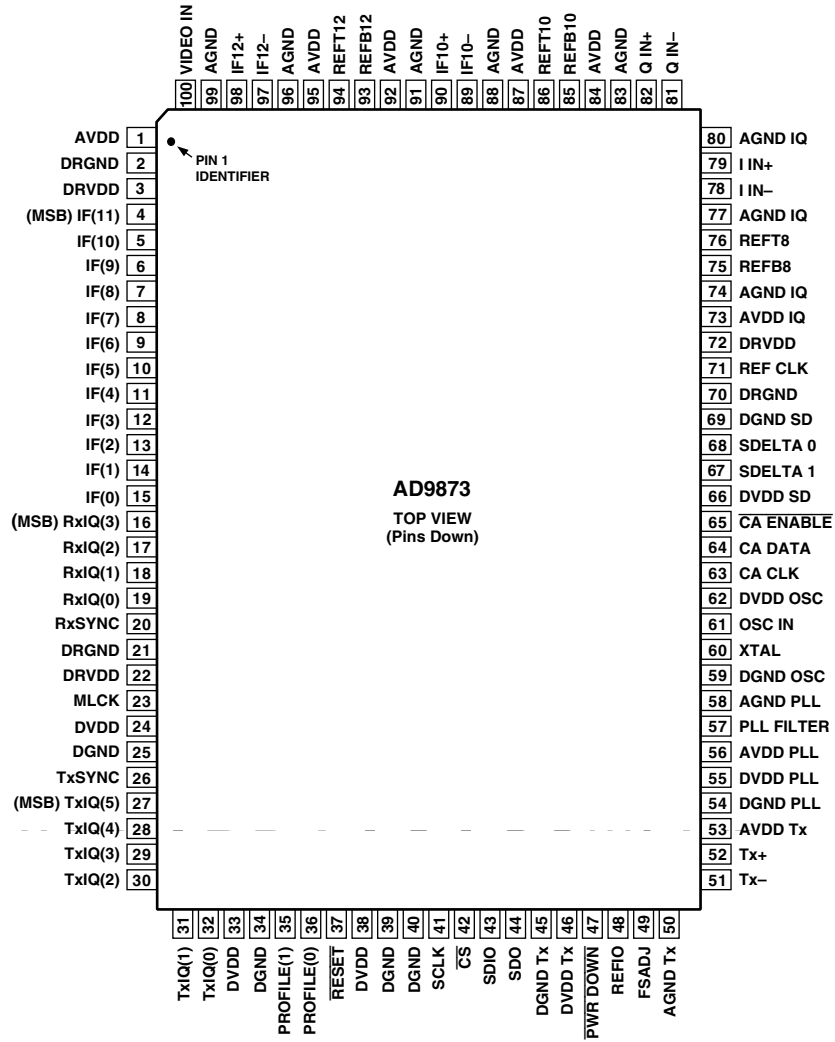

Table I. Register Map

Address (Hex)	Bit 7	Bit 6	Bit 5	Bit 4	Bit 3	Bit 2	Bit 1	Bit 0	Default (Hex)	Type
00	SDIO Bidirectional	LSB/MSB First	$\overline{\text{RESET}}$	OSC IN Multiplier M <4>	OSC IN Multiplier M <3>	OSC IN Multiplier M <2>	OSC IN Multiplier M <1>	OSC IN Multiplier M <0>	10	rw
01	PLL Lock Detect	OSC IN Divider N = 3 (4)	MCLK Divider R <5>	MCLK Divider R <4>	MCLK Divider R <3>	MCLK Divider R <2>	MCLK Divider R <1>	MCLK Divider R <0>	09	rw
02	Power-Down PLL	Power-Down DAC Tx	Power-Down Digital Tx	Power-Down 12-Bit ADC	Power-Down Reference 12-Bit ADC	Power-Down 10-Bit ADC	Power-Down Reference 10-Bit ADC	Power-Down 8-Bit ADC	00	rw
03	Sigma-Delta Output 0 Control Word <3:0> LSB				0	0	0	0	00	rw $\Sigma\Delta$
04	Sigma-Delta Output 0 Control Word <11:4> MSB								00	rw $\Sigma\Delta$
05	Sigma-Delta Output 1 Control Word <3:0> LSB				0	0	0	0	00	rw $\Sigma\Delta$
06	Sigma-Delta Output 1 Control Word <11:4> MSB								00	rw $\Sigma\Delta$
07	Video Input Enable	Clamp Level Control for Video Input <6:0>							20	rw ADC
08	ADC Clock Select	0	ADC Clock Select	0	0	0	Test 12-Bit ADC	Test 10-Bit ADC	00	rw ADC
09	0	0	0	0	0	0	0	0	00	rw
0A	0	0	0	0	0	0	0	0	00	rw
0B	0	0	0	0	0	0	0	0	00	rw
0C	0	0	0	0	Version <3:0>				0X	r
0D	0	0	0	0	0	0	0	0	00	r
0E	0	0	0	0	0	0	0	0	00	r
0F	0	0	Profile Select <1>	Profile Select <0>	0	Bypass Inv. Sinc Tx Filter	Spectral Inversion Tx	Single-Tone Tx Mode	00	rw Tx
10	Tx Frequency Turning Word Profile 0 <7:0>								00	rw Tx
11	Tx Frequency Turning Word Profile 0 <15:8>								00	rw Tx
12	Tx Frequency Turning Word Profile 0 <23:16>								00	rw Tx
13	Cable Driver Amplifier Gain Control Profile 0 <7:0>								00	rw Tx
14	Tx Frequency Turning Word Profile 1 <7:0>								00	rw Tx
15	Tx Frequency Turning Word Profile 1 <15:8>								00	rw Tx
16	Tx Frequency Turning Word Profile 1 <23:16>								00	rw Tx
17	Cable Driver Amplifier Gain Control Profile 1 <7:0>								00	rw Tx
18	Tx Frequency Turning Word Profile 2 <7:0>								00	rw Tx
19	Tx Frequency Turning Word Profile 2 <15:8>								00	rw Tx
1A	Tx Frequency Turning Word Profile 2 <23:16>								00	rw Tx
1B	Cable Driver Amplifier Gain Control Profile 2 <7:0>								00	rw Tx
1C	Tx Frequency Turning Word Profile 3 <7:0>								00	rw Tx
1D	Tx Frequency Turning Word Profile 3 <15:8>								00	rw Tx
1E	Tx Frequency Turning Word Profile 3 <23:16>								00	rw Tx
1F	Cable Driver Amplifier Gain Control Profile 3 <7:0>								00	rw Tx

"0" register bits should *not* be programmed with 1.

AD9873

REGISTER BIT DEFINITIONS

00h, Bits 0–4: OSC IN Multiplier–Register Address

This register field is used to program the on-chip multiplier (PLL) that generates the chip's high-frequency system clock, f_{SYSCLK} . For example, to multiply the external crystal clock f_{OSCIN} by 19 decimal, program register address 00h, Bits 5–1 as 13h. Default value is $M = 16 = 10h$. Valid entries range from $M = 1$ to 31. $M = 1$ (no PLL) requires a very stable, high-frequency clock at OSC IN. A changed f_{SYSCLK} frequency is stable (PLL locked) after a maximum of $200 f_{\text{MCLK}}$ cycles (= Wake-Up Time).

00h, Bit 5: $\overline{\text{RESET}}$

Writing a one to this bit resets the registers to their default values and restarts the chip. The $\overline{\text{RESET}}$ bit always reads back 0. Register address 00h bits are not cleared by this software reset. However, a low level at the $\overline{\text{RESET}}$ pin would force all registers, including all bits in address 00h, to their default state.

00h, Bit 6: LSB/MSB First

Active high indicates SPI serial port access of instruction byte and data registers is least significant bit (LSB) first. Default low indicates most significant bit (MSB) first format.

00h, Bit 7: SDIO Bidirectional

Default low indicates SPI serial port uses dedicated input/output lines (SDIO and SDO pin). High configures serial port as single line I/O (SDIO pin is used bidirectional).

01h, Bits 0–5: MCLK Divider

This register is used to divide the chip's master clock by R, where R is an integer between 2 and 63. The generated reference clock, REF CLK, can be used for external frequency-controlled devices. Default value is $R = 9$.

01h, Bit 6: OSC IN Divider

The OSC IN multiplier output clock can be divided by 4 or 3 to generate the chip's master clock. Active high indicates a divide ratio of $N = 3$. Default low configures a divide ratio of $N = 4$.

01h, Bit 7: PLL Lock Detect

If this bit is set to 1, REF CLK pin is disabled from the normal usage. In this mode REF CLK high signals that the internal phase lock loop (PLL) is in lock with CLK IN.

02h Bits 0–7: Power-Down

Sections of the chip that are not used can be put in a power saving mode when the corresponding bits are set to 1. This register has a default value of 00h with all sections active.

Bit 0: Power-Down 8-bit ADC powers down the 8-bit ADC and stops RxSYNC framing signal.

Bit 1: Power-Down 10-bit ADC reference powers down the internal 10-bit ADC reference.

Bit 2: Power-Down 10-bit ADC powers down the 10-bit ADC.

Bit 3: Power-Down 12-bit ADC reference powers down the internal 12-bit ADC reference.

Bit 4: Power-Down 12-bit ADC powers down the 12-bit ADC.

Bit 5: Power-Down Tx powers down the transmit section of the chip.

Bit 6: Power-Down DAC Tx powers down the DAC.

Bit 7: Power-Down PLL powers down the CLK IN Multiplier.

03h to 06h: Sigma-Delta Output Control Words

The Sigma-Delta Output Control Words –0 and –1 are 12 bits wide and split in MSB bits <11:4> and LSB bits <3:0>. Changes to the sigma-delta outputs take effect immediately for every MSB or LSB register write. Sigma-delta output control words have a default value of 0. The smaller the programmed values in these registers, the lower are the integrated (low-pass filtered) sigma delta output levels (straight binary format).

07h, Bits 0–6: Clamp Level Control for Video Input

A 7-bit clamp level offset can be set for the internal automatic clamp level control loop of the Video Input.

Clamp level offset = Clamp level control $\times 16$.

This register defaults to $32 = 20h$, which amounts to a clamp level offset of $512 \text{ LSB} = 200h$. Valid clamp level control values are 16 to 127.

07h, Bit 7: Video Input Enable

This bit controls the multiplexer to the 12-bit ADC and determines if IF12 input or Video input is used. The bit is default set to 0 for the IF12 input.

08h, Bit 0: Test 10-Bit ADC

Active high allows nonmultiplexed 10-bit ADC data only to be read at IF outputs. Output data changes at half MCLK clock rate. This bit defaults to 0.

08h, Bit 1: Test 12-Bit ADC

Active high allows nonmultiplexed 12-bit ADC data only to be read at IF outputs. Output data changes at half MCLK clock rate. This bit defaults to 0.

08h, Bit 5 and Bit 7: ADC Clock Select

Active high indicates that the frequency at OSC IN is directly used to sample the on chip ADCs. Default low indicates that the on chip ADCs generate their sampling frequencies from the internally generated master clock MCLK. Both Bit 5 and Bit 7 need to be programmed with the same values.

0Ch, Bits 0–3: Version

This register stores the die version of the chip. It can only be read.

0Fh, Bit 0: Single-Tone Tx Mode

Active high configures the AD9873 for single-tone applications. The AD9873 will supply a single frequency output as determined by the frequency tuning word (FTW) selected by the active profile. In this mode, the Tx IQ input data pins are ignored but should be tied high or low. Default value of single-tone Tx mode is 0 (inactive).

0Fh, Bit 1: Spectral Inversion Tx

When set to 1, inverted modulation is performed

$$(I \cos(\omega t) + Q \sin(\omega t)).$$

Default is logic zero, noninverted modulation

$$(I \cos(\omega t) - Q \sin(\omega t)).$$

0Fh, Bit 2: Bypass Inv Sinc Tx Filter

Active high, configures the AD9873 to bypass the SIN(X)/X compensation filter. Default value is 0 (inverse sinc filter enabled).

0Fh, Bit 4, Bit 5: Profile Select

The AD9873 quadrature digital upconverter is capable of storing four preconfigured modulation modes called profiles that define a transmit frequency tuning word and cable driver amplifier control. Profile Select bits <1:0> or PROFILE [1:0] pins program the current register profile to be used. Profile Select bits should always be 0 if PROFILE pins are used to switch between profiles. Using the Profile Select bits as a means of switching between different profiles requires the PROFILE pins to be tied low.

10h–1Fh: Burst Parameter***Tx Frequency Tuning Words***

The frequency tuning word (FTW) determines the DDS-generated carrier frequency (f_C) and is formed via a concatenation of register addresses. Bit 7 of register address 1Ah is the most significant bit of the profile 2-frequency tuning word. Bit 0 of register address 18h is the least significant bit of the profile 2-frequency tuning word.

The output frequency equation is given as:

$$f_C = (FTW \times f_{SYSCLK}) / 2^{24}.$$

Where $f_{SYSCLK} = M \times f_{OSCIN}$ and $FTW < 80\ 00\ 00\ h$

Changes to FTW bytes immediately take effect on active profiles.

Cable Driver Gain Control

The AD9873 dedicates three output pins that directly interface to the AD832x-family of gain programmable cable driver amplifier. This allows direct control of the cable driver's gain via the AD9873. New data is automatically sent to the cable driver amplifier whenever a new burst profile with different gain setting becomes active or when the gain contents of an active AD8321/AD8323 gain control register changes. Default value is 00h (lowest gain).

AD9873

Typical Performance Characteristics ($V_{AS} = 3.3\text{ V}$, $V_{DS} = 3.3\text{ V}$, $f_{OSCIN} = 27\text{ MHz}$, $f_{SYSCLK} = 216\text{ MHz}$, $f_{MCLK} = 54\text{ MHz}$ [M = 8, N = 4], ADC Sample Rate derived directly from f_{OSCIN} , $R_{SET} = 10\text{ k}\Omega$ [$I_{OUT} = 4\text{ mA}$], $75\ \Omega$ DAC Load, unless otherwise noted)

TYPICAL POWER CONSUMPTION CHARACTERISTICS (20 MHz Single Tone, unless otherwise noted)

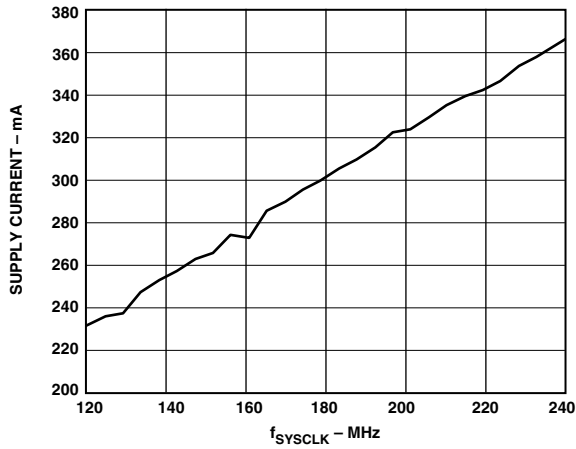

TPC 1. Power Consumption vs. Clock Speed, f_{SYSCLK}

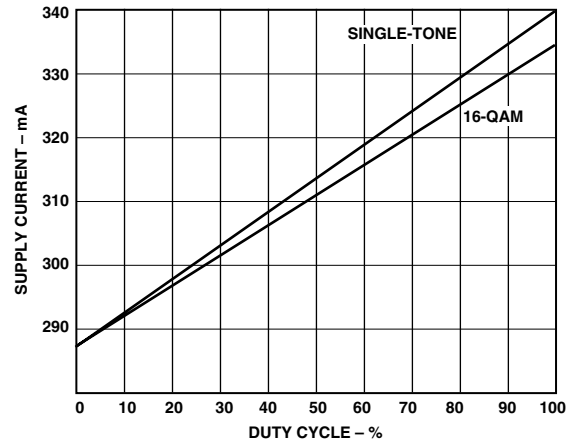

TPC 2. Power Consumption vs. Transmit Burst Duty Cycle

DUAL SIDEBAND TRANSMIT SPECTRUM (See Table IV for Dual-Tone Generation.)

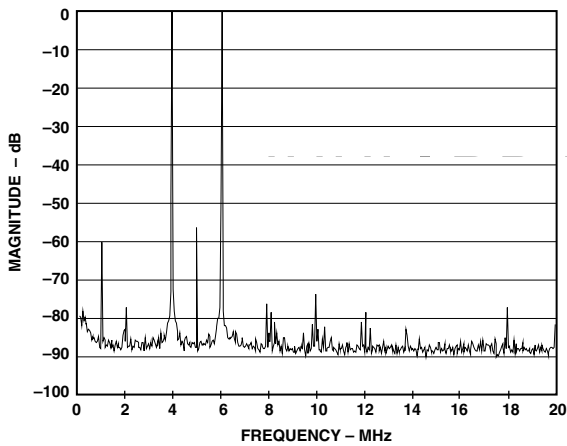

TPC 3a. Dual Sideband Spectral Plot, $f_c = 5\text{ MHz}$
 $f = 1\text{ MHz}$, $R_{SET} = 10\text{ k}\Omega$ ($I_{OUT} = 4\text{ mA}$), $RBW = 1\text{ kHz}$

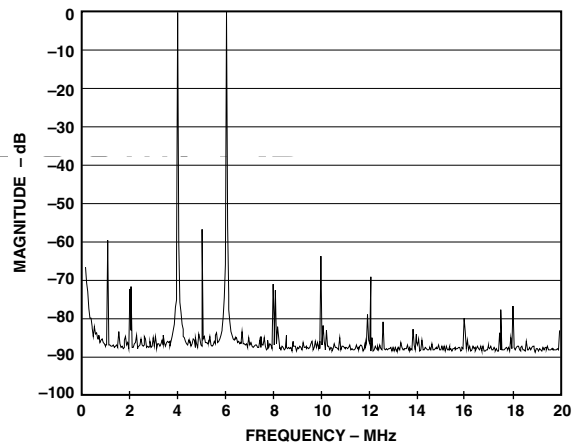

TPC 3b. Dual Sideband Spectral Plot, $f_c = 5\text{ MHz}$
 $f = 1\text{ MHz}$, $R_{SET} = 4\text{ k}\Omega$ ($I_{OUT} = 10\text{ mA}$), $RBW = 1\text{ kHz}$

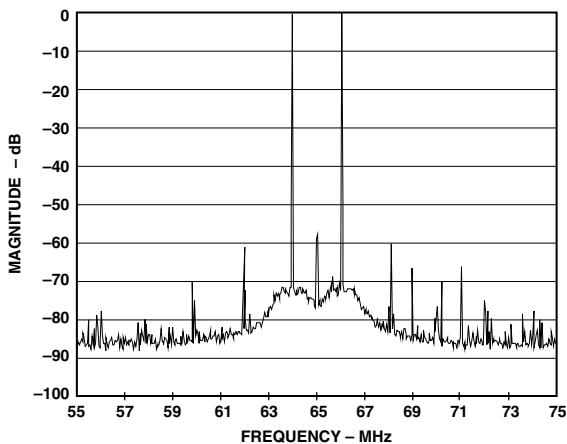

TPC 4a. Dual Sideband Spectral Plot, $f_c = 65\text{ MHz}$
 $f = 1\text{ MHz}$, $R_{SET} = 10\text{ k}\Omega$ ($I_{OUT} = 4\text{ mA}$), $RBW = 1\text{ kHz}$

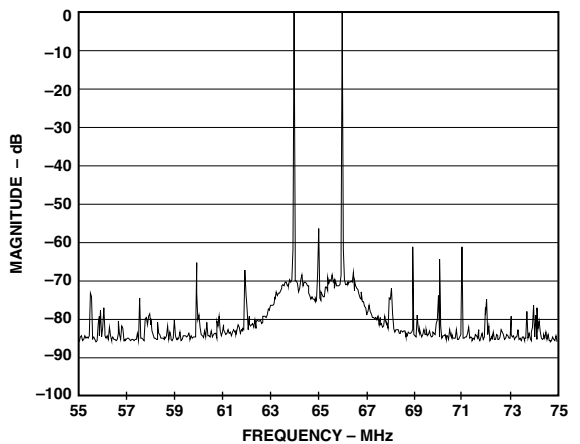

TPC 4b. Dual Sideband Spectral Plot, $f_c = 65\text{ MHz}$
 $f = 1\text{ MHz}$, $R_{SET} = 4\text{ k}\Omega$ ($I_{OUT} = 10\text{ mA}$), $RBW = 1\text{ kHz}$

SINGLE SIDEBAND TRANSMIT SPECTRUM

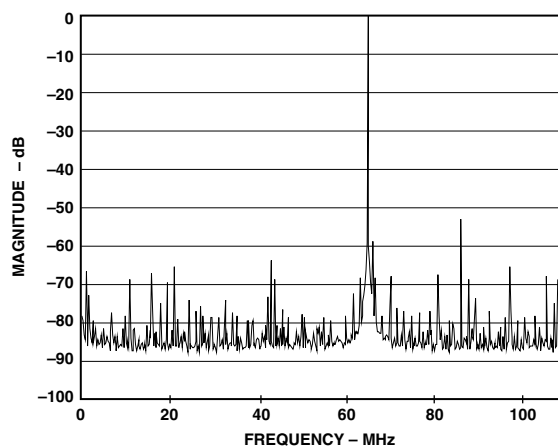

TPC 5a. Single Sideband @ 65 MHz, RBW = 2 kHz
 $f_C = 66$ MHz, $f = 1$ MHz, $R_{SET} = 10$ k Ω ($I_{OUT} = 4$ mA)

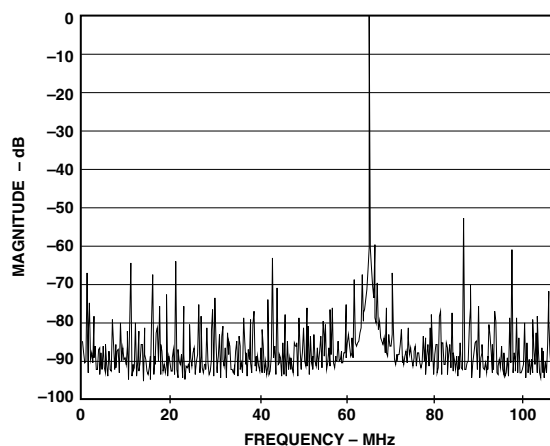

TPC 5b. Single Sideband @ 65 MHz, RBW = 2 kHz
 $f_C = 66$ MHz, $f = 1$ MHz, $R_{SET} = 4$ k Ω ($I_{OUT} = 10$ mA)

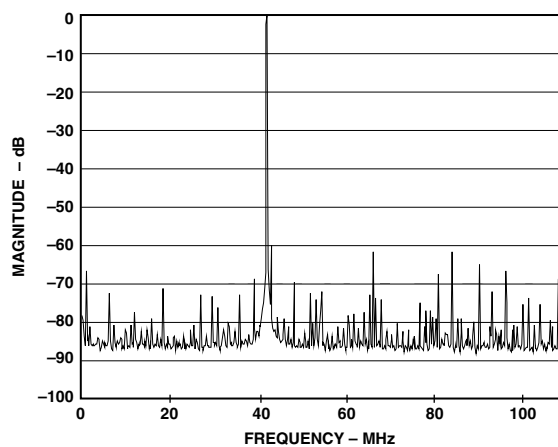

TPC 6a. Single Sideband @ 42 MHz, RBW = 2 kHz
 $f_C = 43$ MHz, $f = 1$ MHz, $R_{SET} = 10$ k Ω ($I_{OUT} = 4$ mA)

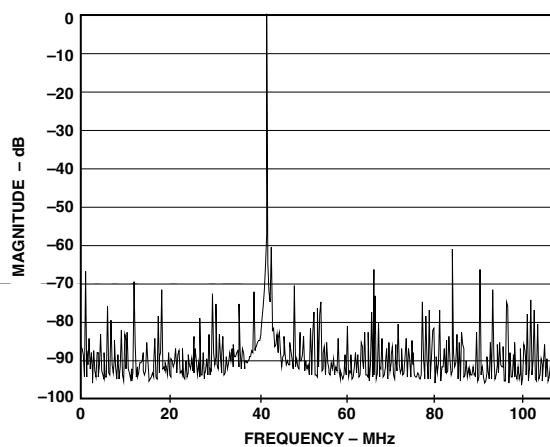

TPC 6b. Single Sideband @ 42 MHz, RBW = 2 kHz
 $f_C = 43$ MHz, $f = 1$ MHz, $R_{SET} = 4$ k Ω ($I_{OUT} = 10$ mA)

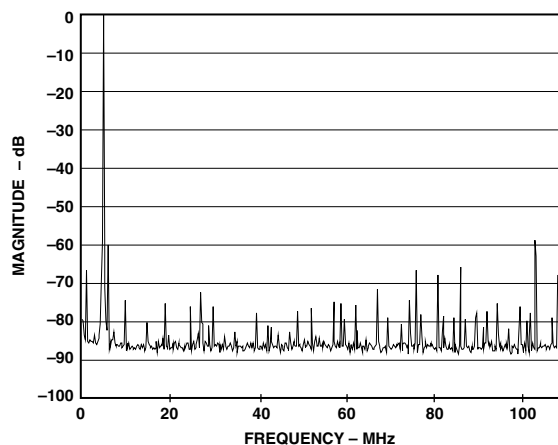

TPC 7a. Single Sideband @ 5 MHz, RBW = 2 kHz
 $f_C = 6$ MHz, $f = 1$ MHz, $R_{SET} = 10$ k Ω ($I_{OUT} = 4$ mA)

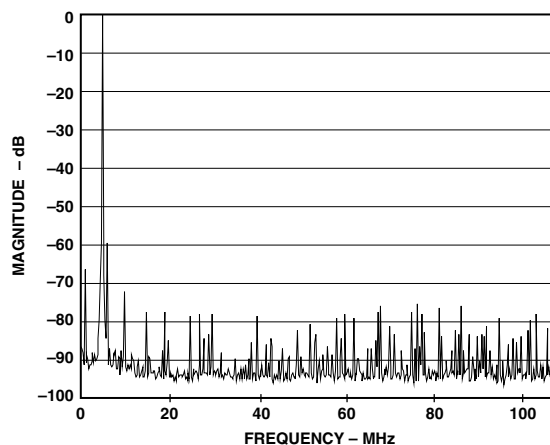

TPC 7b. Single Sideband @ 5 MHz, RBW = 2 kHz
 $f_C = 6$ MHz, $f = 1$ MHz, $R_{SET} = 4$ k Ω ($I_{OUT} = 10$ mA)

AD9873

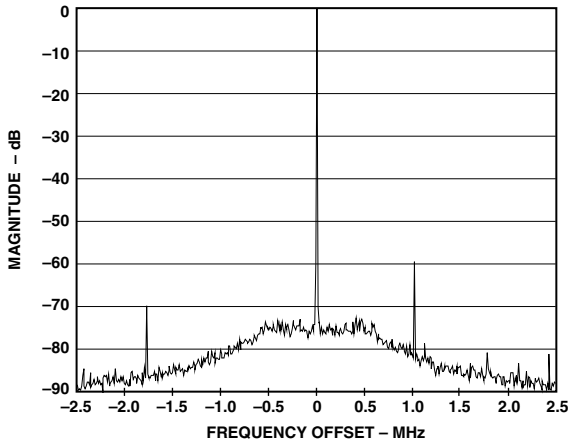

TPC 8a. Single Sideband @ 65 MHz, RBW = 500 Hz
 $f_C = 66$ MHz, $f = 1$ MHz, $R_{SET} = 10$ k Ω ($I_{OUT} = 4$ mA)

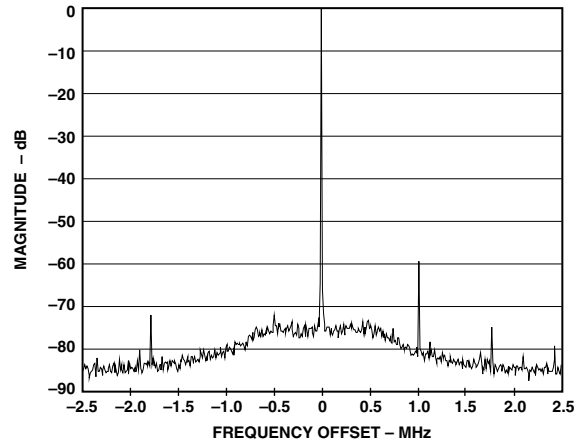

TPC 8b. Single Sideband @ 65 MHz, RBW = 500 Hz
 $f_C = 66$ MHz, $f = 1$ MHz, $R_{SET} = 4$ k Ω ($I_{OUT} = 10$ mA)

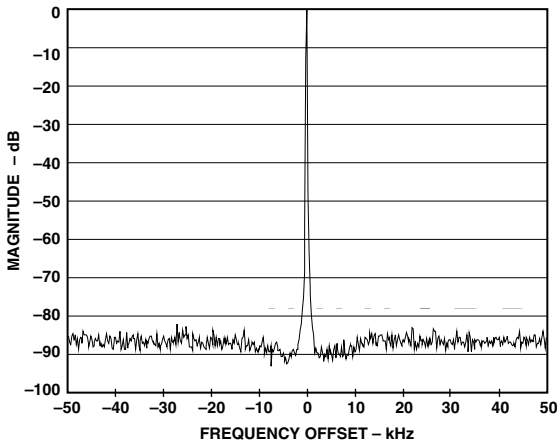

TPC 9. Single Sideband @ 65 MHz, RBW = 50 Hz
 $f_C = 66$ MHz, $f = 1$ MHz, $R_{SET} = 10$ k Ω ($I_{OUT} = 4$ mA)

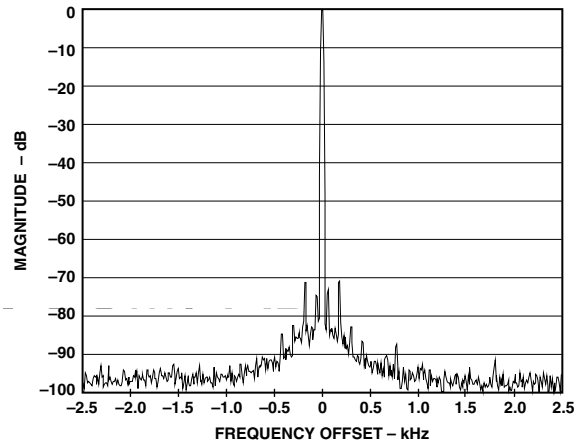

TPC 10. Single Sideband @ 65 MHz, RBW = 10 Hz
 $f_C = 66$ MHz, $f = 1$ MHz, $R_{SET} = 10$ k Ω ($I_{OUT} = 4$ mA)

TYPICAL QAM TRANSMIT PERFORMANCE CHARACTERISTICS

(16-QAM, 2.56 Mbit/s SINC Filter Enabled, Square Root Raised Cosine Filter with Alpha = 0.25, $R_{SET} = 4$ k Ω [$I_{OUT} = 10$ mA], $f_{SYSCLK} = 163.84$ MHz, $f_{OSCIN} = 20.48$ MHz [$M = 8$, $N = 4$].)

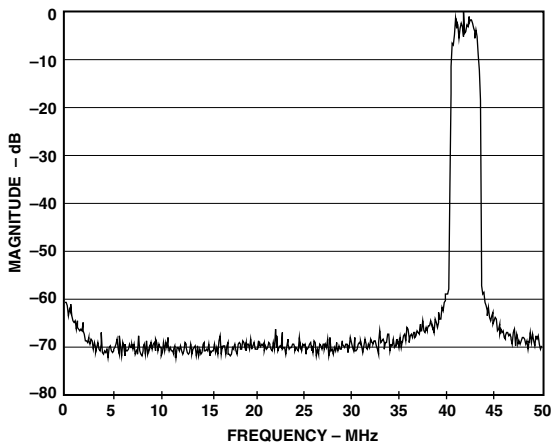

TPC 11. 16-QAM @ 42 MHz Spectral Plot, RBW = 1 kHz

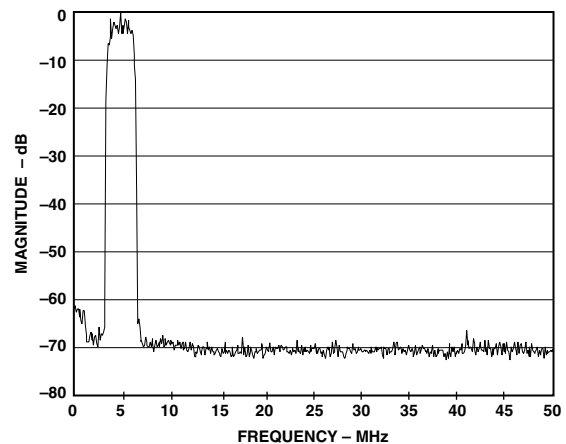

TPC 12. 16-QAM @ 5 MHz Spectral Plot, RBW = 1 kHz

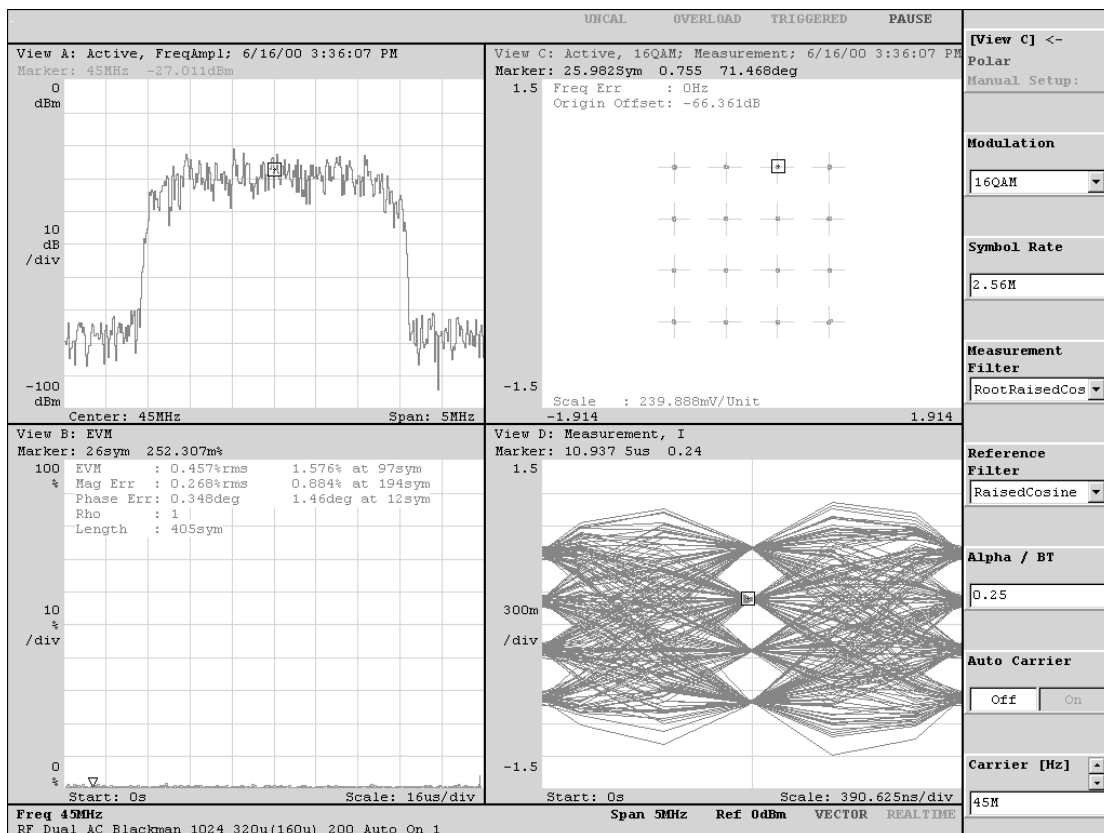

TPC 13. Tx Output 16-QAM Analysis

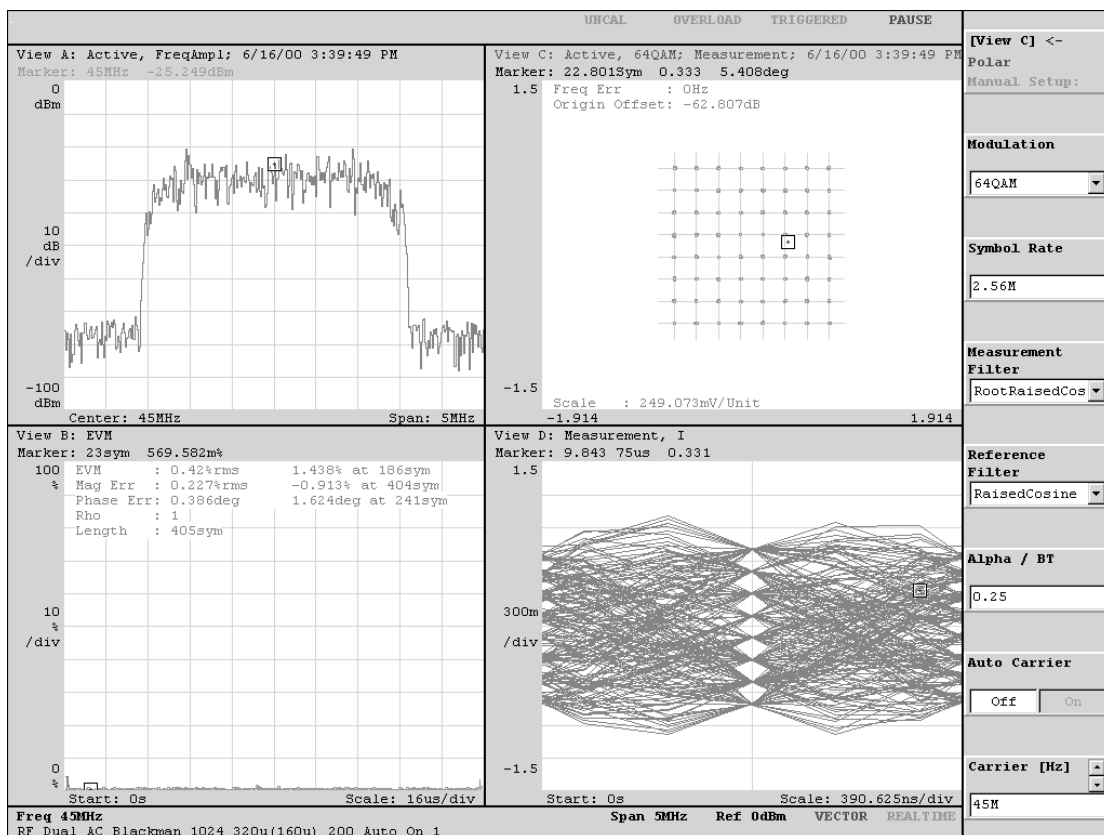

TPC 14. Tx Output 64-QAM Analysis

AD9873

TYPICAL ADC PERFORMANCE CHARACTERISTICS (ADC Sample Rate derived directly from $f_{OSCIN} = 27$ MHz [13.5 MSPS for 8-bit ADCs], Single-Tone 5 MHz Input Signal, unless otherwise noted.)

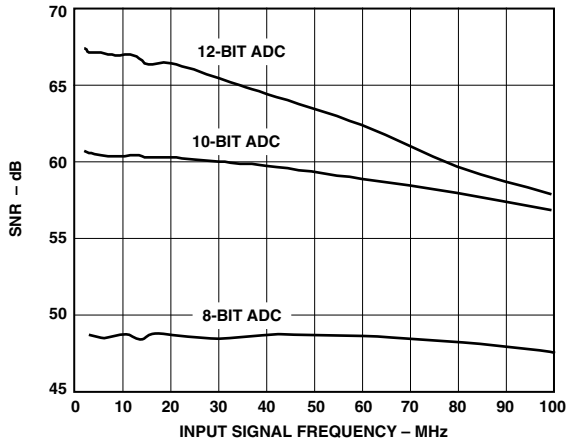

TPC 15. SNR vs. Input Frequency

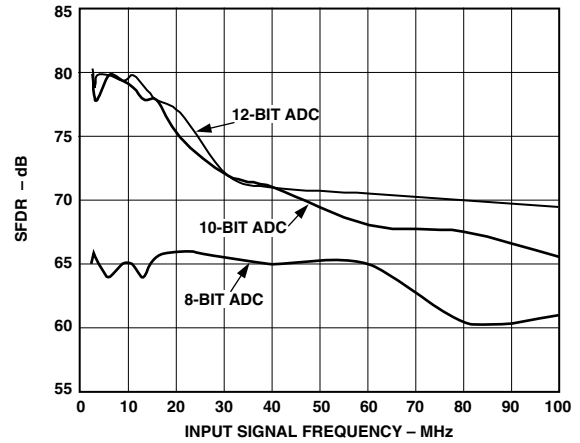

TPC 18. SFDR vs. Input Frequency

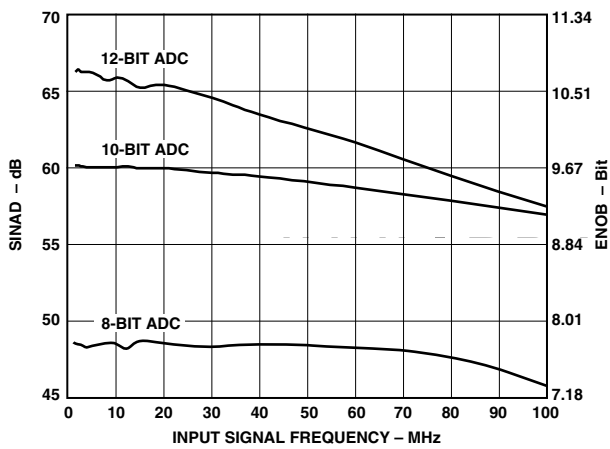

TPC 16. SINAD vs. Input Frequency

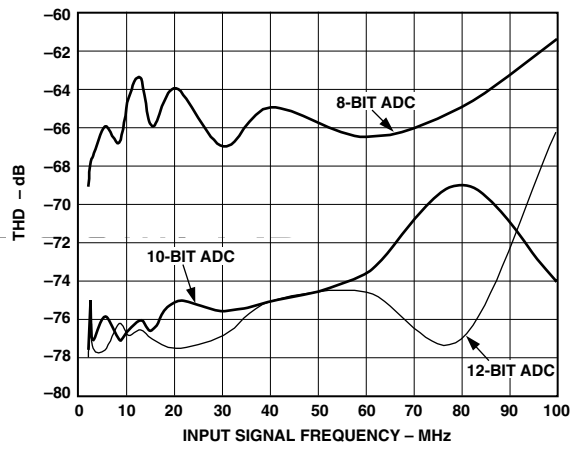

TPC 19. THD vs. Input Frequency

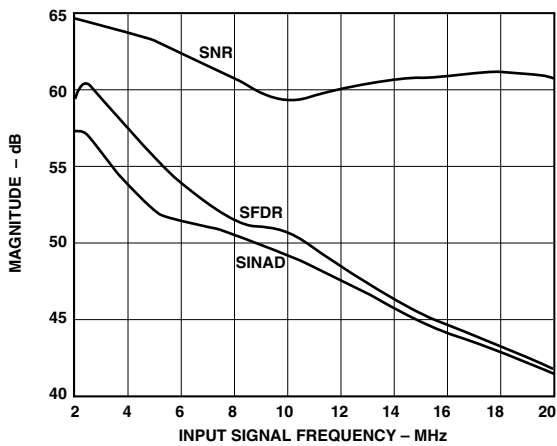

TPC 17. Video Input Characteristics vs. Input Frequency

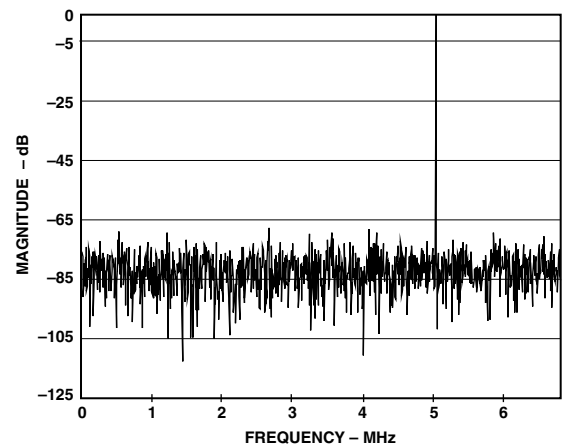

TPC 20. 8-Bit ADC Single-Tone Spectral Plot Using PLL (Input Frequency = 5 MHz, 2048 Point FFT)

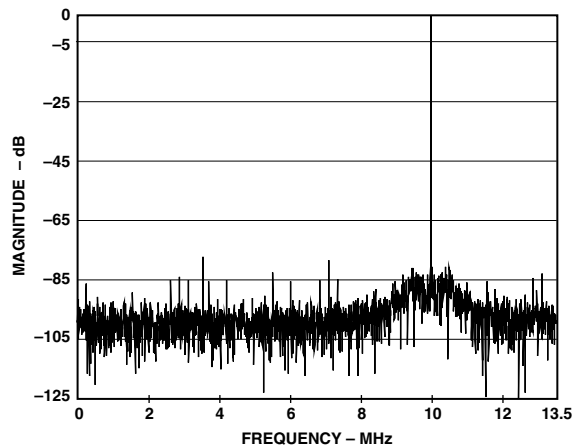

TPC 21. 12-Bit ADC Single-Tone Spectral Plot Using PLL (Input Frequency = 10 MHz, 4096 Point FFT)

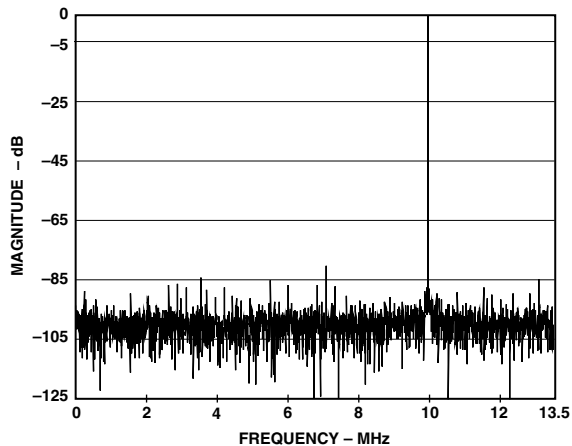

TPC 24. 12-Bit ADC Single-Tone Spectral Plot Without PLL (Input Frequency = 10 MHz, 4096 Point FFT)

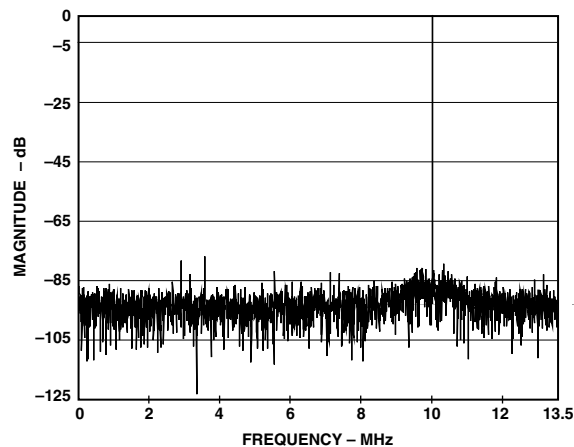

TPC 22. 10-Bit ADC Single-Tone Spectral Plot Using PLL (Input Frequency = 10 MHz, 4096 Point FFT)

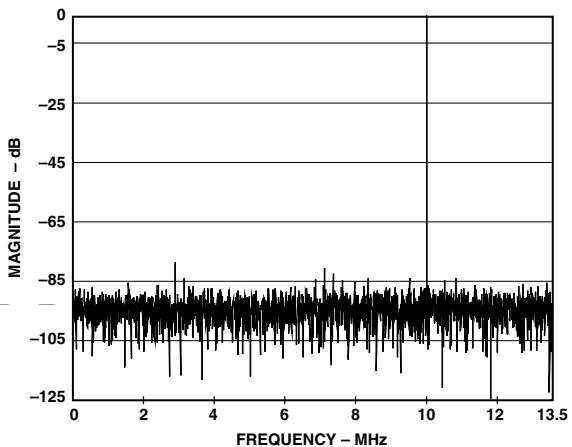

TPC 25. 10-Bit ADC Single-Tone Spectral Plot Without PLL (Input Frequency = 10 MHz, 4096 Point FFT)

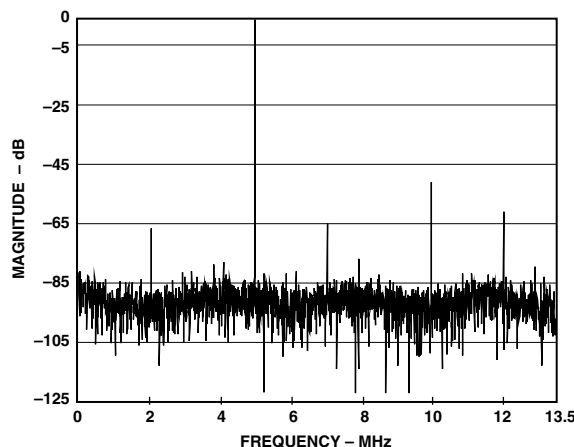

TPC 23. Video Input Single-Tone Spectral Plot Using PLL (Input Frequency = 5 MHz, 4096 Point FFT)

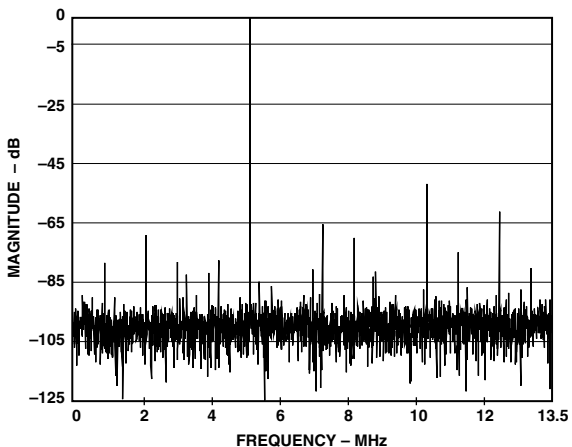

TPC 26. Video Input Single-Tone Spectral Plot Without PLL (Input Frequency = 5 MHz, 4096 Point FFT)

AD9873

THEORY OF OPERATION

To gain a general understanding of the AD9873 it is helpful to refer to Figure 1, which displays a block diagram of the device

architecture. The following is a general description of the device functionality. Later sections will detail each of the data path building blocks.

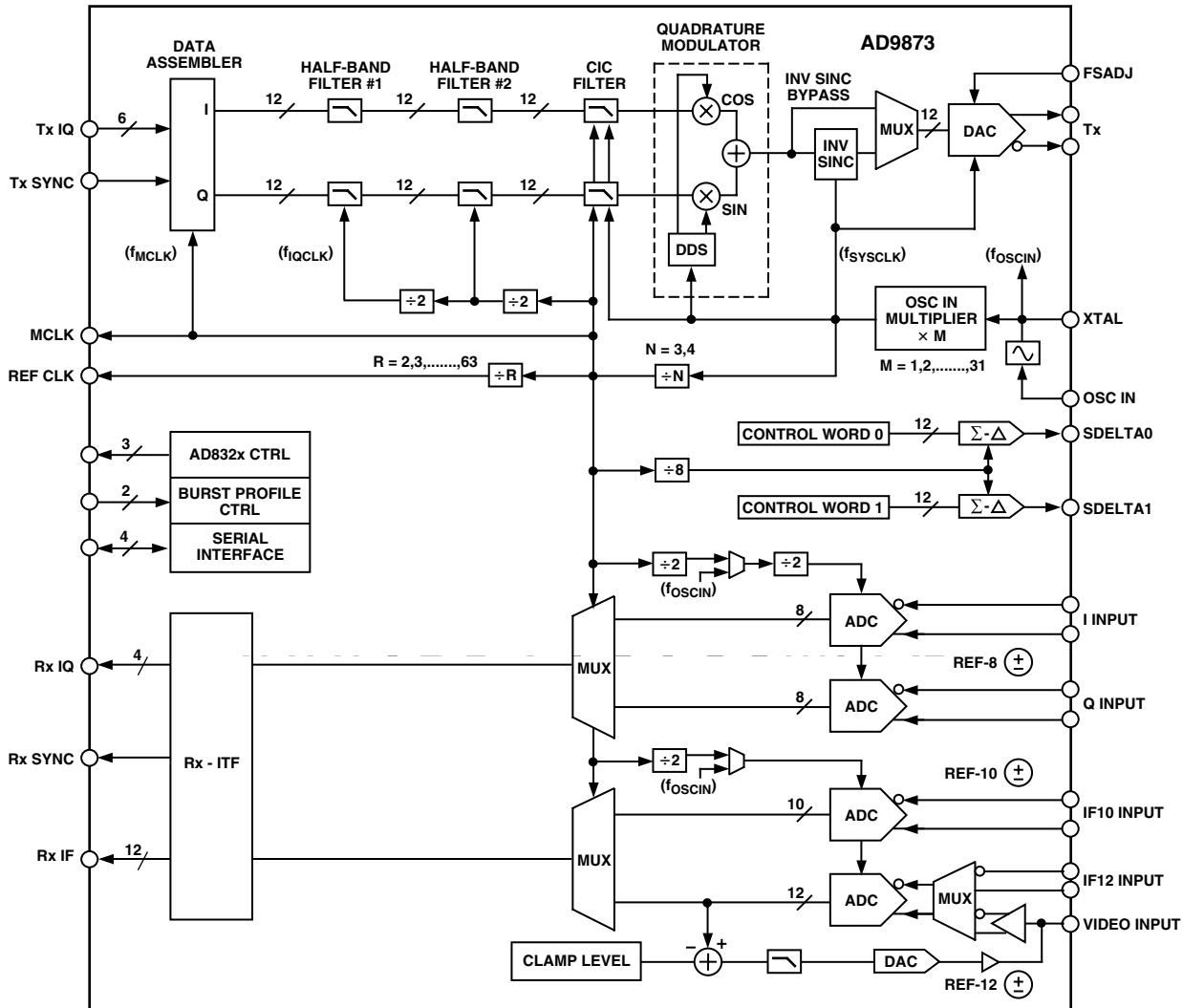

Figure 1. Block Diagram

Transmit Section

Modulation Mode Operation

The AD9873 accepts 6-bit words, which are strobed synchronous to the master clock MCLK into the Data Assembler. Tx SYNC signals the start of a transmit symbol. Two successive 6-bit words form a 12-bit symbol component. The incoming data is assumed to be complex, in that alternating 12-bit words are regarded as the inphase (I) and quadrature (Q) components of a symbol. Symbol components are assumed to be in two's complement format. The rate at which the 6-bit words are presented to the AD9873 will be referred to as the master clock rate (f_{MCLK}). The Data Assembler splits the incoming data words into separate I/Q data streams. The rate at which the I/Q data word pairs appear at the output of the Data Assembler will be referred to as the I/Q Sample Rate (f_{IQCLK}). Since two 6-bit input data words are used to construct each individual I and Q data paths, it should be apparent that the input 6-bit data rate f_{MCLK} is four times the I/Q sample rate ($f_{MCLK} = 4 \times f_{IQCLK}$).

Once through the Data Assembler, the I/Q data streams are fed through two half-band filters (half-band filters #1 and #2). The combination of these two filters results in a factor of four (4) increase of the sample rate. Thus, at the output of half-band filter #2, the sample rate is $4 \times f_{IQCLK}$. In addition to the sample rate increase, the half-band filters provide the low-pass filtering characteristic necessary to suppress the spectral images produced by the upsampling process.

After passing through the half-band filter stages, the I/Q data streams are fed to a Cascaded Integrator-Comb (CIC) filter. This filter is configured as an interpolating filter, which allows further upsampling rates of 3 or 4. The CIC filter, like the half-bands, has a built-in low-pass characteristic. Again, this provides for suppression of the spectral images produced by the upsampling process.

The digital quadrature modulator stage following the CIC filters is used to frequency-shift the baseband spectrum of the incoming data stream up to the desired carrier frequency (this process is known as *upconversion*).

The carrier frequency is numerically controlled by a Direct Digital Synthesizer (DDS). The DDS uses its internal reference clock (f_{SYSCLK}) to generate the desired carrier frequency with a high degree of precision. The carrier is applied to the I and Q multipliers in quadrature fashion (90° phase offset) and summed to yield a data stream that is at the modulated carrier.

It should be noted at this point that the incoming symbols have been converted from an input sample rate of f_{IQCLK} to an output sample rate of f_{SYSCLK} (see Figure 1). The modulated carrier is ultimately destined to serve as the input to the digital-to-analog converter (DAC) integrated on the AD9873.

The DAC output spectrum is distorted due to the intrinsic zero-order hold effect associated with DAC-generated signals. This distortion is deterministic and follows the familiar $SIN(X)/X$ (or SINC) envelope. Since the SINC distortion is predictable, it is also correctable. Hence, the presence of the optional Inverse SINC Filter preceding the DAC. This is a FIR filter, which has a transfer function conforming to the inverse of the SINC response. Thus, when selected, it modifies the incoming data stream so that the SINC distortion, which would otherwise appear in the DAC output spectrum, is virtually eliminated.

Single-Tone Output Transmit Operation

The AD9873 can be configured for frequency synthesis applications by writing the single-tone bit true, and applying a clock signal (e.g., Rx SYNC) to the Tx SYNC pin. In single-tone mode, the AD9873 disengages the modulator and preceding data path logic to output a spectrally pure single frequency sine wave. The AD9873 provides for a 24-bit frequency tuning word, which results in a tuning resolution of 12.9 Hz at a f_{SYSCLK} rate of 216 MHz. A good rule of thumb when using the AD9873 as a frequency synthesizer is to limit the fundamental output frequency to 30% of f_{SYSCLK} . This avoids generating aliases too close to the desired fundamental output frequency, thus minimizing the cost of filtering the aliases.

All applicable programming features of the AD9873 apply when configured in single-tone mode. These features include:

1. Frequency hopping via the PROFILE inputs and associated tuning word, which allows Frequency Shift Keying (FSK) modulation.
2. Ability to bypass the SIN(x)/x compensation filter.
3. Power-down modes.

OSC IN Clock Multiplier

As mentioned earlier, the output data is sampled at the rate of f_{SYSCLK} . Since the AD9873 is designed to operate at f_{SYSCLK} frequencies up to 232 MHz, there is the potential difficulty of trying to provide a stable input clock f_{OSCIN} . Although stable, high-frequency oscillators are available commercially, they tend to be cost prohibitive and create noise coupling issues on the printed circuit board. To alleviate this problem, the AD9873 has a built-in programmable clock multiplier and an oscillator circuit. This allows the use of a relatively low frequency (thus, less expensive) crystal or oscillator to generate the OSC IN signal. The low frequency OSC IN signal can then be multiplied in frequency by an integer factor of between 1 and 31, inclusive, to become the f_{SYSCLK} clock.

For DDS applications, the carrier is typically limited to about 30% of f_{SYSCLK} . For a 65 MHz carrier, the recommended system clock is above 216 MHz.

The OSC IN Multiplier function maintains clock integrity as evidenced by the AD9873's system phase noise characteristics of -113 dBc/Hz. External loop filter components consisting of a series resistor (1.3 k Ω) and capacitor (0.01 μ F) provide the compensation zero for the CLK IN Multiplier PLL loop. The overall loop performance has been optimized for these component values.

Receive Section

The AD9873 includes four high-speed, high-performance ADCs. Two matched 8-bit ADCs are optimized for analog IQ demodulated signals and can be sampled with up to 16.5 MSPS. A direct IF 10-bit ADC and a 12-bit ADC can digitize signals at a maximum sampling frequency of 33 MSPS. Input signal selection to the 12-bit ADC can be programmed to either direct IF or video (NTSC/PAL). A programmable automatic clamp control provides black level offset correction for video signals.

The ADC sampling frequency can either be derived directly from the OSC IN crystal or from the on-chip OSC IN Multiplier. For highest dynamic performance it is recommended to choose a OSC IN frequency that can be used to directly sample the ADCs.

AD9873

Digital 8-bit ADC outputs are multiplexed to one 4-bit bus, clocked by a frequency (f_{MCLK}) of four times the sampling rate whereas the 10- and 12-bit ADCs are multiplexed together to one 12-bit bus clocked by f_{MCLK} , which is two times their sampling frequency.

CLOCK AND OSCILLATOR CIRCUITRY

The AD9873's internal oscillator generates all sampling clocks from a simple, low-cost, series resonance, fundamental frequency quartz crystal. Figure 2 shows how the quartz crystal is connected between OSC IN (Pin 61) and XTAL (Pin 60) with parallel resonant load capacitors as specified by the crystal manufacturer. The internal oscillator circuitry can also be overdriven by a TTL level clock applied to OSC IN with XTAL left unconnected.

$$f_{OSC IN} = f_{MCLK} \times N/M$$

An internal phase locked loop (PLL) generates the DAC sampling frequency f_{SYSCLK} by multiplying OSC IN frequency M times

(register address 00h). The MCLK signal (Pin 23) f_{MCLK} is derived by dividing this PLL output frequency with the interpolation rate N of the CIC filter stages (register address 01h).

$$f_{SYSCLK} = f_{OSC IN} \times M$$

$$f_{MCLK} = f_{OSC IN} \times M/N$$

An external PLL loop filter (Pin 57) consisting of a series resistor and ceramic capacitor (Figure 15, $R1 = 1.3 \text{ k}\Omega$, $C12 = 0.01 \mu\text{F}$) is required for stability of the PLL. Also, a shield surrounding these components is recommended to minimize external noise coupling into the PLL's voltage controlled oscillator input (guard trace connected to AVDD PLL).

Figure 1 shows that ADCs are either directly sampled by a low-jitter clock at OSC IN or by a clock that is derived from the PLL output. Operating modes can be selected in register address 08. Sampling the ADCs directly with the OSC IN clock requires MCLK to be programmed to be twice the OSC IN frequency.

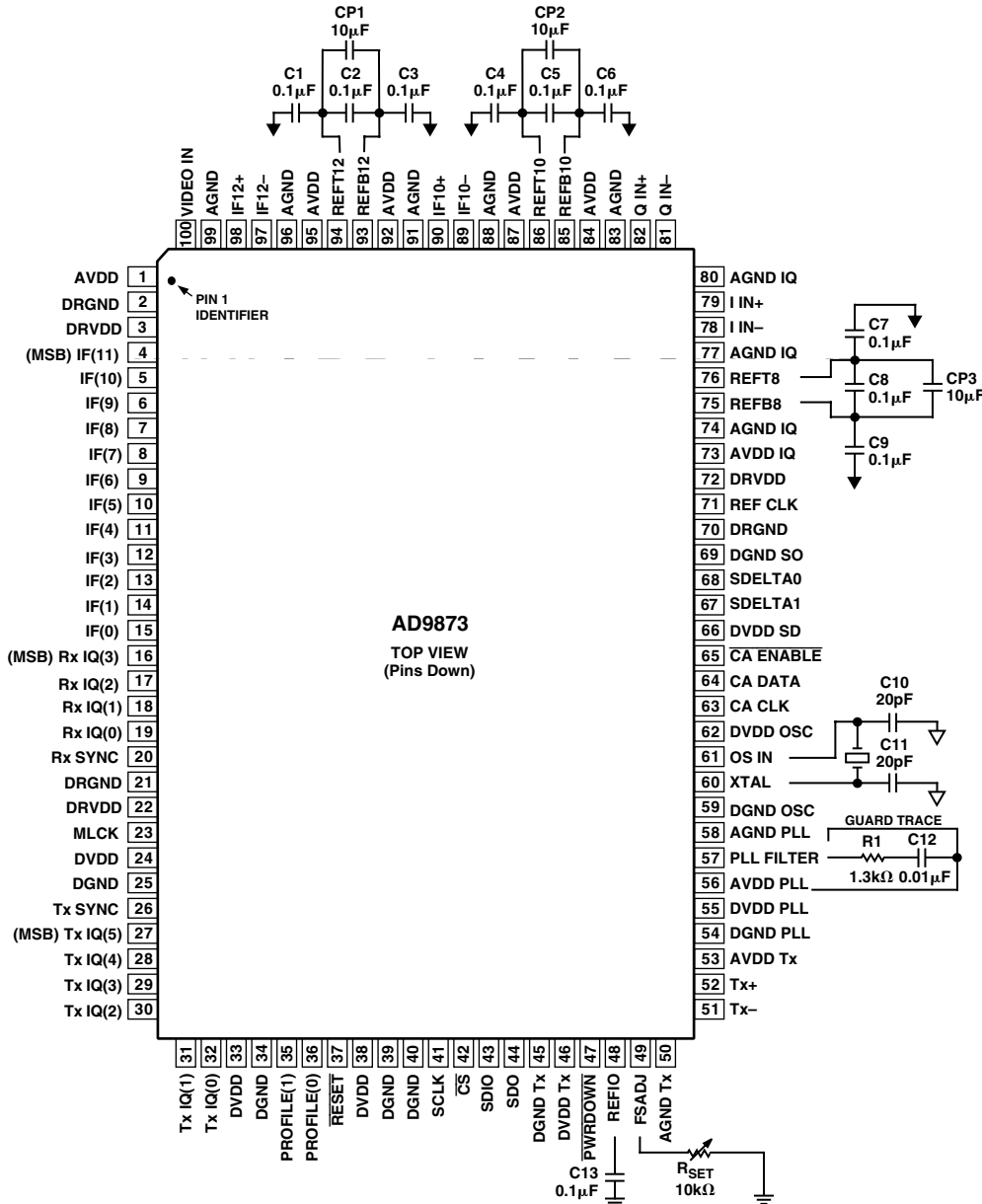

Figure 2. Basic Connections Diagram

PROGRAMMABLE CLOCK OUTPUT REF CLK

The AD9873 provides a frequency programmable clock output REF CLK (Pin 71). MCLK (f_{MCLK}) and the master clock divider ratio R stored in register address 01h determine its frequency:

$$f_{REF\ CLK} = f_{MCLK}/R$$

SIGMA-DELTA OUTPUTS

The AD9873 contains two independent sigma-delta outputs that when low-pass filtered generate level programmable DC voltages of:

$$V_{SD} = (\text{Sigma-Delta Code})/4096(V_{LOGIC1}) + V_{LOGIC0}$$

(Influenced by CMOS logic output levels.)

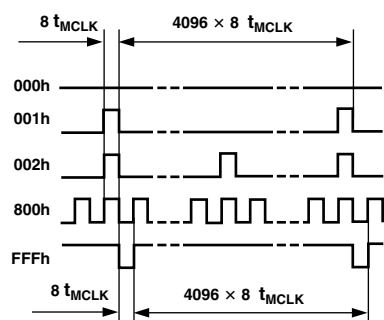

Figure 3. Sigma-Delta Output Signals

In cable modem set-top box applications the outputs can be used to control external variable gain amplifiers and RF tuners. A simple single-pole R-C low-pass filter provides sufficient filtering (see Figure 4).

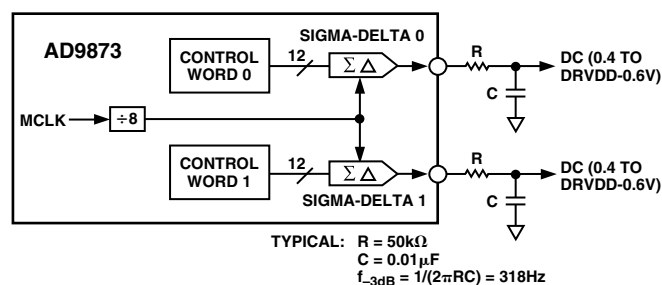

Figure 4. Sigma-Delta RC Filter

In more demanding applications where additional gain, level-shift or drive capability is required, a first or second order active filter might be considered for each sigma-delta output (see Figure 5).

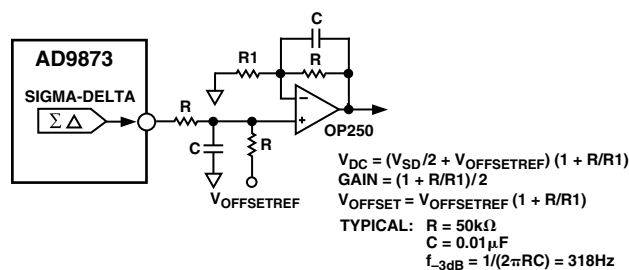

Figure 5. Sigma-Delta Active Filter With Gain and Offset

SERIAL INTERFACE FOR REGISTER CONTROL

The AD9873 serial port is a flexible, synchronous serial communications port allowing easy interface to many industry standard microcontrollers and microprocessors. The serial I/O is compatible with most synchronous transfer formats, including both the Motorola SPI and Intel SSR protocols. The interface allows read/write access to all registers that configure the AD9873. Single or multiple byte transfers are supported as well as MSB first or LSB first transfer formats. The AD9873's serial interface port can be configured as a single pin I/O (SDIO) or two unidirectional pins for in/out (SDIO/SDO).

General Operation of the Serial Interface

There are two phases to a communication cycle with the AD9873. Phase 1 is the instruction cycle, which is the writing of an instruction byte into the AD9873, coincident with the first eight SCLK rising edges. The instruction byte provides the AD9873 serial port controller with information regarding the data transfer cycle, which is Phase 2 of the communication cycle. The Phase 1 instruction byte defines whether the upcoming data transfer is read or write, the number of bytes in the data transfer and the starting register address for the first byte of the data transfer. The first eight SCLK rising edges of each communication cycle are used to write the instruction byte into the AD9873.

The remaining SCLK edges are for Phase 2 of the communication cycle. Phase 2 is the actual data transfer between the AD9873 and the system controller. Phase 2 of the communication cycle is a transfer of 1, 2, 3, or 4 data bytes as determined by the instruction byte. Normally, using one multibyte transfer is the preferred method. However, single byte data transfers are useful to reduce CPU overhead when register access requires one byte only. Registers change *immediately* upon writing to the last bit of each transfer byte.

Instruction Byte

The instruction byte contains the following information as shown in Table II:

Table II. Instruction Byte Information

MSB						LSB	
17	16	15	14	13	12	11	10
R/W	N1	N0	A4	A3	A2	A1	A0

R/W, Bit 7 of the instruction byte, determines whether a read or a write data transfer will occur after the instruction byte write. Logic high indicates read operation. Logic zero indicates a write operation. N1, N0, Bits 6 and 5 of the instruction byte, determine the number of bytes to be transferred during the data transfer cycle. The bit decodes are shown in the Table III.

Table III. Decode Bits

N1	N0	Description
0	0	Transfer 1 Byte
0	1	Transfer 2 Bytes
1	0	Transfer 3 Bytes
1	1	Transfer 4 Bytes

A4, A3, A2, A1, A0, Bits 4, 3, 2, 1, 0, of the instruction byte, determine which register is accessed during the data transfer portion of the communications cycle. For multibyte transfers, this address is the starting byte address. The remaining register addresses are generated by the AD9873.

AD9873

Serial Interface Port Pin Description

SCLK—Serial Clock. The serial clock pin is used to synchronize data to and from the AD9873 and to run the internal state machines. SCLK maximum frequency is 15 MHz. All data input to the AD9873 is registered on the rising edge of SCLK. All data is driven out of the AD9873 on the falling edge of SCLK.

CS—Chip Select. Active low input starts and gates a communication cycle. It allows more than one device to be used on the same serial communications lines. The SDO and SDIO pins will go to a high impedance state when this input is high. Chip select should stay low during the entire communication cycle.

SDIO—Serial Data I/O. Data is always written into the AD9873 on this pin. However, this pin can be used as a bidirectional data line. The configuration of this pin is controlled by Bit 7 of register address 0h. The default is logic zero, which configures the SDIO pin as unidirectional.

SDO—Serial Data Out. Data is read from this pin for protocols that use separate lines for transmitting and receiving data. In the case where the AD9873 operates in a single bidirectional I/O mode, this pin does not output data and is set to a high impedance state.

MSB/LSB Transfers

The AD9873 serial port can support both most significant bit (MSB) first or least significant bit (LSB) first data formats. This functionality is controlled by register address, 0h, Bit 6. The default is MSB first. When this bit is set active high, the AD9873 serial port is in LSB first format. That is, if the AD9873 is in LSB first mode, the instruction byte must be written from least significant bit to most significant bit. Multibyte data transfers in MSB format can be completed by writing an instruction byte that includes the register address of the most significant byte. In MSB first mode, the serial port internal byte address generator decrements for each byte required of the multibyte communication cycle. Multibyte data transfers in LSB first format can be completed by writing an instruction byte that includes the register address of the least significant byte. In LSB first mode, the serial port internal byte address generator increments for each byte required of the multibyte communication cycle.

The AD9873 serial port controller address will increment from 1Fh to 00h for multibyte I/O operations if the MSB first mode is active. The serial port controller address will decrement from 00h to 1Fh for multibyte I/O operations if the LSB first mode is active.

Notes on Serial Port Operation

The AD9873 serial port configuration bits reside in Bits 6 and 7 of register address 00h. It is important to note that the configuration changes *immediately* upon writing to the last bit of the register. For multibyte transfers, writing to this register may occur during the middle of a communication cycle. Care must be taken to compensate for this new configuration for the remaining bytes of the current communication cycle.

The same considerations apply to setting the reset bit in register address 00h. All other registers are set to their default values, but the software reset does not affect the bits in register address 00h.

It is recommended to use only single byte transfers when changing serial port configurations or initiating a software reset.

A write to Bits 1, 2, and 3 of address 00h with the same logic levels as for Bits 7, 6, and 5 (bit pattern: XY1001YX binary), allows the user to reprogram a lost serial port configuration and to reset the registers to their default values. A second write to address 00h with $\overline{\text{RESET}}$ bit low and serial port configuration as specified above (XY) reprograms the OSC IN Multiplier setting. A changed f_{SYSCLK} frequency is stable after a maximum of 200 f_{MCLK} cycles (= Wake-Up Time).

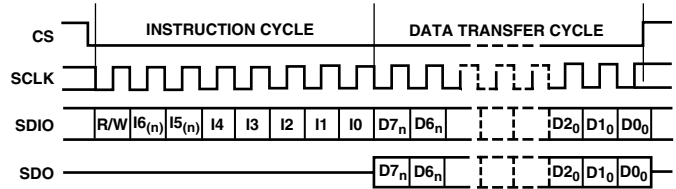

Figure 6a. Serial Register Interface Timing MSB-First

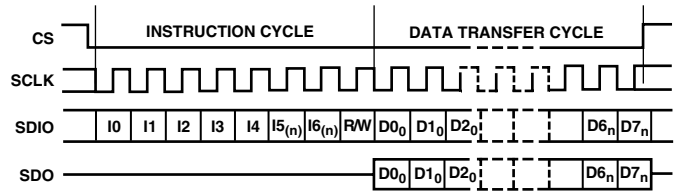

Figure 6b. Serial Register Interface Timing LSB-First

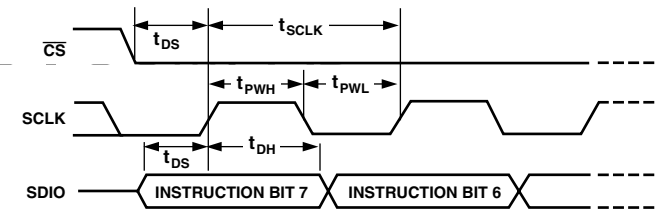

Figure 7. Timing Diagram for Register Write to AD9873

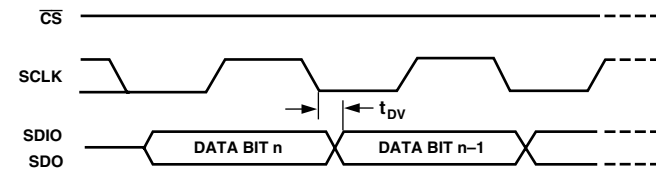

Figure 8. Timing Diagram for Register Read from AD9873

TRANSMIT PATH (Tx)

Transmit Timing

The AD9873 provides a master clock MCLK and expects 6-bit multiplexed Tx IQ data on each rising edge. Transmit symbols are framed with the Tx SYNC input. Tx SYNC high indicates the start of a transmit symbol. Four consecutive 6-bit data packages form a symbol (I MSB, I LSB, Q MSB, and Q LSB).

Data Assembler

The input data stream is representative complex data. Two 6-bit words form a 12-bit symbol component (two's complement format). Four input samples are required to produce one I/Q data pair. The I/Q sample rate f_{IQCLK} at the input to the first half-band filter is a quarter of the input data rate f_{MCLK} .

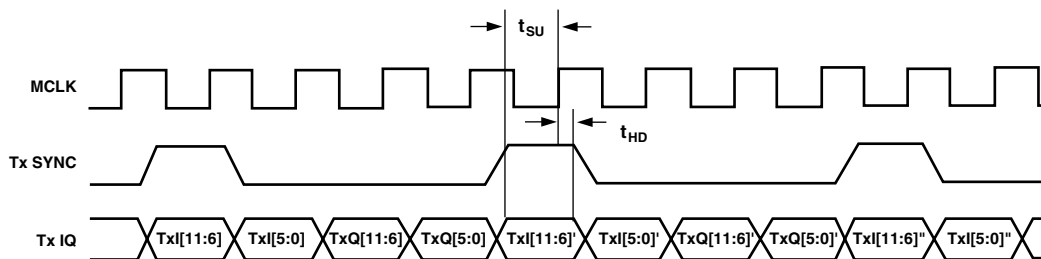

Figure 9. Transmit Timing Diagram

The I/Q sample rate f_{IQCLK} puts a bandwidth limit on the maximum transmit spectrum. This is the familiar Nyquist limit and is equal to one-half f_{IQCLK} which hereafter will be referred to as f_{NYQ} .

Half-Band Filters (HBFs)

HBF 1 is a 15-tap filter that provides a factor-of-two increase in sampling rate. HBF 2 is an 11-tap filter offering an additional factor-of-two increase in sampling rate. Together, HBF 1 and 2 provide a factor-of-four increase in the sampling rate ($4 \times f_{IQCLK}$ or $8 \times f_{NYQ}$).

In relation to phase response, both HBFs are linear phase filters. As such, virtually no phase distortion is introduced within the passband of the filters. This is an important feature as phase distortion is generally intolerable in a data transmission system.

Cascaded Integrator—COMB (CIC) Filter

A CIC filter is unlike a typical FIR filter in that it offers the flexibility to handle differing input and output sample rates (only in integer ratios, however). In the purest sense, a CIC filter can provide either an increase or a decrease in sample rate at the output relative to the input, depending on the architecture. If the integration stage precedes the comb stage, the CIC filter provides sample rate reduction (decimation). When the comb stage precedes the integrator stage, the CIC filter provides an increase in sample rate (interpolation). In the AD9873, the CIC filter is configured as a programmable interpolator and provides a sample rate increase by a factor of $R = 3$ or $R = 4$. In addition to the ability to provide a change in sample rate between input and output, a CIC filter also has an intrinsic low-pass frequency response characteristic. The frequency response of a CIC filter is dependent on three factors:

1. The rate change ratio, R .
2. The order of the filter, n .
3. The number of unit delays per stage, m .

It can be shown that the system function $H(z)$, of a CIC filter is given by:

$$H(z) = \left(\left(\frac{1}{R} \right) \frac{1 - z^{-Rm}}{1 - z^{-1}} \right)^n = \left(\left(\frac{1}{R} \right) \sum_{k=0}^{Rm-1} z^{-k} \right)^n$$

The form on the far right has the advantage of providing a result for $z = 1$ (corresponding to zero frequency or dc). The alternate form yields an indeterminate form (0/0) for $z = 1$, but is otherwise identical. The only variable parameter for the AD9873's CIC filter is R ; m and n are fixed at 1 and 3, respectively. Thus, the CIC system function for the AD9873 simplifies to:

$$H(z) = \left(\left(\frac{1}{R} \right) \frac{1 - z^{-R}}{1 - z^{-1}} \right)^3 = \left(\left(\frac{1}{R} \right) \sum_{k=0}^{R-1} z^{-k} \right)^3$$

The transfer function is given by:

$$|H(f)| = \left(\left(\frac{1}{R} \right) \frac{1 - e^{-j(2\pi fR)}}{1 - e^{-j2\pi f}} \right)^3 = \left| \left(\left(\frac{1}{R} \right) \frac{\sin(\pi fR)}{\sin(\pi f)} \right) \right|^3$$

The frequency response in this form is such that “ f ” is scaled to the output sample rate of the CIC filter. That is, $f = 1$ corresponds to the frequency of the output sample rate of the CIC filter. $H(f/R)$ will yield the frequency response with respect to the input sample of the CIC filter.

Combined Filter Response

The combined frequency response of HBF 1, HBF 2 and CIC is shown in Figure 10a to 10c and Figure 11a to 11c.

The usable bandwidth of the filter chain puts a limit on the maximum data rate that can be propagated through the AD9873. A look at the passband detail of the combined filter response (Figure 10d and Figure 11d) indicates that in order to maintain an amplitude error of no more than 1 dB, we are restricted to signals having a bandwidth of no more than about 60% of f_{NYQ} . Thus, in order to keep the bandwidth of the data in the flat portion of the filter passband, the user must oversample the baseband data by at least a factor of two prior to presenting it to the AD9873.

Note that without oversampling, the Nyquist bandwidth of the baseband data corresponds to the f_{NYQ} . As such, the upper end of the data bandwidth will suffer 6 dB or more of attenuation due to the frequency response of the digital filters. Furthermore, if the baseband data applied to the AD9873 has been pulse-shaped, there is an additional concern. Typically, pulse-shaping is applied to the baseband data via a filter having a raised cosine response. In such cases, an α value is used to modify the bandwidth of the data where the value of α is such that $0 \leq \alpha \leq 1$. A value of 0 causes the data bandwidth to correspond to the Nyquist bandwidth. A value of 1 causes the data bandwidth to be extended to twice the Nyquist bandwidth. Thus, with $2\times$ oversampling of the baseband data and $\alpha = 1$, the Nyquist bandwidth of the data will correspond with the I/Q Nyquist bandwidth. As stated earlier, this results in problems near the upper edge of the data bandwidth due to the frequency response of the filters. The maximum value of α that can be implemented is 0.45. This is because the data bandwidth becomes:

$$1/2(1 + \alpha) f_{NYQ} = 0.725 f_{NYQ}$$

which puts the data bandwidth at the extreme edge of the flat portion of the filter response.

AD9873

If a particular application requires an α value between 0.45 and 1, the user must oversample the baseband data by at least a factor of four.

The combined HB1, HB2, and CIC filter introduces, over the frequency range of the data to be transmitted, a worst-case droop of less than 0.2 dB.

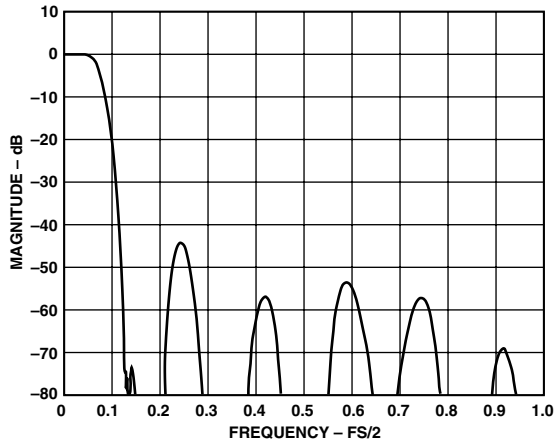

Figure 10a. Cascaded Filter 12x Interpolator ($N = 3$)

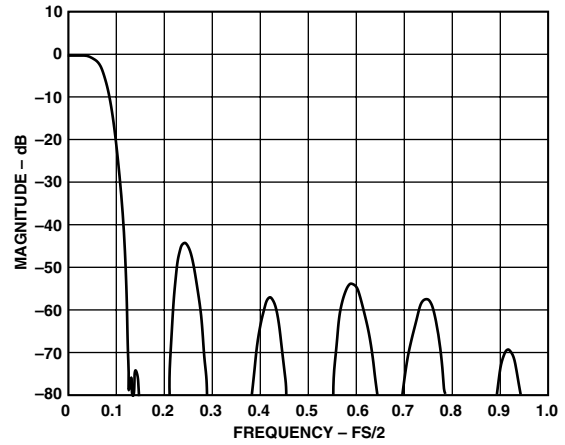

Figure 11a. Cascaded Filter 16x Interpolator ($N = 4$)

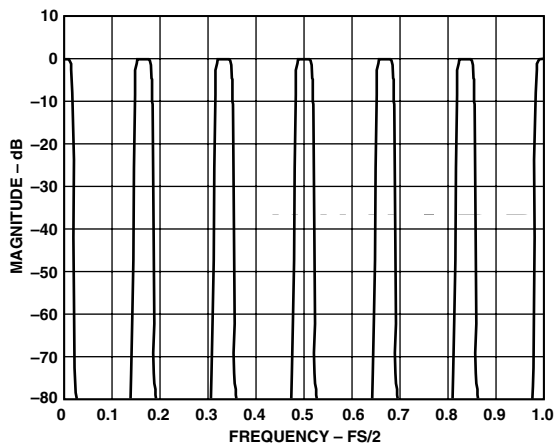

Figure 10b. Input Signal Spectrum ($N = 3$), $\alpha = 0.25$

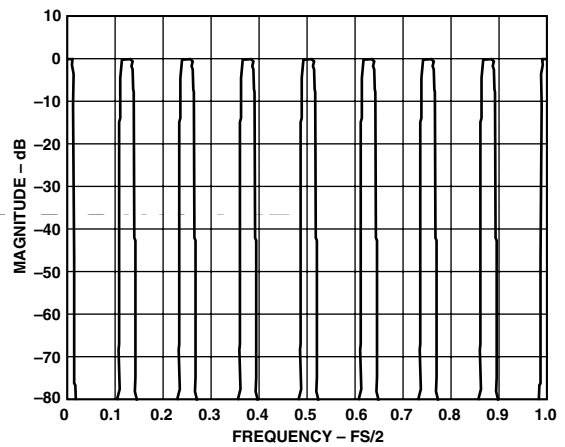

Figure 11b. Input Signal Spectrum ($N = 4$), $\alpha = 0.25$

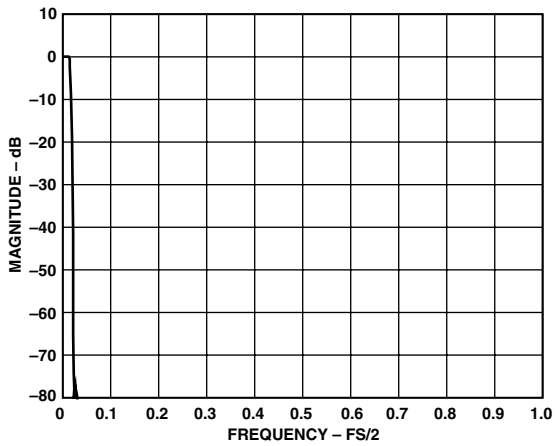

Figure 10c. Response to Input Signal Spectrum ($N = 3$)

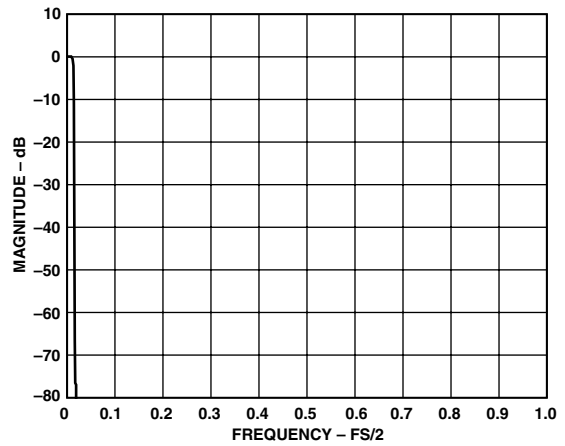

Figure 11c. Response to Input Signal Spectrum ($N = 4$)

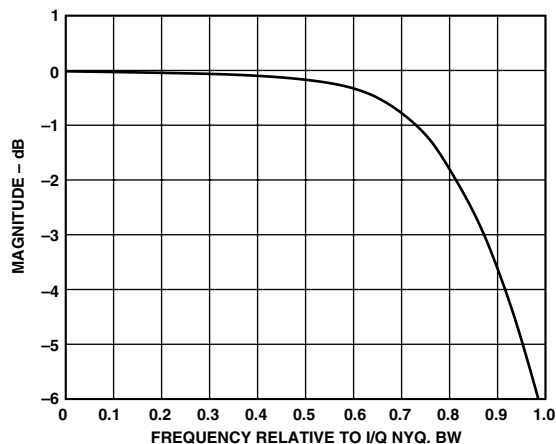

Figure 10d. Cascaded Filter Passband Detail (N = 3)

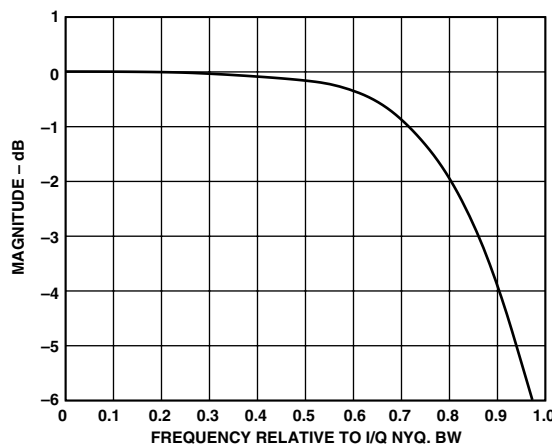

Figure 11d. Cascaded Filter Passband Detail (N = 4)

Inverse SINC Filter (ISF)

The AD9873 transmit section is almost entirely digital. The input “signal” is made up of a time series of digital data words. These data words propagate through the device as numbers. Ultimately, this number stream must be converted to an analog signal. To this end, the AD9873 incorporates an integrated DAC. The output waveform of the DAC is the familiar “staircase” pattern typical of a signal that is sampled and quantized. The staircase pattern is a result of the finite time that the DAC holds a quantized level until the next sampling instant. This is known as a zero-order hold function. The spectrum of the zero-order hold function is the familiar $\text{SIN}(x)/x$, or SINC, envelope.

The series of digital data words presented at the input of the DAC represent an impulse stream. It is the spectrum of this impulse stream, which is the characteristic of the desired output signal. Due to the zero-order hold effect of the DAC, however, the output spectrum is the product of the zero-order hold spectrum (the SINC envelope) and the Fourier transform of the impulse stream. Thus, there is an intrinsic distortion in the output spectrum, which follows the SINC response.

The SINC response is deterministic and totally predictable. Thus, it is possible to predistort the input data stream in a manner, which compensates for the SINC envelope distortion. This can be accomplished by means of an ISF. The ISF incorporated on the AD9873 is a 5-tap, linear phase FIR filter. Its frequency response characteristic is the inverse of the SINC envelope and it equalizes the SINC droop up to 0.6 times the Nyquist frequency. Figure 12a and Figure 12b show the effectiveness of the ISF in correcting for the SINC distortion. Figure 12a includes a graph of the SINC envelope and ISF response while Figure 12b shows the SYSTEM response (which is the product of the SINC and ISF responses). It should be mentioned at this point that the ISF exhibits an insertion loss of 1.4 dB. Thus, signal levels at the output of the AD9873 with the ISF bypassed are 1.4 dB higher than with the ISF engaged. However, for modulated output signals, which have a relatively wide bandwidth, the benefits of the SINC compensation usually outweighed the 1.4 dB loss in output level. The decision of whether or not to use the ISF is an application specific system design issue.

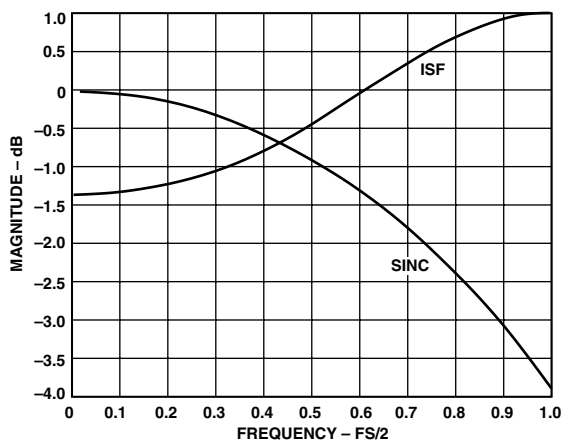

Figure 12a. SINC and ISF Filter Response

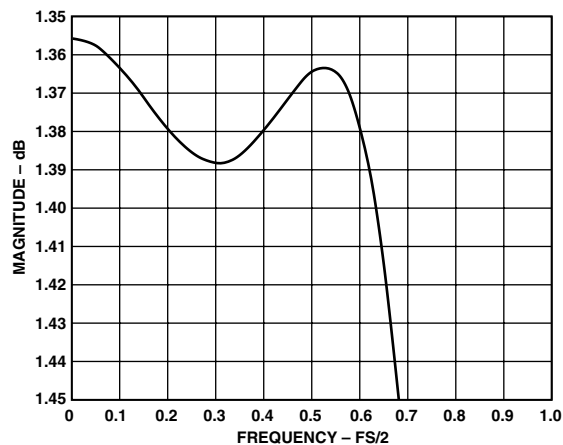

Figure 12b. SINC Compensated Response

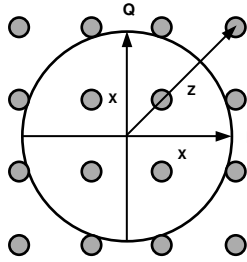

Figure 13. 16-Quadrature Modulation

Tx Signal Level Considerations

The quadrature modulator itself introduces a maximum gain of 3 dB in signal level. To visualize this, assume that both the I data and Q data are fixed at the maximum possible digital value, x. Then the output of the modulator, z, is:

$$z = [x \cos(\omega t) - x \sin(\omega t)]$$

It can be shown that $|z|$ assumes a maximum value of

$$|z| = \sqrt{(x^2 + x^2)} = x\sqrt{2} \text{ (a gain of +3 dB).}$$

However, if the same number of bits were used to represent the $|z|$ values, as is used to represent the x values, an overflow would occur. To prevent this possibility, an effective -3 dB attenuation is internally implemented on the I and Q data path.

$$\left(|z| = \sqrt{(1/2 + 1/2)} = x\right)$$

The following example assumes a Pk/rms level of 10 dB:

$$\begin{aligned} \text{Maximum Symbol Component Input Value} &= \\ &\pm(2047 \text{ LSBs} - 0.2 \text{ dB}) = \pm 2000 \text{ LSBs} \end{aligned}$$

$$\begin{aligned} \text{Maximum Complex Input rms Value} &= \\ 2000 \text{ LSBs} + 6 \text{ dB} - \text{Pk/rms(dB)} &= 1265 \text{ LSBs rms} \end{aligned}$$

Maximum Complex Input rms Value calculation uses both I and Q symbol components which adds a factor of 2 (= 6 dB) to the formula.

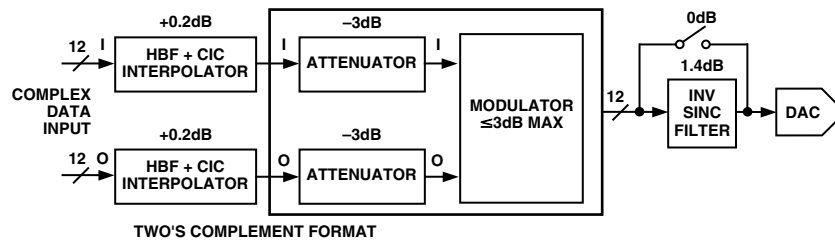

Figure 14. Signal Level Contribution

Table IV. I-Q Input Test Signals

		Input Level	Modulator Output Level
Single-Tone ($f_c - f$)	I = $\cos(f)$ Q = $\cos(f + 90^\circ) = -\sin(f)$	FS - 0.2 dB FS - 0.2 dB	FS - 3.0 dB
Single-Tone ($f_c + f$)	I = $\cos(f)$ Q = $\cos(f + 270^\circ) = \sin(f)$	FS - 0.2 dB FS - 0.2 dB	FS - 3.0 dB
Dual-Tone ($f_c \pm f$)	I = $\cos(f)$ Q = $\cos(f + 180^\circ) = -\cos(f)$ or Q = $\cos(f)$	FS - 0.2 dB FS - 0.2 dB	FS

If INV SINC filter is enabled, an insertion loss of ~1.4 dB (for low frequencies) occurs at the DAC output (see Figure 12a, 12b).

Programming the AD9873 to single-tone transmit mode while disabling the INV SINC filter (address 0Fh) generates a maximum (FS) amplitude single tone with a frequency (f_c) determined by the associated frequency tuning word.

Table IV shows typical I-Q input test signals with amplitude levels related to 12-bit full scale (FS).

Tx Throughput and Latency

Data inputs effect the output fairly quickly but remain effective due to AD9873's filter characteristics. Data transmit latency through the AD9873 is easiest to describe in terms of f_{SYSCLK} clock cycles ($4 f_{\text{MCLK}}$). The numbers quoted are when an effect is first seen after an input value change.

Latency of I/Q data entering the data assembler (AD9873 input) to the DAC output is $119 f_{\text{SYSCLK}}$ clock cycles ($29.75 f_{\text{MCLK}}$ cycles). DC values applied to the data assembler input will take up to $176 f_{\text{SYSCLK}}$ clock cycles ($44 f_{\text{MCLK}}$ cycles) to propagate and settle at the DAC output. Enabling the Inverse SINC Filter adds only $2 f_{\text{SYSCLK}}$ clock cycles latency.

Frequency hopping is accomplished via changing the PROFILE input pins. The time required to switch from one frequency to another is less than $234 f_{\text{SYSCLK}}$ cycles with the Inverse SINC Filter engaged. With the Inverse SINC Filter bypassed, the latency drops to less than $232 f_{\text{SYSCLK}}$ cycles ($58.5 f_{\text{MCLK}}$ cycles).

D/A Converter

A 12-bit digital-to-analog converter (DAC) is used to convert the digitally processed waveform into an analog signal. The worst-case spurious signals due to the DAC are the harmonics of the fundamental signal and their aliases. (Please see the AD9851 data sheet for a detailed explanation of aliased images.) The wideband 12-bit DAC in the AD9873 maintains spurious-free dynamic range (SFDR) performance of 59 dBc up to $f_{\text{OUT}} = 42 \text{ MHz}$ and 54 dBc up to $f_{\text{OUT}} = 65 \text{ MHz}$. The conversion process will produce aliased components of the fundamental signal at $n \times f_{\text{SYSCLK}} \pm f_{\text{CARRIER}}$ ($n = 1, 2, 3$). These are typically filtered with an external RLC filter at the DAC output. It is important for

this analog filter to have a sufficiently flat gain and linear phase response across the bandwidth of interest to avoid modulation impairments. A relatively inexpensive fifth order elliptical low-pass filter is sufficient to suppress the aliased components for HFC network applications.

The AD9873 provides true and complement current outputs. The full-scale output current is set by the RSET resistor at Pin 49. The value of RSET for a particular IOOUT is determined using the following equation:

$$RSET = 32 V_{DACRSET} / I_{OUT} \approx 39.4 / I_{OUT}$$

For example, if a full-scale output current of 20 mA is desired, then $RSET = (39.4/0.02) \Omega$, or approximately 2 k Ω . Every doubling of the RSET value will halve the output current. Maximum output current is specified as 20 mA.

The full-scale output current range of the AD9873 is 2 mA to 20 mA. Full-scale output currents outside of this range will degrade SFDR performance. SFDR is also slightly affected by output matching, that is, the two outputs should be terminated equally for best SFDR performance. The output load should be located as close as possible to the AD9873 package to minimize stray capacitance and inductance. The load may be a simple resistor to ground, an op amp current-to-voltage converter, or a transformer-coupled circuit. It is best not to attempt to directly drive highly reactive loads (such as an LC filter). Driving an LC filter without a transformer requires that the filter be doubly terminated for best performance, that is, the filter input and output should both be resistively terminated with the appropriate values.

The parallel combination of the two terminations will determine the load that the AD9873 will see for signals within the filter pass-band. For example, a 50 Ω terminated input/output low-pass filter will look like a 25 Ω load to the AD9873. The output compliance voltage of the AD9873 is -0.5 V to $+1.5$ V. Any signal developed at the DAC output should not exceed $+1.5$ V, otherwise, signal distortion will result. Furthermore, the signal may extend below ground as much as 0.5 V without damage or signal distortion. The AD9873 true and complement outputs can be differentially combined for common mode rejection using a broadband 1:1 transformer. Using a grounded center-tap results in signals at the AD9873 DAC output pins that are symmetrical about ground. As previously mentioned, by differentially combining the two signals the user can provide some degree of common mode signal rejection. A differential combiner might consist of a transformer or an operational amplifier. The object is to combine or amplify only the difference between two signals and to reject any common, usually undesirable, characteristic, such as 60 Hz hum or “clock feedthrough” that is equally present on both individual signals.

Connecting the AD9873 true and complement outputs to the differential inputs of the gain programmable cable drivers AD8321 or AD8323 provides an optimized solution for the standard compliant cable modem upstream channel. The cable driver’s gain can be programmed through a direct 3-wire interface using the AD9873’s profile registers.

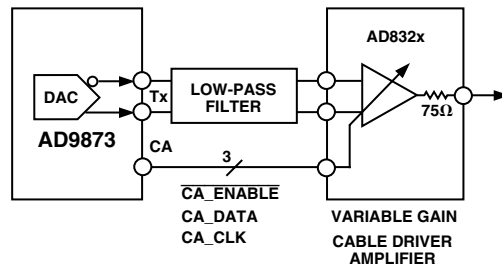

Figure 15. Cable Amplifier Connection

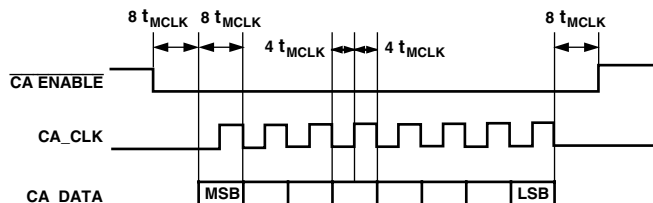

Figure 16. Cable Amplifier Interface Timing

PROGRAMMING/WRITING THE AD8321/AD8323 CABLE DRIVER AMPLIFIER GAIN CONTROL

Programming the gain of the AD832x-family cable driver amplifier can be accomplished via the AD9873 cable amplifier control interface. Four 8-bit registers within the AD9873 (one per profile) store the gain value to be written to the serial 3-wire port. Data transfers to the gain programmable cable driver amplifier are initiated by four conditions. Each is described below:

1. Power-up and Hardware Reset—Upon initial power-up and every hardware reset, the AD9873 clears the contents of the gain control registers to 0, which defines the lowest gain setting of the AD832x. Thus, the AD9873 writes all 0s out of the 3-wire cable amplifier control interface.
2. Software Reset—Writing a one to Bit 5 of address 00h initiates a software reset. On a software reset the AD9873 clears the contents of the gain control registers to 0 for the lowest gain and sets the profile select to 0. The AD9873 writes all 0s out of the 3-wire cable amplifier control interface if the gain was on a different setting (different from 0) before.
3. Change in Profile Selection—The AD9873 samples the PROFILE[0], PROFILE[1] input pins together with the two profile select bits and writes to the AD832x gain control registers when a change in profile and gain is determined. The data written to the cable driver amplifier comes from the AD9873 gain control register associated with the current profile.
4. Write to AD9873 Cable Driver Amplifier Control Registers – The AD9873 will write gain control data associated with the current profile to the AD832x whenever the selected AD9873 cable driver amplifier gain setting is changed.

Once a new stable gain value has been detected (48 to 64 MCLK cycles after initiation) data write starts with $\overline{CA_ENABLE}$ going low. The AD9873 will always finish a write sequence to the cable driver amplifier once it is started. The logic controlling data transfers to the cable driver amplifier uses up to 200 MCLK cycles and has been designed to prevent erroneous write cycles from occurring.

AD9873

RECEIVE PATH (Rx)

ADC Theory of Operation

The AD9873's analog-to-digital converters implement pipelined multistage architectures to achieve high sample rates while consuming low power. Each ADC distributes the conversion over several smaller ADC subblocks, refining the conversion with progressively higher accuracy as it passes the results from stage to stage. As a consequence of the distributed conversion, ADCs require a small fraction of the 2^N comparators used in a traditional n-bit flash-type ADC. A sample-and-hold function within each of the stages permits the first stage to operate on a new input sample while the remaining stages operate on preceding samples. Each stage of the pipeline, excluding the last, consists of a low resolution flash ADC connected to a switched capacitor DAC and interstage residue amplifier (MDAC). The residue amplifier amplifies the difference between the reconstructed DAC output and the flash input for the next stage in the pipeline. One bit of redundancy is used in each one of the stages to facilitate digital correction of flash errors. The last stage simply consists of a flash ADC.

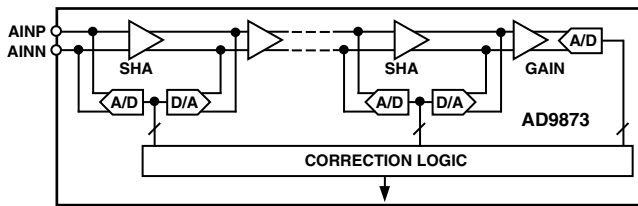

Figure 17. ADC Architecture

The analog inputs of the AD9873 incorporate a novel structure that merges the input sample and hold amplifiers (SHA), and the first pipeline residue amplifiers into single, compact switched-capacitor circuits. This structure achieves considerable noise and power savings over a conventional implementation that uses separate amplifiers by eliminating one amplifier in the pipeline. By matching the sampling network of the input SHA with the first stage flash ADC, the ADCs can sample inputs well beyond the Nyquist frequency with no degradation in performance.

The digital data outputs of the ADCs are represented in straight binary format. They saturate to full scale or zero when the input signal exceeds the input voltage range.

Receive Timing

The AD9873 sends multiplexed data to the Rx IQ and IF outputs on every rising edge of MCLK. Rx SYNC frames the start of each Rx IQ data Symbol. Both 8-bit ADCs transfer their data within four MCLK cycles using 4-bit data packages (I MSB, I LSB, Q MSB and Q LSB). 10-bit and 12-bit ADCs are completely read on every second MCLK cycle. Rx SYNC is high for

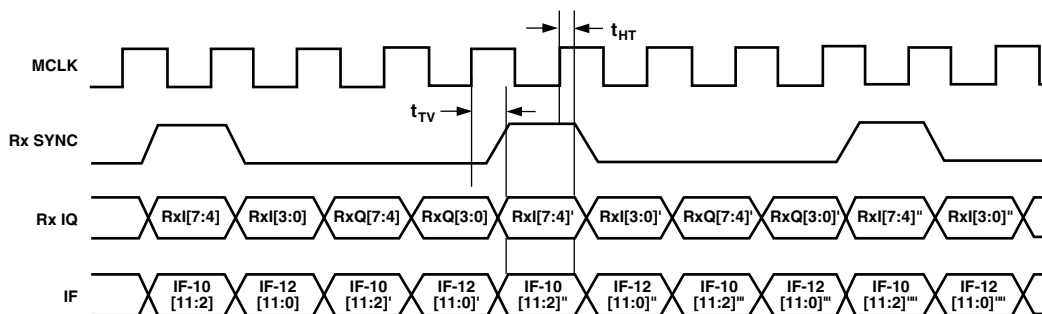

Figure 18. Receive Timing Diagram

every second 10-bit ADC data (if 8-bit ADC is not in power-down mode).

Driving the Analog Inputs

Figure 19 illustrates the equivalent analog inputs of the AD9873, (a switched capacitor input). Bringing CLK to a logic high, opens Switch 3 and closes Switches S1 and S2. The input source is connected to A_{IN} and must charge capacitor C_H during this time. Bringing CLK to a logic low opens S2, and then Switch 1 opens followed by closing S3. This puts the input in the hold mode.

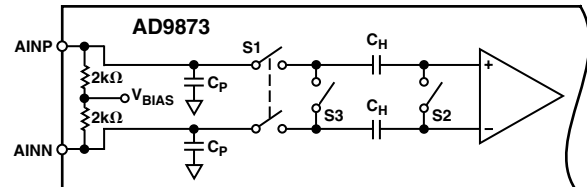

Figure 19. Differential Input Architecture

The structure of the input SHA places certain requirements on the input drive source. The combination of the pin capacitance, and the hold capacitance, C_H , is typically less than 5 pF. The input source must be able to charge or discharge this capacitance to its n-bit accuracy in one-half of a clock cycle. When the SHA goes into track mode, the input source must charge or discharge capacitor C_H from the voltage already stored on C_H to the new voltage. In the worst case, a full-scale voltage step on the input source must provide the charging current through the R_{ON} (100 Ω) of Switch 1 and quickly (within 1/2 CLK period) settle. This situation corresponds to driving a low input impedance. On the other hand, when the source voltage equals the value previously stored on C_H , the hold capacitor requires no input current and the equivalent input impedance is extremely high. Adding series resistance between the output of the signal source and the A_{IN} pin reduces the drive requirements placed on the signal source. Figure 20 shows this configuration.

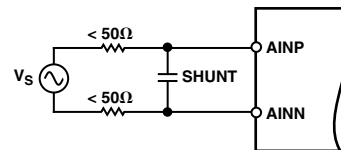

Figure 20. Simple ADC Drive Configuration

The bandwidth of the particular application limits the size of this resistor. To maintain the performance outlined in the data sheet specifications, the resistor should be limited to 50 Ω or less. For applications with signal bandwidths less than 10 MHz, the user may proportionally increase the size of the series resistor. Alternatively, adding a shunt capacitance between the A_{IN} pins can

lower the ac load impedance. The value of this capacitance will depend on the source resistance and the required signal bandwidth. In systems that must use dc coupling, use an op amp to comply with the input requirements of the AD9873.

Op Amp Selection Guide

Op amp selection for the AD9873 is highly application-dependent. In general, the performance requirements of any given application can be characterized by either time domain or frequency domain constraints. In either case, one should carefully select an op amp that preserves the performance of the ADC. This task becomes challenging when one considers the AD9873's high-performance capabilities, coupled with other system-level requirements such as power consumption and cost. The ability to select the optimal op amp may be further complicated either by limited power supply availability and/or limited acceptable supplies for a desired op amp. Newer high-performance op amps typically have input and output range limitations in accordance with their lower supply voltages. As a result, some op amps will be more appropriate in systems where ac-coupling is allowed. When dc-coupling is required, op amps' headroom constraints (such as rail-to-rail op amps) or ones where larger supplies can be used, should be considered. Analog Devices offers differential output operational amplifiers like the AD8131 or AD8132. They can be used for differential or single-ended-to-differential signal conditioning with 8-bit performance to directly drive ADC inputs. The AD8138 is a higher performance version of the AD8132. It provides 12-bit performance and allows different gain settings. Please contact the factory or local sales office for updates on Analog Devices' latest amplifier product offerings.

ADC Differential Inputs

The AD9873 uses 1 V p-p input span for the 8-bit ADC inputs and 2 V p-p for the 10- and 12-bit ADCs. Since not all applications have a signal preconditioned for differential operation, there is often a need to perform a single-ended-to-differential conversion. In systems that do not need a dc input, an RF transformer with a center tap is the best method to generate differential inputs beyond 20 MHz for the AD9873. This provides all the benefits of operating the ADC in the differential mode without contributing additional noise or distortion. An RF transformer also has the added benefit of providing electrical isolation between the signal source and the ADC. An improvement in THD and SFDR performance can be realized by operating the AD9873 in differential mode. The performance enhancement between the differential and single-ended mode is most considerable as the input frequency approaches and goes beyond the Nyquist frequency (i.e., $f_{IN} > FS/2$).

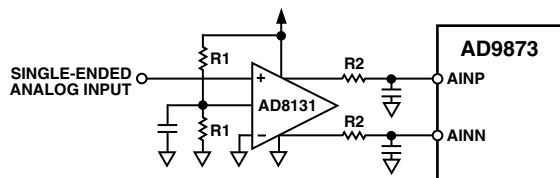

Figure 21. Single-Ended-to-Differential Input Drive

The AD8131 provides a convenient method of converting a single-ended signal to a differential signal. This is an ideal method for generating a direct coupled signal to the AD9873. The AD8131 will accept a signal swinging below 0 V and shift it to an externally provided common-mode voltage. The AD8131 configuration is shown in Figure 21.

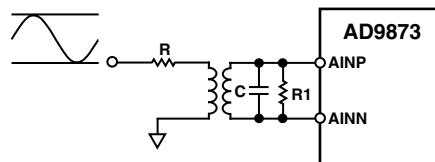

Figure 22. Transformer-Coupled Input

Figure 22 shows the schematic of a suggested transformer circuit. Transformers with turns ratios (n_2/n_1) other than one may be selected to optimize the performance of a given application. For example, selecting a transformer with a higher impedance ratio (e.g., Mini-Circuits T16-6T with an impedance ratio of $(z_2/z_1) = 16 = (n_2/n_1)^2$) effectively "steps up" the signal amplitude, thus further reducing the driving requirements of the signal source. In Figure 22, a resistor, R1, is added between the analog inputs to match the source impedance R as in the formula $R1 \parallel 4 \text{ k}\Omega = (z_2/z_1) R$.

ADC Voltage References

The AD9873 has three independent internal references for its 8-bit, 10-bit, and 12-bit ADCs. Both 8-bit ADCs have a 1 V p-p input and share one internal reference source. The 10-bit and 12-bit ADCs, however, are designed for 2 V p-p input voltages with each of them having their own internal reference. Figure 15 shows the proper connections of the reference pins REFT and REFB.

External references may be necessary for systems that require high accuracy gain matching between ADCs or improvements in temperature drift and noise characteristics. External references REFT and REFB need to be centered at $AVDD/2$ with offset voltages as specified:

$$\begin{aligned} \text{REFT-8: } & AVDD/2 + 0.25 \text{ V} & \text{REFB-8: } & AVDD/2 - 0.25 \text{ V} \\ \text{REFT-10, -12: } & AVDD/2 + 0.5 \text{ V} & \text{REFB-10, -12: } & AVDD/2 - 0.5 \text{ V} \end{aligned}$$

A differential level of 0.5 V between the reference pins results in a 1 V p-p ADC input level A_{IN} . A differential level of 1 V between the reference pins results in a 2 V p-p ADC input level A_{IN} . Internal reference sources can be powered down when external references are used (Register Address 02h).

Video Input

For sampling video-type waveforms, such as NTSC and PAL signals, the Video Input channel provides black level clamping. Figure 23 shows the circuit configuration for using the video channel input (Pin 100). An external blocking capacitor is used with the on-chip video clamp circuit, to level-shift the input signal to a desired reference level. The clamp circuit automatically senses the most negative portion of the input signal, and adjusts the voltage across the input capacitor. This forces the black level of the input signal to be equal to the value programmed into the clamp level register (register address 07h).

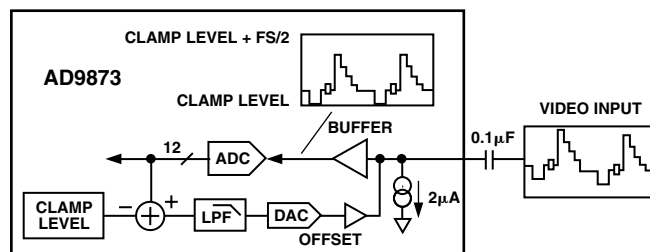

Figure 23. Video Clamp Circuit Input

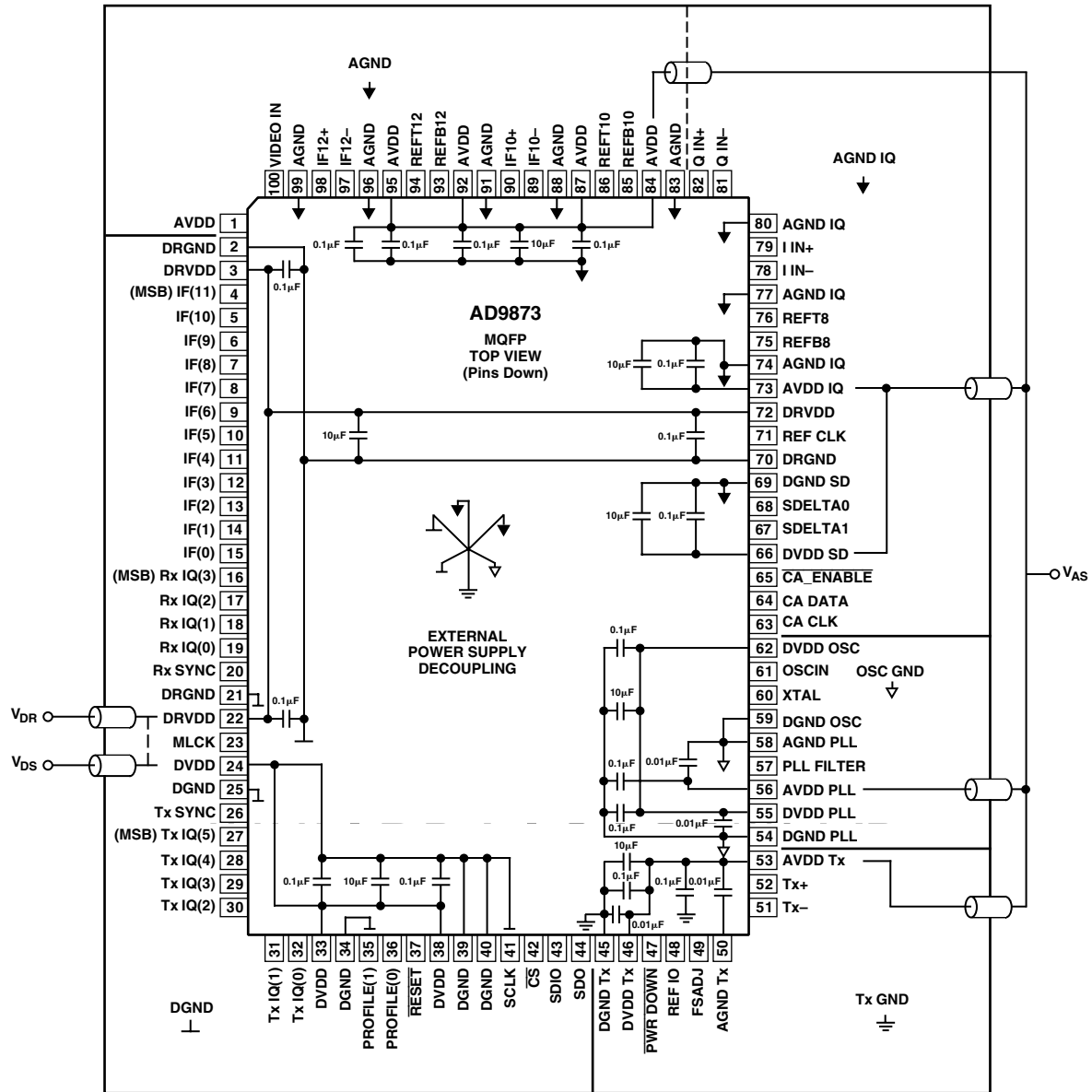

Figure 24. Power Supply Decoupling

POWER AND GROUNDING CONSIDERATIONS

In systems seeking to simultaneously achieve high speed and high performance, the implementation and construction of the printed circuit board design is often as important as the circuit design. Proper RF techniques must be used in device selection, placement, routing, supply bypassing, and grounding. Figure 24 illustrates proper power supply decoupling. Split-ground technique can be used to isolate digital and high-speed clock generation noise from the analog front ends. The analog front end may be further split to minimize crosstalk between the transmit and receive sections. Noise-sensitive video-IF signals can also be separated from the more robust IQ-ADC signal path. One common ground underneath the chip connects all ground splits and assures short distances for ground pin connections. Figure 24

uses two separate power supplies. V_{AS} powers the analog and clock generation section of the chip while V_{DS} is used for the digital signals of the chip. An extra power supply V_{DR} is only needed in applications that require lower level digital outputs. $DRVDD$ and $DVDD$ pins should be connected together for normal mode. V_{DS} (and V_{DR}) should not be directly connected to the power supply of noisy digital signal processing chips. It might even be considered as an analog supply. Ferrite beads and $10\ \mu F$ decoupling capacitors isolate power supplies between functional blocks. Each supply pin is further decoupled with a $0.1\ \mu F$ multi-layer ceramic capacitor that is mounted as close as possible to the pin. In the high-speed PLL and DAC sections additional $0.01\ \mu F$ capacitors may be required as shown in Figure 24.

EVALUATION BOARD

Hardware

The AD9873-EB is an evaluation board for the AD9873 analog front end converter. Careful attention to layout and circuit design allow the user to easily and effectively evaluate the AD9873 in any application where high-resolution, and high-speed conversion is required. This board allows the user flexibility to operate the AD9873 in various configurations. Several jumper or solder bridge settings are available. The ADC inputs can be differentially driven by transformers or by an AD8138 when using connector J8 as the only input. Differential to single-ended transmit output options include direct transformer coupled or filtered (75 MHz) and variable gain amplified by the AD8323. Digital transmit (Tx) inputs are designed to be driven from various word generators and allow for proper load termination.

Software

The AD9873-EB software provides a graphical user interface that allows easy programming and read back of AD9873 register settings. Three programming windows are available. The Direct register access window allows AD9873 register write and read-back in decimal, binary or hexadecimal data format. The register map window provides a very easy, function orientated programming of AD9873 bits and registers. Programming hints appear when the cursor is moved over an input field. Registers are updated on every WRITE button click. The advanced register access window allows programming of register access sequences.

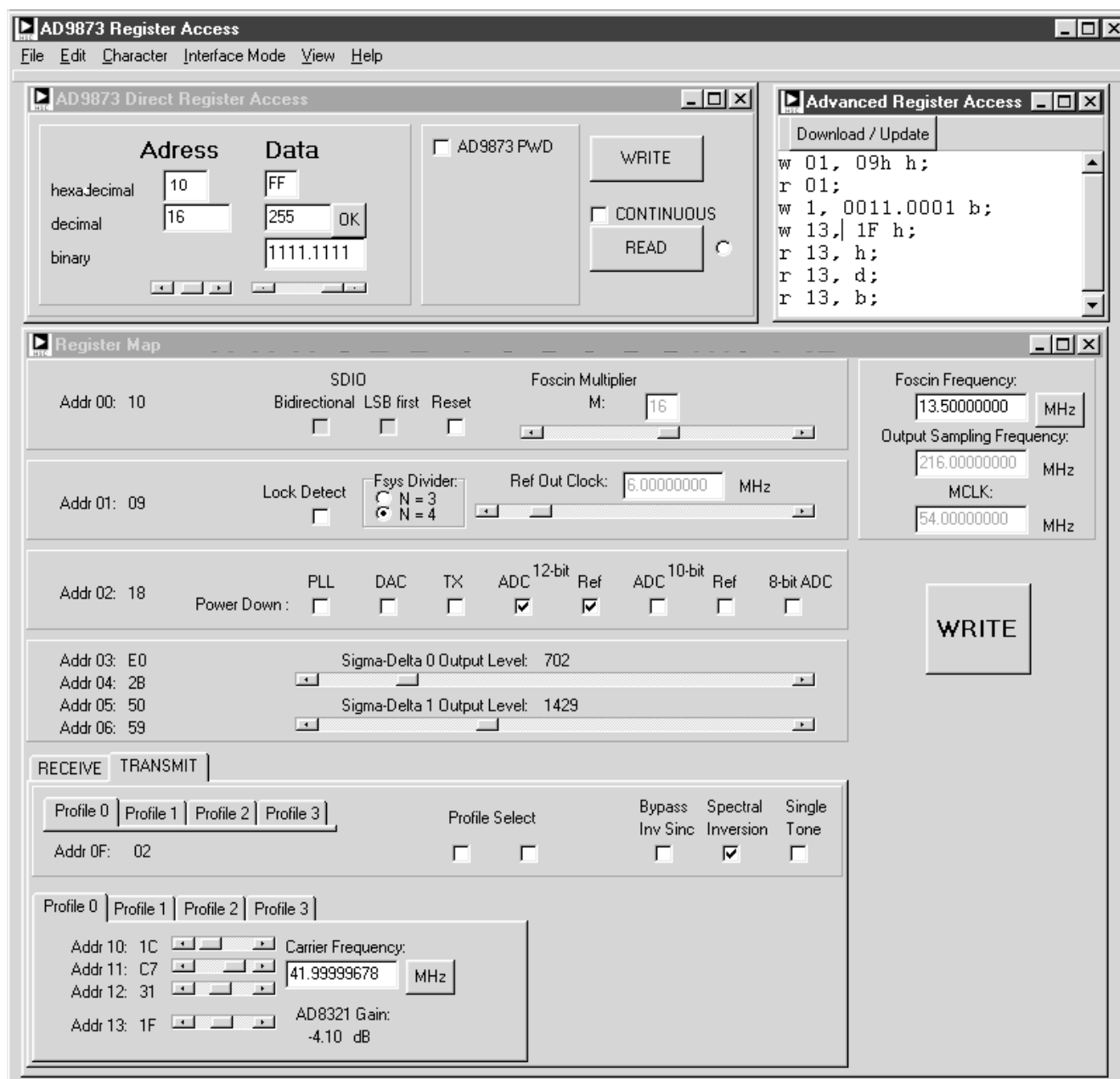

Figure 25. Evaluation Board Software

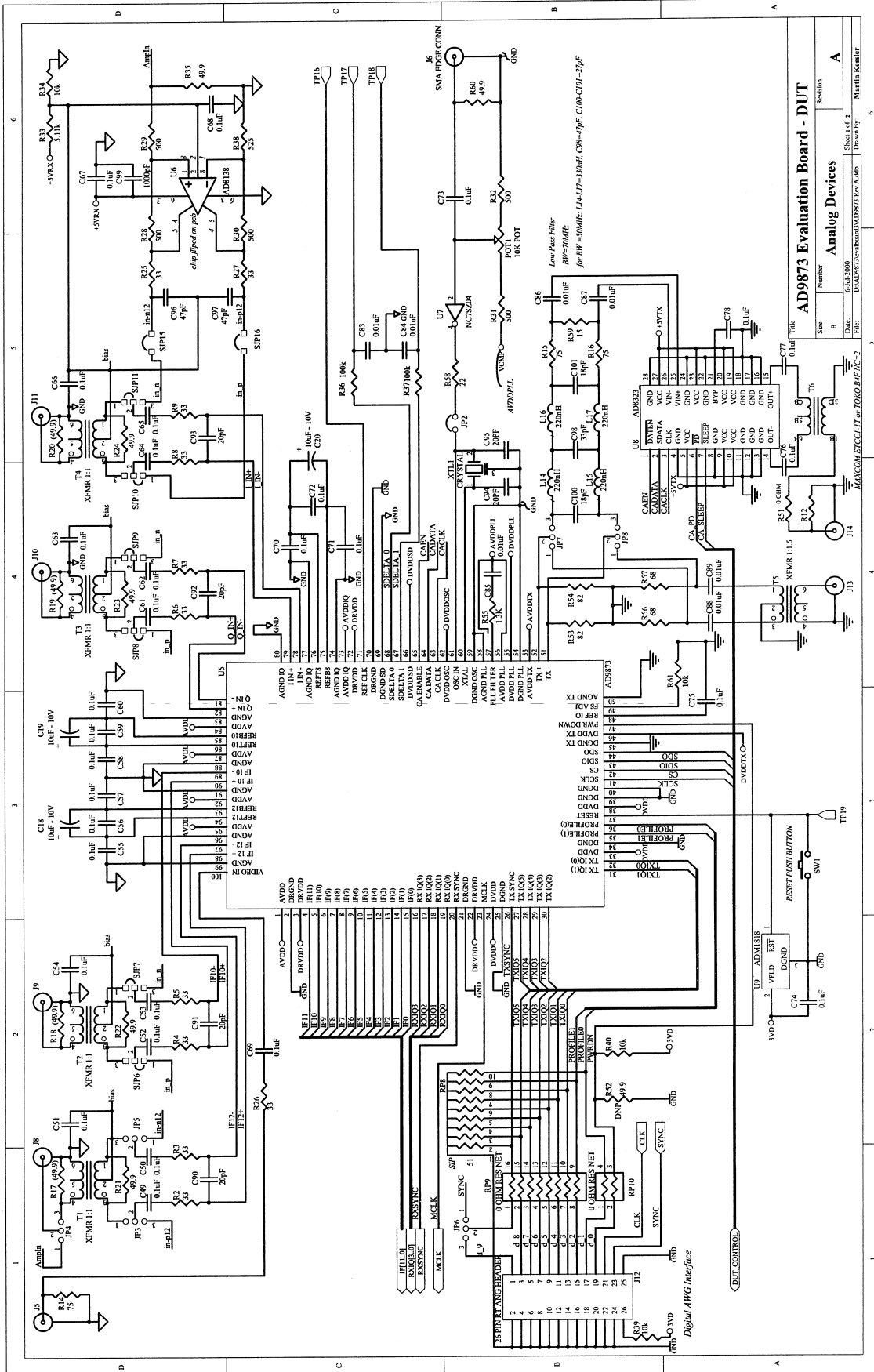
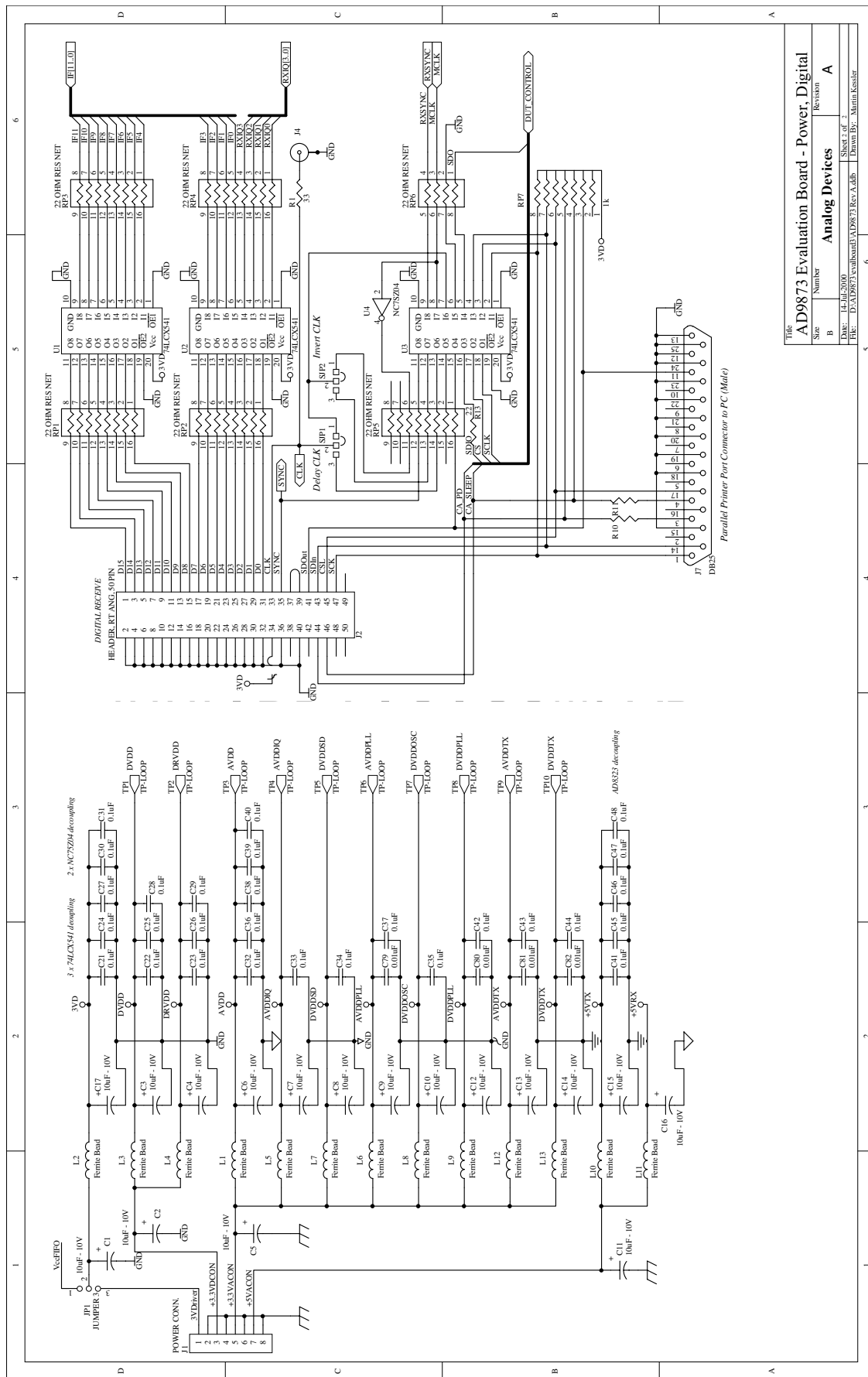

Figure 26. Evaluation Board Schematic First Page, AD9873 and Analog Circuitry



Title		AD9873 Evaluation Board - Power, Digital	
Size	Number	Revision	A
B			
Date: 14-Jul-2009		Sheet 5 of 6	
File: D:\AD9873\evalboard\AD9873 Rev A.dwg		Drawn By: Maria Kessler	

Figure 27. Evaluation Board Schematic Second Page, Power and Digital Circuitry

AD9873

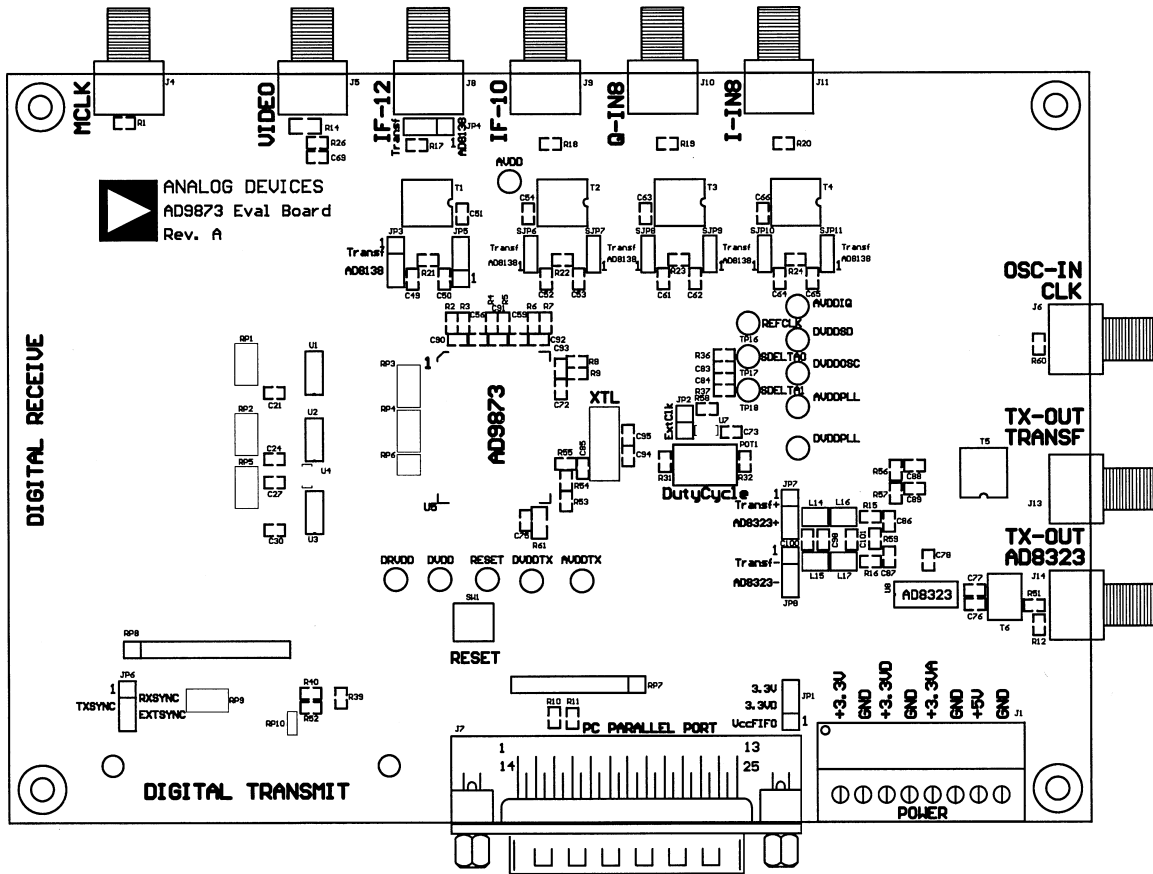

--- Figure 28. Evaluation Board PCB, Assembly Top Side ---

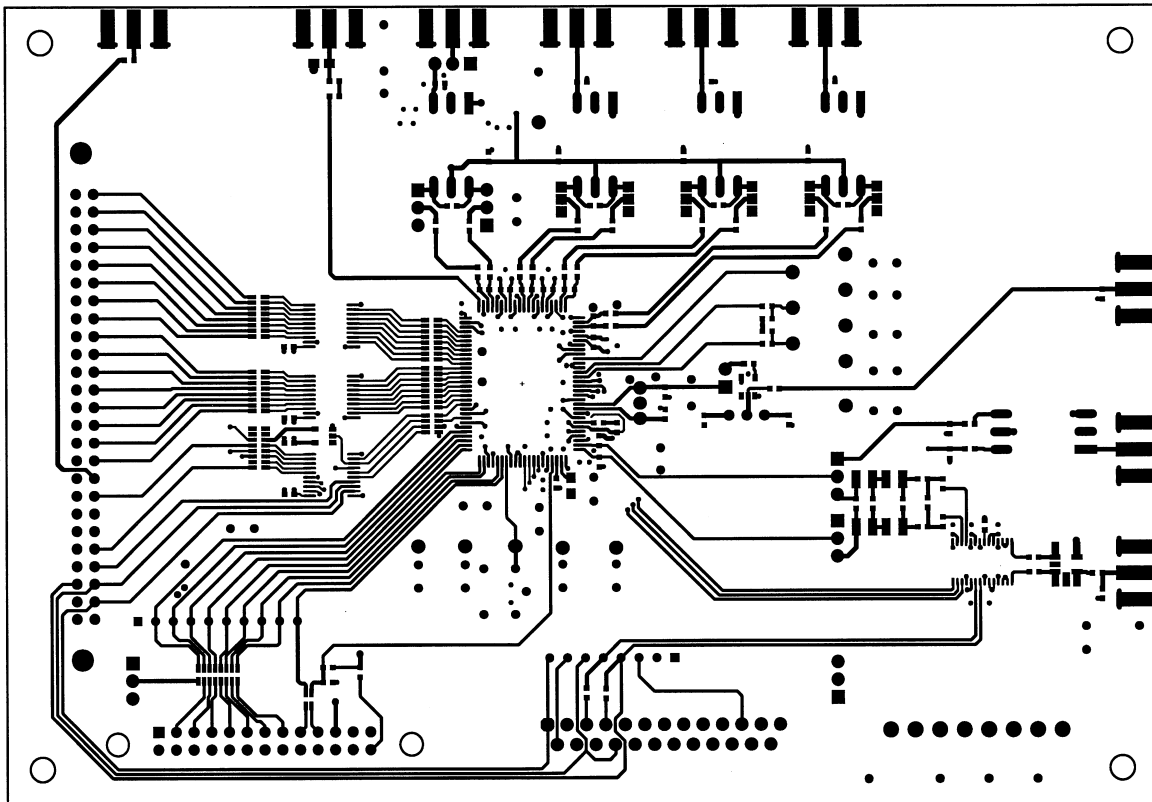

Figure 29. Evaluation Board PCB, Top Layer

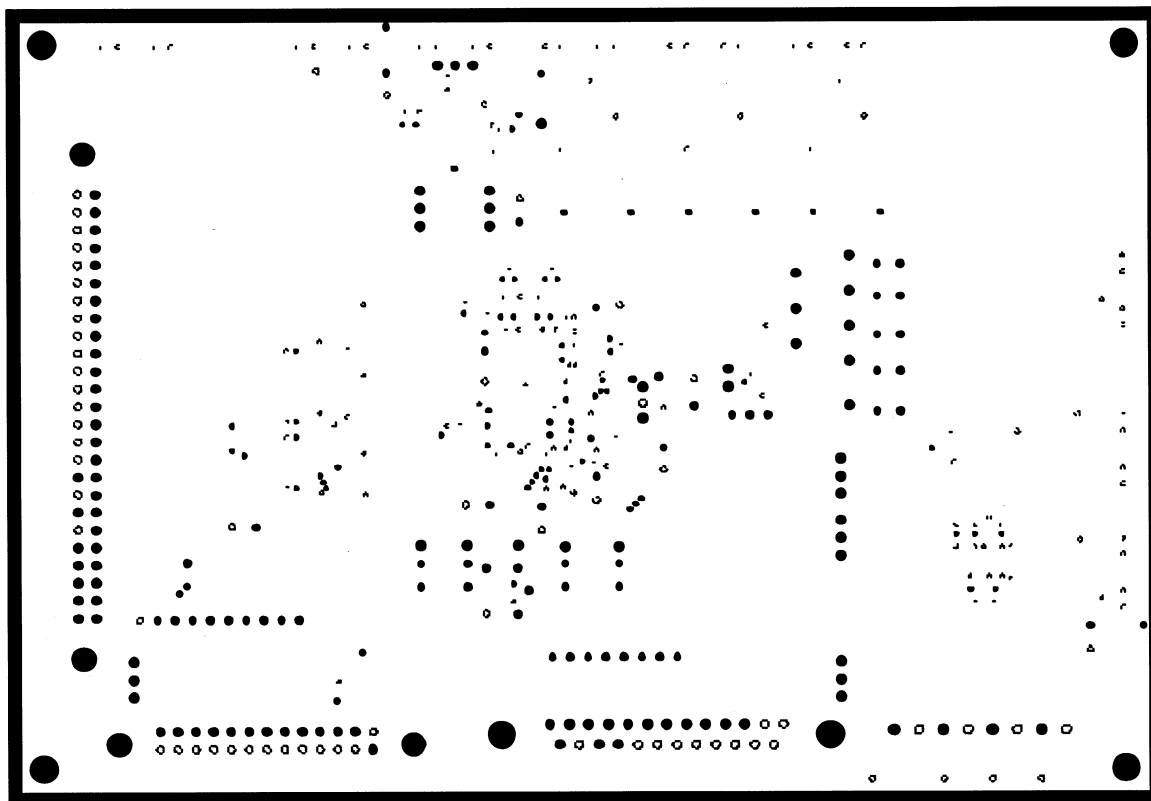

Figure 30 Evaluation Board PCB, Ground Plane

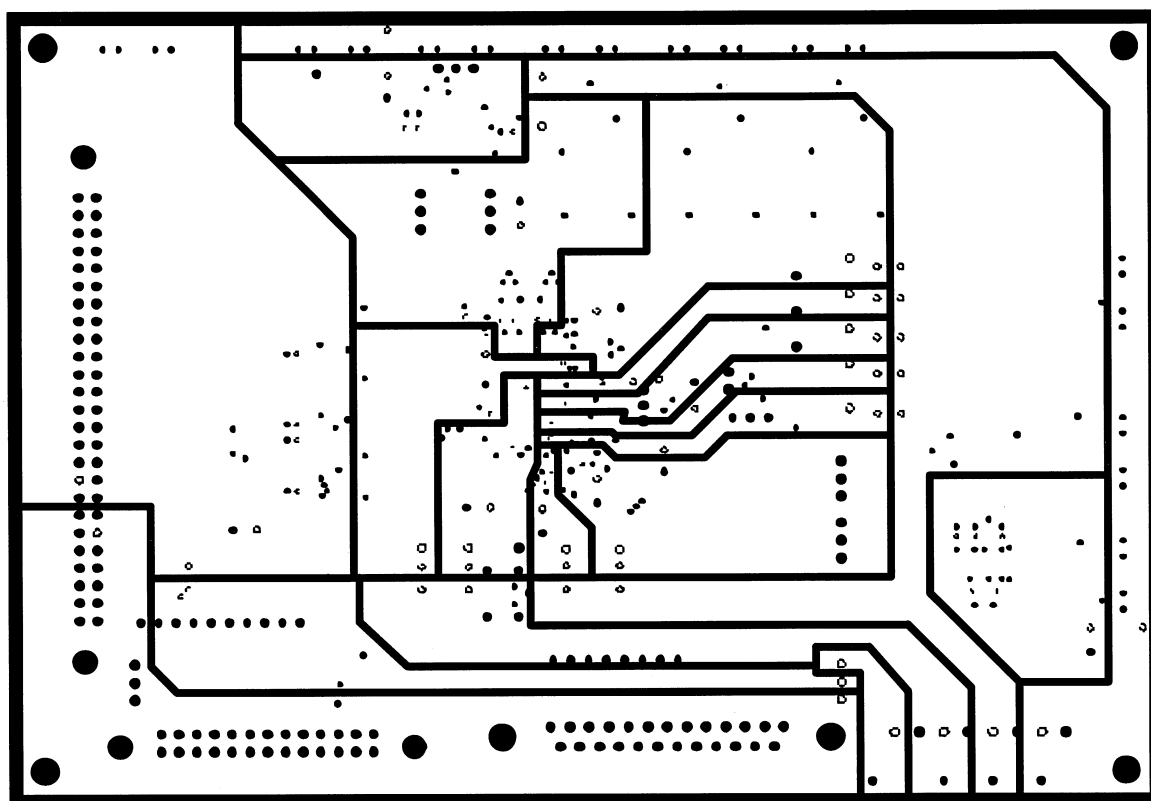

Figure 31. Evaluation Board PCB, Power Plane

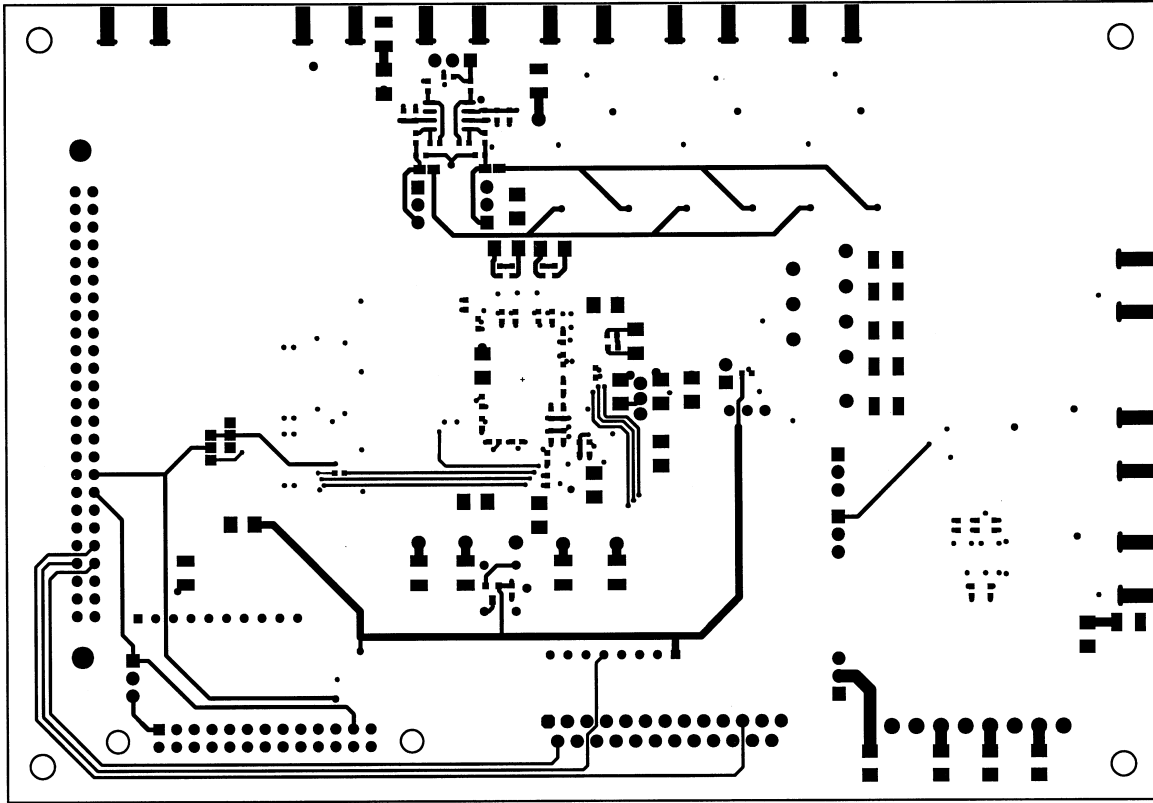

Figure 32. Evaluation Board PCB, Bottom Layer

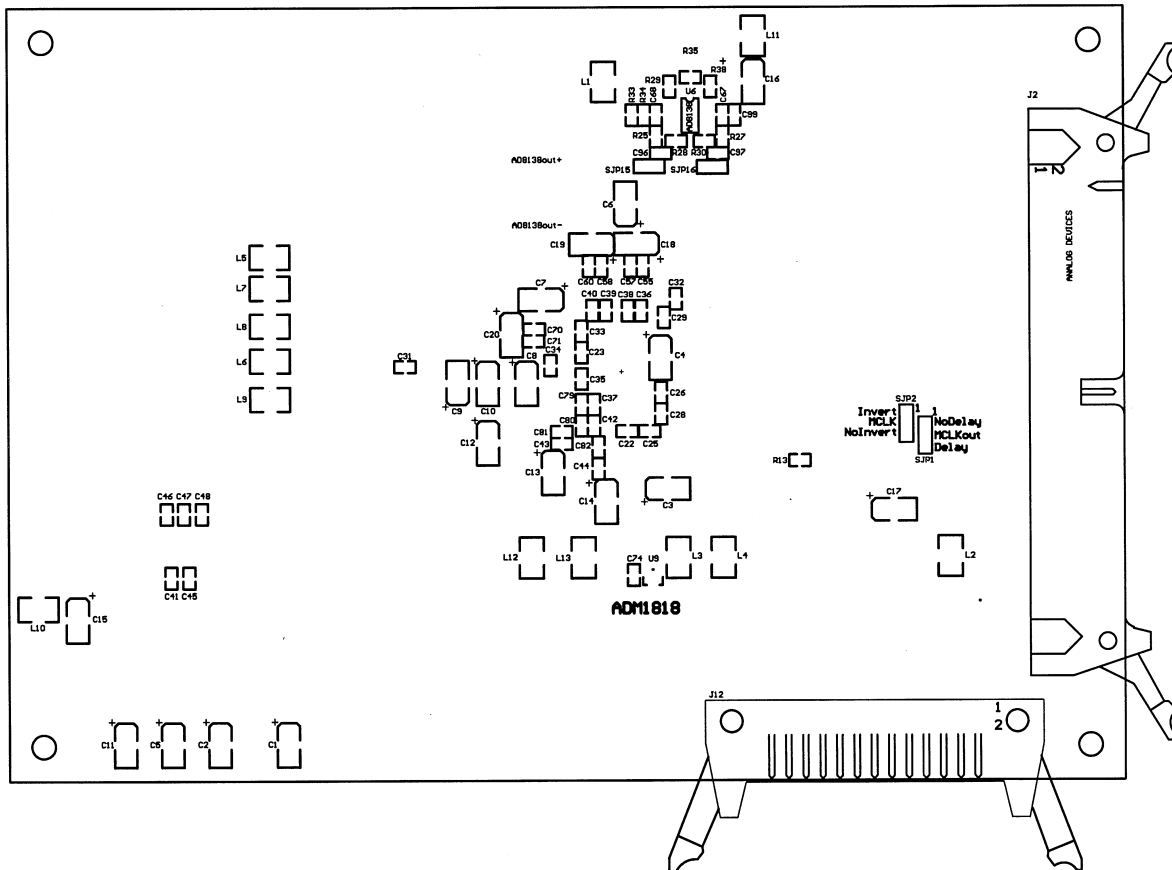
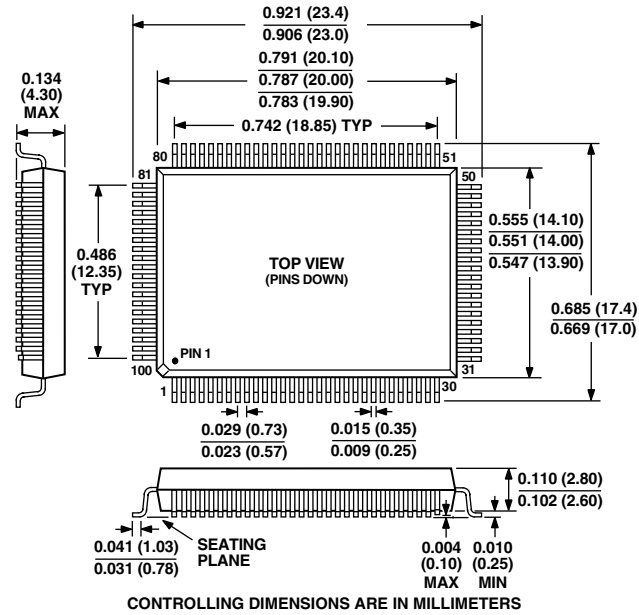

Figure 33. Evaluation Board PCB, Assembly Bottom Side

OUTLINE DIMENSIONS

Dimensions shown in inches and (mm).

**100-Lead Metric Quad Flatpack (MQFP)
(S-100C)**



C01584-4.5-7/00 (rev. 0)

PRINTED IN U.S.A.