

FEATURES

10-lead MSOP
400 μ A supply current
 -40°C to $+125^{\circ}\text{C}$ temperature range
On-board precision resistors
Reference

ADR821: 2.8 V to 15 V operation
ADR827: 2.7 V to 15 V operation
 $\pm 0.2\%$ initial accuracy
15 ppm/ $^{\circ}\text{C}$ temperature drift maximum
 $+5\text{ mA}/-3\text{ mA}$ output drive

Amplifier

ADR821
 $\pm 2.8\text{ V}$ to $\pm 15\text{ V}$ operation
2.8 V to 15 V single-supply operation
ADR827
 $\pm 2.7\text{ V}$ to $\pm 15\text{ V}$ operation
2.7 V to 15 V single-supply operation
Rail-to-rail input and output
500 μ V offset voltage maximum
50 nA bias current maximum
Unity gain stable
No phase reversal

APPLICATIONS

Battery-powered instrumentation
Portable medical instrumentation
Data acquisition systems
Industrial process controls
Automotive applications

GENERAL DESCRIPTION

The ADR821/ADR827 combines a precision voltage reference and an op amp in a 10-lead mini small outline package (MSOP). The reference and the op amp can be operated independently, offering the user a range of flexibility when arranging the combination. Featuring a combined operating current of less than 400 μ A and 15 ppm/ $^{\circ}\text{C}$ temperature drift on the reference, the ADR821/ADR827 are ideally suited for applications requiring precision and low power.

FUNCTIONAL BLOCK DIAGRAM

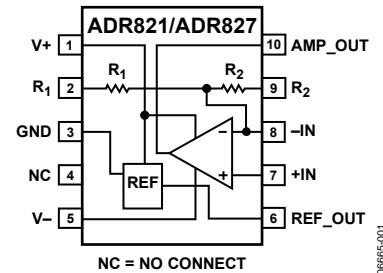

Figure 1.

Table 1. Selection Table

Part No.	Reference V_{OUT}	Reference Accuracy	Reference Temperature Coefficient
ADR827ARMZ	1.25 V	$\pm 0.4\%$	30 ppm/ $^{\circ}\text{C}$
ADR827BRMZ	1.25 V	$\pm 0.2\%$	15 ppm/ $^{\circ}\text{C}$
ADR821ARMZ	2.50 V	$\pm 0.4\%$	30 ppm/ $^{\circ}\text{C}$
ADR821BRMZ	2.50 V	$\pm 0.2\%$	15 ppm/ $^{\circ}\text{C}$

Available with the reference at 1.25 V and at 2.5 V, the ADR821/ADR827 also come in two grades. The reference on the A grade offers 30 ppm/ $^{\circ}\text{C}$ temperature drift performance and $\pm 0.4\%$ initial accuracy. The B grade provides a tighter temperature drift performance of 15 ppm/ $^{\circ}\text{C}$ and only $\pm 0.2\%$ initial accuracy. All versions operate from -40°C to $+125^{\circ}\text{C}$.

Rev. 0

Information furnished by Analog Devices is believed to be accurate and reliable. However, no responsibility is assumed by Analog Devices for its use, nor for any infringements of patents or other rights of third parties that may result from its use. Specifications subject to change without notice. No license is granted by implication or otherwise under any patent or patent rights of Analog Devices. Trademarks and registered trademarks are the property of their respective owners.

TABLE OF CONTENTS

Features	1	Absolute Maximum Ratings	9
Applications.....	1	Thermal Resistance	9
Functional Block Diagram	1	ESD Caution.....	9
General Description	1	Pin Configuration and Function Descriptions.....	10
Revision History	2	Typical Performance Characteristics	11
Specifications.....	3	Reference	11
ADR821 Electrical Characteristics—Reference	3	Amplifier (AD821/AD827).....	15
ADR821 Electrical Characteristics—Amplifier ($V_s = \pm 2.8\text{ V}$)	4	Applications Information	18
ADR821 Electrical Characteristics—Amplifier ($V_s = \pm 15\text{ V}$).....	5	+2.5 V and -2.5 V Outputs (ADR821)	18
ADR827 Electrical Characteristics—Reference	6	2.5 V and 5.0 V Outputs (ADR821).....	18
ADR827 Electrical Characteristics—Amplifier ($V_s = \pm 2.7\text{ V}$)	7	Multiple 2.5 V Outputs (ADR821).....	18
ADR827 Electrical Characteristics—Amplifier ($V_s = \pm 15\text{ V}$).....	8	Outline Dimensions	19
		Ordering Guide	19

REVISION HISTORY

10/07—Revision 0: Initial Version

SPECIFICATIONS

ADR821 ELECTRICAL CHARACTERISTICS—REFERENCE

$V_{IN} = 2.8\text{ V to }15\text{ V}$, $T_A = 25^\circ\text{C}$, $C_{IN} = C_{OUT} = 0.1\ \mu\text{F}$, unless otherwise noted.

Table 2.

Parameter	Symbol	Conditions	Min	Typ	Max	Unit
OUTPUT VOLTAGE	V_{OUT}					
A Grade			2.490	2.500	2.510	V
B Grade			2.495	2.500	2.505	V
INITIAL ACCURACY	V_{OERR}					
A Grade					10	mV
					0.40	%
B Grade					5.00	mV
					0.20	%
TEMPERATURE COEFFICIENT	TCV_{OUT}	$-40^\circ\text{C} < T_A < +125^\circ\text{C}$				
A Grade					30	ppm/ $^\circ\text{C}$
B Grade					15	ppm/ $^\circ\text{C}$
DROPOUT ($V_{OUT} - V_{IN}$)	V_{DO}	$I_{OUT} = 0\text{ mA}$			0.3	V
LINE REGULATION	$\Delta V_{OUT}/\Delta V_{IN}$	$V_{IN} = 2.8\text{ V to }15\text{ V}$, $-40^\circ\text{C} < T_A < +125^\circ\text{C}$		20	50	ppm/V
LOAD REGULATION	$\Delta V_{OUT}/\Delta I_{LOAD}$	$I_{LOAD} = 0\text{ mA to }5\text{ mA}$, $-40^\circ\text{C} < T_A < +125^\circ\text{C}$, $V_{IN} = 5\text{ V}$			400	ppm/mA
		$I_{LOAD} = 0\text{ mA to }5\text{ mA}$, $V_{IN} = 5\text{ V}$		80	200	ppm/mA
		$I_{LOAD} = -3\text{ mA to }0\text{ mA}$, $-40^\circ\text{C} < T_A < +125^\circ\text{C}$, $V_{IN} = 5\text{ V}$			600	ppm/mA
		$I_{LOAD} = -3\text{ mA to }+5\text{ mA}$, $V_{IN} = 5\text{ V}$		80	300	ppm/mA
VOLTAGE NOISE	$e_{N\text{ p-p}}$	0.1 Hz to 10 Hz		16		$\mu\text{V p-p}$
BROADBAND NOISE		10 Hz to 10 kHz		430		$\mu\text{V p-p}$
TURN-ON SETTLING TIME	t_R	$C_{IN} = 0\ \mu\text{F}$		80		μs
POWER SUPPLY						
Positive Supply Current	I_{SY+}	No load, $-40^\circ\text{C} < T_A < +125^\circ\text{C}$			400	μA
Negative Supply Current	I_{SY-}	No load, $-40^\circ\text{C} < T_A < +125^\circ\text{C}$			300	μA
ON-BOARD RESISTORS	R_1, R_2					
Resistor Tolerance			8	10	12	k Ω
Resistor Matching				0.5		%
Resistor Temperature Coefficient	TC			± 100		ppm/ $^\circ\text{C}$

ADR821/ADR827

ADR821 ELECTRICAL CHARACTERISTICS—AMPLIFIER ($V_S = \pm 2.8\text{ V}$)

$V_{CM} = 0\text{ V}$, $T_A = 25^\circ\text{C}$, unless otherwise noted.

Table 3.

Parameter	Symbol	Conditions	Min	Typ	Max	Unit
INPUT CHARACTERISTICS						
Input Offset Voltage	V_{OS}	$-40^\circ\text{C} < T_A < +125^\circ\text{C}$		100	500	μV
Input Offset Voltage Drift	TCV_{OS}	$-40^\circ\text{C} < T_A < +125^\circ\text{C}$		2	5	$\mu\text{V}/^\circ\text{C}$
Input Bias Current	I_B	$-40^\circ\text{C} < T_A < +125^\circ\text{C}$		15	50	nA
Input Offset Bias Current	I_{OS}	$-40^\circ\text{C} < T_A < +125^\circ\text{C}$		5	25	nA
Large Signal Voltage Gain	A_{VO}	$V_{OUT} = -1.5\text{ V to } +1.5\text{ V}$ $R_{LOAD} = 10\text{ k}\Omega$, $-40^\circ\text{C} < T_A < +125^\circ\text{C}$	99	108		dB
Common-Mode Rejection Ratio	CMRR	$R_{LOAD} = 2\text{ k}\Omega$, $-40^\circ\text{C} < T_A < +125^\circ\text{C}$	94	100		dB
		$V_{CM} = -1.5\text{ V to } +1.5\text{ V}$, $-40^\circ\text{C} < T_A < +125^\circ\text{C}$	75	100		dB
			85			dB
OUTPUT CHARACTERISTICS						
Output Voltage High	V_{OH}	$I_{LOAD} = 1\text{ mA}$ $I_{LOAD} = 1\text{ mA}$, $-40^\circ\text{C} < T_A < +125^\circ\text{C}$	2.6 2.55	2.7		V V
Output Voltage Low	V_{OL}	$I_{LOAD} = 1\text{ mA}$		-2.7	-2.6	V
		$I_{LOAD} = 1\text{ mA}$, $-40^\circ\text{C} < T_A < +125^\circ\text{C}$			-2.55	V
POWER SUPPLY						
Positive Supply Current	I_{SY+}	No load, $-40^\circ\text{C} < T_A < +125^\circ\text{C}$			400	μA
Negative Supply Current	I_{SY-}	No load, $-40^\circ\text{C} < T_A < +125^\circ\text{C}$			300	μA
Power Supply Rejection Ratio	PSRR	$V_S = \pm 2.8\text{ V to } \pm 15\text{ V}$	75	100		dB
DYNAMIC PERFORMANCE						
Slew Rate	SR	$R_{LOAD} = 10\text{ k}\Omega$, $C_{LOAD} = 10\text{ pF}$, $A_V = +1$		0.5		V/ μs
Gain Bandwidth Product	GBP	$C_{LOAD} = 14\text{ pF}$		1.0		MHz
Phase Margin	ϕ_M	$C_{LOAD} = 14\text{ pF}$		72.5		Degrees
NOISE PERFORMANCE						
Voltage Noise	$e_{N\text{ p-p}}$	$f = 0.1\text{ Hz to } 10\text{ Hz}$		0.2		$\mu\text{V p-p}$
Voltage Noise Density	e_N	$f = 1\text{ kHz}$		16		nV/ $\sqrt{\text{Hz}}$

ADR821 ELECTRICAL CHARACTERISTICS—AMPLIFIER ($V_S = \pm 15\text{ V}$)

$V_{CM} = 0\text{ V}$, $T_A = 25^\circ\text{C}$, unless otherwise noted.

Table 4.A

Parameter	Symbol	Conditions	Min	Typ	Max	Unit
INPUT CHARACTERISTICS						
Input Offset Voltage	V_{OS}	$-40^\circ\text{C} < T_A < +125^\circ\text{C}$		100	500	μV
Input Offset Voltage Drift	TCV_{OS}	$-40^\circ\text{C} < T_A < +125^\circ\text{C}$		2	5	$\mu\text{V}/^\circ\text{C}$
Input Bias Current	I_B	$-40^\circ\text{C} < T_A < +125^\circ\text{C}$		10	50	nA
Input Offset Bias Current	I_{OS}	$-40^\circ\text{C} < T_A < +125^\circ\text{C}$		5	25	nA
Large Signal Voltage Gain	A_{VO}	$V_{OUT} = -14\text{ V to } +14\text{ V}$ $R_{LOAD} = 10\text{ k}\Omega$, $-40^\circ\text{C} < T_A < +125^\circ\text{C}$	109.5	118		dB
Common-Mode Rejection Ratio	CMRR	$R_{LOAD} = 2\text{ k}\Omega$, $-40^\circ\text{C} < T_A < +125^\circ\text{C}$	100	111		dB
		$V_{CM} = -14\text{ V to } +14\text{ V}$, $-40^\circ\text{C} < T_A < +125^\circ\text{C}$	75	100		dB
			85			dB
OUTPUT CHARACTERISTICS						
Output Voltage high	V_{OH}	$I_{LOAD} = 1\text{ mA}$ $I_{LOAD} = 1\text{ mA}$, $-40^\circ\text{C} < T_A < +125^\circ\text{C}$	14.8	14.9		V
Output Voltage Low	V_{OL}	$I_{LOAD} = 1\text{ mA}$ $I_{LOAD} = 1\text{ mA}$, $-40^\circ\text{C} < T_A < +125^\circ\text{C}$		-14.9	-14.8	V
Output Current	I_{SC}	Short-circuit current		± 20	-14.75	mA
POWER SUPPLY						
Positive Supply Current	I_{SY+}	No load, $-40^\circ\text{C} < T_A < +125^\circ\text{C}$			400	μA
Negative Supply Current	I_{SY-}	No load, $-40^\circ\text{C} < T_A < +125^\circ\text{C}$			300	μA
Power Supply Rejection Ratio	PSRR	$V_S = \pm 2.8\text{ V to } \pm 15\text{ V}$	75	100		dB
DYNAMIC PERFORMANCE						
Slew Rate	SR	$R_{LOAD} = 10\text{ k}\Omega$, $C_{LOAD} = 10\text{ pF}$, $A_V = +1$		0.5		V/ μs
Gain Bandwidth Product	GBP	$C_{LOAD} = 14\text{ pF}$		1.0		MHz
Phase Margin	ϕ_M	$C_{LOAD} = 14\text{ pF}$		75.4		Degrees
NOISE PERFORMANCE						
Voltage Noise	$e_{N\text{ p-p}}$	$f = 0.1\text{ Hz to } 10\text{ Hz}$		0.2		$\mu\text{V p-p}$
Voltage Noise Density	e_N	$f = 1\text{ kHz}$		16		nV/ $\sqrt{\text{Hz}}$

ADR821/ADR827

ADR827 ELECTRICAL CHARACTERISTICS—REFERENCE

$V_{IN} = 2.7\text{ V to }15\text{ V}$, $T_A = 25^\circ\text{C}$, $C_{IN} = C_{OUT} = 0.1\ \mu\text{F}$, unless otherwise noted.

Table 5.

Parameter	Symbol	Conditions	Min	Typ	Max	Unit
OUTPUT VOLTAGE	V_{OUT}					
A Grade			1.245	1.250	1.255	V
B Grade			1.2475	1.250	1.2525	V
INITIAL ACCURACY	V_{OERR}					
A Grade					5	mV
					0.40	%
B Grade					2.50	mV
					0.20	%
TEMPERATURE COEFFICIENT	TCV_{OUT}	$-40^\circ\text{C} < T_A < +125^\circ\text{C}$				
A Grade					30	ppm/ $^\circ\text{C}$
B Grade					15	ppm/ $^\circ\text{C}$
DROPOUT ($V_{OUT} - V_{IN}$)	V_{DO}	$I_{OUT} = 0\text{ mA}$			1.45	V
LINE REGULATION	$\Delta V_{OUT}/\Delta V_{IN}$	$V_{IN} = 2.7\text{ V to }15\text{ V}$, $-40^\circ\text{C} < T_A < +125^\circ\text{C}$		20	50	ppm/V
LOAD REGULATION	$\Delta V_{OUT}/\Delta I_{LOAD}$	$I_{LOAD} = 0\text{ mA to }5\text{ mA}$, $-40^\circ\text{C} < T_A < +125^\circ\text{C}$, $V_{IN} = 3\text{ V}$			400	ppm/mA
		$I_{LOAD} = 0\text{ mA to }5\text{ mA}$, $V_{IN} = 3\text{ V}$		80	200	ppm/mA
		$I_{LOAD} = -3\text{ mA to }0\text{ mA}$, $-40^\circ\text{C} < T_A < +125^\circ\text{C}$, $V_{IN} = 3\text{ V}$			600	ppm/mA
		$I_{LOAD} = -3\text{ mA to }+5\text{ mA}$, $V_{IN} = 3\text{ V}$		80	300	ppm/mA
VOLTAGE NOISE	$e_{N\text{ p-p}}$	0.1 Hz to 10 Hz		8		$\mu\text{V p-p}$
BROADBAND NOISE		10 Hz to 10 kHz		260		$\mu\text{V p-p}$
TURN-ON SETTLING TIME	t_R	$C_{IN} = 0\ \mu\text{F}$, $C_{OUT} = 0.1\ \mu\text{F}$		80		μs
POWER SUPPLY						
Positive Supply Current	I_{SY+}	No load, $-40^\circ\text{C} < T_A < +125^\circ\text{C}$			400	μA
Negative Supply Current	I_{SY-}	No load, $-40^\circ\text{C} < T_A < +125^\circ\text{C}$			300	μA
ON-BOARD RESISTORS	R_1, R_2					
Resistor Tolerance			8	10	12	k Ω
Resistor Matching				0.5		%
Resistor Temperature Coefficient	TC			± 100		ppm/ $^\circ\text{C}$

ADR827 ELECTRICAL CHARACTERISTICS—AMPLIFIER ($V_S = \pm 2.7\text{ V}$)

$V_{CM} = 0\text{ V}$, $T_A = 25^\circ\text{C}$, unless otherwise noted.

Table 6.

Parameter	Symbol	Conditions	Min	Typ	Max	Unit
INPUT CHARACTERISTICS						
Input Offset Voltage	V_{OS}	$-40^\circ\text{C} < T_A < +125^\circ\text{C}$		100	500	μV
Input Offset Voltage Drift	TCV_{OS}	$-40^\circ\text{C} < T_A < +125^\circ\text{C}$		2	5	$\mu\text{V}/^\circ\text{C}$
Input Bias Current	I_B	$-40^\circ\text{C} < T_A < +125^\circ\text{C}$		15	50	nA
Input Offset Bias Current	I_{OS}	$-40^\circ\text{C} < T_A < +125^\circ\text{C}$		5	25	nA
Large Signal Voltage Gain	A_{VO}	$V_{OUT} = -1.5\text{ V to }+1.5\text{ V}$				
		$R_{LOAD} = 10\text{ k}\Omega$, $-40^\circ\text{C} < T_A < +125^\circ\text{C}$	99	108		dB
		$R_{LOAD} = 2\text{ k}\Omega$, $-40^\circ\text{C} < T_A < +125^\circ\text{C}$	94	100		dB
Common-Mode Rejection Ratio	CMRR	$V_{CM} = -1.5\text{ V to }+1.5\text{ V}$, $-40^\circ\text{C} < T_A < +125^\circ\text{C}$	75	100		dB
			85			dB
OUTPUT CHARACTERISTICS						
Output Voltage High	V_{OH}	$I_{LOAD} = 1\text{ mA}$	2.5	2.6		V
		$I_{LOAD} = 1\text{ mA}$, $-40^\circ\text{C} < T_A < +125^\circ\text{C}$	2.45			V
Output Voltage Low	V_{OL}	$I_{LOAD} = 1\text{ mA}$		-2.6	-2.5	V
		$I_{LOAD} = 1\text{ mA}$, $-40^\circ\text{C} < T_A < +125^\circ\text{C}$			-2.45	V
POWER SUPPLY						
Positive Supply Current	I_{SY+}	No load, $-40^\circ\text{C} < T_A < +125^\circ\text{C}$			400	μA
Negative Supply Current	I_{SY-}	No load, $-40^\circ\text{C} < T_A < +125^\circ\text{C}$			300	μA
Power Supply Rejection Ratio	PSRR	$V_S = \pm 2.7\text{ V to } \pm 15\text{ V}$	75	100		dB
DYNAMIC PERFORMANCE						
Slew Rate	SR	$R_{LOAD} = 10\text{ k}\Omega$, $C_{LOAD} = 10\text{ pF}$, $A_V = +1$		0.5		$\text{V}/\mu\text{s}$
Gain Bandwidth Product	GBP	$C_{LOAD} = 14\text{ pF}$		1.0		MHz
Phase Margin	ϕ_M	$C_{LOAD} = 14\text{ pF}$		71.3		Degrees
NOISE PERFORMANCE						
Voltage Noise	$e_{N\text{ p-p}}$	$f = 0.1\text{ Hz to }10\text{ Hz}$		0.2		$\mu\text{V p-p}$
Voltage Noise Density	e_N	$f = 1\text{ kHz}$		16		$\text{nV}/\sqrt{\text{Hz}}$

ADR821/ADR827

ADR827 ELECTRICAL CHARACTERISTICS—AMPLIFIER ($V_S = \pm 15\text{ V}$)

$V_{CM} = 0\text{ V}$, $T_A = 25^\circ\text{C}$, unless otherwise noted.

Table 7.

Parameter	Symbol	Conditions	Min	Typ	Max	Unit
INPUT CHARACTERISTICS						
Input Offset Voltage	V_{OS}	$-40^\circ\text{C} < T_A < +125^\circ\text{C}$		100	500	μV
Input Offset Voltage Drift	TCV_{OS}	$-40^\circ\text{C} < T_A < +125^\circ\text{C}$		2	5	$\mu\text{V}/^\circ\text{C}$
Input Bias Current	I_B	$-40^\circ\text{C} < T_A < +125^\circ\text{C}$		10	50	nA
Input Offset Bias Current	I_{OS}	$-40^\circ\text{C} < T_A < +125^\circ\text{C}$		5	25	nA
Large Signal Voltage Gain	A_{VO}	$V_{OUT} = -14\text{ V to } +14\text{ V}$				
		$R_{LOAD} = 10\text{ k}\Omega$, $-40^\circ\text{C} < T_A < +125^\circ\text{C}$	109.5	118		dB
		$R_{LOAD} = 2\text{ k}\Omega$, $-40^\circ\text{C} < T_A < +125^\circ\text{C}$	100	111		dB
Common-Mode Rejection Ratio	CMRR	$V_{CM} = -14\text{ V to } +14\text{ V}$, $-40^\circ\text{C} < T_A < 125^\circ\text{C}$	75	100		dB
			85			dB
OUTPUT CHARACTERISTICS						
Output Voltage High	V_{OH}	$I_{LOAD} = 1\text{ mA}$	14.8	14.9		V
		$I_{LOAD} = 1\text{ mA}$, $-40^\circ\text{C} < T_A < +125^\circ\text{C}$	14.75			V
Output Voltage Low	V_{OL}	$I_{LOAD} = 1\text{ mA}$		-14.9	-14.8	V
		$I_{LOAD} = 1\text{ mA}$, $-40^\circ\text{C} < T_A < +125^\circ\text{C}$			-14.75	V
Output Current	I_{SC}	Short-circuit current		± 20		mA
POWER SUPPLY						
Positive Supply Current	I_{SY+}	No load, $-40^\circ\text{C} < T_A < +125^\circ\text{C}$			400	μA
Negative Supply Current	I_{SY-}	No load, $-40^\circ\text{C} < T_A < +125^\circ\text{C}$			300	μA
Power Supply Rejection Ratio	PSRR	$V_S = \pm 2.7\text{ V to } \pm 15\text{ V}$	75	100		dB
DYNAMIC PERFORMANCE						
Slew Rate	SR	$R_{LOAD} = 10\text{ k}\Omega$, $C_{LOAD} = 10\text{ pF}$, $A_V = +1$		0.5		V/ μs
Gain Bandwidth Product	GBP	$C_{LOAD} = 14\text{ pF}$		1.0		MHz
Phase Margin	ϕ_M	$C_{LOAD} = 14\text{ pF}$		75.4		Degrees
NOISE PERFORMANCE						
Voltage Noise	$e_{N\text{ p-p}}$	$f = 0.1\text{ Hz to } 10\text{ Hz}$		0.2		$\mu\text{V p-p}$
Voltage Noise Density	e_N	$f = 1\text{ kHz}$		16		nV/ $\sqrt{\text{Hz}}$

ABSOLUTE MAXIMUM RATINGS

T_A= 25°C, unless otherwise noted.

Table 8.

Parameter	Rating
Supply Voltage	±18 V
Output Short-Circuit Duration to GND	Indefinite
Storage Temperature Range	-65°C to +125°C
Operating Temperature Range	-40°C to +125°C
Junction Temperature Range	-65°C to +125°C
Lead Temperature (Soldering, 60 sec)	300°C

Stresses above those listed under Absolute Maximum Ratings may cause permanent damage to the device. This is a stress rating only; functional operation of the device at these or any other conditions above those indicated in the operational section of this specification is not implied. Exposure to absolute maximum rating conditions for extended periods may affect device reliability.

THERMAL RESISTANCE

θ_{JA} is specified for the worst-case conditions, that is, θ_{JA} is specified for device soldered in circuit board for surface-mount packages.

Table 9. Thermal Resistance

Package Type	θ _{JA}	θ _{JC}	Unit
10-Lead MSOP (RM-10)	172	50	°C/W

ESD CAUTION



ESD (electrostatic discharge) sensitive device. Charged devices and circuit boards can discharge without detection. Although this product features patented or proprietary protection circuitry, damage may occur on devices subjected to high energy ESD. Therefore, proper ESD precautions should be taken to avoid performance degradation or loss of functionality.

ADR821/ADR827

PIN CONFIGURATION AND FUNCTION DESCRIPTIONS

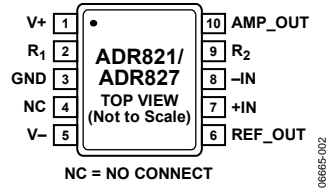

Figure 2. Pin Configuration

Table 10. Pin Function Descriptions

Pin No.	Mnemonic	Description
1	V+	Input Voltage of the Reference/Positive Supply of the Amplifier
2	R ₁	Resistance Tied to Positive Input of the Amplifier
3	GND	Ground
4	NC	Do Not Connect Any External Components to This Pin
5	V-	Negative Supply of the Amplifier
6	REF_OUT	Output Voltage of the Reference
7	+IN	Positive Input of the Amplifier
8	-IN	Negative Input of the Amplifier
9	R ₂	Resistance Tied to Positive Input of the Amplifier
10	AMP_OUT	Output Pin of the Amplifier

TYPICAL PERFORMANCE CHARACTERISTICS

REFERENCE

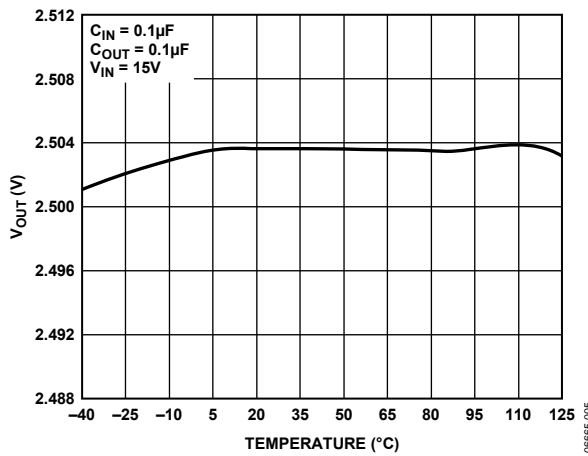

Figure 3. ADR821 V_{OUT} vs. Temperature

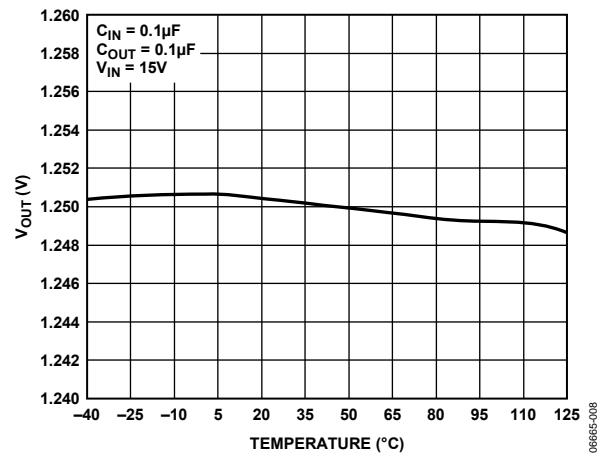

Figure 6. ADR827 V_{OUT} vs. Temperature

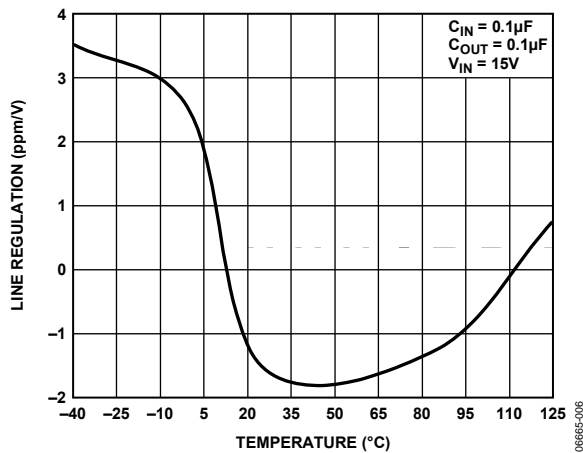

Figure 4. ADR821 Line Regulation vs. Temperature

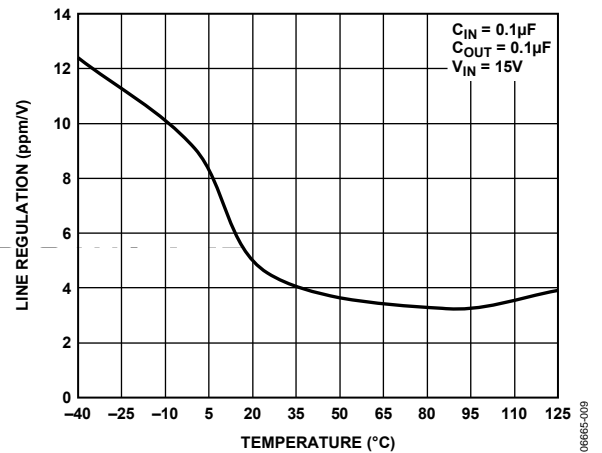

Figure 7. ADR827 Line Regulation vs. Temperature

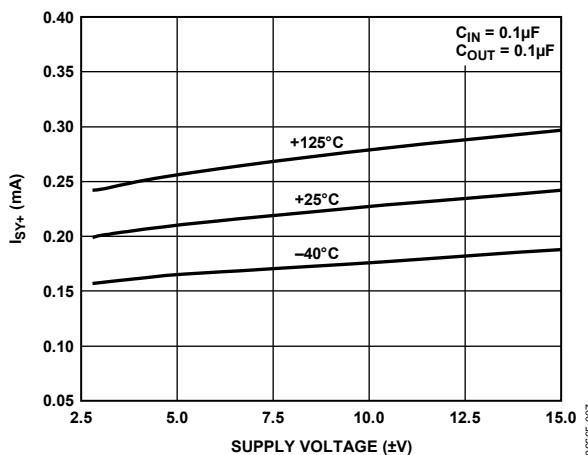

Figure 5. ADR821 Supply Current (+) vs. Supply Voltage

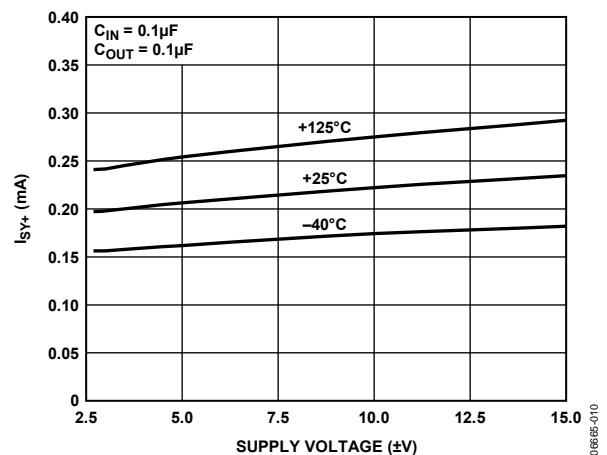

Figure 8. ADR827 Supply Current (+) vs. Supply Voltage

ADR821/ADR827

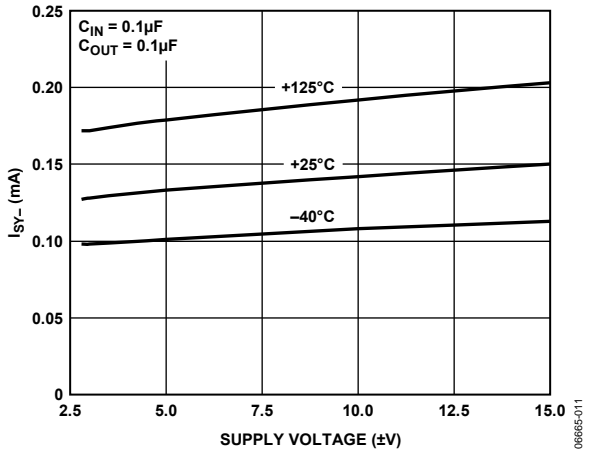

Figure 9. ADR821 Supply Current (-) vs. Supply Voltage

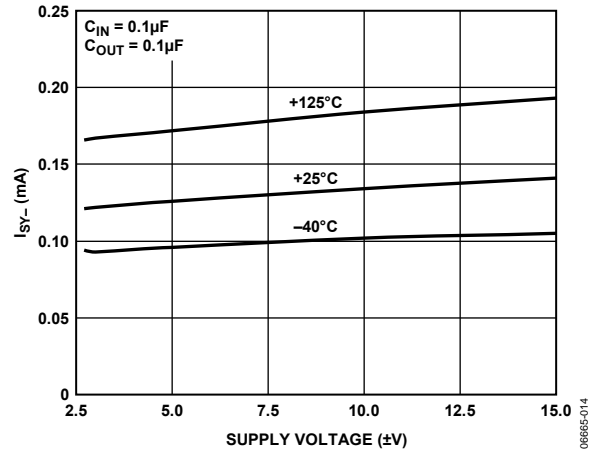

Figure 12. ADR827 Supply Current (-) vs. Supply Voltage

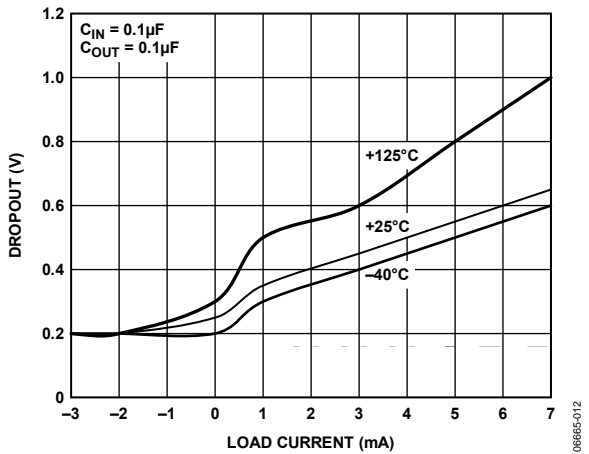

Figure 10. ADR821 Dropout vs. Load Current

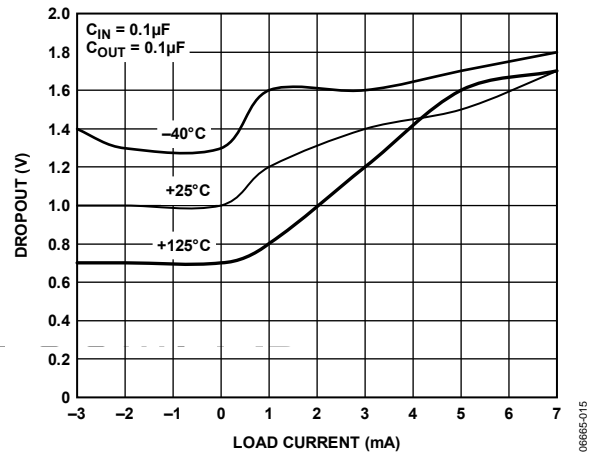

Figure 13. ADR827 Dropout vs. Load Current

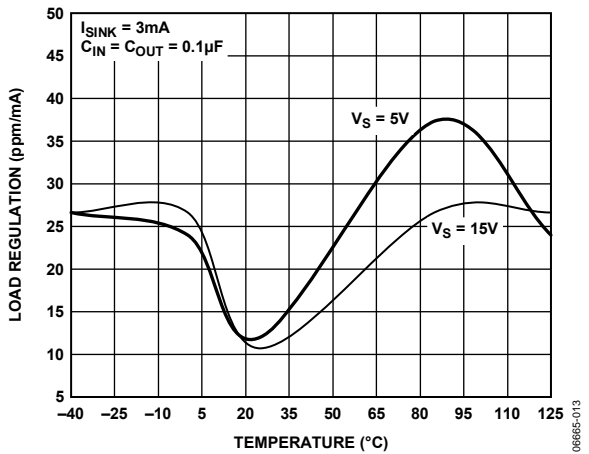

Figure 11. ADR821 Load Regulation vs. Temperature

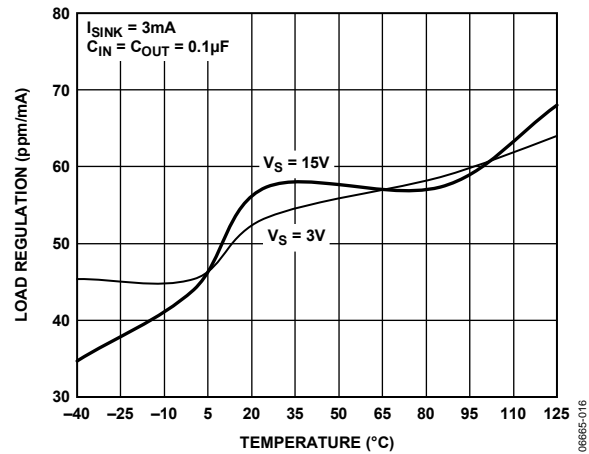

Figure 14. ADR827 Load Regulation vs. Temperature

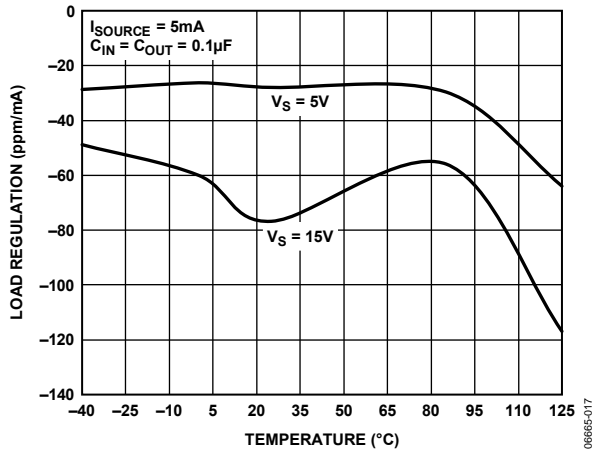

Figure 15. ADR821 Load Regulation vs. Temperature

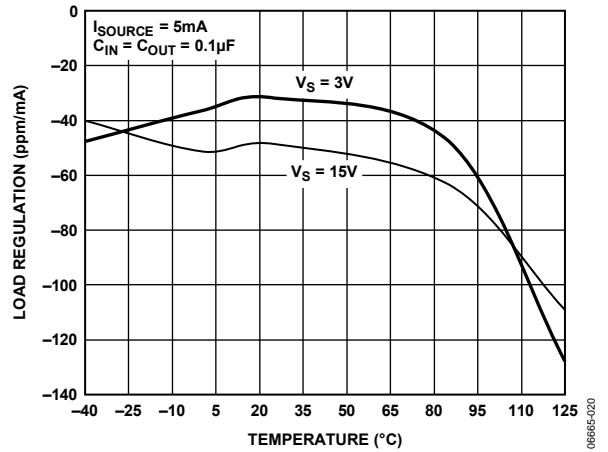

Figure 18. ADR827 Load Regulation vs. Temperature

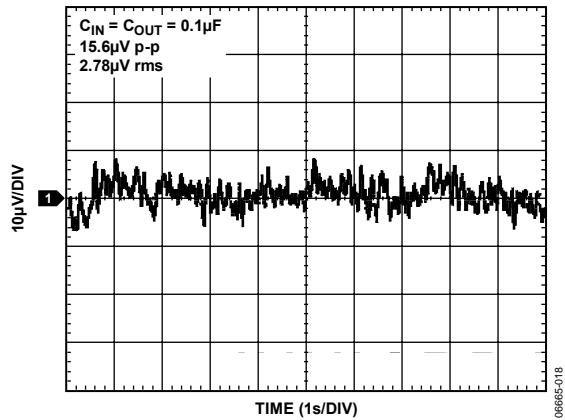

Figure 16. ADR821 0.1 Hz to 10 Hz Noise

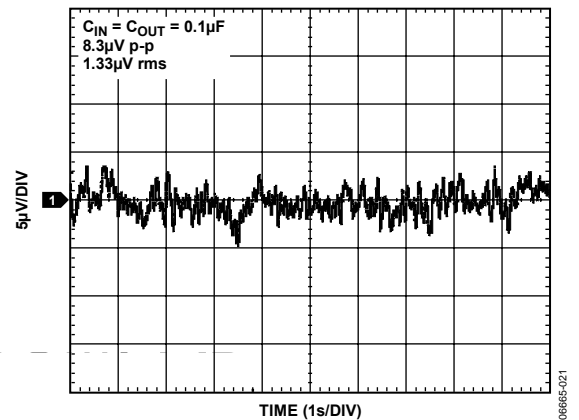

Figure 19. ADR827 0.1 Hz to 10 Hz Noise

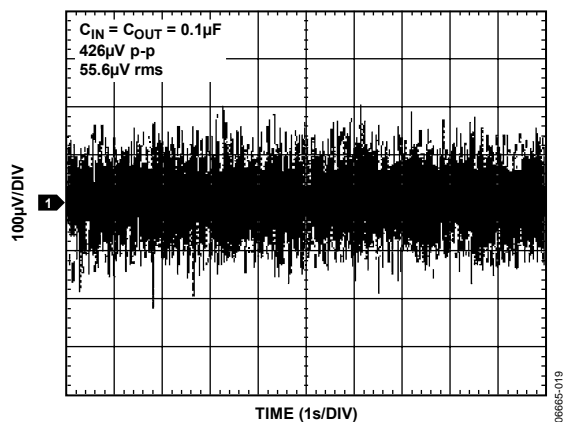

Figure 17. ADR821 10 Hz to 10 kHz Noise

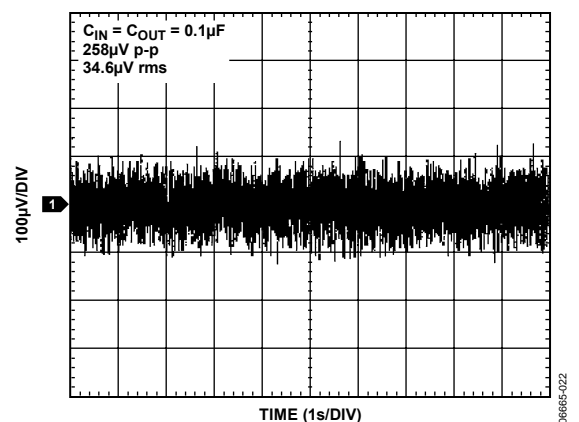

Figure 20. ADR827 10 Hz to 10 kHz Noise

ADR821/ADR827

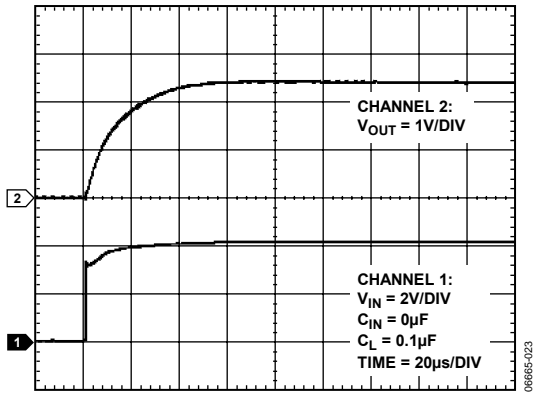

Figure 21. ADR821 Turn-On Response

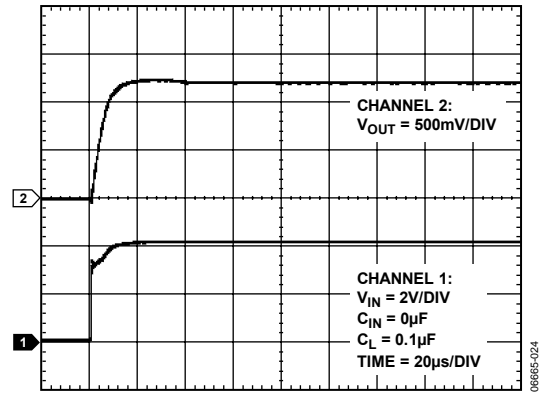

Figure 22. ADR827 Turn-On Response

AMPLIFIER (AD821/AD827)

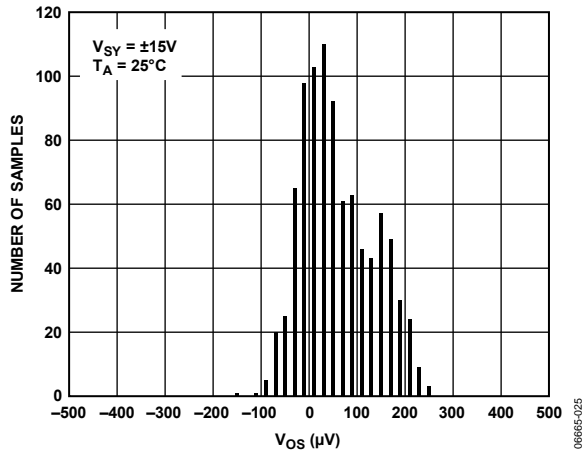

Figure 23. Input Offset Voltage Distribution

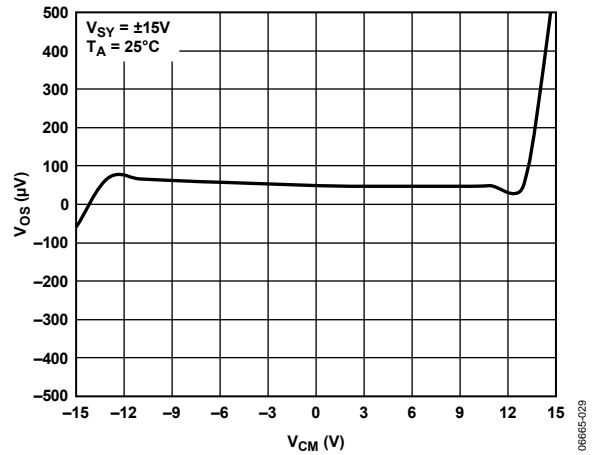

Figure 26. Input Offset Voltage vs. Common-Mode Voltage

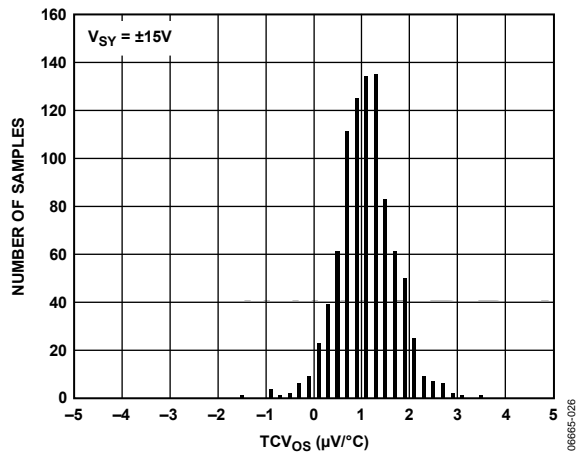

Figure 24. Offset Voltage Drift Distribution

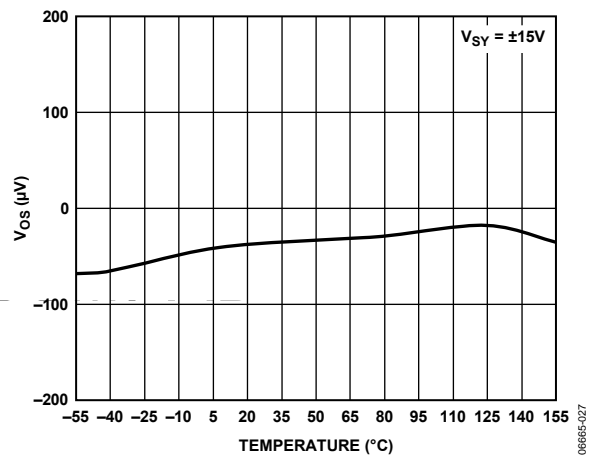

Figure 27. Input Offset Voltage vs. Temperature

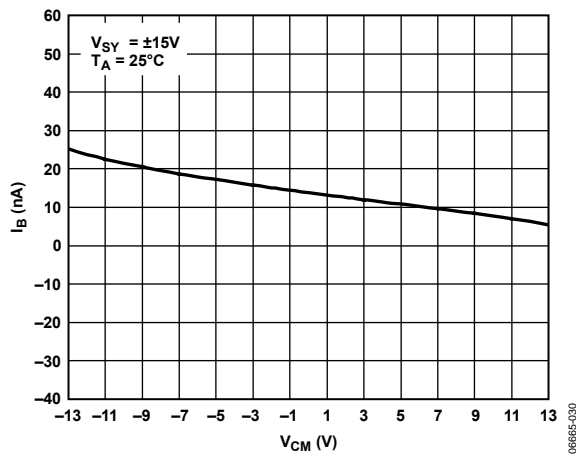

Figure 25. Input Bias Current vs. Common-Mode Voltage

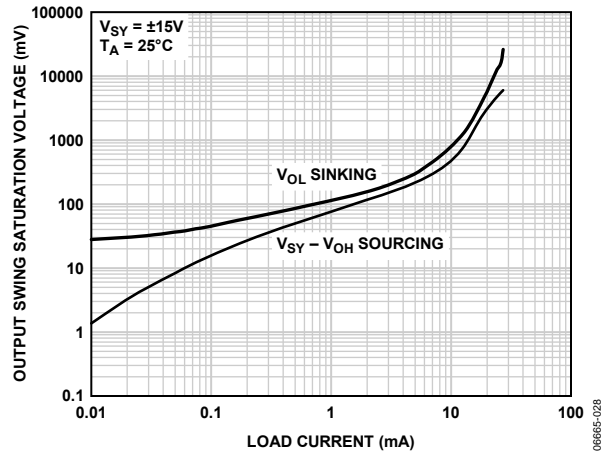

Figure 28. Output Swing Saturation Voltage vs. Load Current

ADR821/ADR827

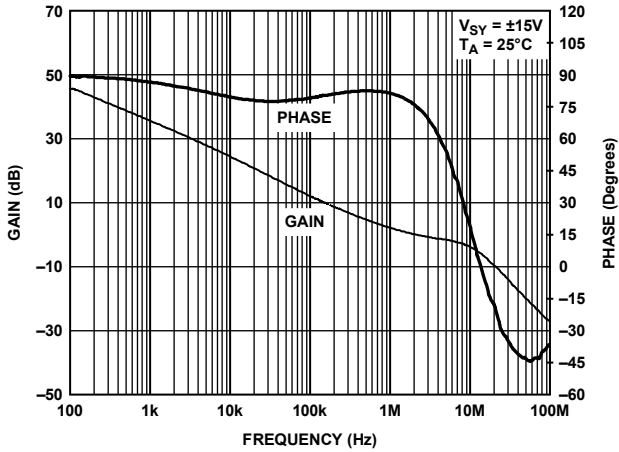

Figure 29. Open-Loop Gain and Phase vs. Frequency

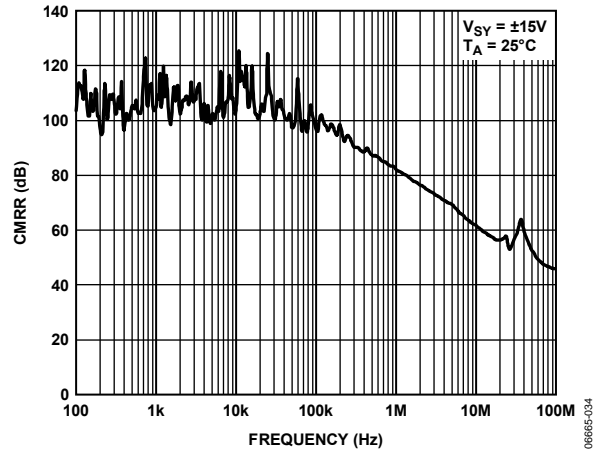

Figure 32. CMRR vs. Frequency

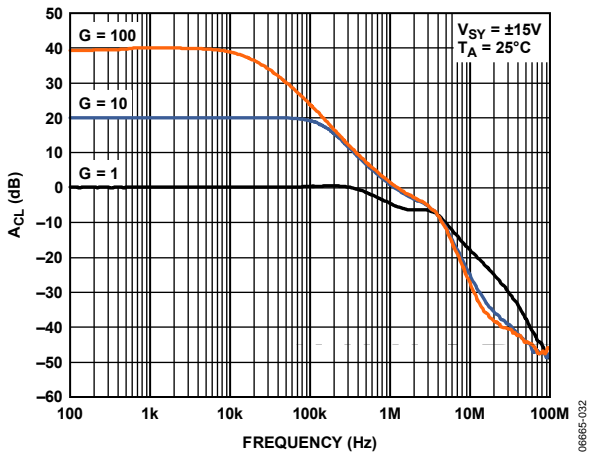

Figure 30. Closed-Loop Gain vs. Frequency

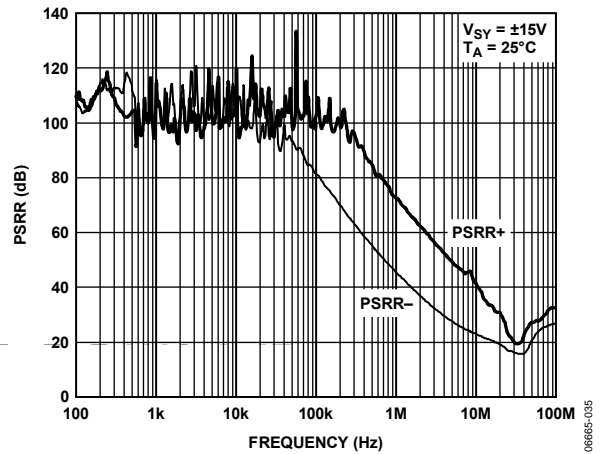

Figure 33. PSRR vs. Frequency

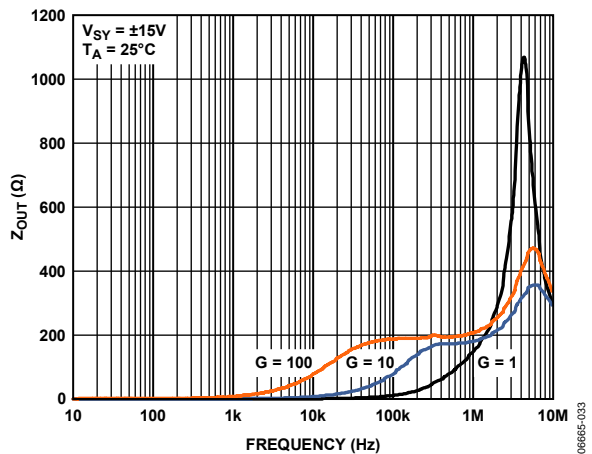

Figure 31. ZOUT vs. Frequency

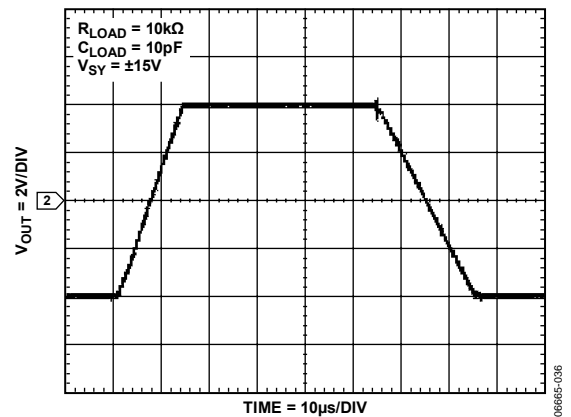

Figure 34. Large Signal Transient Response

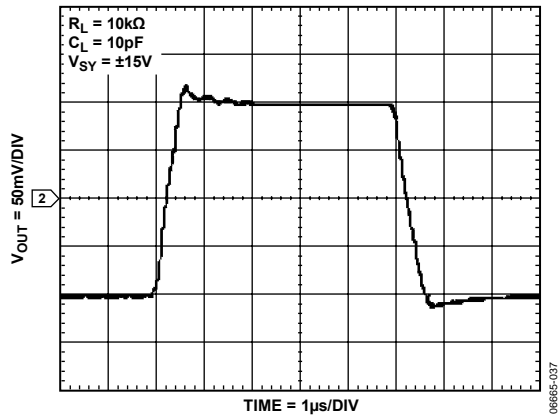

Figure 35. Small Signal Transient Response, $C_L = 10\text{ pF}$

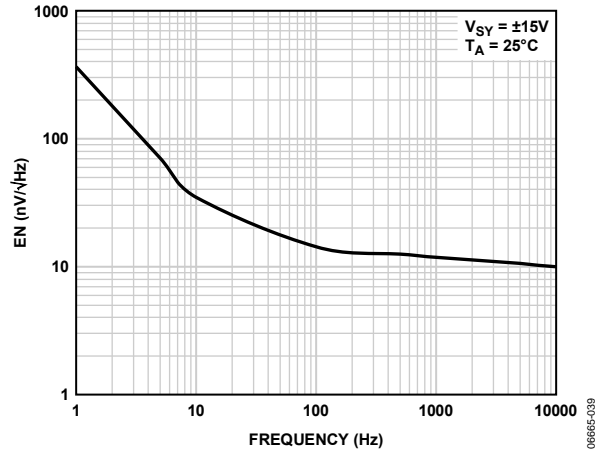

Figure 37. Voltage Noise Density

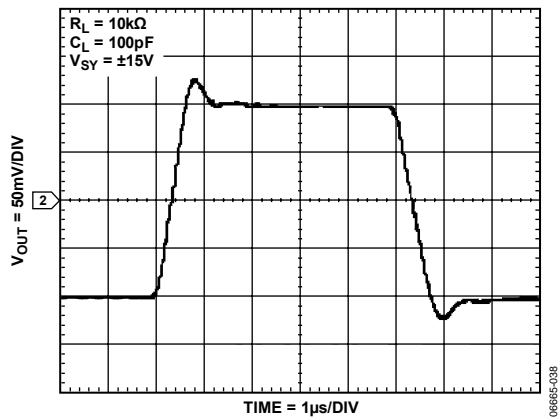

Figure 36. Small Signal Transient Response, $C_L = 100\text{ pF}$

APPLICATIONS INFORMATION

+2.5 V AND -2.5 V OUTPUTS (ADR821)

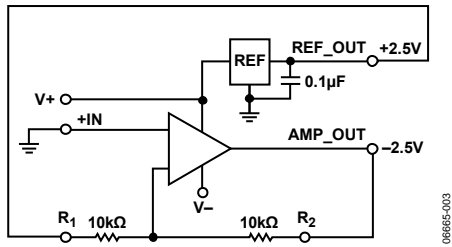

Figure 38. +2.5 V and -2.5 V Outputs

In many dual-supply applications, it is desirable to have ± 2.5 V references. Using the configuration shown in Figure 38, it is possible to generate -2.5 V with the help of a $+2.5$ V reference, an internal op amp, and 10 k Ω resistors. The supply voltages $V+$ and $V-$ should be greater than $+2.8$ V and -2.8 V, respectively. The op amp is configured as an inverting amplifier with a gain of -1 , which produces -2.5 V at the output of the op amp. The output of the reference is fed to the amplifier inverting input. Because the op amp has very low input offset voltage (500 μ V over the full temperature range) and the TC ratio of the resistors is typically ± 25 ppm/ $^{\circ}$ C, the -2.5 V output is less than 7 mV away from the theoretical value.

2.5 V AND 5.0 V OUTPUTS (ADR821)

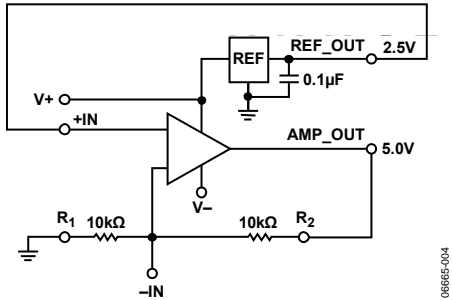

Figure 39. 2.5 V and 5.0 V Outputs

In many single-supply applications, it is desirable to have multiple reference voltages. Using the configuration shown in Figure 39, it is possible to generate 5.0 V with the help of a 2.5 V reference, an internal op amp, and resistors. $V+$ should be kept at greater than 5.8 V and $V-$ can be connected either to ground or to negative supply. The output of the reference is

fed to the amplifier noninverting input. The op amp is configured as a noninverting amplifier with a gain of $+2$, which produces 5 V at the output of the op amp. Using the guaranteed maximum offset voltage over the temperature, and the typical TC ratio of the resistors over the full temperature range, the output is within 15 mV of the calculated value.

MULTIPLE 2.5 V OUTPUTS (ADR821)

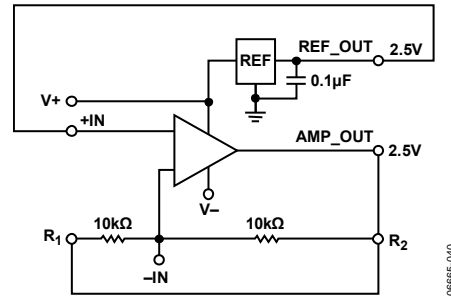
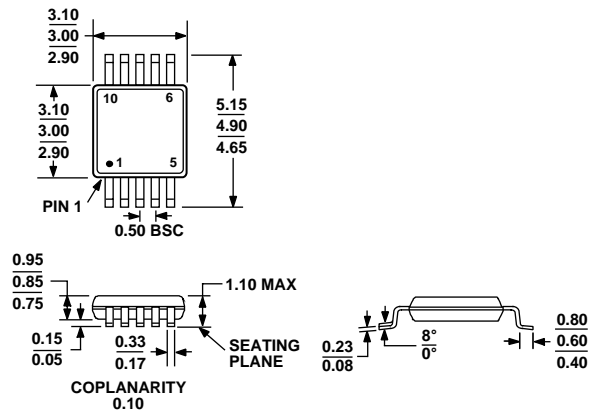

Figure 40. Multiple 2.5 V Outputs

On some boards, sensitive analog circuits, such as a VCO, exist with noisy digital circuits. If the supply current requirements are low (less than 3 mA), series references and op amps can be used. Using the configuration shown in Figure 40, two different 2.5 V supplies can be created using a single ADR821. The supply voltage $V+$ should be greater than 2.8 V and $V-$ can be connected to ground or a negative voltage. The op amp is configured as a voltage follower with a gain of $+1$, which produces 2.5 V at the output of the op amp. The output of the reference is fed to the amplifier noninverting input. Because the op amp has very low input offset voltage (500 μ V maximum over the full temperature range), the output voltage from the op amp section tracks the reference voltage within 1 mV. For a dynamic load, such as the reference input pin on some analog-to-digital converters, the load should be connected to an op amp output and the noise sensitive circuitry, such as a VCO, should be connected to the reference output. If the dynamic load is connected to the reference voltage, any perturbations appear as a signal to the input of the voltage follower and appear on the other output.

OUTLINE DIMENSIONS



COMPLIANT TO JEDEC STANDARDS MO-187-BA

Figure 41. 10-Lead Mini Small Outline Package [MSOP] (RM-10)

Dimensions shown in millimeters

ORDERING GUIDE

Models	Temperature Range	Output Voltage (V _{out})	Initial Accuracy		Temperature Coefficient (ppm/°C)	Package Description	Package Option	Ordering Quantity	Branding
			(mV)	(%)					
ADR821ARMZ-REEL7 ¹	-40°C to +125°C	2.500	10.00	±0.40	30	10-Lead MSOP	RM-10	1,000	R2G
ADR821ARMZ-R2 ¹	-40°C to +125°C	2.500	10.00	±0.40	30	10-Lead MSOP	RM-10	250	R2G
ADR821BRMZ-REEL7 ¹	-40°C to +125°C	2.500	5.00	±0.20	15	10-Lead MSOP	RM-10	1,000	R2H
ADR821BRMZ-R2 ¹	-40°C to +125°C	2.500	5.00	±0.20	15	10-Lead MSOP	RM-10	250	R2H
ADR827ARMZ-REEL7 ¹	-40°C to +125°C	1.250	5.00	±0.40	30	10-Lead MSOP	RM-10	1,000	ROZ
ADR827ARMZ-R2 ¹	-40°C to +125°C	1.250	5.00	±0.40	30	10-Lead MSOP	RM-10	250	ROZ
ADR827BRMZ-REEL7 ¹	-40°C to +125°C	1.250	2.50	±0.20	15	10-Lead MSOP	RM-10	1,000	R2B
ADR827BRMZ-R2 ¹	-40°C to +125°C	1.250	2.50	±0.20	15	10-Lead MSOP	RM-10	250	R2B

¹ Z = RoHS Compliant Part.

NOTES