

MITSUBISHI DIODE MODULES  
**RM500HA-M,-H,-24,-2H**

HIGH POWER GENERAL USE  
 INSULATED TYPE

RM500HA-M,-H,-24,-2H



- **IF(AV)** Average forward current ..... **500A**
- **VRRM** Repetitive peak reverse voltage  
 ..... **400/800/1200/1600V**
- **ONE ARM**
- **Insulated Type**

**APPLICATION**

AC motor controllers, DC motor controllers, Battery DC power supplies,  
 DC power supplies for control panels, and other general DC power equipment

**OUTLINE DRAWING & CIRCUIT DIAGRAM**

Dimensions in mm

[www.BDTIC.com/MITSUBISHI](http://www.BDTIC.com/MITSUBISHI)

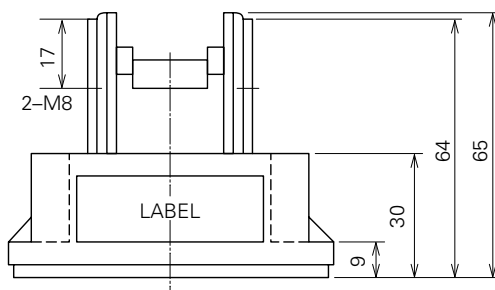
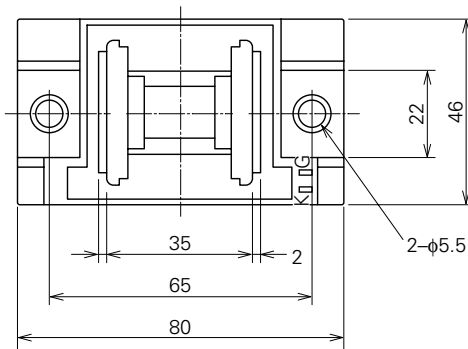

**RM500HA-M,-H,-24,-2H**

**HIGH POWER GENERAL USE  
INSULATED TYPE**

**ABSOLUTE MAXIMUM RATINGS**

Symbol	Parameter	Voltage class				Unit
		M	H	24	2H	
VRRM	Repetitive peak reverse voltage	400	800	1200	1600	V
VRSM	Non-repetitive peak reverse voltage	480	960	1350	1700	V
VR (DC)	Reverse DC voltage	320	640	960	1280	V

Symbol	Parameter	Conditions	Rated Values	Unit
IF (RMS)	RMS forward current		785	A
IF (AV)	Average forward current	Single-phase, half-wave 180° conduction, Tc=90°C	500	A
IFSM	Surge (non-repetitive) forward current	One half cycle at 60Hz, peak value	10000	A
I <sup>2</sup> t	I <sup>2</sup> t for fusing	Value for one cycle of surge current	4.2 × 10 <sup>5</sup>	A <sup>2</sup> s
f	Maximum operating frequency		1000	Hz
Tj	Junction temperature		-40~+150	°C
Tstg	Storage temperature		-40~+125	°C
Viso	Isolation voltage	Charged part to case	2500	V
—	Mounting torque	Main terminal screw M8	8.83~10.8	N·m
			90~110	kg·cm
		Mounting screw M6	1.47~1.96	N·m
—	Weight	Typical value	15~20	kg·cm
			450	g

**ELECTRICAL CHARACTERISTICS**

www.BDTIC.com/MITSUBISHI

Symbol	Parameter	Test conditions	Limits			Unit
			Min.	Typ.	Max.	
I <sub>RRM</sub>	Repetitive reverse current	T <sub>j</sub> =150°C, V <sub>RRM</sub> applied	—	—	40	mA
V <sub>FM</sub>	Forward voltage	T <sub>j</sub> =25°C, I <sub>FM</sub> =1500A, instantaneous meas.	—	—	1.25	V
R <sub>th (j-c)</sub>	Thermal resistance	Junction to case (per 1/2 module)	—	—	0.1	°C/W
R <sub>th (c-f)</sub>	Contact thermal resistance	Case to fin, conductive grease applied (per 1/2 module)	—	—	0.08	°C/W
—	Insulation resistance	Measured with a 500V megohmmeter between main terminal and case	10	—	—	MΩ

# RM500HA-M,-H,-24.-2H

HIGH POWER GENERAL USE  
INSULATED TYPE

## PERFORMANCE CURVES

**MAXIMUM FORWARD CHARACTERISTIC**

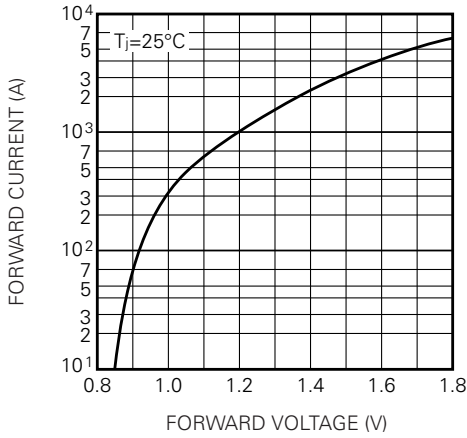

**ALLOWABLE SURGE (NON-REPETITIVE) FORWARD CURRENT**

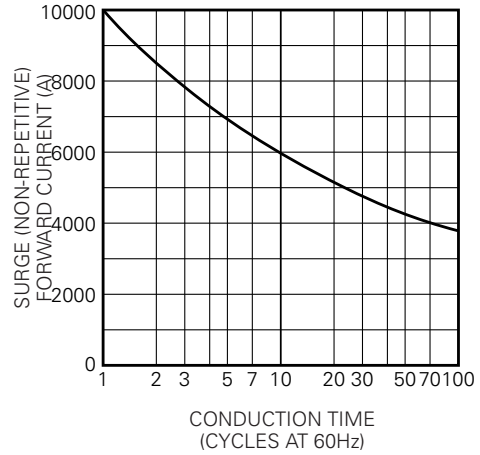

**MAXIMUM TRANSIENT THERMAL IMPEDANCE (JUNCTION TO CASE)**

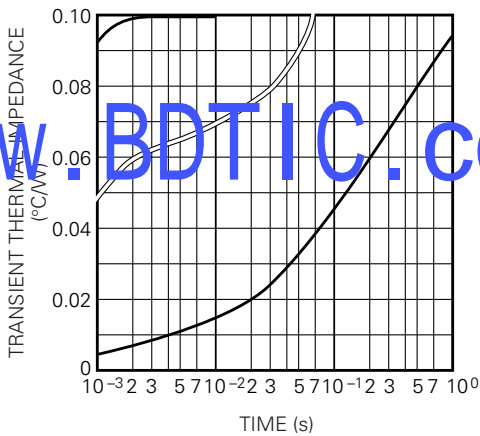

**MAXIMUM POWER DISSIPATION**

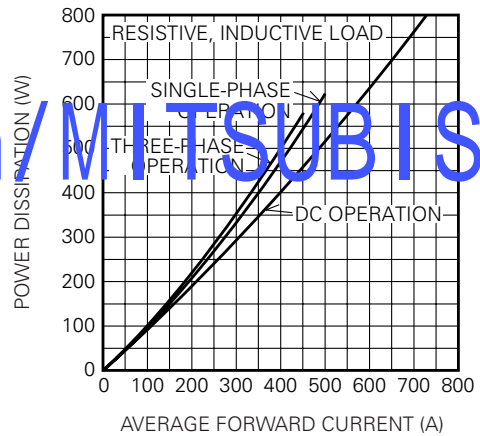

**ALLOWABLE CASE TEMPERATURE VS. AVERAGE FORWARD CURRENT**

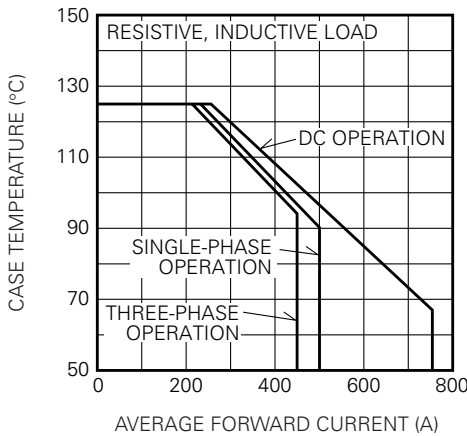

www.BDTIC.com/MITSUBISHI