

NUF2030XV6, NUF2042XV6

USB Upstream Terminator with ESD Protection

These devices are designed for applications requiring **Line Termination, EMI Filtering** and **ESD Protection**. They are intended for use in upstream USB ports, cellular phones, wireless equipment and computer applications. These devices offer an integrated solution in a small package (SOT-563) reducing PCB space and cost.

Features:

- Provides USB Line Termination, Filtering and ESD Protection
- Single IC Offers Cost Savings
- Bidirectional EMI Filtering Prevents Noise from Entering/Leaving the System
- Compliance with IEC61000-4-2 (Level 4)
8 kV (Contact)
15 kV (Air)
- ESD Ratings: Machine Model = C
Human Body Model = 3B
- These are Pb-Free Devices

Benefits:

- SOT-563 Package Minimizes PCB Space
- Integrated Circuit Increases System Reliability versus Discrete Component Implementation
- TVs Devices Provide ESD Protection That is Better than a Discrete Implementation because the Small IC minimizes Parasitic Inductances

Typical Applications:

- USB Hubs
- Computer Peripherals Using USB

MAXIMUM RATINGS (T_A = 25°C)

Rating	Symbol	Value	Unit
Steady State Power	P _D	225	mW
Maximum Junction Temperature	T _{J(max)}	125	°C
Operating Temperature Range	T _J	-55 to +125	°C
Storage Temperature Range	T _{stg}	-55 to +125	°C
Lead Solder Temperature (10 second duration)	T _L	260	°C

Maximum ratings are those values beyond which device damage can occur. Maximum ratings applied to the device are individual stress limit values (not normal operating conditions) and are not valid simultaneously. If these limits are exceeded, device functional operation is not implied, damage may occur and reliability may be affected.



ON Semiconductor®

<http://onsemi.com>

CIRCUIT DESCRIPTION

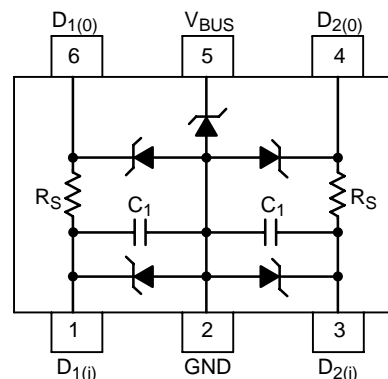

SOT-563
CASE 463A

MARKING DIAGRAM

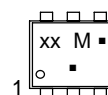

xx = Specific Device Code
(see table on page 5)
M = Month Code
▪ = Pb-Free Package
(Note: Microdot may be in either location)

ORDERING INFORMATION

See detailed ordering and shipping information in the package dimensions section on page 5 of this data sheet.

NUF2030XV6, NUF2042XV6

ELECTRICAL CHARACTERISTICS ($T_A = 25^\circ\text{C}$ unless otherwise noted)

Device	V_{RWM} (V)	V_{BR} @ 1 mA (V)			I_R @ 3.3 V (nA)			Line Capacitance Vdc = 2.5 V f = 1 MHz (pF) (Note 1)			Series Resistor R_S (Ω)		
		Min	Typ	Max	Min	Typ	Max	Min	Typ	Max	Min	Typ	Max
NUF2030XV6T1	5.25	5.6	6.8	8.0	–	10	100	–	30	36	17.6	22	26.4
NUF2042XV6T1	5.25	5.6	6.8	8.0	–	10	100	37.6	42	56.4	17.6	22	26.4

1. Measured between pins 1, 3, 4, 6 and ground with pin 5 also grounded.
2. For other resistance value (e.g. 33 Ω), please contact your local ON Semiconductor sales representative.

www.BDTIC.com/ON

NUF2030XV6, NUF2042XV6

TYPICAL CHARACTERISTICS

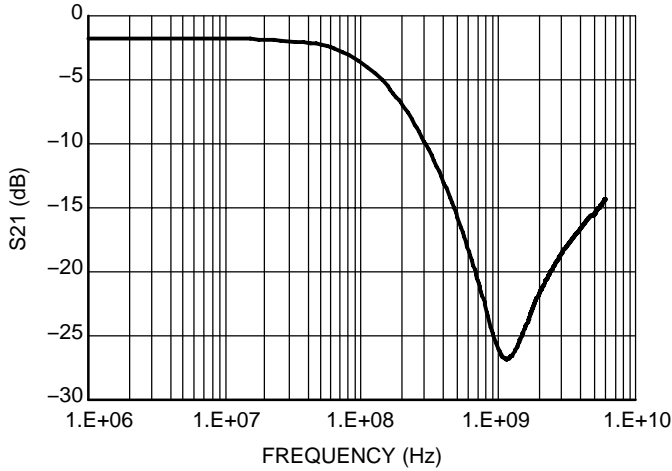

Figure 1. Insertion Loss Characteristics (NUF2030)

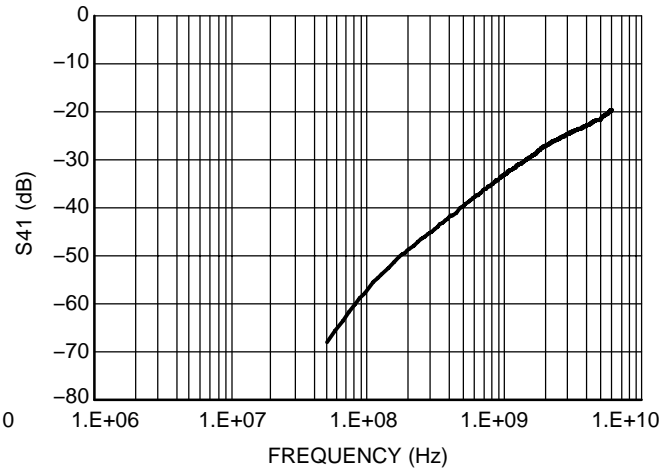

Figure 2. Analog Cross-Talk (NUF2030)

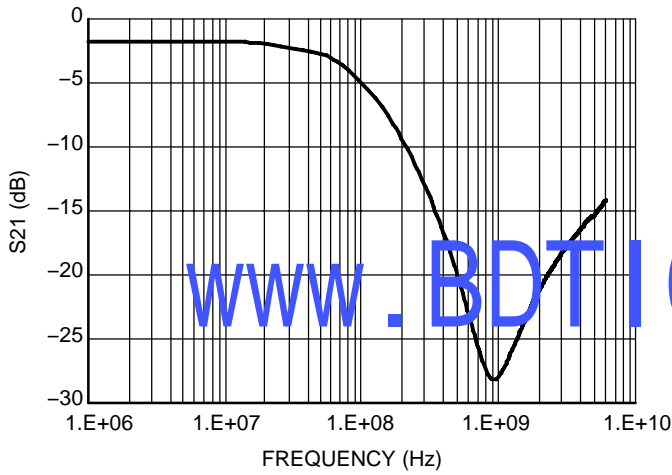

Figure 3. Insertion Loss Characteristics (NUF2042)

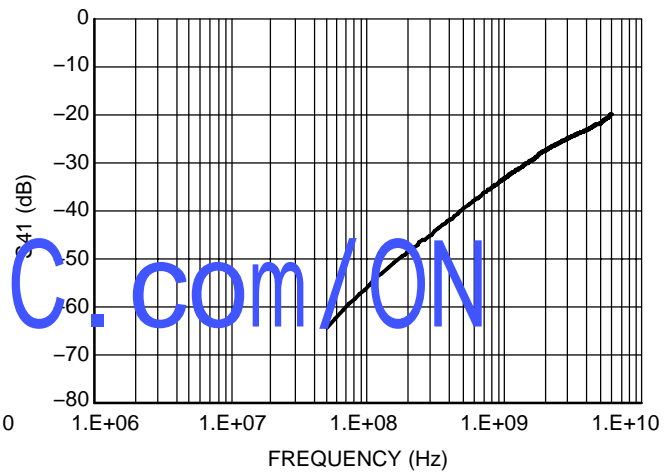

Figure 4. Analog Cross-Talk (NUF2042)

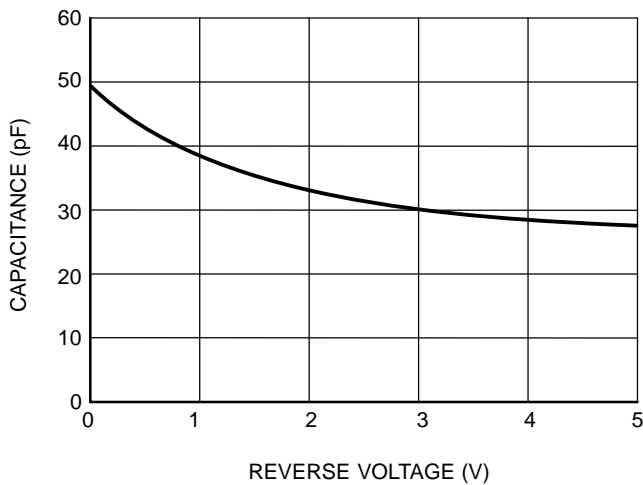

Figure 5. Typical Capacitance (NUF2030)

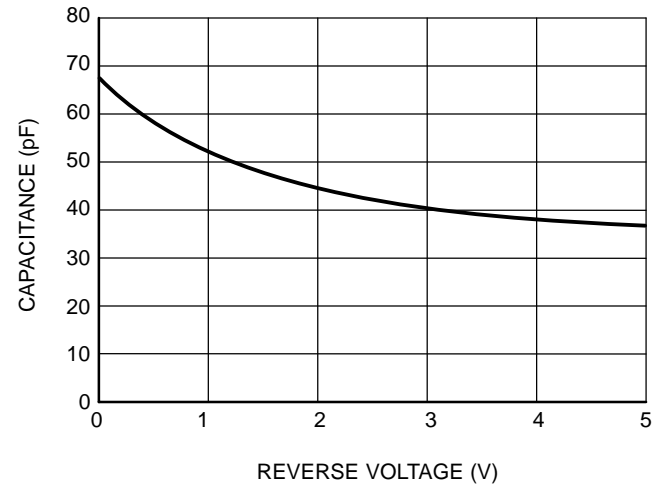

Figure 6. Typical Capacitance (NUF2042)

NUF2030XV6, NUF2042XV6

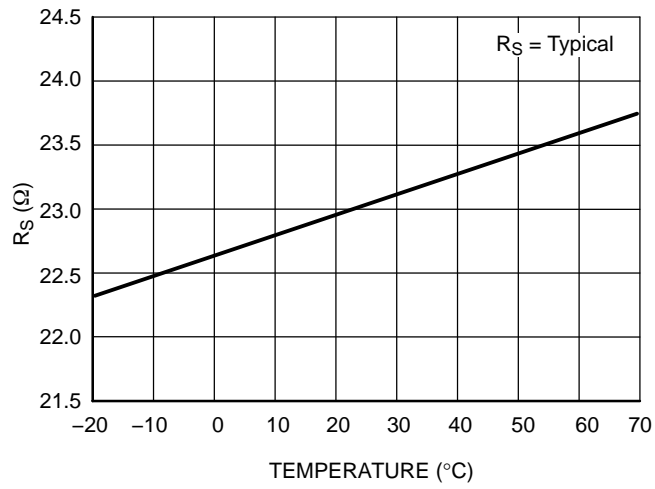

Figure 7. R_S versus Temperature
(NUF2030 and NUF2042)

www.BDTIC.com/ON

NUF2030XV6, NUF2042XV6

ORDERING INFORMATION

Device	Device Marking	Package	Shipping†
NUF2030XV6T1	30	SOT-563*	4000 / Tape & Reel
NUF2030XV6T1G	30	SOT-563*	4000 / Tape & Reel
NUF2042XV6T1	22	SOT-563*	4000 / Tape & Reel
NUF2042XV6T1G	22	SOT-563*	4000 / Tape & Reel

†For information on tape and reel specifications, including part orientation and tape sizes, please refer to our Tape and Reel Packaging Specifications Brochure, BRD8011/D.

*These packages are inherently Pb-Free.

www.BDTIC.com/ON

NUF2030XV6, NUF2042XV6

PACKAGE DIMENSIONS

SOT-563, 6 LEAD
CASE 463A-01
ISSUE E

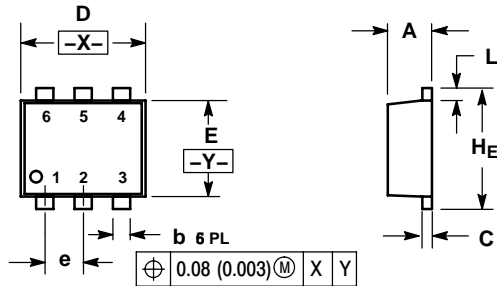

NOTES:

1. DIMENSIONING AND TOLERANCING PER ANSI Y14.5M, 1982.
2. CONTROLLING DIMENSION: MILLIMETERS
3. MAXIMUM LEAD THICKNESS INCLUDES LEAD FINISH THICKNESS. MINIMUM LEAD THICKNESS IS THE MINIMUM THICKNESS OF BASE MATERIAL.

DIM	MILLIMETERS			INCHES		
	MIN	NOM	MAX	MIN	NOM	MAX
A	0.50	0.55	0.60	0.020	0.021	0.023
b	0.17	0.22	0.27	0.007	0.009	0.011
C	0.08	0.12	0.18	0.003	0.005	0.007
D	1.50	1.60	1.70	0.059	0.062	0.066
E	1.10	1.20	1.30	0.043	0.047	0.051
e	0.5 BSC			0.02 BSC		
L	0.10	0.20	0.30	0.004	0.008	0.012
HE	1.50	1.60	1.70	0.059	0.062	0.066

SOLDERING FOOTPRINT*

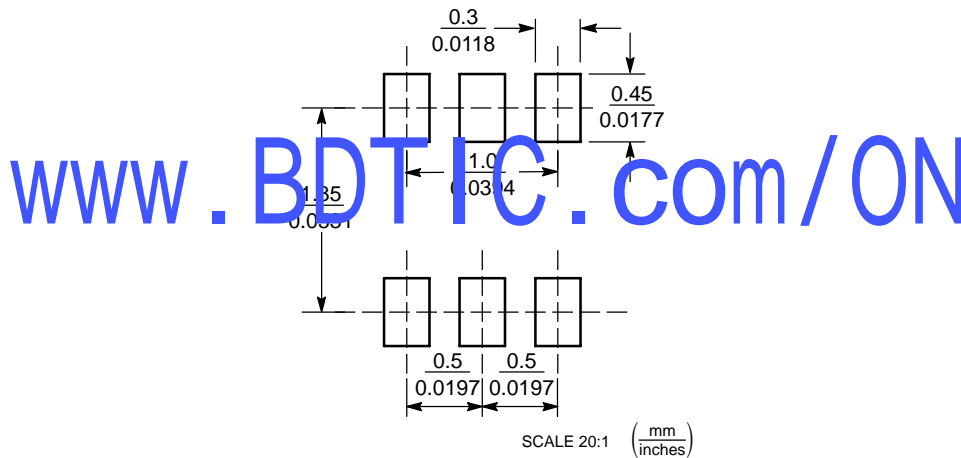

*For additional information on our Pb-Free strategy and soldering details, please download the ON Semiconductor Soldering and Mounting Techniques Reference Manual, SOLDERRM/D.

ON Semiconductor and are registered trademarks of Semiconductor Components Industries, LLC (SCILLC). SCILLC reserves the right to make changes without further notice to any products herein. SCILLC makes no warranty, representation or guarantee regarding the suitability of its products for any particular purpose, nor does SCILLC assume any liability arising out of the application or use of any product or circuit, and specifically disclaims any and all liability, including without limitation special, consequential or incidental damages. "Typical" parameters which may be provided in SCILLC data sheets and/or specifications can and do vary in different applications and actual performance may vary over time. All operating parameters, including "Typicals" must be validated for each customer application by customer's technical experts. SCILLC does not convey any license under its patent rights nor the rights of others. SCILLC products are not designed, intended, or authorized for use as components in systems intended for surgical implant into the body, or other applications intended to support or sustain life, or for any other application in which the failure of the SCILLC product could create a situation where personal injury or death may occur. Should Buyer purchase or use SCILLC products for any such unintended or unauthorized application, Buyer shall indemnify and hold SCILLC and its officers, employees, subsidiaries, affiliates, and distributors harmless against all claims, costs, damages, and expenses, and reasonable attorney fees arising out of, directly or indirectly, any claim of personal injury or death associated with such unintended or unauthorized use, even if such claim alleges that SCILLC was negligent regarding the design or manufacture of the part. SCILLC is an Equal Opportunity/Affirmative Action Employer. This literature is subject to all applicable copyright laws and is not for resale in any manner.

PUBLICATION ORDERING INFORMATION

LITERATURE FULFILLMENT:
Literature Distribution Center for ON Semiconductor
P.O. Box 61312, Phoenix, Arizona 85082-1312 USA
Phone: 480-829-7710 or 800-344-3860 Toll Free USA/Canada
Fax: 480-829-7709 or 800-344-3867 Toll Free USA/Canada
Email: orderlit@onsemi.com

N. American Technical Support: 800-282-9855 Toll Free
USA/Canada

Japan: ON Semiconductor, Japan Customer Focus Center
2-9-1 Kamimeguro, Meguro-ku, Tokyo, Japan 153-0051
Phone: 81-3-5773-3850

ON Semiconductor Website: <http://onsemi.com>

Order Literature: <http://www.onsemi.com/litorder>

For additional information, please contact your local Sales Representative.