



MAXIM

350MHz, Ultra-Low-Noise Op Amps

General Description

The MAX4106/MAX4107 op amps combine high-speed performance with ultra-low-noise performance. The MAX4106 is compensated for closed-loop gains of 5V/V, while the MAX4107 is stable in closed-loop gains of 10V/V or greater.

The MAX4106/MAX4107 require only 15mA of supply current while delivering a 350MHz or a 300MHz bandwidth, respectively. Voltage noise is an ultra-low 0.75nV/√Hz, while a low-distortion architecture provides a spurious-free dynamic range (SFDR) of 63dB at 5MHz.

These high-speed op amps have a wide output voltage swing of ±3.2V and a high current-drive capability of 80mA.

Applications

- Ultra-Low-Noise ADC Preamp
- Ultrasound
- Low-Noise Preamplifier
- High-Performance Receivers
- Active Filters
- Pulse/RF Amplifier

Typical Application Circuit

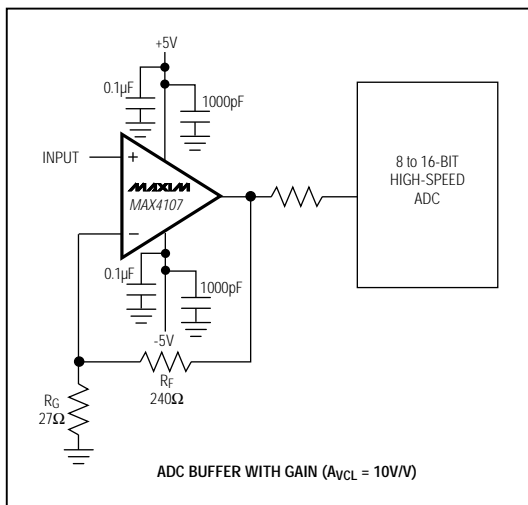

Features

- ♦ 350MHz -3dB Bandwidth (MAX4106)
- ♦ 275V/μs Slew Rate (MAX4106)
500V/μs Slew Rate (MAX4107)
- ♦ 18ns Settling Time to 0.01%
- ♦ 0.75nV/√Hz Voltage Noise
- ♦ High Output Drive: 80mA

Ordering Information

PART	TEMP. RANGE	PIN-PACKAGE
MAX4106ESA	-40°C to +85°C	8 SO
MAX4107ESA	-40°C to +85°C	8 SO

Pin Configuration

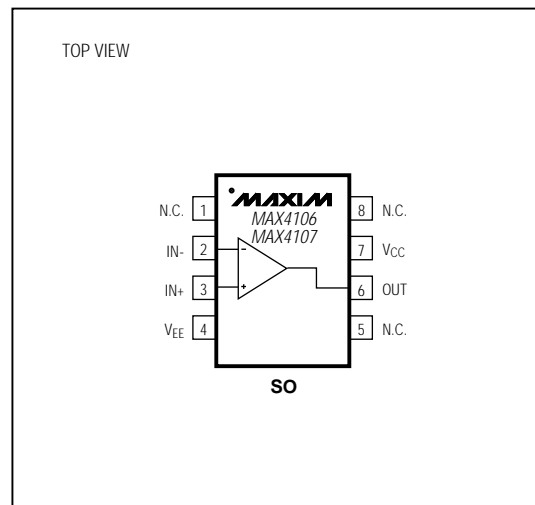

MAX4106/MAX4107

MAXIM

Maxim Integrated Products 1

Call toll free 1-800-998-8800 for free samples or literature.

350MHz, Ultra-Low-Noise Op Amps

ABSOLUTE MAXIMUM RATINGS

Power-Supply Voltage (V_{CC} to V_{EE}).....	12V	Operating Temperature Range	
Voltage on Any Pin to Ground or Any Other Pin.....	V_{CC} to V_{EE}	MAX4106ESA/MAX4107ESA.....	-40°C to +85°C
Short-Circuit Duration (V_{OUT} to GND).....	Continuous	Storage Temperature Range.....	-65°C to +160°C
Continuous Power Dissipation ($T_A = +70^\circ\text{C}$)		Junction Temperature.....	+150°C
SO (derate 5.88mW/°C above +70°C).....	471mW	Lead Temperature (soldering, 10sec).....	+300°C

Stresses beyond those listed under "Absolute Maximum Ratings" may cause permanent damage to the device. These are stress ratings only, and functional operation of the device at these or any other conditions beyond those indicated in the operational sections of the specifications is not implied. Exposure to absolute maximum rating conditions for extended periods may affect device reliability.

ELECTRICAL CHARACTERISTICS

($V_{CC} = 5\text{V}$, $V_{EE} = -5\text{V}$, $T_A = T_{MIN}$ to T_{MAX} , typical values are at $T_A = +25^\circ\text{C}$, unless otherwise noted.)

PARAMETER	SYMBOL	CONDITIONS	MIN	TYP	MAX	UNITS
DC SPECIFICATIONS						
Input Offset Voltage	V_{OS}	$V_{OUT} = 0\text{V}$		0.250	3	mV
Input Offset Voltage Drift	TCV_{OS}	$V_{OUT} = 0\text{V}$		1.0		$\mu\text{V}/^\circ\text{C}$
Input Bias Current	I_B	$V_{OUT} = 0\text{V}$, $V_{IN} = -V_{OS}$		18	26	μA
Input Offset Current	I_{OS}	$V_{OUT} = 0\text{V}$, $V_{IN} = -V_{OS}$		0.05	2	μA
Common-Mode Input Resistance	R_{INCM}	Either input		1		$\text{M}\Omega$
Common-Mode Input Capacitance	C_{INCM}	Either input		1		pF
Input Voltage Noise	e_n	$f = 10\text{kHz}$		0.75		$\text{nV}/\sqrt{\text{Hz}}$
Integrated Voltage Noise	E_{nRMS}	$f = 1\text{MHz to } 100\text{MHz}$		9.5		μVRMS
Input Current Noise	i_n	$f = 10\text{kHz}$		2.5		$\text{pA}/\sqrt{\text{Hz}}$
Integrated Current Noise	i_{nRMS}	$f = 1\text{MHz to } 100\text{MHz}$		31		nARMS
Common-Mode Input Voltage	V_{CM}		-2.5		2.5	V
Common-Mode Rejection	CMR	$V_{CM} = \pm 2.5\text{V}$	70	100		dB
Power-Supply Rejection	PSR	$V_S = \pm 4.5\text{V to } \pm 5.5\text{V}$	75	100		dB
Open-Loop Voltage Gain	A_{VOL}	$V_{OUT} = \pm 2.0\text{V}$, $V_{CM} = 0\text{V}$	$R_L = \infty$	80	100	dB
			$R_L = 100\Omega$	80	100	
Supply Current	I_S	$V_{IN} = 0\text{V}$		15	19	mA
Output Voltage Swing	V_{OUT}	$R_L = \infty$	± 3.2	± 3.8	V	
		$R_L = 100\Omega$	± 3.0	± 3.5		
Output Current Drive	I_{OUT}	$R_L = 30\Omega$, $T_A = 0^\circ\text{C to } +85^\circ\text{C}$	65	80		mA
Short-Circuit Output Current	I_{SC}	Short to ground		90		mA

350MHz, Ultra-Low-Noise Op Amps

MAX4106/MAX4107

ELECTRICAL CHARACTERISTICS (continued)

($V_{CC} = 5V$, $V_{EE} = -5V$, $T_A = T_{MIN}$ to T_{MAX} , typical values are at $T_A = +25^\circ C$, unless otherwise noted.)

PARAMETER	SYMBOL	CONDITIONS	MIN	TYP	MAX	UNITS
AC SPECIFICATIONS						
-3dB Bandwidth	BW _{-3dB}	$V_{OUT} \leq 0.1V_{RMS}$	MAX4106	350		MHz
			MAX4107	300		
0.1dB Bandwidth	BW _{0.1dB}	MAX4106, $A_{VCL} = +5$		75		MHz
		MAX4107, $A_{VCL} = +10$		45		
Slew Rate	SR	$-2V \leq V_{OUT} \leq 2V$	MAX4106	275		V/ μ s
			MAX4107	500		
Settling Time	t_s	$-1V \leq V_{OUT} \leq 1V$, $R_L = 100\Omega$, to 0.1%	MAX4106	13		ns
			MAX4107	13		
		$-1V \leq V_{OUT} \leq 1V$, $R_L = 100\Omega$, to 0.01%	MAX4106	18		
			MAX4107	18		
Rise/Fall Times	t_r, t_f	10% to 90%, $-2V \leq V_{OUT} \leq 2V$, $R_L = 100\Omega$	MAX4106	13		ns
			MAX4107	6		
		10% to 90%, $-50mV \leq V_{OUT} \leq 50mV$, $R_L = 100\Omega$	MAX4106	1		
			MAX4107	1		
Differential Gain	DG	$f = 3.58MHz$	MAX4106, $A_{VCL} = +5$	0.04		%
			MAX4107, $A_{VCL} = +10$	0.03		
Differential Phase	DP	$f = 3.58MHz$	MAX4106, $A_{VCL} = +5$	0.02		degrees
			MAX4107, $A_{VCL} = +10$	0.03		
Input Capacitance	C_{IN}			2		pF
Output Impedance	Z_{OUT}	$f = 10MHz$		0.7		Ω
Spurious-Free Dynamic Range	SFDR	$f_C = 5MHz$, $V_{OUT} = 2V_{p-p}$	MAX4106, $A_{VCL} = +5$	63		dBc
			MAX4107, $A_{VCL} = +10$	60		
Two-Tone Third-Order Intercept	IP3	$f_C = 10MHz$		24		dBm

350MHz, Ultra-Low-Noise Op Amps

MAX4106/MAX4107

Typical Operating Characteristics

($V_{CC} = +5V$, $V_{EE} = -5V$, $R_L = 100\Omega$, $T_A = +25^\circ C$, unless otherwise noted.)

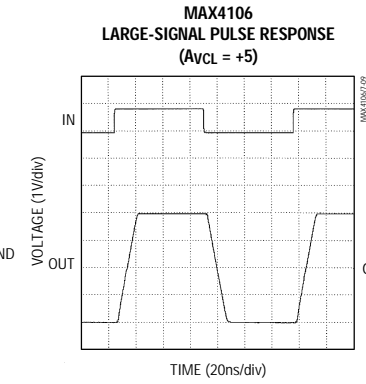
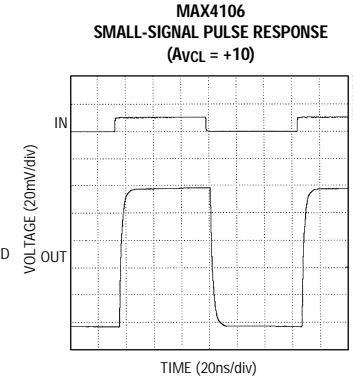
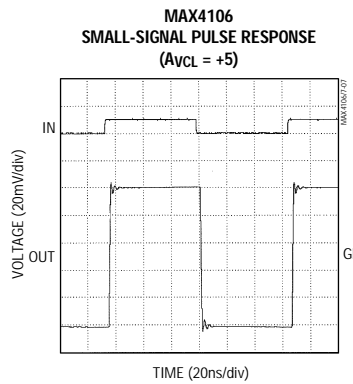
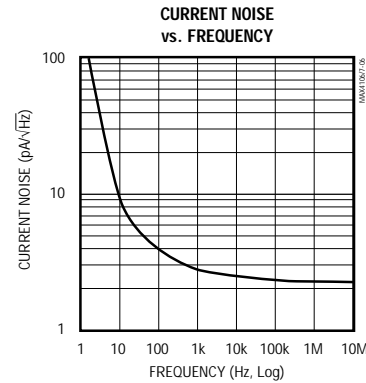
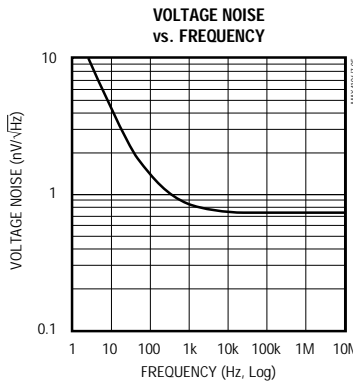
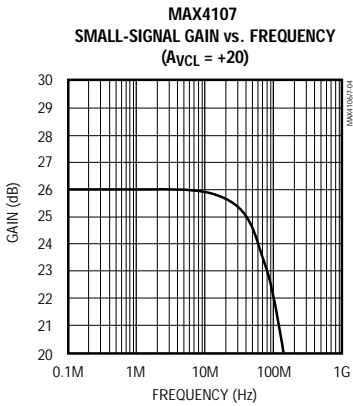
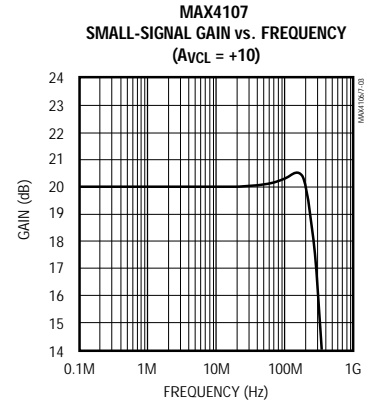
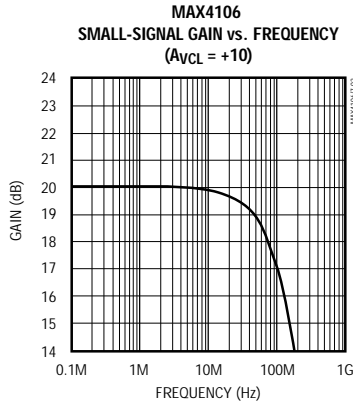
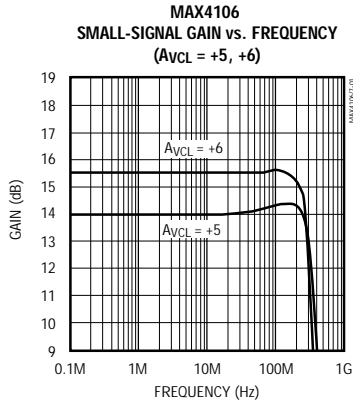

350MHz, Ultra-Low-Noise Op Amps

MAX4106/MAX4107

Typical Operating Characteristics (continued)
 (V_{CC} = +5V, V_{EE} = -5V, R_L = 100Ω, T_A = +25°C, unless otherwise noted.)

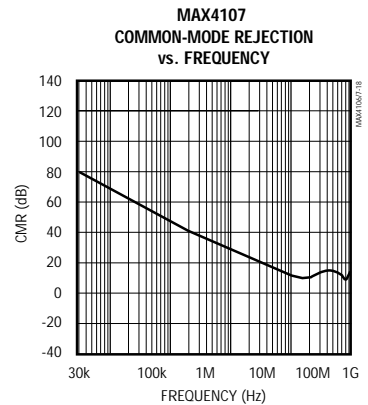
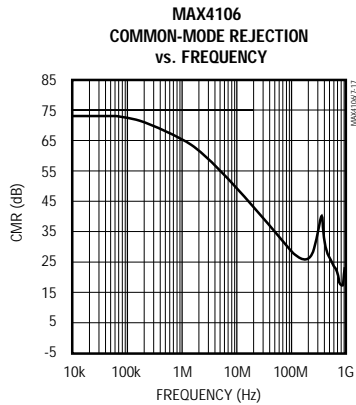
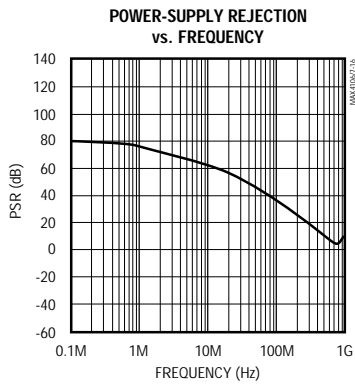
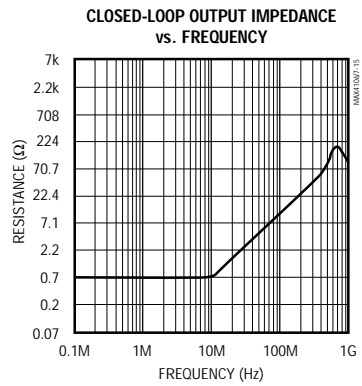
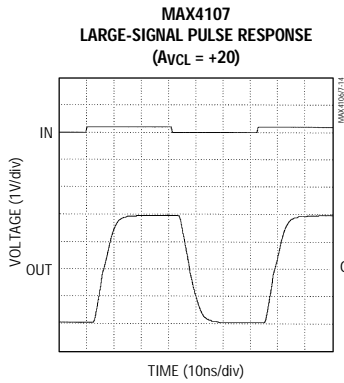
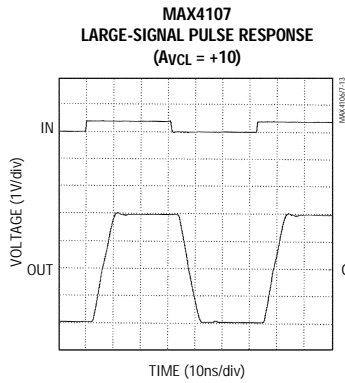
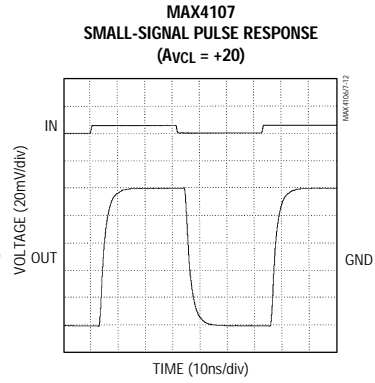
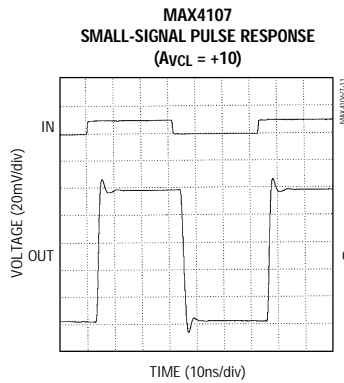
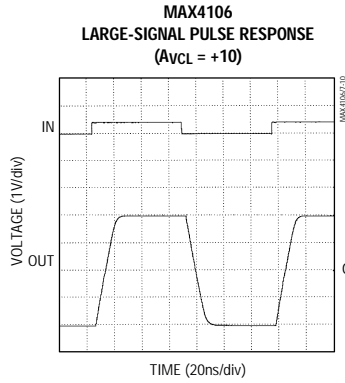

350MHz, Ultra-Low-Noise Op Amps

Typical Operating Characteristics (continued)

($V_{CC} = +5V$, $V_{EE} = -5V$, $R_L = 100\Omega$, $T_A = +25^\circ C$, unless otherwise noted.)

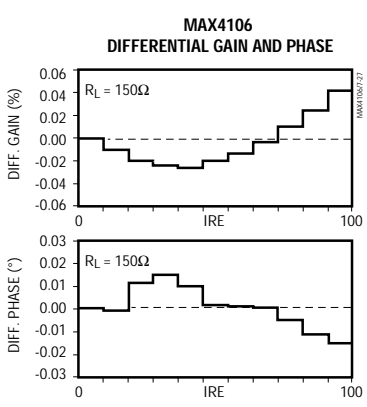
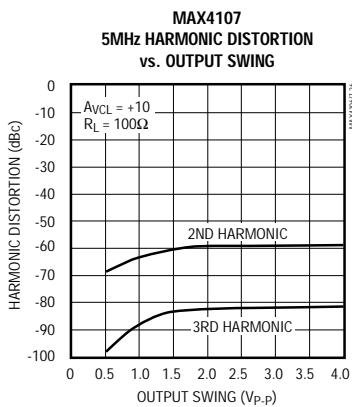
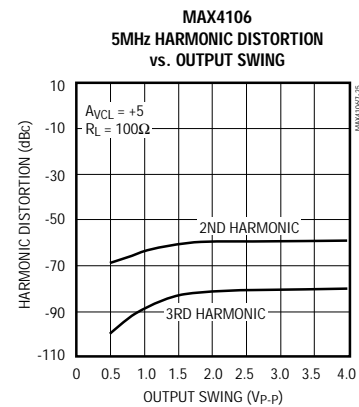
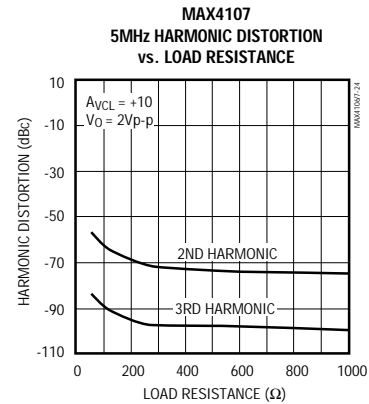
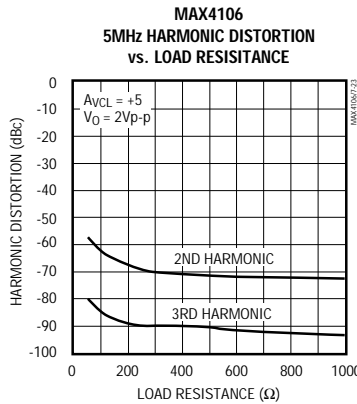
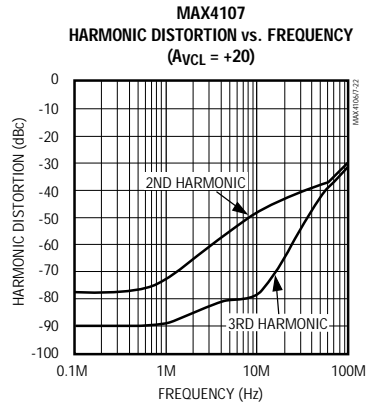
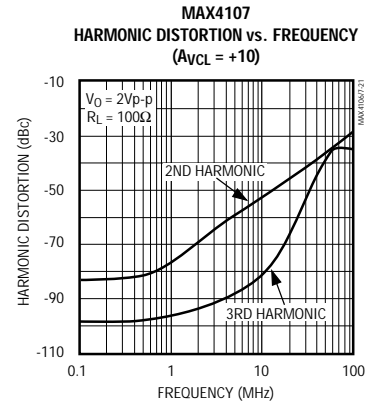
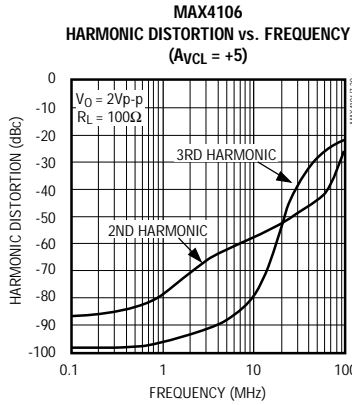
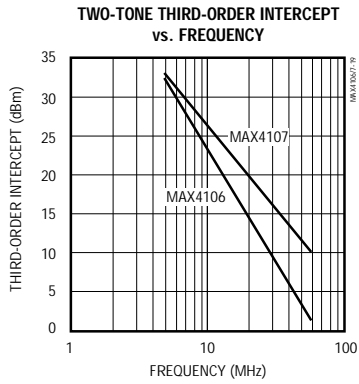

350MHz, Ultra-Low-Noise Op Amps

MAX4106/MAX4107

Typical Operating Characteristics (continued)
 (V_{CC} = +5V, V_{EE} = -5V, R_L = 100Ω, T_A = +25°C, unless otherwise noted.)

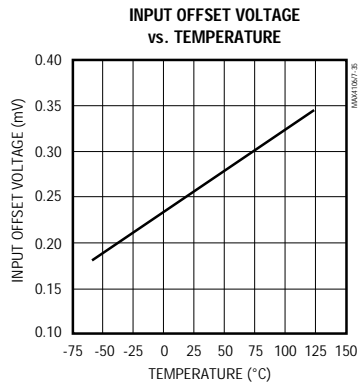
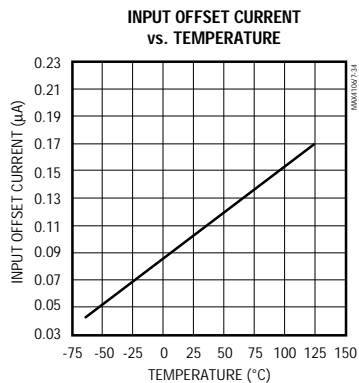
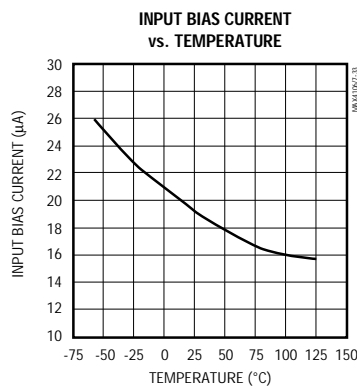
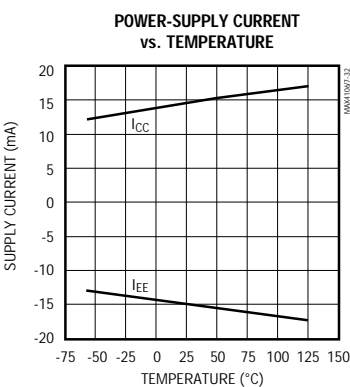
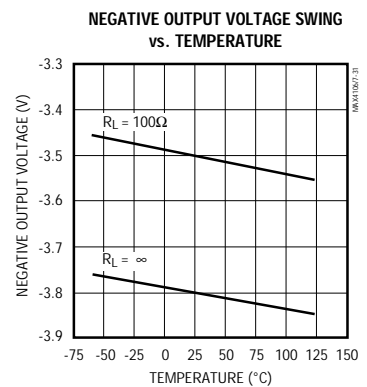
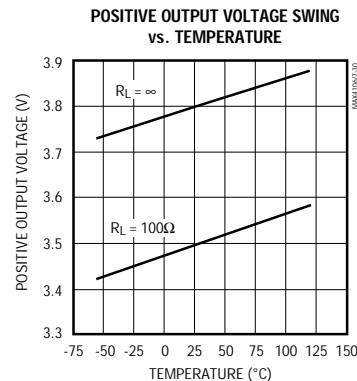
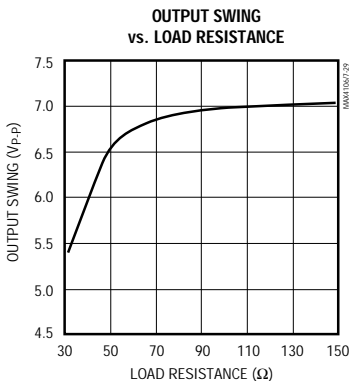
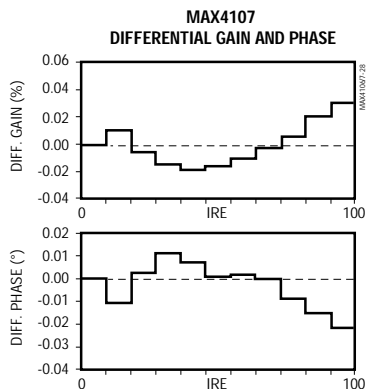

350MHz, Ultra-Low-Noise Op Amps

Pin Description

PIN	NAME	FUNCTION
1, 5, 8	N.C.	No Connection, not internally connected
2	IN-	Inverting Input
3	IN+	Noninverting Input
4	V _{EE}	Negative Power Supply, connect to -5V
6	OUT	Amplifier Output
7	V _{CC}	Positive Power Supply, connect to +5V

General Description

Choosing Resistor Values

The values of the gain-setting feedback and input resistors are important design considerations. Large resistor values will increase voltage noise, and will interact with the amplifier's input and PC board capacitance to generate undesirable poles and zeros, which can decrease bandwidth or cause oscillations. For example, a noninverting gain of +5 (MAX4106), using a 1k Ω feedback resistor combined with 2pF of input capacitance and 0.5pF of board capacitance, will cause a feedback pole at 318MHz. If this pole is within the anticipated amplifier bandwidth, it will jeopardize stability. Reducing the 1k Ω feedback resistor to 40 Ω will extend the pole frequency to 8GHz, but could limit output swing by adding 50 Ω in parallel with the amplifier's load. Clearly the selection of resistor values must be tailored to the specific application.

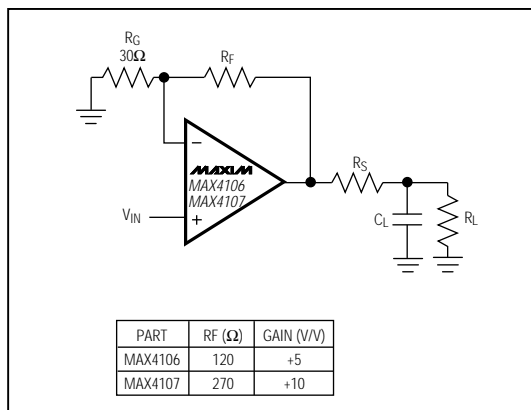

Figure 1a. Using an Isolation Resistor for High Capacitive Loads

The MAX4106/MAX4107 are ultra-low-noise, high-bandwidth op amps. The output noise voltage can be dominated by resistor thermal noise, so keep the feedback and input resistors small. Setting the input resistor to 30 Ω and choosing the feedback resistor to suit the gain will provide excellent AC performance without significantly degrading noise performance.

Driving Capacitive Loads

The MAX4106/MAX4107 are optimized for AC performance. They are not designed to drive highly reactive loads. Reactive loads will decrease phase margin and may produce excessive ringing and oscillation. Figure 1a shows a circuit that eliminates this problem, and Figure 1b is a graph of the optimal isolation resistor (R_S) vs. capacitive load. Figures 2a and 2b show how a capacitive load causes excessive peaking of the amplifier's bandwidth if the capacitive load is not isolated (R_S) from the amplifier. A small isolation resistor (usually 10 Ω to 20 Ω) placed before the reactive load prevents ringing and oscillation. At higher capacitive loads, AC performance will be controlled by the interaction of the load capacitance and isolation resistor. Figures 3a and 3b show the effect of an isolation resistor on the MAX4106/MAX4107 closed-loop response.

Coaxial cable and other transmission lines are easily driven when terminated at both ends with their characteristic impedance. When driving back-terminated transmission lines, the capacitance of the transmission line is essentially eliminated.

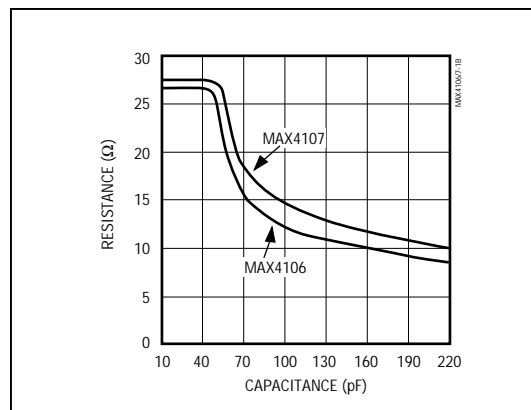

Figure 1b. Optimal Isolation Resistor (R_S) vs. Capacitive Load

350MHz, Ultra-Low-Noise Op Amps

MAX4106/MAX4107

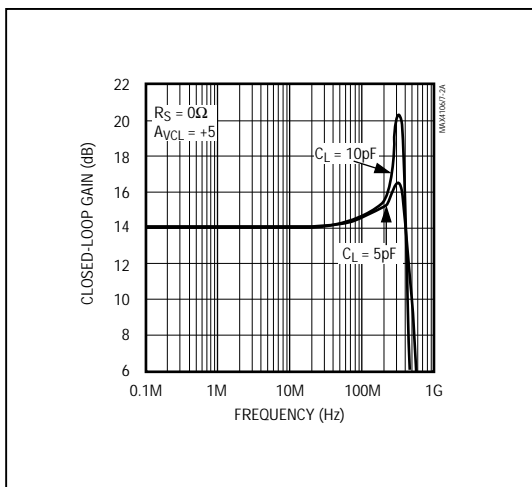

Figure 2a. MAX4106 Response vs. Capacitive Load—No Resistive (R_S) Isolation (circuit shown in Figure 1)

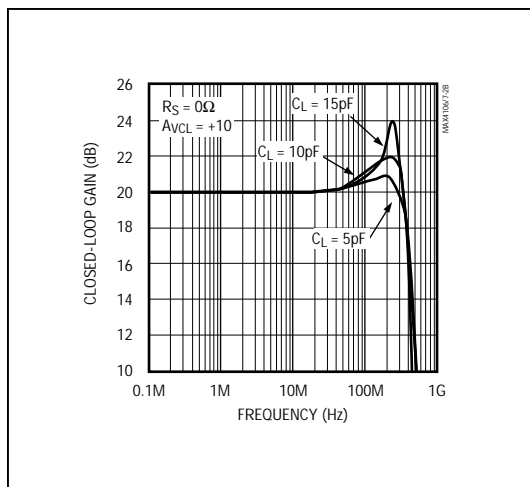

Figure 2b. MAX4107 Response vs. Capacitive Load—No Isolation (R_S) Resistor (circuit shown in Figure 1)

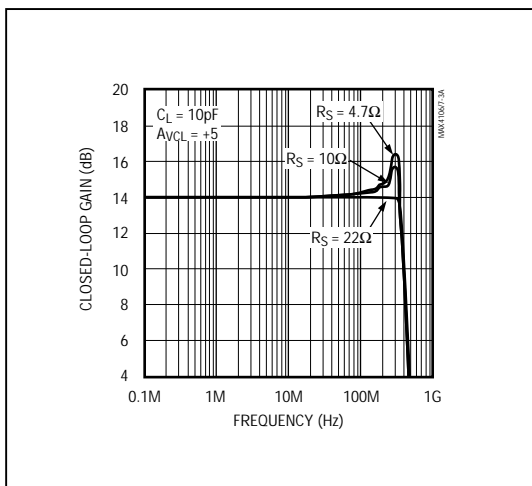

Figure 3a. MAX4106 Response vs. Capacitive Load with Resistive (R_S) Isolation (circuit shown in Figure 1)

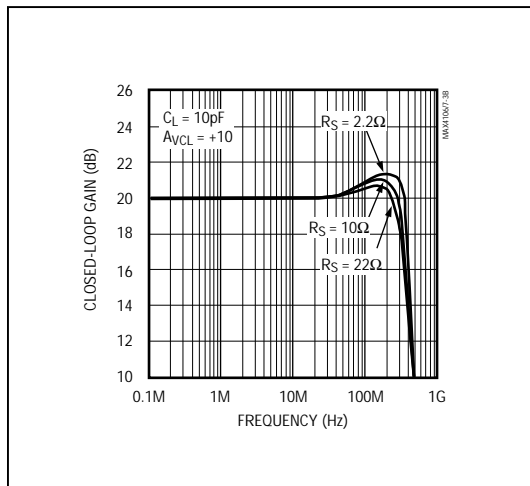

Figure 3b. MAX4107 Response vs. Capacitive Load with Resistive (R_S) Isolation (circuit shown in Figure 1)

350MHz, Ultra-Low-Noise Op Amps

Chip Information

TRANSISTOR COUNT: 55

Package Information

DIM	INCHES		MILLIMETERS	
	MIN	MAX	MIN	MAX
A	0.053	0.069	1.35	1.75
A1	0.004	0.010	0.10	0.25
B	0.014	0.019	0.35	0.49
C	0.007	0.010	0.19	0.25
E	0.150	0.157	3.80	4.00
e	0.050		1.27	
H	0.228	0.244	5.80	6.20
L	0.016	0.050	0.40	1.27

DIM	PINS	INCHES		MILLIMETERS	
		MIN	MAX	MIN	MAX
D	8	0.189	0.197	4.80	5.00
D	14	0.337	0.344	8.55	8.75
D	16	0.386	0.394	9.80	10.00

21-0041A

350MHz, Ultra-Low-Noise Op Amps

MAX4106/MAX4107

350MHz, Ultra-Low-Noise Op Amps

MAX4106/MAX4107

Maxim cannot assume responsibility for use of any circuitry other than circuitry entirely embodied in a Maxim product. No circuit patent licenses are implied. Maxim reserves the right to change the circuitry and specifications without notice at any time.

12 _____ Maxim Integrated Products, 120 San Gabriel Drive, Sunnyvale, CA 94086 (408) 737-7600

© 1995 Maxim Integrated Products

Printed USA

MAXIM is a registered trademark of Maxim Integrated Products.

www.BDTIC.com/maxim