

Not Recommended for New Designs

This product was manufactured for Maxim by an outside wafer foundry using a process that is no longer available. It is not recommended for new designs. The data sheet remains available for existing users.

A Maxim replacement or an industry second-source may be available. Please see the QuickView data sheet for this part or contact technical support for assistance.

For further information, [contact Maxim's Applications Tech Support](#).

MAXIM

Low Noise, High-Precision Op Amps

General Description

The MAX427/MAX437 $\pm 15\text{V}$ operational amplifiers feature a superior combination of low wideband noise, and ultra-low offset voltage and drift; $2.5\text{nV}/\sqrt{\text{Hz}}$ (1kHz) noise, less than $15\mu\text{V}$ offset voltage ($5\mu\text{V}$ typ), and less than $0.8\mu\text{V}/^\circ\text{C}$ drift ($0.1\mu\text{V}/^\circ\text{C}$ typ). Voltage gain is 20 million when driving a $2\text{k}\Omega$ load to $\pm 12\text{V}$, and 12 million with a 600Ω load to $\pm 10\text{V}$.

The MAX427 is unity-gain stable, with an 8MHz gain bandwidth and a $2.5\text{V}/\mu\text{s}$ slew rate. The decompensated MAX437 has a 60MHz gain bandwidth, a $15\text{V}/\mu\text{s}$ slew rate, and is stable for closed-loop gains of 5 or greater.

For applications requiring even lower noise and low-power performance from $\pm 5\text{V}$ supplies, see the MAX410/MAX412/MAX414 data sheet.

Applications

Low-Noise Signal Processing
Threshold Detection
Strain-Gauge Amplifiers
Microphone Preamplifiers

Typical Application Circuit

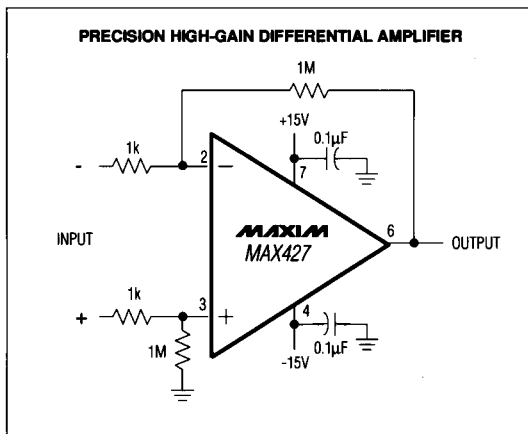

Features

- ◆ **15 μV Max Offset Voltage**
- ◆ **0.8 $\mu\text{V}/^\circ\text{C}$ Max Drift**
- ◆ **Low Noise Performance:**
4.5nV/ $\sqrt{\text{Hz}}$ Max (10Hz)
3.8nV/ $\sqrt{\text{Hz}}$ Max (1kHz)
- ◆ **High-Voltage Gain:**
7 Million Min (2k Ω Load)
3 Million Min (600 Ω Load)
- ◆ **117dB Min CMRR**
- ◆ **60MHz Gain-Bandwidth Product (MAX437)**

Ordering Information

PART	TEMP. RANGE	PIN-PACKAGE
MAX427CPA	0°C to +70°C	8 Plastic DIP
MAX427CSA	0°C to +70°C	8 SO
MAX427C/D	0°C to +70°C	Dice*
MAX427EPA	-40°C to +85°C	8 Plastic DIP
MAX427ESA	-40°C to +85°C	8 SO
MAX427MJA	-55°C to +125°C	8 CERDIP**
MAX437CPA	0°C to +70°C	8 Plastic DIP
MAX437CSA	0°C to +70°C	8 SO
MAX437C/D	0°C to +70°C	Dice*
MAX437EPA	-40°C to +85°C	8 Plastic DIP
MAX437ESA	-40°C to +85°C	8 SO
MAX437MJA	-55°C to +125°C	8 CERDIP**

* Dice are specified at $T_A = +25^\circ\text{C}$, DC parameters only.

**Contact factory for availability and processing to MIL-STD-883.

Pin Configuration

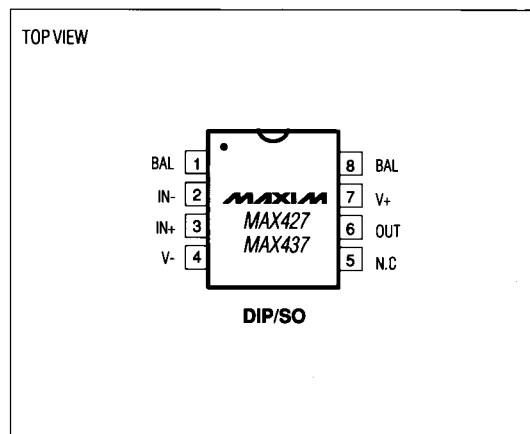

MAXIM

Maxim Integrated Products 1

For free samples & the latest literature: <http://www.maxim-ic.com>, or phone 1-800-998-8800

MAX427/MAX437

Ultra-Low Noise, High-Precision Op Amps

ABSOLUTE MAXIMUM RATINGS

Supply Voltage	±22V
Input Voltage (Note 1)	±22V
Output Short-Circuit Duration	Continuous
Differential Input Voltage (Note 2)	±0.7V
Differential Input Current (Note 2)	±25mA
Continuous Power Dissipation (T _A = +70°C)	
Plastic DIP (derate 9.09mW/°C above +70°C)	727mW
SO (derate 5.88mW/°C above +70°C)	471mW
CERDIP (derate 8.00mW/°C above +70°C)	640mW

Operating Temperature Ranges:

MAX427/MAX437C_A	0°C to +70°C
MAX427/MAX437E_A	-40°C to +85°C
MAX427/MAX437MJA	-55°C to +125°C
Junction Temperature Range	-65°C to +150°C
Storage Temperature Range	-65°C to +150°C
Lead Temperature (soldering, 10 sec)	+300°C

Note 1: For supply voltages less than ±22V, the absolute maximum input voltage is equal to the supply voltage.

Note 2: MAX427/MAX437 inputs are protected by back-to-back diodes. Current-limiting resistors are not used in order to achieve low noise. If differential input voltage exceeds ±0.7V, the input current should be limited to 25mA.

Stresses beyond those listed under "Absolute Maximum Ratings" may cause permanent damage to the device. These are stress ratings only, and functional operation of the device at these or any other conditions beyond those indicated in the operational sections of the specifications is not implied. Exposure to absolute maximum rating conditions for extended periods may affect device reliability.

ELECTRICAL CHARACTERISTICS

(V_S = ±15V, T_A = +25°C, unless otherwise noted.)

PARAMETER	SYMBOL	CONDITIONS	MIN	TYP	MAX	UNITS
Input Offset Voltage (Note 3)	V _{OS}			5	15	μV
Long-Term V _{OS} Stability (Notes 4, 5)	V _{OS} /TIME			0.2	1.0	μV/Mo
Input Bias Current	I _B			±10	±35	nA
Input Offset Current	I _{OS}			7	30	nA
Input Voltage Range	I _{VR}		±11.0	±12.5		V
Input Resistance – Common Mode	R _{INCM}			7		GΩ
Input Noise Voltage (Notes 5, 6)	e _{np-p}	0.1Hz to 10Hz		0.06	0.13	μV _{p-p}
Input Noise-Voltage Density (Note 5)	e _n	f _o = 10Hz		2.8	4.5	nV/√Hz
		f _o = 1kHz		2.5	3.8	
Input Noise-Current Density (Notes 5, 7)	i _n	f _o = 10Hz		1.5	4.0	pA/√Hz
		f _o = 1kHz		0.4	0.6	
Large-Signal Voltage Gain	A _{VO}	R _L ≥ 2kΩ, V _O = ±12V	7	20		V/μV
		R _L ≥ 1kΩ, V _O = ±10V	5	16		
		R _L ≥ 600Ω, V _O = ±10V	3	12		
Output Voltage Swing	V _O	R _L ≥ 2kΩ	±13.0	±13.8		V
		R _L ≥ 600Ω	±11.0	±12.5		
Open-Loop Output Resistance	R _O	V _O = 0, I _O = 0		70		Ω
Common-Mode Rejection Ratio	CMRR	V _{CM} = ±11V	117	130		dB
Power-Supply Rejection Ratio	PSRR	V _S = ±4V to ±18V	110	130		dB
Gain-Bandwidth Product (Note 5)	GBP	MAX427, f _o = 100kHz	5.0	8.0		MHz
		MAX437, f _o = 10kHz, A _{VCL} ≥ 5	45	60		
Slew Rate (Note 5)	SR	MAX427, R _L ≥ 2kΩ	1.7	2.8		V/μs
		MAX437, R _L ≥ 2kΩ, A _{VCL} ≥ 5	11	17		
Power Dissipation	PD	V _O = 0		80	120	mW
Offset Adjustment Range		R _P = 10kΩ		±4.0		mV

Low Noise, High-Precision Op Amps

MAX427/MAX437

ELECTRICAL CHARACTERISTICS

($V_S = \pm 15V$, $T_A = T_{MIN}$ to T_{MAX} , unless otherwise noted.)

PARAMETER	SYMBOL	CONDITIONS	MIN	TYP	MAX	UNITS
Input Offset Voltage (Note 3)	V_{OS}			20	50	μV
Average Offset-Voltage Drift (Notes 5, 8)	TCV_{OS}			0.1	0.8	$\mu V/^{\circ}C$
Input Bias Current	I_B			± 20	± 60	nA
Input Offset Current	I_{OS}			15	50	nA
Input Voltage Range	I_{VR}	MAX4_7C/E	± 10.5	± 11.8		V
		MAX4_7M	± 10.3	± 11.5		
Large-Signal Voltage Gain	A_{VO}	$R_L \geq 2k\Omega$, $V_O = \pm 10V$	3.0	14.0		V/ μV
		$R_L \geq 1k\Omega$, $V_O = \pm 10V$	2.0	10.0		
Maximum Output-Voltage Swing	V_O	$R_L \geq 2k\Omega$	± 12.5	± 13.5		V
Common-Mode Rejection Ratio	CMRR	$V_{CM} = \pm 10V$	112	126		dB
Power-Supply Rejection Ratio	PSRR	$V_S = \pm 4.5V$ to $\pm 18V$	104	126		dB
Power Dissipation	PD			100	150	mW

Note 3: Input Offset Voltage measurements are performed by automatic test equipment approximately 0.5 sec after application of power.

Note 4: Long-Term Input Offset Voltage Stability refers to the average trend line of Offset Voltage vs. Time over extended periods after the first 30 days of operation. Excluding the initial hour of operation, changes in V_{OS} during the first 30 days are typically $2.5\mu V$ – refer to typical performance curve.

Note 5: Guaranteed by design.

Note 6: See the test circuit and frequency response curve for 0.1Hz to 10Hz tester in the *Applications Information* section.

Note 7: See the test circuit for current noise measurement in the *Applications Information* section.

Note 8: The average input offset drift performance is within the specifications unnullled or when nullled with a pot having a range of $8k\Omega$ to $20k\Omega$. Contact factory for the availability of a higher-performance, 100% tested drift parameter of $0.4\mu V/^{\circ}C$ max.

Ultra-Low Noise, High-Precision Op Amps

Typical Operating Characteristics

(TA = +25°C, unless otherwise noted.)

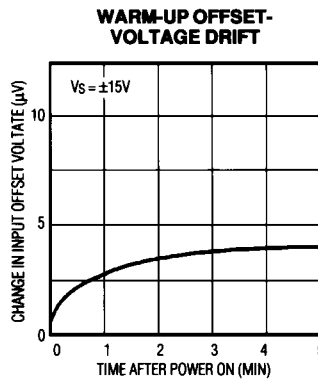
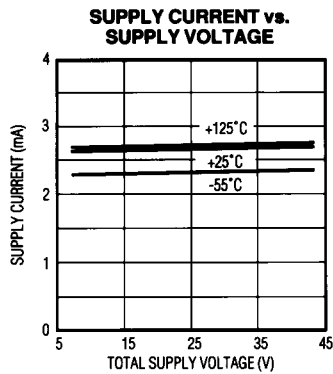
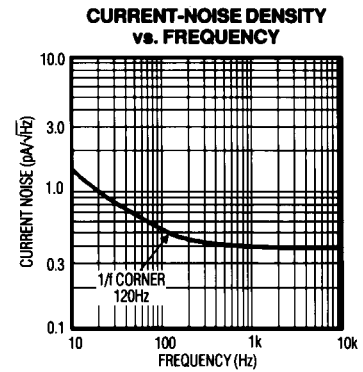
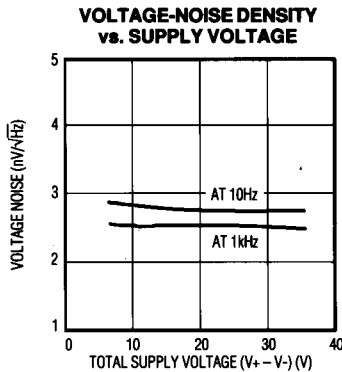
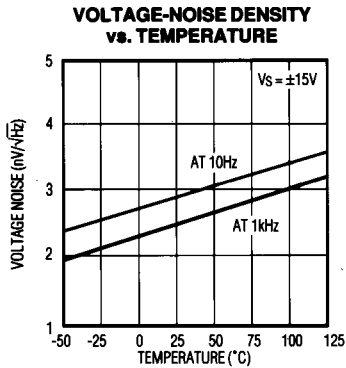
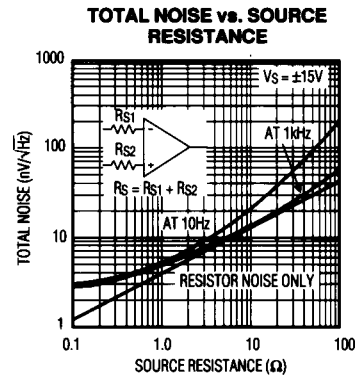
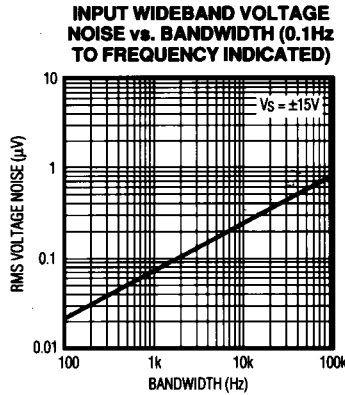
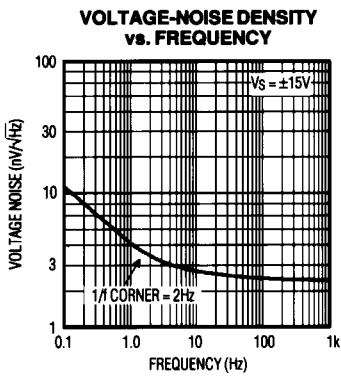

Low Noise, High-Precision Op Amps

Typical Operating Characteristics (continued)

(TA = +25°C, unless otherwise noted.)

MAX427/MAX437

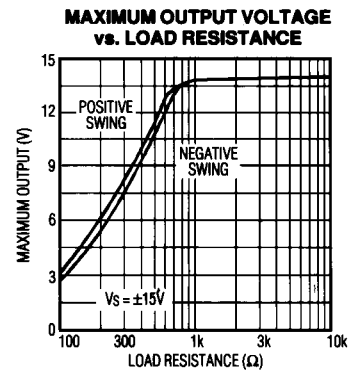
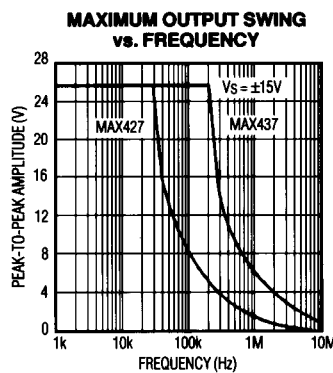
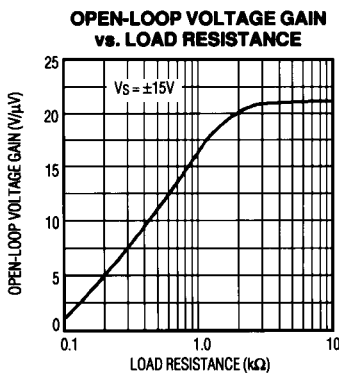
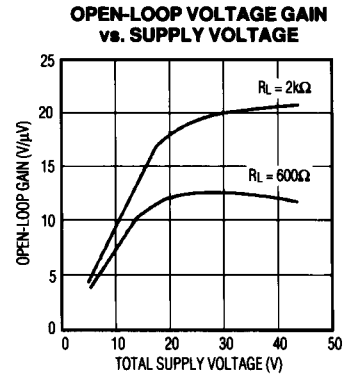
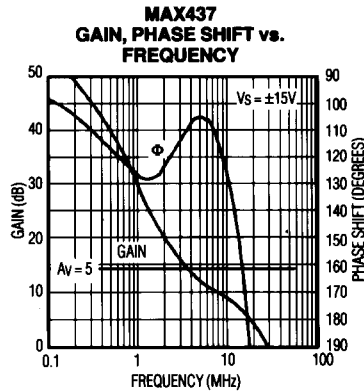
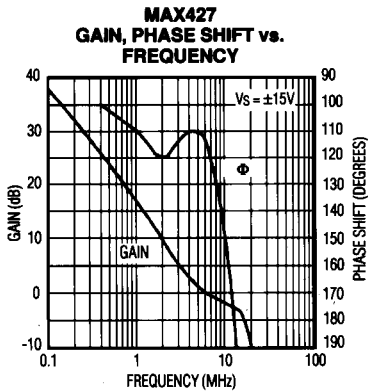
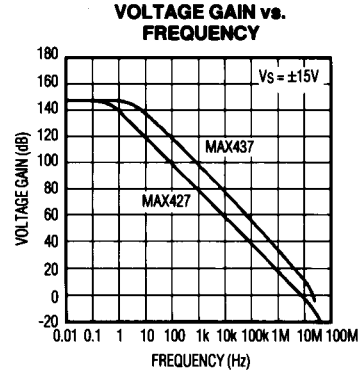
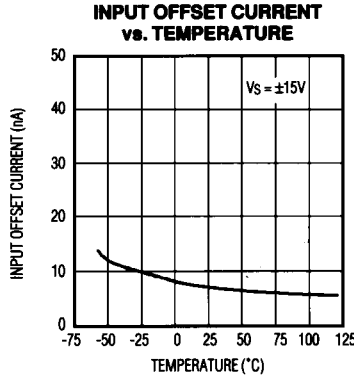
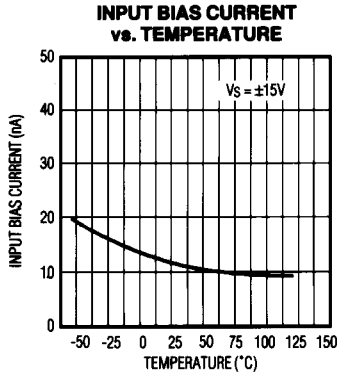

Ultra-Low Noise, High-Precision Op Amps

MAX427/MAX437

Typical Operating Characteristics (continued)

(TA = +25°C, unless otherwise noted.)

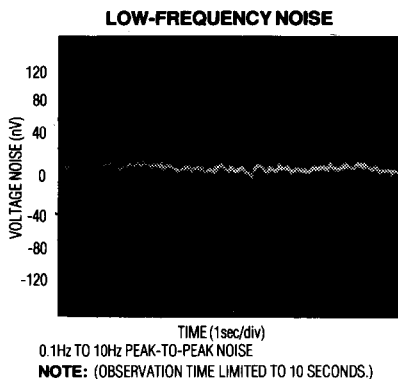
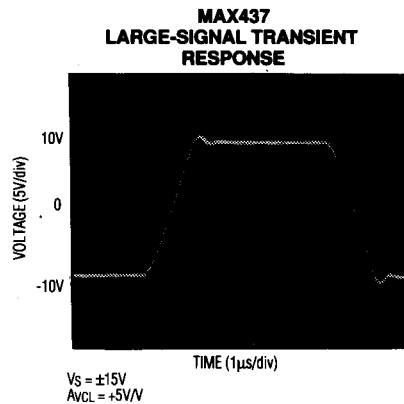
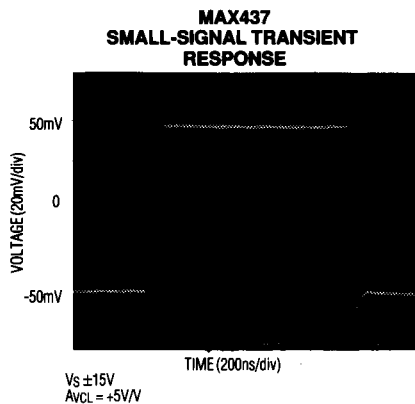
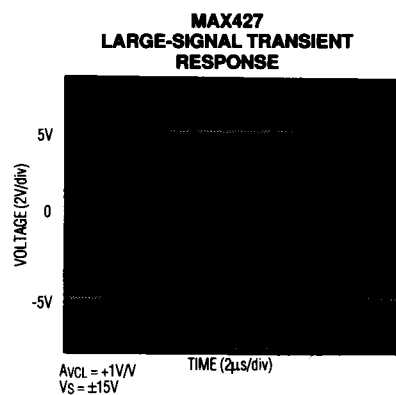
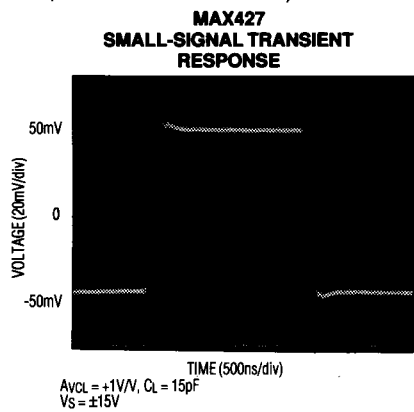

Low Noise, High-Precision Op Amps

MAX427/MAX437

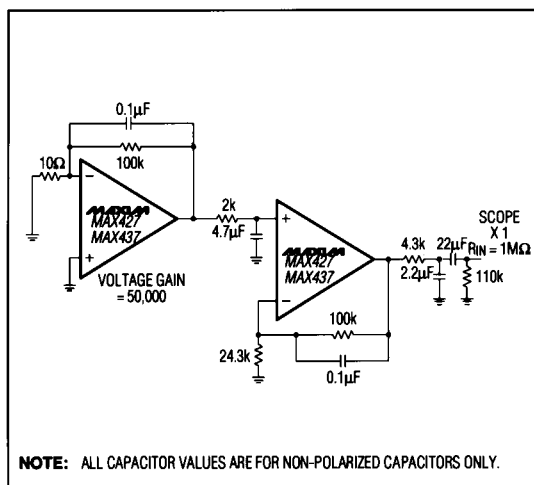

Figure 1. Voltage-Noise Test Circuit (0.1Hz to 10Hz)

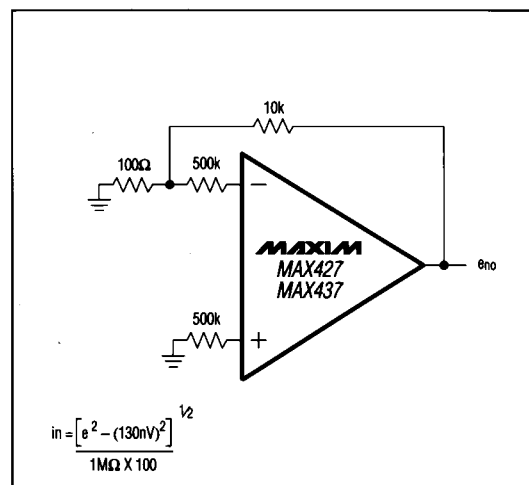

Figure 2. Current-Noise Test Circuit

Applications Information

The MAX427/MAX437 provide stable operation with load capacitances of up to 2nF and $\pm 10V$ output swings; larger capacitances should be decoupled with a 50 Ω series resistor inside the feedback loop. The MAX427 is unity-gain stable and the MAX437 is stable at gains of five or greater.

Thermoelectric voltages generated by dissimilar metals at the input terminals degrade the drift performance. Connections to both inputs should be maintained at the same temperature for best operation.

Offset-Voltage Adjustment

Input offset voltage (V_{OS}) is trimmed at the wafer level. If V_{OS} adjustment is necessary, a 10k Ω trim potentiometer (pot) may be used and will not degrade TCV_{OS} (Figure 3). Other trim pot values from 1k Ω to 1M Ω can be used with a slight degradation (0.1 $\mu V/^{\circ}C$ to 0.2 $\mu V/^{\circ}C$) of TCV_{OS} . Adjusting, but not zeroing, V_{OS} creates a drift of approximately $(V_{OS}/300)\mu V/^{\circ}C$. The adjustment range with a 10k Ω trim pot is $\pm 4mV$. For a smaller range, reduce nulling sensitivity by connecting a smaller pot in series with fixed resistors; for example, Figure 4 has a $\pm 70\mu V$ adjustment range.

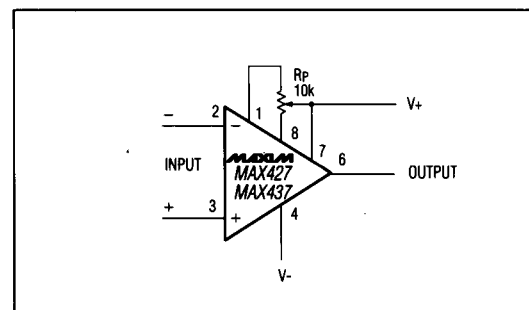

Figure 3. Offset Nulling Circuit

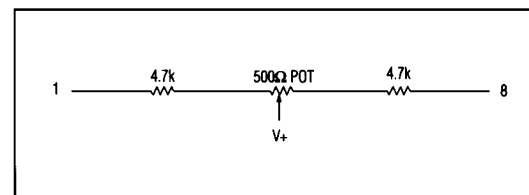

Figure 4. Alternate Offset-Voltage Adjustment

Ultra-Low Noise, High-Precision Op Amps

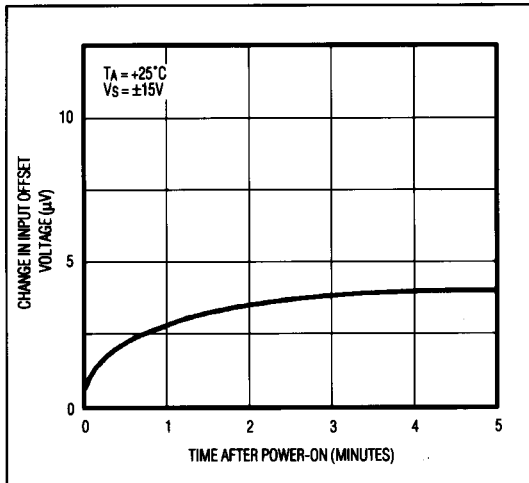

Figure 5. Warm-Up Offset Voltage Drift

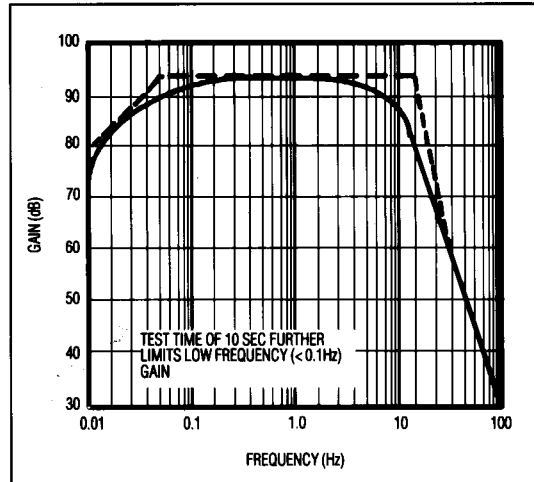

Figure 6. 0.1Hz to 10Hz V_{p-p} Noise Tester Frequency Response

Noise Measurements

To measure the $60nV_{p-p}$ noise specification of the MAX427/MAX437 in the 0.1Hz to 10Hz range, observe the following precautions:

1. The device must warm up for at least five minutes. Figure 5 shows how V_{OS} typically increases $4\mu V$ with increases in chip temperature after power-up. In the 10sec measurement interval, temperature-induced effects can exceed $10nV$.
2. For similar reasons, the device must be well-shielded from air currents, including those caused by motion. This minimizes thermocouple effects.
3. As shown in Figure 6, the 0.1Hz corner is defined by only one zero. A maximum test time of 10sec acts as an additional zero to eliminate noise contributions from the frequency band below 0.1Hz.
4. A noise-voltage-density test is recommended when measuring noise on a large number of units. A 10Hz noise-voltage-density measurement correlates well with a 0.1Hz to 10Hz peak-to-peak noise reading, since both results are determined by the white noise and the location of the $1/f$ corner frequency.

Unity-Gain Buffer Applications (MAX427 Only)

Figure 7 shows the circuit and output waveform with $R_f \leq 100\Omega$, and the input driven with a fast, large signal pulse ($>1V$).

During the fast rise portion of the output, the input protection diodes short the output to the input, and a current, limited only by the output short-circuit protection, is drawn by the signal generator. With $R_f \geq 500\Omega$, the output is capable of handling the current requirement ($I_L \leq 20mA$ at 10V) and a smooth transition occurs.

When $R_f \geq 2k\Omega$, a pole created with R_f and the amplifier's input capacitance ($8pF$) causes additional phase shift and reduces phase margin. A small capacitor ($20pF$ to $50pF$) in parallel with R_f eliminates this problem.

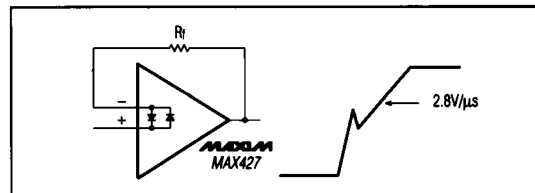

Figure 7. Pulsed Operation of Unity-Gain Buffer

Low Noise, High-Precision Op Amps

MAX427/MAX437

Comments on Noise

The MAX427/MAX437 are very low-noise amplifiers. They achieve outstanding input voltage noise characteristics by operating the input stage at a high quiescent current. Input bias and offset currents, which would normally increase with the quiescent current, are minimized by bias-current cancellation circuitry. The MAX427/MAX437 have I_B and I_{OS} of only $\pm 35\text{nA}$ and 30nA respectively at $+25^\circ\text{C}$. This is particularly important with high source-resistances.

Voltage noise is inversely proportional to the square-root of bias current, but current noise is proportional to the square-root of bias current. The MAX427/MAX437 low-noise advantages are reduced when high source resistors are used.

$$\text{Total noise} = [(\text{voltage noise})^2 + (\text{current noise} \times R_S)^2 + (\text{resistor noise})^2]^{1/2}$$

Figure 8 shows noise vs. source resistance at 1kHz. To use this plot for wideband noise, multiply the vertical scale by the square-root of the bandwidth. The MAX427/MAX437 maintain low input noise voltage with $R_S < 1\text{k}\Omega$. With $R_S > 1\text{k}\Omega$, total noise increases and is dominated by the resistor noise, not the current or the voltage noise. It is only with $R_S \geq 20\text{k}\Omega$ that current noise dominates. Current noise is not important for applications with $R_S < 20\text{k}\Omega$. The MAX427/MAX437 have lower total noise than the MAX400/OP07 for $R_S < 10\text{k}\Omega$. As R_S increases, the crossover between the MAX427/MAX437 and the MAX400/OP07 noise occurs in the $R_S = 15\text{k}\Omega$ to $40\text{k}\Omega$ region.

Figure 9 shows 0.1Hz to 10Hz peak-to-peak noise. Here, resistor noise is negligible and current noise (i_n) becomes important, because $i_n \propto 1/\sqrt{f}$. The crossover with the MAX400/OP07 occurs in the $R_S = 3\text{k}\Omega$ to $5\text{k}\Omega$ range, depending on whether balanced or unbalanced source resistors are used (at $3\text{k}\Omega$ the I_B and I_{OS} error can be three times the V_{OS} specification). For low-frequency applications, the MAX400/OP07 are better than the MAX427/MAX437 when $R_S > 3\text{k}\Omega$, except when gain error is important. Figure 10 illustrates the 10Hz noise. As expected, the results fall between those of the previous two figures.

For reference, typical source resistances of some signal sources are listed in Table 1.

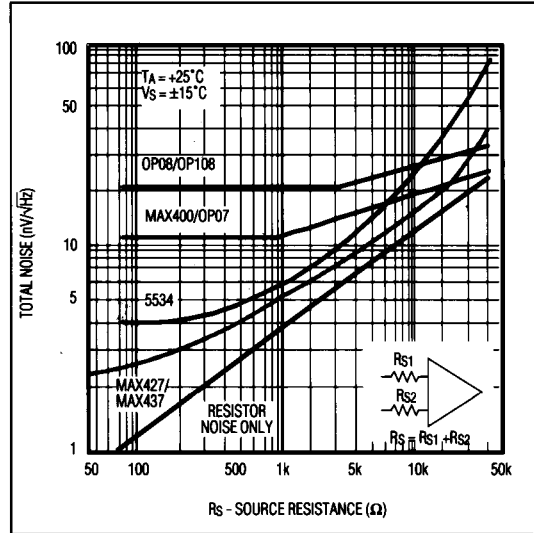

Figure 8. Noise vs. Source Resistance (Including Resistor Noise) at 1kHz

Table 1. Signal Source vs. Source Impedance

DEVICE	SOURCE IMPEDANCE	COMMENTS
Strain Gauge	$< 500\Omega$	Typically used in low-frequency applications.
Magnetic Tapehead	$< 1500\Omega$	Low I_B is very important to reduce self-magnetization problems when direct coupling is used. MAX427 I_B can be neglected.
Linear Variable Differential Transformer	$< 1500\Omega$	Used in rugged servo-feedback applications. Bandwidth of interest is 400Hz to 5kHz.

Ultra-Low Noise, High-Precision Op Amps

MAX427/MAX437

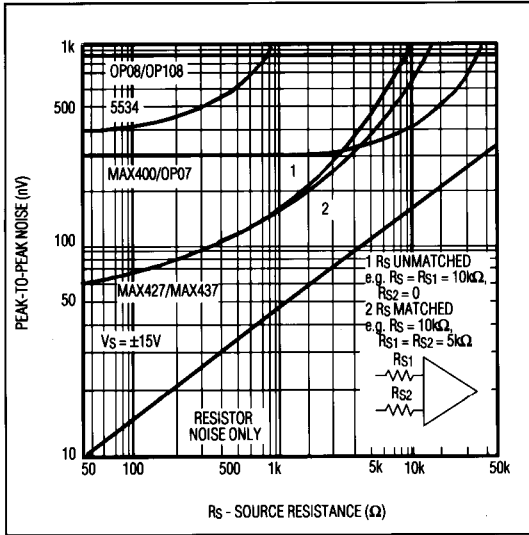

Figure 9. Peak-to-Peak Noise (0.1 to 10Hz) vs. Source Resistance (Includes Resistor Noise)

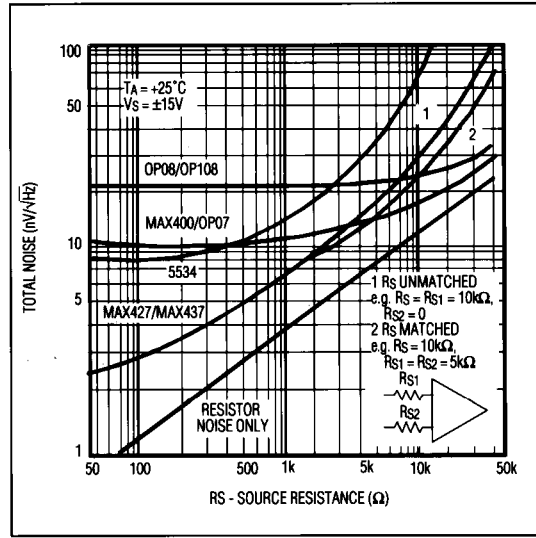
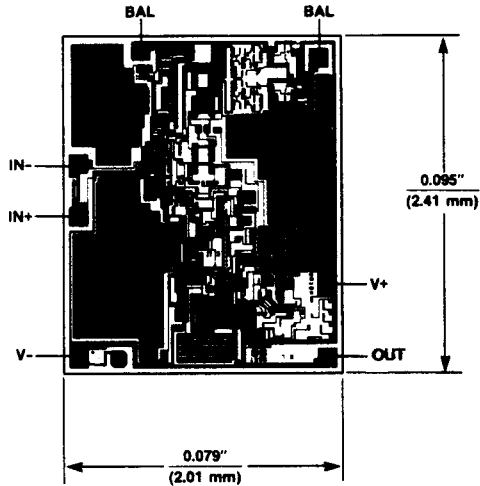

Figure 10. 10Hz Noise vs. Source Resistance (Includes Resistor Noise)

Low Noise, High-Precision Op Amps

MAX427/MAX437

Chip Topography



MAX427/MAX437

SUBSTRATE CONNECTED TO V-

Package Information

DIM	INCHES		MILLIMETERS	
	MIN	MAX	MIN	MAX
A	—	0.200	—	5.08
A1	0.015	—	0.38	—
A2	0.125	0.175	3.18	4.45
A3	0.055	0.080	1.40	2.03
B	0.016	0.022	0.41	0.56
B1	0.045	0.065	1.14	1.65
C	0.008	0.012	0.20	0.30
D1	0.005	0.080	0.13	2.03
E	0.300	0.325	7.62	8.26
E1	0.240	0.310	6.10	7.87
e	0.100	—	2.54	—
eA	0.300	—	7.62	—
eB	—	0.400	—	10.16
L	0.115	0.150	2.92	3.81

PKG.	DIM	PINS	INCHES		MILLIMETERS	
			MIN	MAX	MIN	MAX
P	D	8	0.348	0.390	8.84	9.91
P	D	14	0.735	0.765	18.67	19.43
P	D	16	0.745	0.765	18.92	19.43
P	D	18	0.885	0.915	22.48	23.24
P	D	20	1.015	1.045	25.78	26.54
N	D	24	1.14	1.265	28.96	32.13

21-0043A

Ultra-Low Noise, High-Precision Op Amps

Package Information (continued)

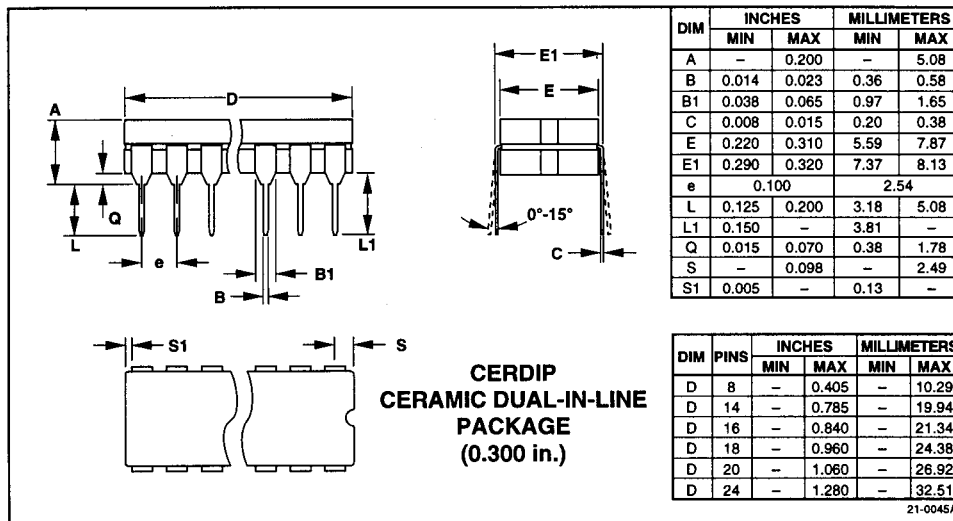
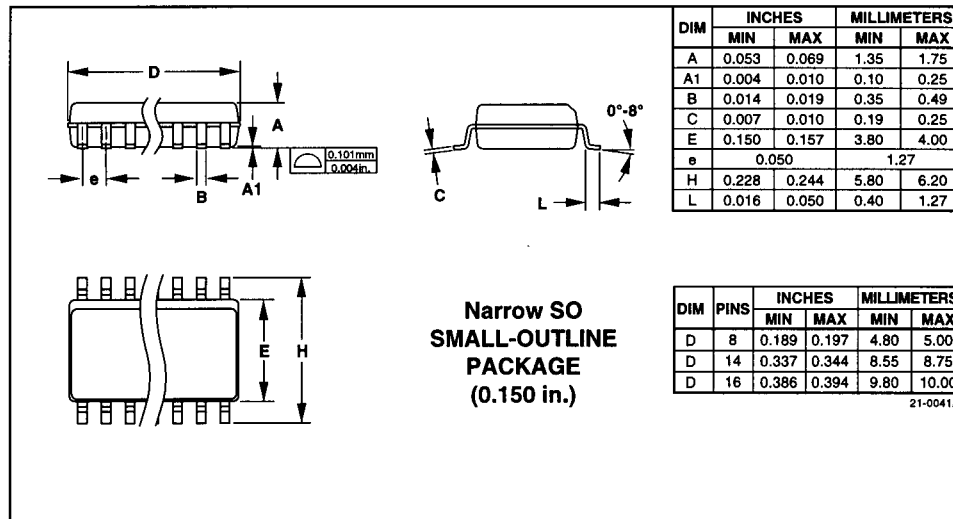

Maxim cannot assume responsibility for use of any circuitry other than circuitry entirely embodied in a Maxim product. No circuit patent licenses are implied. Maxim reserves the right to change the circuitry and specifications without notice at any time.

12 **Maxim Integrated Products, 120 San Gabriel Drive, Sunnyvale, CA 94086 (408) 737-7600**

© 1992 Maxim Integrated Products

Printed USA

MAXIM is a registered trademark of Maxim Integrated Products.