

### FEATURES

- 2A, 0.2Ω, internal switch
- Operating voltage as low as 2.7V
- 600 kHz operation frequency
- Over temperature protection
- 8-Lead SOIC-EDP package

### APPLICATIONS

- LCD TVs and LCD monitors
- Battery Chargers
- Portable (Notebook) Computers
- Handheld Devices
- Portable Applications
- Consumer Electronics
- GSM/CDMA Phones
- Digital Cameras

### GENERAL DESCRIPTION

The AMS6101 is an adjustable step-up DC/DC converter with a 2A internal switch. With the ability to set the output voltage up to 23V, the AMS6101 is an ideal part for biasing TFT displays. The AMS6101 can be operated at switching frequencies of 600 kHz allowing for easy filtering and low noise. An external compensation pin gives the user flexibility in setting frequency compensation, which makes possible the use of small, low ESR ceramic capacitors at the output. The AMS6101 is available in a low profile 8-lead SOIC EDP (thermally enhanced) package.

### ORDERING INFORMATION

OUTPUT	PACKAGE TYPE	TEMP.
VOLTAGE	8 Lead SOIC	RANGE
Adjustable	AMS6101S	-25°C to 125°C

### PIN CONNECTIONS

#### 8L SOIC SO Package (S)

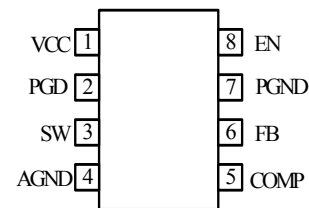

Top View

### TYPICAL APPLICATION

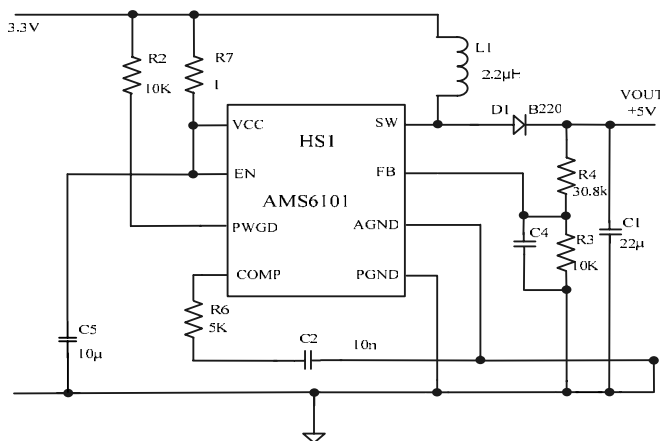

## PIN DESCRIPTION

AMS6101		
PIN NUMBERS	NAME	DESCRIPTION
1	VCC	Analog power input.
2	PWGD	Power good output. Open collector output. A low on the pin indicates that the output is less than the desired output voltage. There is an internal rising filter on the output of the PWGD comparator.
3	SW	Power switch input. Internal switch connected between SW pin and GND pin.
4	AGND	Analog ground.
5	COMP	Compensation network connection. Connected to the output of the voltage error amplifier.
6	F/B	Feedback input pin of the error comparator.
7	PGND	Power Ground-Noisy internal ground-Return currents from the power switch (SW).
8	EN	Shutdown control input, active high.

## ABSOLUTE MAXIMUM RATINGS (note 1)

VCC	15V	Maximum Junction Temperature	150°C
SW Voltage	23V	Power Dissipation (Note2)	Internally Limited
F/B Voltage	7V	Lead Temperature	300°C
Comp	7V	Vapor Phase (60 sec)	215°C
EN	7V	Infrared (15 sec)	220°C
PWGD	15V	ESD Susceptibility	2kV

## ELECTRICAL CHARACTERISTICS

Electrical Characteristics at  $T_A = 25^\circ\text{C}$ ,  $V_{IN} = 2.7\text{V}$ ,  $I_L = 0\text{A}$  (unless otherwise noted)

PARAMETER	TEST CONDITIONS	AMS6101			Units
		Min. (Note3)	Typ. (Note4)	Max. (Note3)	
Quiescent Current	FB = 0V (Not Switching) V EN = 0V		1.3 5	<b>2.0</b> <b>10</b>	mA $\mu\text{A}$
Feedback Voltage		<b>1.2285</b>	1.26	<b>1.2915</b>	V
Switch Current Limit	$V_{IN} = 2.7$ (Note 5)	3	4		A
Load Regulation	$V_{IN} = 3.3\text{V}$		6.7		mV/mA
Feedback Voltage Line Regulation	$2.0\text{V} \leq V_{IN} \leq 12.0\text{V}$		0.013	0.1	%V
FB Pin Bias Current			0.5	<b>20</b>	nA
Input Voltage Range		2.5		15	V
Error Amp Transconductance	$\Delta I = 5\mu\text{A}$	<b>40</b>	135	<b>290</b>	$\mu\text{mho}$
Error Amp Voltage Gain			135		V/V
Maximum Duty Cycle		<b>78</b>	85		%
Switching Frequency		<b>480</b>	600	<b>720</b>	kHz
Shutdown Pin Current	V EN = $V_{IN}$ V EN = 0V		0.01 -0.5	0.1 -1	$\mu\text{A}$
Switch Leakage Current	V SW = 18V		0.01	<b>3</b>	$\mu\text{A}$
Switch $R_{\text{DS(on)}}$	$V_{IN} = 2.7\text{V}$ , $I_{\text{SW}} = 1\text{A}$		0.2	<b>0.4</b>	$\Omega$
Enable Threshold	Output High Output Low	<b>0.9</b>	0.6 0.6	<b>0.3</b>	V V
On Threshold		<b>1.8</b>	1.92	<b>2.0</b>	V
Off Threshold		<b>1.7</b>	1.82	<b>1.9</b>	V
Thermal Resistance	Junction to Ambient		195		

### Note:

- 1). Absolute maximum ratings are limits beyond which damage to the device may occur. Operating Ratings are conditions for which the device is intended to be functional.
- 2). The maximum allowable power dissipation is a function of the maximum junction temperature,  $T_{J(\text{MAX})}$ , the junction-to-ambient thermal resistance,  $\theta_{JA}$ , and the ambient temperature,  $T_A$ . The maximum allowable power dissipation at any ambient temperature is calculated using:  $P_D(\text{MAX}) = (T_{J(\text{MAX})} - T_A) \theta_{JA}$ . Exceeding the maximum allowable power dissipation will cause excessive die temperature, and the regulator will go into thermal shutdown.
- 3). All limits guaranteed at room temperature (standard typeface) and at temperature extremes (bold typeface).
- 4). Typical numbers are at  $25^\circ\text{C}$  and represent the most likely norm.
- 5). Current limit at 0% duty cycle.

## TYPICAL PERFORMANCE CHARACTERISTICS

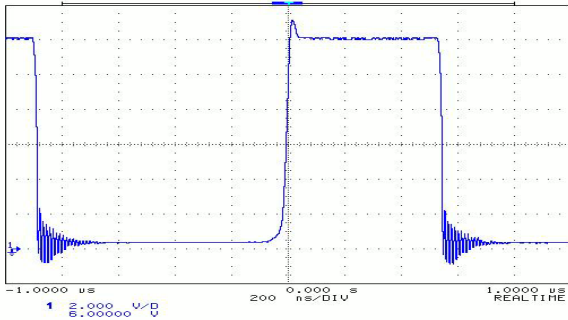

Full Load Switching

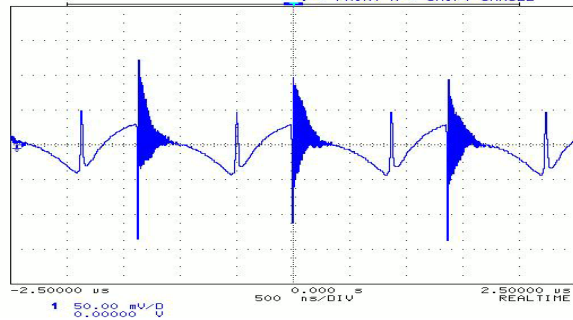

Full Load Ripple (Wide Band)

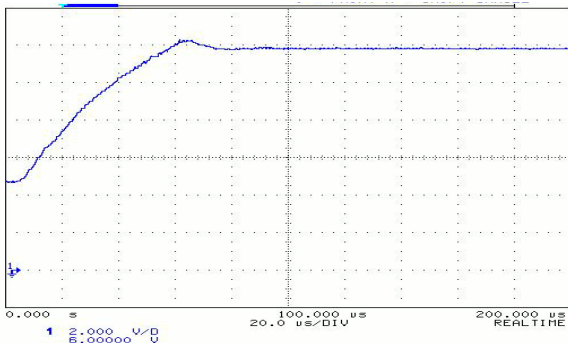

Start Up from Enable into Full Load

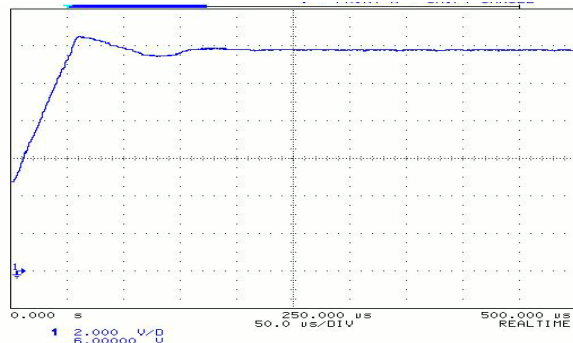

Start Up from Enable into Light Load

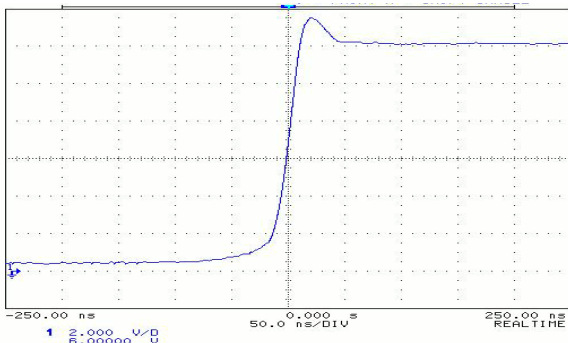

Switch Full Load Rise Time

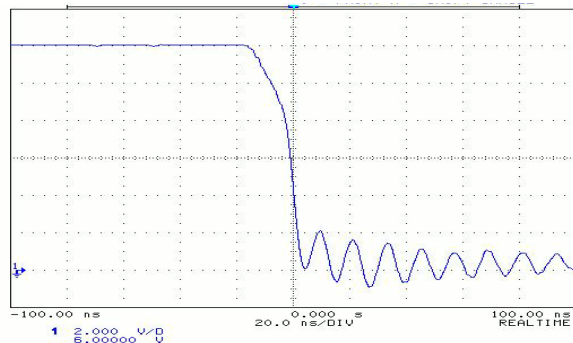

Switch Full Load Fall Time

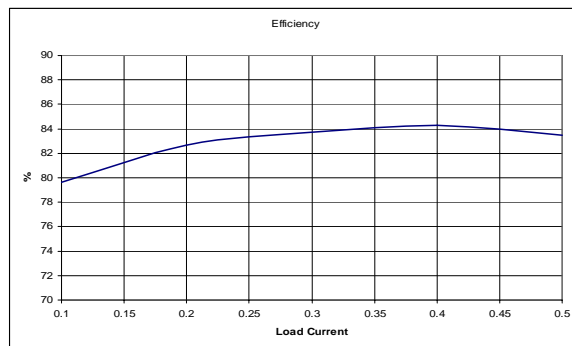

Efficiency for 5V input and 12V Output

**PACKAGE DIMENSIONS** inches (millimeters) unless otherwise noted.

## 8 LEAD SOIC PLASTIC PACKAGE (S)

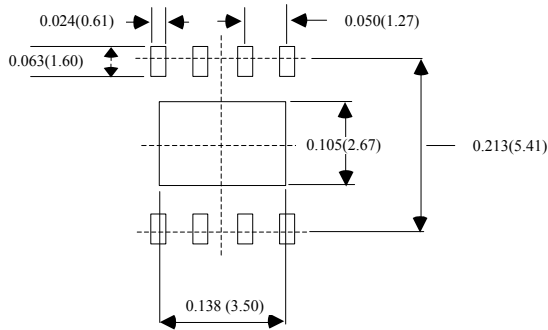
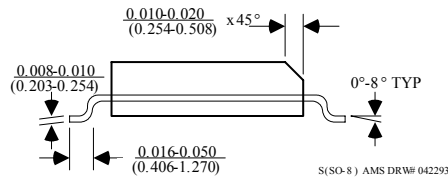
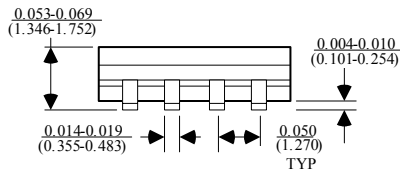
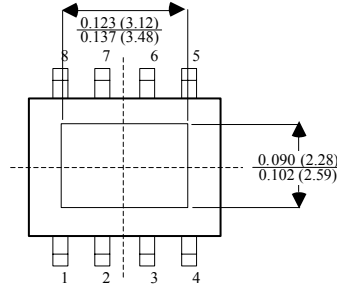
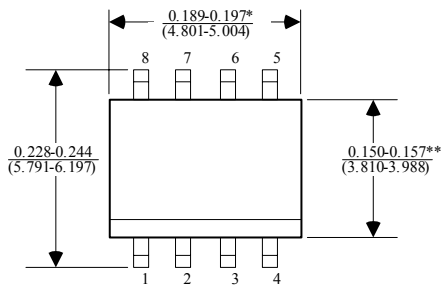

RECOMMENDED LAYOUT PATTERN

\*DIMENSION DOES NOT INCLUDE MOLD FLASH. MOLD FLASH SHALL NOT EXCEED 0.006" (0.152mm) PER SIDE

\*\*DIMENSION DOES NOT INCLUDE INTERLEAD FLASH. INTERLEAD FLASH SHALL NOT EXCEED 0.010" (0.254mm) PER SIDE