

600mA Low Noise High PSRR Low Dropout Linear Regulator

DESCRIPTION

The EUP7907A is a high current, low dropout linear regulator with fast transient response and high PSRR. It offers high output accuracy, extremely low dropout voltage, low quiescent current and fast start-up time.

The EUP7907A is designed to work with low-ESR ceramic capacitor, reducing the amount of the PCB area necessary for power applications. Only a 2.2uF ceramic capacitor can make the device stable over the whole load range.

The EUP7907A monitors the input voltage for power on reset to ensure the regulator is disabled when the input voltage is not high enough for normal operation. When EUP7907A detects fault signal, such as over-temperature, it will turn off the pass transistor and discharge VOUT to GND from the internal resistor.

EUP7907A only can be operated in fixed mode, the pre-set value is from 1.2V~3.6V. By setting the capacitor connected to BYPASS pin can get high PSRR. Other key features include over-current protection, thermal shutdown. The device can be available in the TDFN-6 and SOT23-5 package.

FEATURES

- 2.5V to 5.5V Input Voltage Range
- 300mV@600mA Dropout Voltage
- Excellent Transient Response
- Stable with 2.2uF Ceramic Output Capacitor
- 70dB PSRR at 1kHz
- Low 120uA Quiescent Current
- Low Shutdown Current:<1uA
- Output Current Limit
- Output Voltage With High Accuracy:
2% Initial Accuracy
Fixed Output Voltage: 1.2V ~ 3.6V
- Thermal Shutdown
- COUT Auto-Discharge when Shutdown
- RoHS Compliant and 100% Lead (Pb)-Free

APPLICATIONS

- Cellular Phones
- Bluetooth portable radios and Accessories
- battery-Powered Equipment
- Laptop, Palmtops, Notebook Compute

Typical Application Circuit

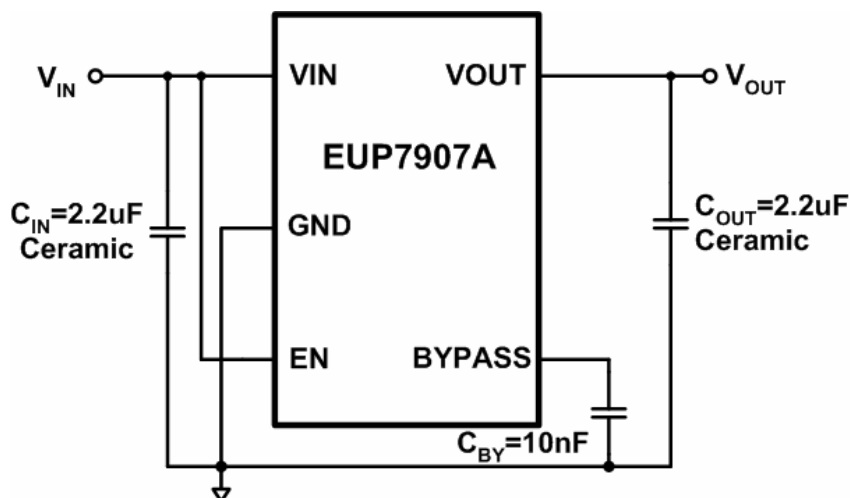

Figure. 1 Fixed Output

Block Diagram

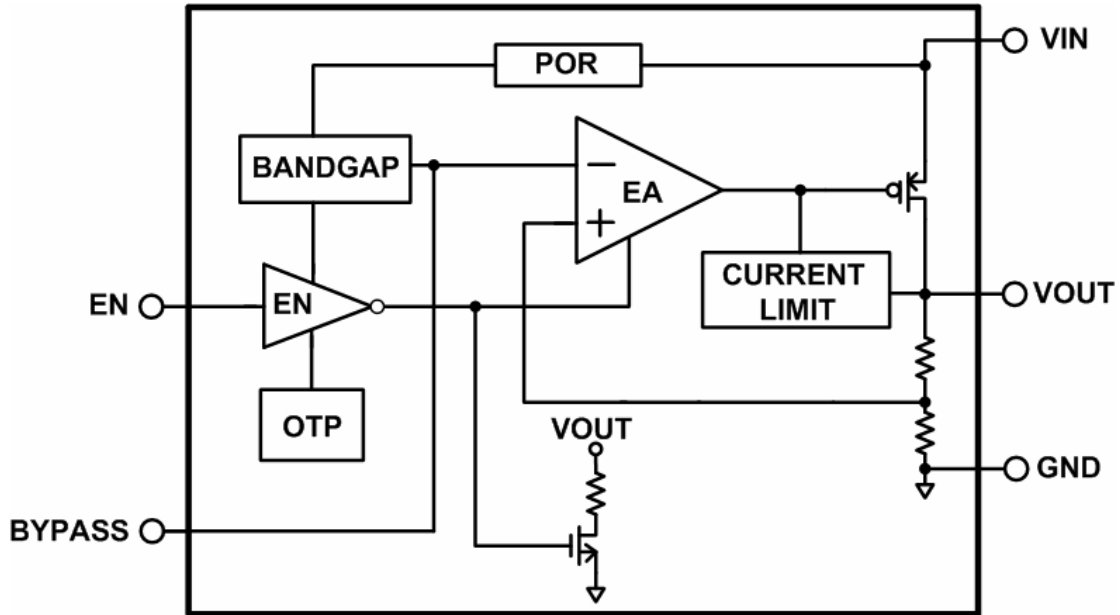

Figure. 2

Pin Configurations

Package Type	Pin Configurations	Package Type	Pin Configurations
SOT23-5		TDFN-6	

Pin Description

PIN	SOT23-5	TDFN-6	DESCRIPTION
VIN	1	3	Input Voltage of the LDO.
GND	2	2	Signal Ground.
EN	3	1	Enable Pin. Connect this pin to ground or less than 0.4V to disable the device. High-Z for EUP7907A.
BYPASS	4	6	Optional bypass capacitor for low noise and high PSRR.
VOUT	5	4	Output voltage of the LDO.
NC	-	5	No connected.

Ordering Information

Order Number	Package Type	Marking	Operating Temperature Range
EUP7907A-12VIR1	SOT23-5	XXXXX AA1T	-40 °C to +85°C
EUP7907A-15VIR1	SOT23-5	XXXXX AA1C	-40 °C to +85°C
EUP7907A-18VIR1	SOT23-5	XXXXX AA1D	-40 °C to +85°C
EUP7907A-25VIR1	SOT23-5	XXXXX AA1B	-40 °C to +85°C
EUP7907A-28VIR1	SOT23-5	XXXXX AA1E	-40 °C to +85°C
EUP7907A-33VIR1	SOT23-5	XXXXX AA1H	-40 °C to +85°C
EUP7907A-XXVIR1	SOT23-5	XXXXX XXXX	-40 °C to +85°C
EUP7907A-12JIR1	TDFN-6	XXX AT	-40 °C to +85°C
EUP7907A-15JIR1	TDFN-6	XXX AC	-40 °C to +85°C
EUP7907A-18JIR1	TDFN-6	XXX AD	-40 °C to +85°C
EUP7907A-25JIR1	TDFN-6	XXX AB	-40 °C to +85°C
EUP7907A-28JIR1	TDFN-6	XXX AE	-40 °C to +85°C
EUP7907A-33JIR1	TDFN-6	XXX AH	-40 °C to +85°C
EUP7907A-XXJIR1	TDFN-6	XXX XX	-40 °C to +85°C

EUP7907A -

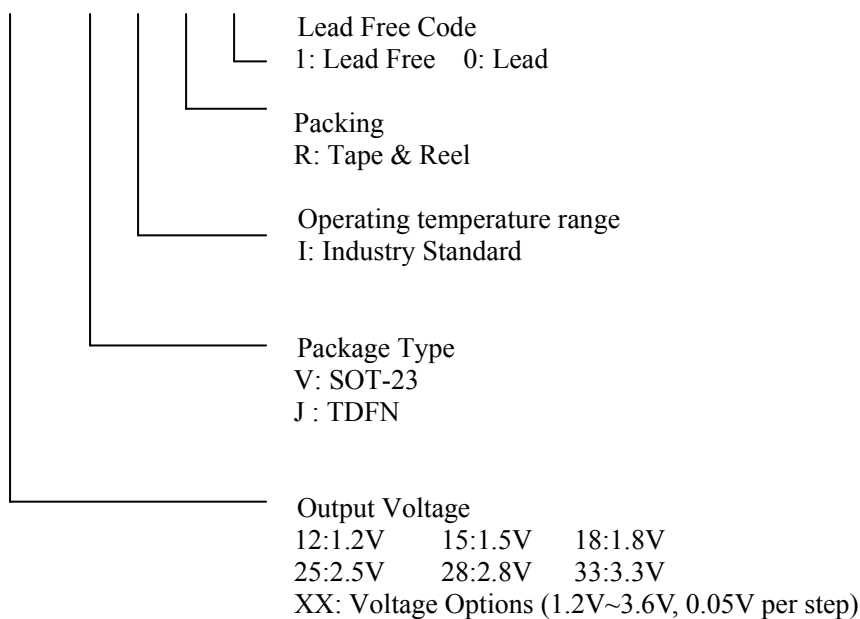

Absolute Maximum Ratings

■	V_{IN}, V_{EN}	-0.3 to 6V
■	V_{OUT}	-0.3 to (VIN+0.3)
■	Junction Temperature	150
■	Storage Temperature Range	-65 to +150
■	Lead Temperature	260
■	Thermal Resistance θ_{JA} (SOT23-5)	220 /W
■	Thermal Resistance θ_{JA} (TDFN-6)	90 /W
■	ESD Rating	
	Human Body Model	2kV

Recommend Operating Conditions

■	V_{IN}	2.5 to 5.5V
■	V_{EN}	0 to 5.5V
■	Operating Temperature Range	-40 to +85

Electrical Characteristics

$T_A=+25$, $V_{IN}=V_{OUT}+1V$, or $V_{IN}=2.5V$ for $V_{OUT}<1.5V$ unless otherwise specified

Symbol	Parameter	Conditions	EUP7907A			Unit
			Min.	Typ.	Max.	
Input Voltage						
V_{IN}	Input Voltage		2.5		5.5	V
V_{PORTH}	POR Threshold			2.1		V
V_{PORHYS}	POR hysteresis			0.4		V
I_Q	Quiescent Current	$V_{EN}=V_{IN}, I_{OUT}=0mA$		120	180	μA
I_{SHDN}	Shutdown Current	$V_{EN}=0V$		0.1	1	μA
PSRR	Power Supply Ripple Rejection	$V_{IN}=V_{NOM}+1V_{P-P}, f=1kHz, I_{LOAD}=10mA$		70		dB
		$V_{IN}=V_{NOM}+1V_{P-P}, f=10kHz, I_{LOAD}=10mA$		70		
V_{FB}	FB Pin Voltage		0.784	0.8	0.816	V
Enable						
V_{ENH}	Enable High Voltage	Over temperature range	1.5			V
V_{ENL}	Disable Low Voltage	Over temperature range			0.4	V
I_{EN}	EN Input Current	$V_{IN}=5V, V_{EN}=5V$ or $0V$	-1		1	μA
T_{ST}	Start-up Time	$C_{BYPASS}=10nF$		120		μs
Output voltage						
V_{OUT}	Output Voltage Accuracy	$V_{IN}=V_{NOM}+1.0V, I_{OUT}=10mA$	-2		+2	%
		$V_{IN}=V_{NOM}+1.0V, I_{OUT}=10mA,$ $TEMP=-40$ to 85	-3		+3	%
V_{LNR}	Output Line Regulation	$V_{OUT}+0.5V < V_{IN} < 5.5V, I_{OUT}=10mA$		0.04	0.1	%/V
V_{LDR}	Output Load Regulation	$1mA < I_{OUT} < 600mA, V_{IN}=V_{NOM}+1.0V$		17	30	mV
V_{DROP}	Dropout Voltage (Applied for $V_{OUT} \geq 2.3V$)	$I_{OUT}=300mA$		180	240	mV
		$I_{OUT}=600mA$		360	450	
I_{OUTMAX}	Maximum Output Current		600			mA

Electrical Characteristics (continued)

$T_A=25^\circ\text{C}$, $V_{IN}=V_{OUT}+1\text{V}$, or $V_{IN}=2.5\text{V}$ for $V_{OUT}<1.5\text{V}$ unless otherwise specified

Symbol	Parameter	Conditions	EUP7907A			Unit
			Min.	Typ.	Max.	
Protection						
I_{LIMIT}	Current Limit		600	900		mA
T_{SD}	Thermal Shutdown Temperature	No Load, $V_{IN}=V_{EN}=5\text{V}$		170		
T_{SDHYS}	Thermal Shutdown Hysteresis	No Load, $V_{IN}=V_{EN}=5\text{V}$		30		

Note 1: Stresses listed as the above “Absolute Maximum Ratings” may cause permanent damage to the device. These are for stress ratings. Functional operation of the device at these or any other conditions beyond those indicated in the operational sections of the specifications is not implied. Exposure to absolute maximum rating conditions for extended periods may remain possibility to affect device reliability.

Note 2: Dropout is defined as $V_{IN}-V_{OUT}$ when V_{OUT} is 100mV below the value of V_{OUT} for $V_{IN}=V_{OUT}+0.5\text{V}$.

Note 3: Test time needed for V_{OUT} to reach 90% of final value

Typical Characteristics

Quiescent Current vs. Temperature

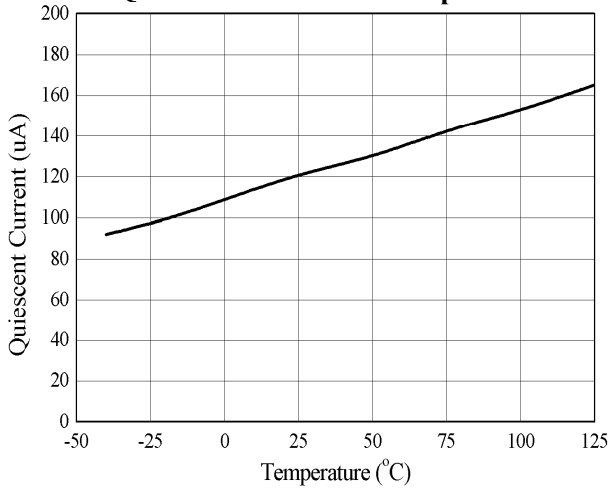

Shutdown Current vs. Temperature

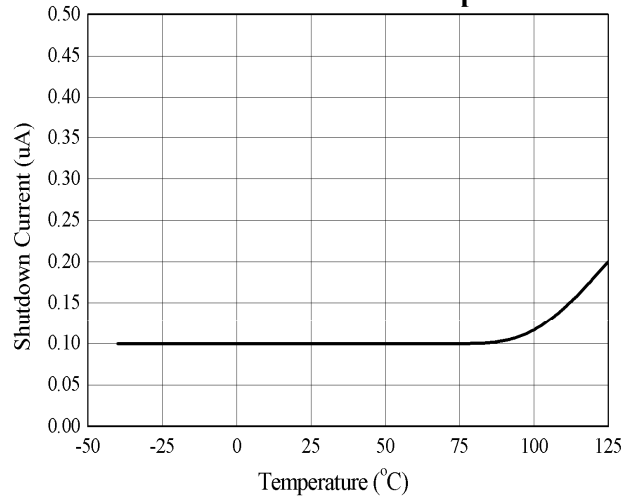

Output Voltage vs. Temperature

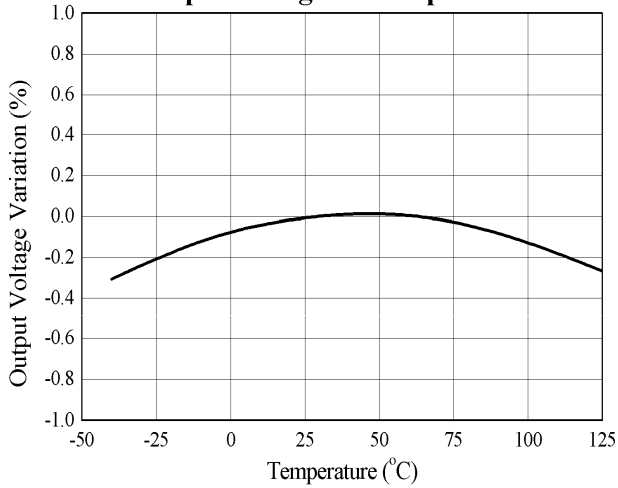

Enable/Disable Threshold vs. Temperature

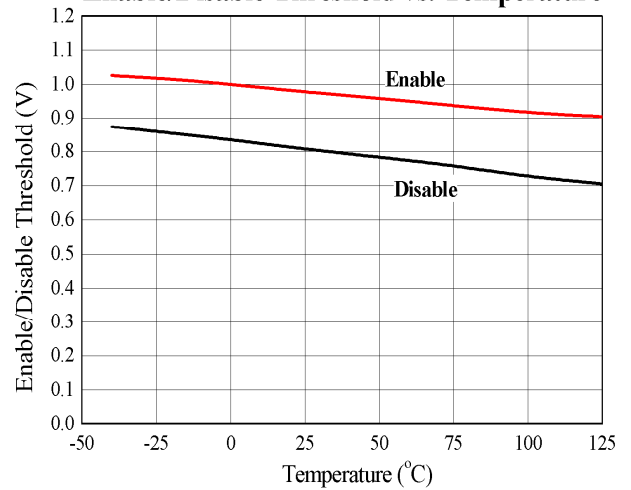

On Resistance vs. Temperature

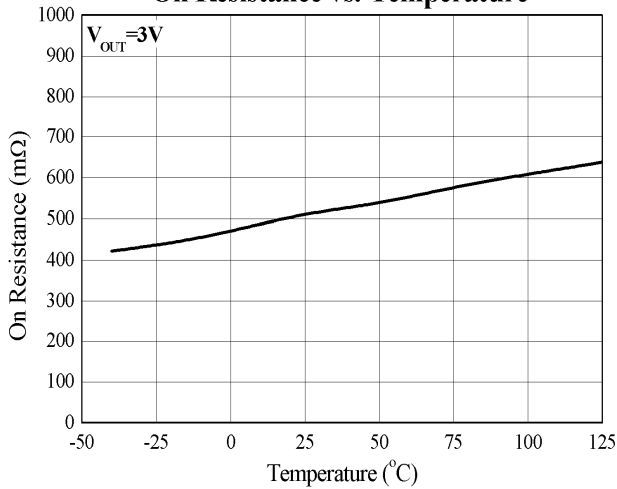

Pull Low Resistance vs. Input Voltage

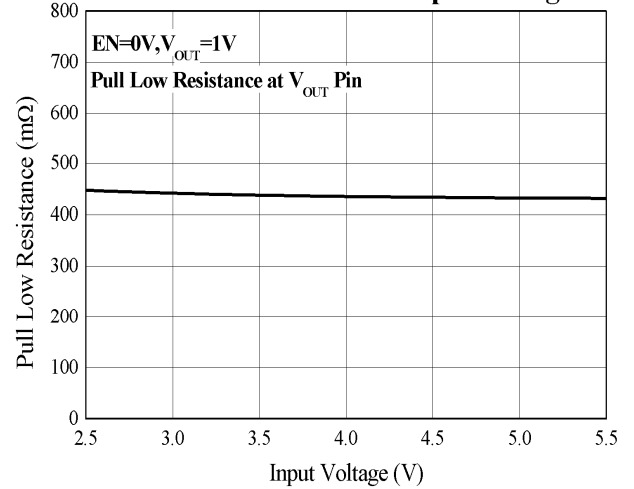

Typical Characteristics (continued)

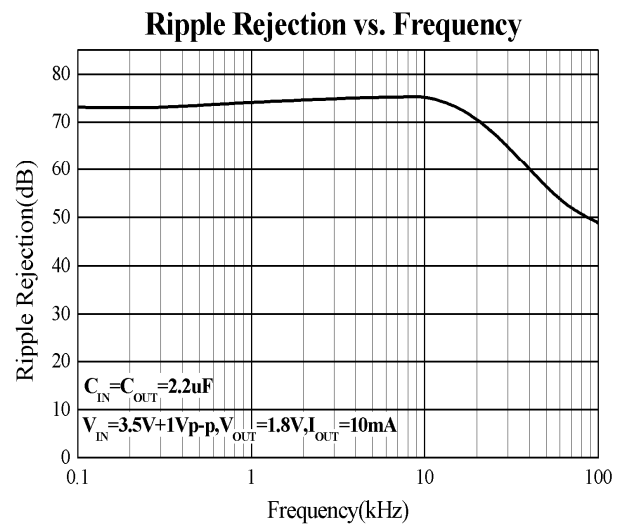
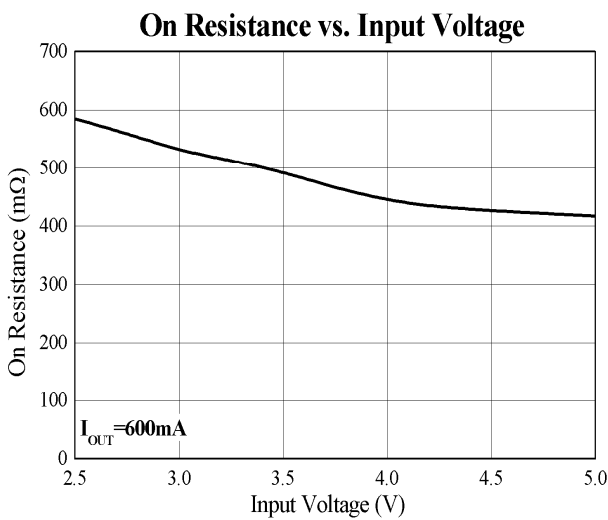
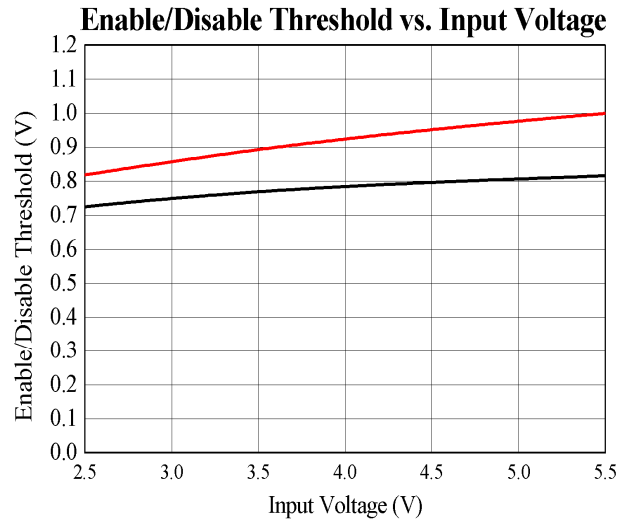
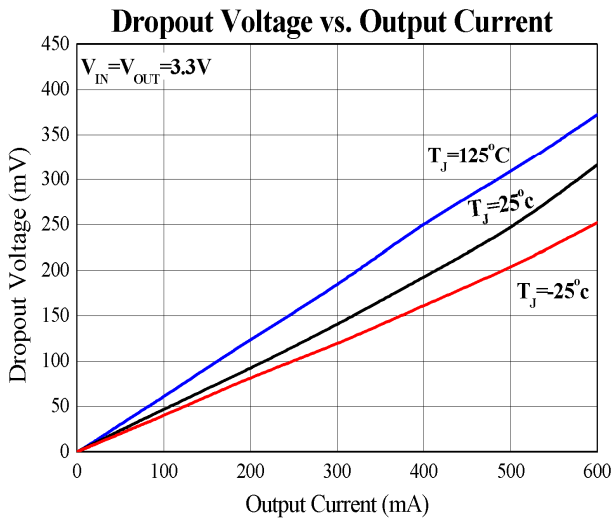
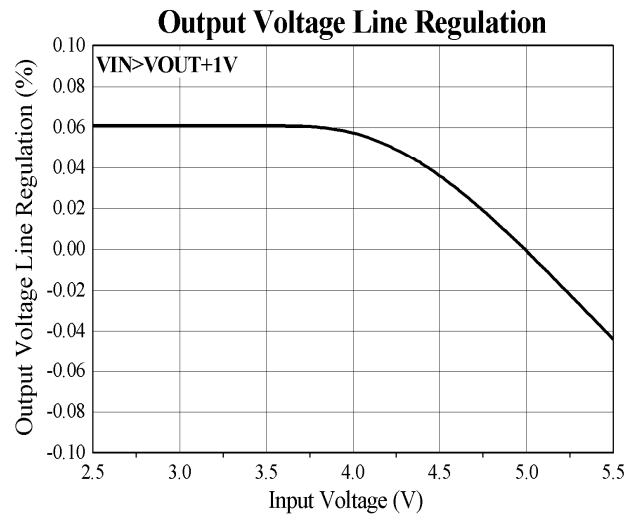
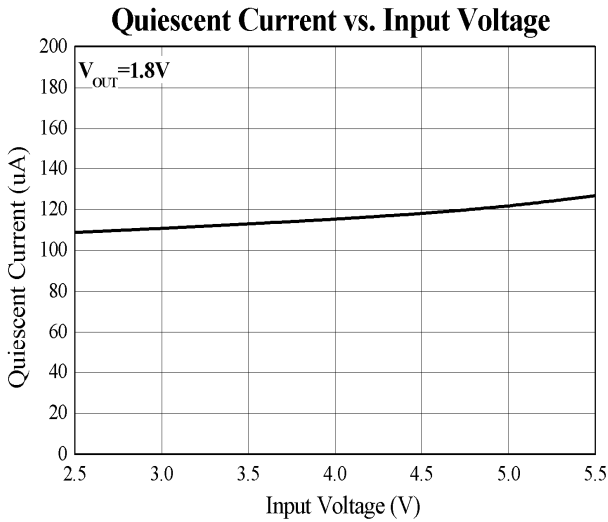

Typical Characteristics (continued)

Turn On Waveforms

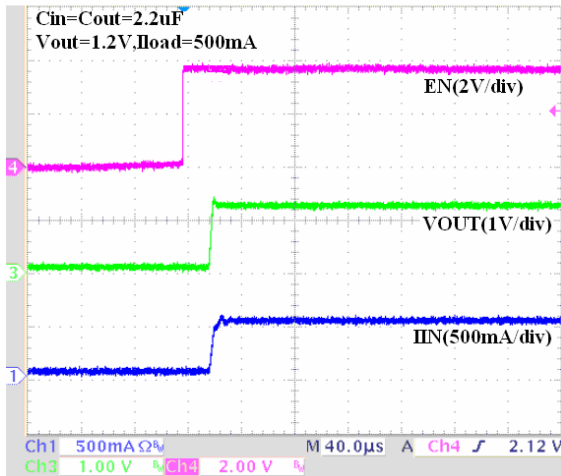

Turn Off Waveforms

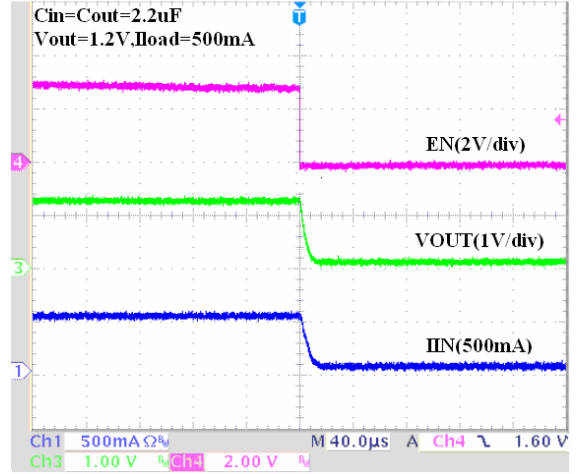

Power On Waveforms

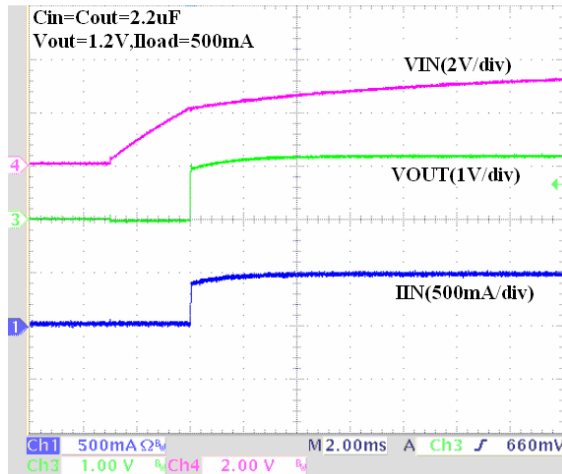

Power Off Waveforms

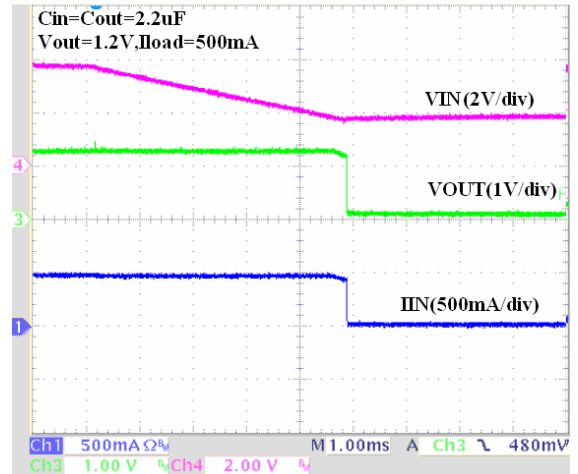

Load Transient Response

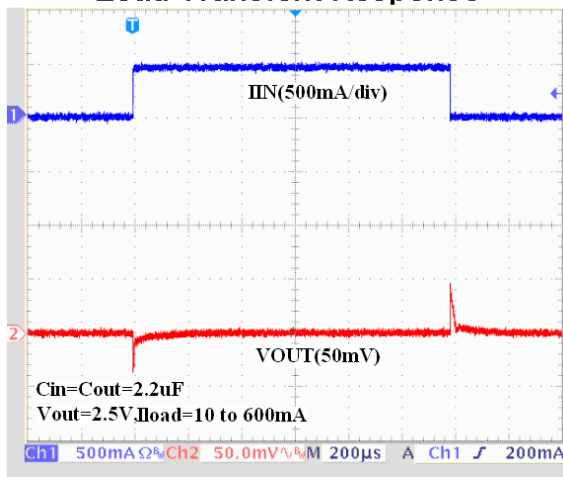

Line Transient Response

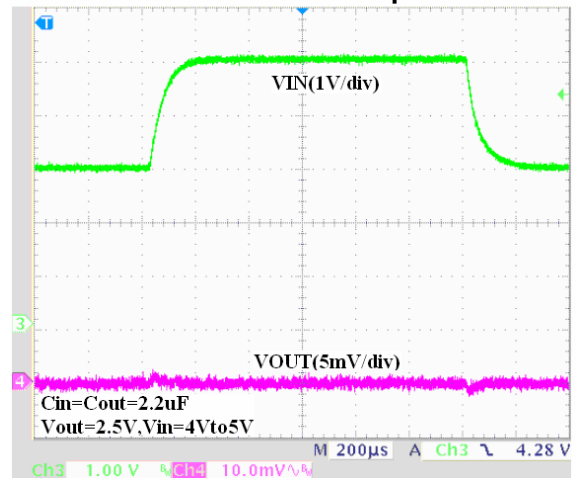

Function Description

The EUP7907A is a high output current, low dropout linear regulator with fast transient response and high PSRR. It offers high output accuracy, extremely low dropout voltage, low quiescent current and fast start-up time. It is designed to work with low-ESR ceramic capacitor, reducing the amount of the PCB area. Only a 2.2 μ F ceramic capacitor can make the device stable over the whole load range.

As shown in the function block diagram, the EUP7907A is composed of the bandgap reference voltage, the error amplifier, P-channel MOSFET pass transistor, internal resistor divider and some additional protection circuits. The reference voltage, connected to the cathode terminal of the error amplifier, compares with the feedback voltage to regulate the output voltage to make it constant over the whole load range. If the feedback voltage is lower than the reference voltage, the pass transistor gate is pulled low to increase its conductivity. This allows more current to flow to the output and increases the output voltage. If the feedback voltage is higher than the reference voltage, the pass transistor allows less current to flow to the output. The feedback point is the output of the internal or external resistor divider connected to the VOUT pin.

Supply Input Power on Reset

The input voltage supplies current to the output and the operation voltage of the internal circuit. The input voltage is monitored for power on reset (POR) to ensure the regulator is disabled when the input voltage is not high enough for normal operation. The POR threshold voltage is 2.1V at VIN rising typically.

Enable/Shutdown

The EUP7907A is disabled when the EN pin is connected to ground or the voltage less than 0.4V, reducing the quiescent current to less than 1 μ A. In the shutdown mode the error amplifier, the reference voltage, the driver and the pass transistor are all disabled. Make this pin higher than 1.5V to enable the device. If this pin of EUP7907A is floating, the regulator on/off is unstable. To assure proper operation the EN should be pulled higher than the level listed in the Electrical Characteristics section.

Soft Stop

When the regulator is disabled, an internal 400 Ω resistor is connected between V_{OUT} and GND. This is intended to discharge C_{OUT}. The internal resistor is not used when the device turns on.

Current Limit

The EUP7907A includes a current limit circuit to monitor the gate voltage of the pass transistor to limit the output current. When the output current is higher than the over-current limit, the circuit will clamp the gate voltage of the pass transistor to keep the current flowing to the output. The typical value is 0.9A.

Thermal Shutdown

The EUP7907A monitor its temperature automatically. When the operation junction temperature exceeds 170 °C, the OTP circuit starts the thermal shutdown function to turn the pass transistor off until it cooled down by 30 °C then the pass transistor turned on again. For continue operation, do not exceed absolute maximum operation junction temperature. The circuit is a non-latched protection.

Application Information

External Capacitor

Like other low-dropout regulator, the EUP7907A requires external capacitors for stability. It is specifically designed for low-ESR capacitors requiring minimum PCB area and smallest components.

Input Capacitor

A 2.2uF capacitor is required between the VIN pin and the GND pin. Place it as close as possible to the device. There are no requirements for the ESR on the input capacitor, but the tolerance and temperature coefficient must be considered when selecting the capacitor to ensure the capacitance will be 2.2uF over the whole operating temperature range.

Output Capacitor

The EUP7907A is designed specifically to work with very small ceramic output capacitors. A 2.2uF to 10uF with 5mΩ to 500mΩ ESR range is suitable in the EUP7907A application circuit. The ESR of a typical 2.2uF ceramic capacitor is about 20mΩ, which easily meets the ESR requirement for stability.

Capacitor Characteristics

More consideration should be taken when selecting the capacitor because its capacitance can vary with temperature. The capacitor type X7R or X5R, which operates over a temperature range of -40 to +85, will only vary within ±15%. Some large value ceramic capacitors are manufactured with Z5U or T5V temperature characteristics. Their capacitance can drop by more than 50% as the temperature goes from 25 to 85. Therefore the capacitor type X7R or X5R is recommended in applications where the ambient temperature will change significantly above or below 25.

No Load Stability

The EUP7907A will remain stable and in regulation with no external load. This is special important in CMOS RAM keep-alive applications.

Thermal Considerations

Thermal protection limits power dissipation in EUP7907A. When the operation junction temperature exceeds 170°C, the OTP circuit starts the thermal shutdown function and turns the pass element off. The pass element turns on again after the junction temperature cools by 30°C.

For continuous operation, do not exceed absolute maximum operation junction temperature 125°C. The power dissipation definition in device is:

$$P_D = (V_{IN} - V_{OUT}) \times I_{OUT} + V_{IN} \times I_Q \quad (EQ.3)$$

The maximum power dissipation depends on the thermal resistance of IC package, PCB layout, the rate of surroundings airflow and temperature difference between junction to ambient. The maximum power dissipation can be calculated by following formula :

$$P_{D(MAX)} = (T_{J(MAX)} - T_A) / \theta_{JA} \quad (EQ.4)$$

Where $T_{J(MAX)}$ is the maximum operation junction temperature 125°C, T_A is the ambient temperature and the θ_{JA} is the junction to ambient thermal resistance.

For recommended operating conditions specification of EUP7907A, where $T_{J(MAX)}$ is the maximum junction temperature of the die (125°C) and T_A is the operated ambient temperature. The junction to ambient thermal resistance θ_{JA} is layout dependent. For SOT-23-5 package, the thermal resistance θ_{JA} is 220°C/W on the standard thermal test board. For TDFN-6 package, the thermal resistance θ_{JA} is 90°C/W on the standard thermal test board. The maximum power dissipation at $T_A = 25^\circ\text{C}$ can be calculated by following formula :

$$P_{D(MAX)} = (125^\circ\text{C} - 25^\circ\text{C}) / 220 = 0.455\text{W} \quad (EQ.5)$$

for SOT23-5 package

$$P_{D(MAX)} = (125^\circ\text{C} - 25^\circ\text{C}) / 90 = 1.111\text{W} \quad (EQ.6)$$

for TDFN-6 package

The maximum power dissipation depends on operating ambient temperature for fixed $T_{J(MAX)}$ and thermal resistance θ_{JA} . For EUP7907A packages, the Figure 3 of derating curves allows the designer to see the effect of rising ambient temperature on the maximum power allowed.

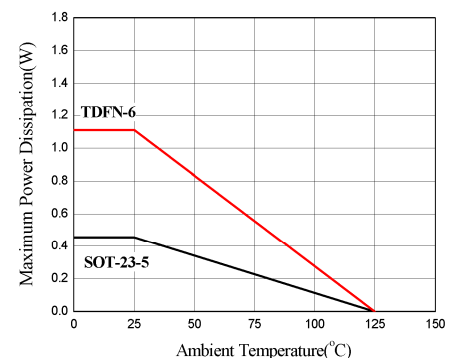
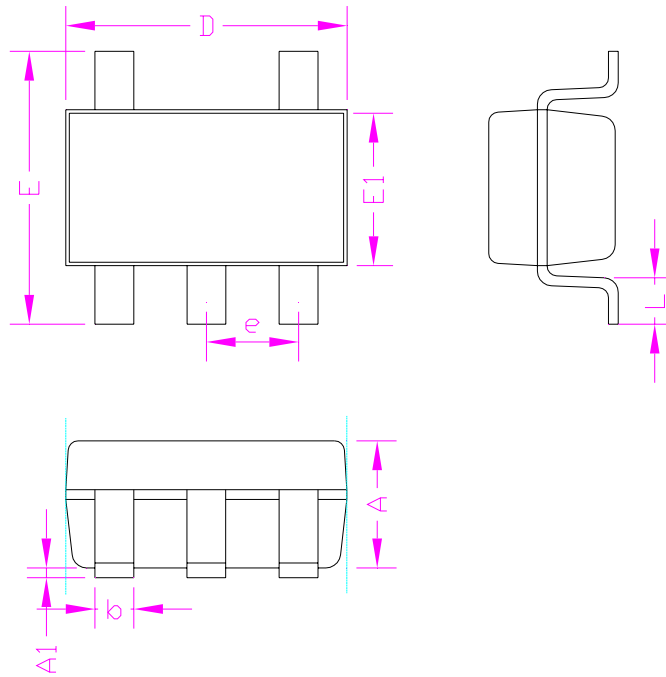

Figure 5. Power Dissipation for EUP7907A Packages

The EUP7907A is available in two standard packages: TDFN-6 and SOT23-5 packages.

Packaging Information

SOT23-5



SYMBOLS	MILLIMETERS		INCHES	
	MIN.	MAX.	MIN.	MAX.
A	-	1.30	-	0.052
A1	0.00	0.15	0.000	0.006
D	2.90		0.114	
E1	1.60		0.063	
E	2.60	3.00	0.102	0.118
L	0.30	0.60	0.012	0.024
b	0.30	0.50	0.012	0.020
e	0.95		0.037	

TDFN-6

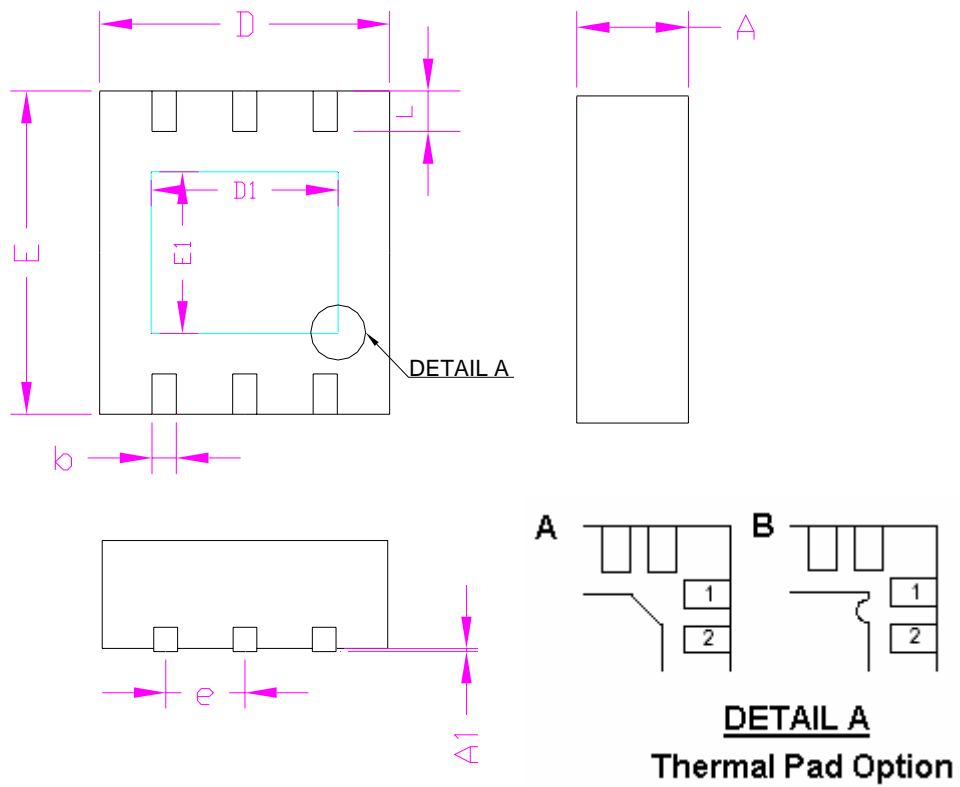

SYMBOLS	MILLIMETERS		INCHES	
	MIN.	MAX.	MIN.	MAX.
A	0.70	0.80	0.028	0.031
A1	0.00	0.05	0.000	0.002
b	0.20	0.40	0.008	0.016
D	1.90	2.10	0.075	0.083
D1	1.40		0.055	
E	1.90	2.10	0.075	0.083
E1	0.80		0.031	
e	0.65		0.026	
L	0.25	0.45	0.010	0.018