

## 3-Terminal 1 Amp Adjustable Voltage Regulator

### Features

- Typical 1% Output Voltage Tolerance
- Typical 0.01%/V Line Regulation
- Typical 0.2% Load Regulation
- Very Low Dropout Voltage: 1.2V at 1A Output Current
- Trimmed Current Limit
- On-chip Thermal Protection
- Operation Junction Temperature: 0 to 125°C
- Available in RoHS Compliant, Lead Free Packaging

### TO-220 Package

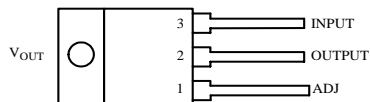

### Applications

- PC Motherboard
- LCD Monitor
- Graphics Card
- DVD Player
- Network Interface Card/Switch
- Telecom Equipment
- Printer and other Peripheral Equipment

### General Description

The SP317 is an adjustable three-terminal positive voltage regulator with a very low dropout of 1.2V at 1A output current. Using 2 external resistors, the SP317 can provide an adjustable output voltage down to 1.25V.

The SP317 includes a circuit of trimmed bandgap reference to assure output voltage accuracy to be within 1%. It also provides current limiting and thermal shutdown. The current limit is trimmed to ensure specified output current and controlled short-circuit current. The On-chip thermal limiting provides protection against any combination of overload and ambient temperature that would create excessive junction temperature.

The SP317 is available in the standard SOT-223, TO-220, TO-252 and TO-263 power packages.

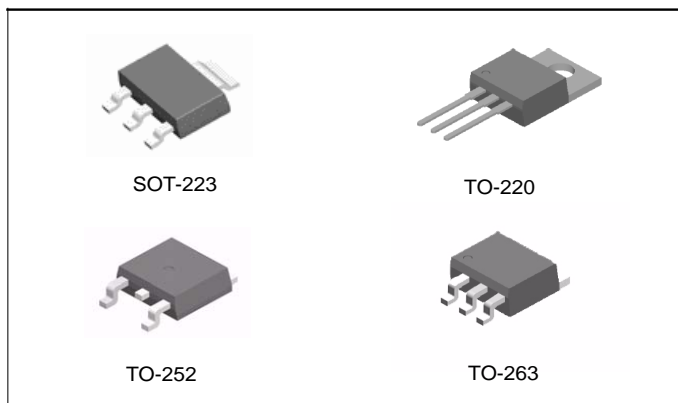

Figure 1. Package Types of SP317

## Pin Configuration

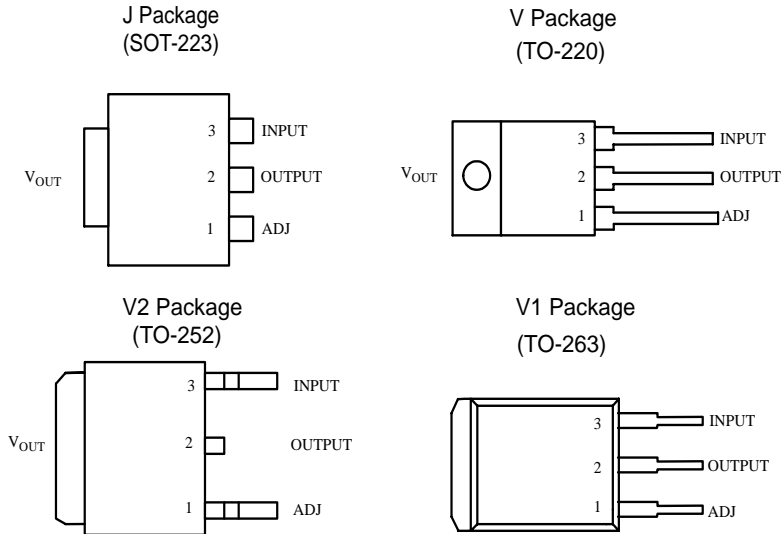

Figure 2. Pin Configuration of SP317 (Top View)

## Functional Block Diagram

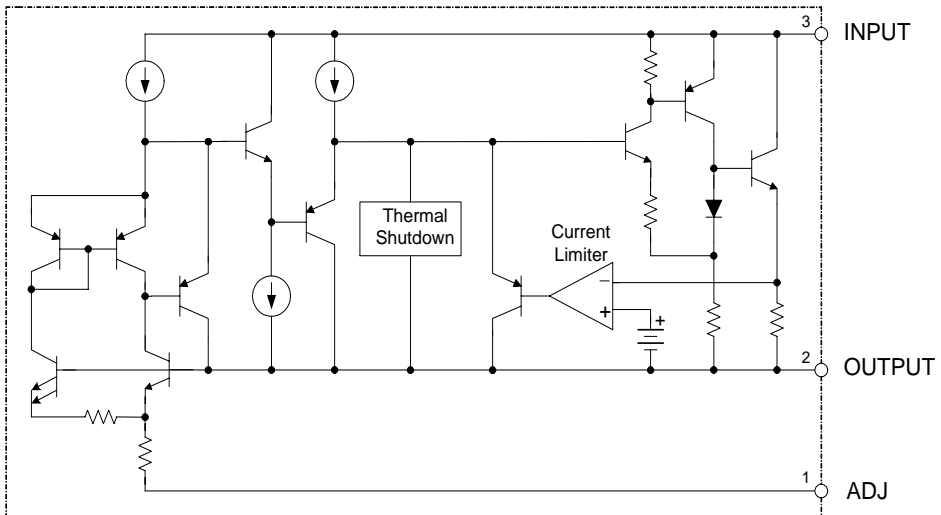

Figure 3. Functional Block Diagram of SP317

## Absolute Maximum Ratings (Note 1)

Parameter	Symbol	Min	Max	Unit
Input Voltage	$V_{IN}$		20	V
Maximum Junction Temperature	$T_J$		150	°C
Storage Temperature	$T_S$	-65	150	°C
Lead Temperature (Soldering, 10sec)	$T_{LEAD}$		300	°C
ESD (Human Body Model)	ESD		4000	V

Note1: Stresses greater than those listed under "Absolute Maximum Ratings" may cause permanent damage to the device. These are stress ratings only, and functional operation of the device at these or any other conditions beyond those indicated under "Recommended Operating Conditions" is not implied. Exposure to "Absolute Maximum Ratings" for extended periods may affect device reliability.

## Recommended Operating Conditions

Parameter	Symbol	Min	Max	Unit
Input Voltage	$V_{IN}$	$V_{OUT}+2$	15	V
Operating Junction Temperature Range	$T_J$	0	125	°C

## Electrical Characteristics

(Typicals and limits apply for  $T_J = 25^\circ\text{C}$ ,  $P \leq$  Maximum Power Dissipation unless otherwise specified.)(Note 2)

Parameter	Symbol	Conditions	Min	Typ	Max	Unit
Reference Voltage	$V_{REF}$	$10\text{mA} \leq I_{OUT} \leq 1\text{A}$ , $3\text{V} \leq (V_{IN} - V_{OUT}) \leq 10\text{V}$	1.20	1.25	1.30	V
Line Regulation	$S_V$	$I_{OUT} \leq 20\text{mA}$ , $3\text{V} \leq V_{IN} - V_{OUT} \leq 10\text{V}$		0.01	0.04	%/V
Load Regulation	$S_I$	$V_{IN} - V_{OUT} = 2\text{V}$ , $10\text{mA} \leq I_{OUT} \leq 1\text{A}$		0.2	0.4	%
Thermal Regulation		20ms Pulse		0.04	0.07	%/W
Dropout Voltage	$\Delta V$	$I_{OUT} = 1\text{A}$		1.2	1.3	V
Current Limit	$I_{LIMIT}$	$(V_{IN} - V_{OUT}) = 2\text{V}$	1.2	1.5	1.8	A
Adjust Pin Current				50	100	$\mu\text{A}$
Adjust Pin Current Change		$1.4\text{V} \leq (V_{IN} - V_{OUT}) \leq 10\text{V}$ , $10\text{mA} \leq I_{OUT} \leq 1\text{A}$		0.2	5	$\mu\text{A}$
Minimum Load Current		$3\text{V} \leq (V_{IN} - V_{OUT}) \leq 15\text{V}$		3.5	10	mA
Ripple Rejection		$f = 120\text{Hz}$ , $C_{OUT} = 1\mu\text{F}$ Tantalum, $(V_{IN} - V_{OUT}) = 3\text{V}$ , $I_{OUT} = 1\text{A}$	60	75		dB
Temperature Stability				1		%
Long -Term Stability		$T_A = 125^\circ\text{C}$ , 1000hrs		0.3		%
RMS Output Noise (% of $V_{OUT}$ )		$T_A = 25^\circ\text{C}$ , $10\text{Hz} \leq f \leq 10\text{kHz}$		0.003		%
Thermal Resistance, Junction to Case		SOT-223 TO-252 TO-220 TO-263		15 10 4.5 4		$^\circ\text{C}/\text{W}$
Thermal Shutdown		Junction Temperature		150		$^\circ\text{C}$
Thermal Shutdown Hysteresis				25		$^\circ\text{C}$

Note 2: Maximum Power Dissipation is Package Type and Case Temperature dependent. Please see Figure 12.

## Typical Performance Characteristics

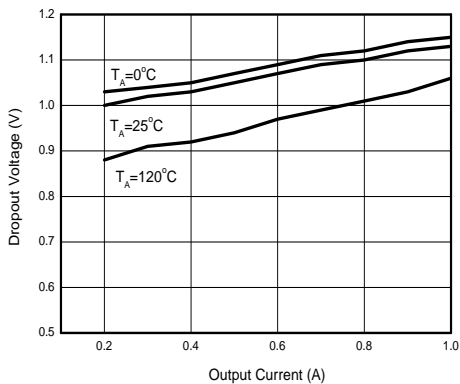

Figure 5. Dropout Voltage vs. Output Current

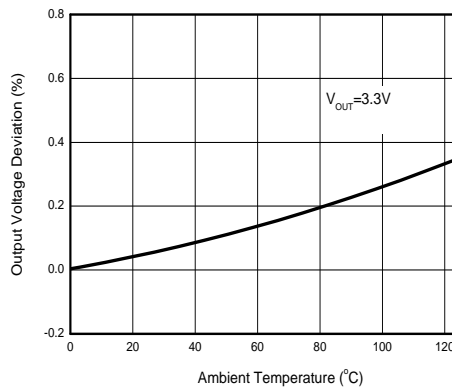

Figure 6. Load Regulation vs. Temperature

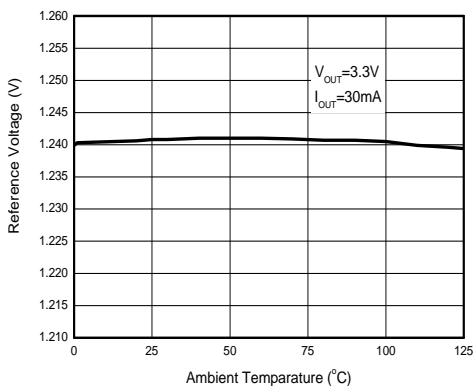

Figure 7. Reference Voltage vs. Temperature

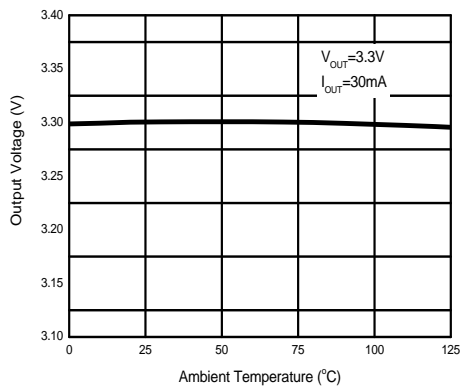

Figure 8. Output Voltage vs. Temperature

## Typical Performance Characteristics (Continued)

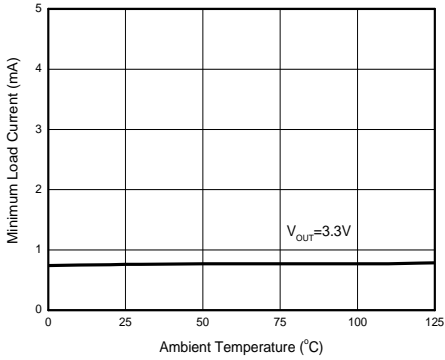

Figure 9. Minimum Load Current vs. Temperature

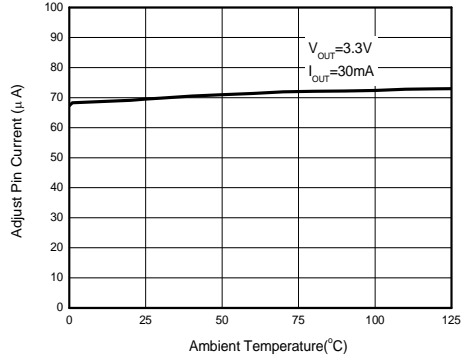

Figure 10. Adjust Pin Current vs. Temperature

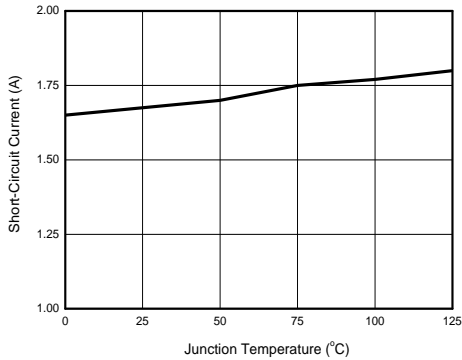

Figure 11. Short-Circuit Current vs. Temperature

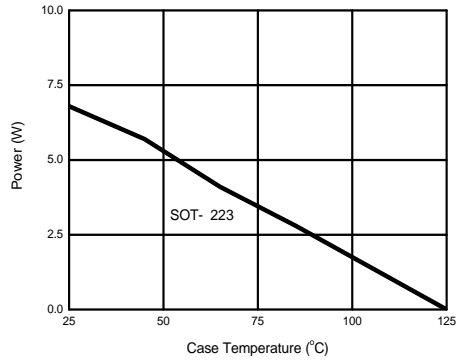

Figure 12. Maximum Power Dissipation

## Typical Performance Characteristics (Continued)

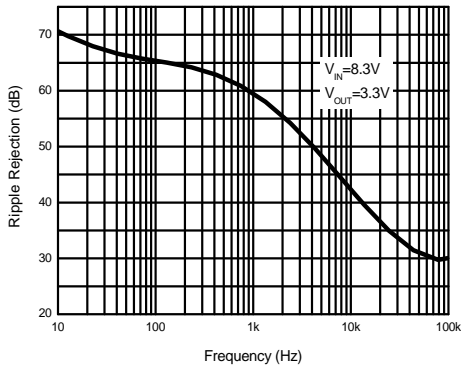

Figure 13. Ripple Rejection vs. Frequency

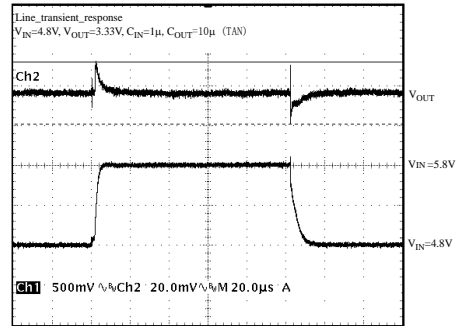

Figure 14. Line Transient Response

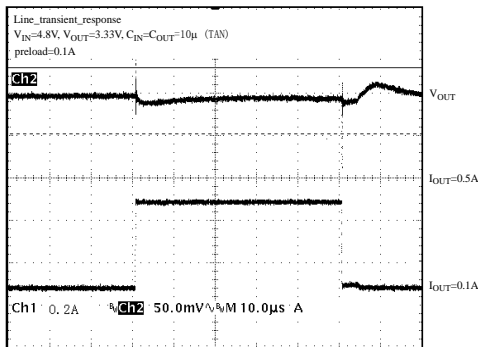

Figure 15. Load Transient Response

## Typical Application

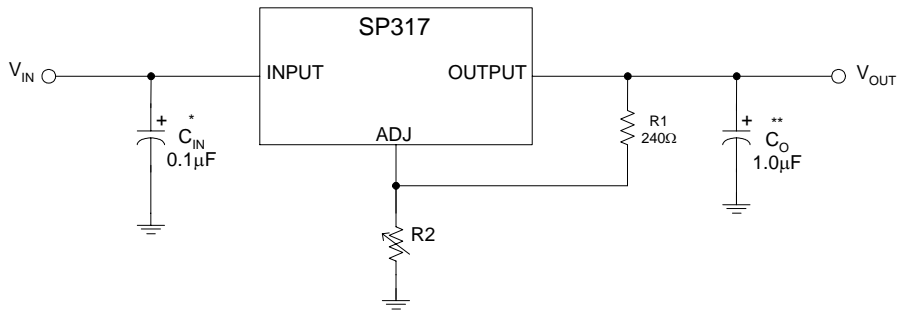

Figure 4. Typical Application of SP317

\* =  $C_{IN}$  is required if the regulator is located near power supply filter.

\*\*=  $C_O$  is needed for stability and it improves transient response.

$$V_{OUT} = V_{REF} \times (1 + R2/R1) + I_{ADJ} \times R2$$

Since  $I_{ADJ}$  is controlled to less than 100 $\mu$ A, the error associated with this term is negligible in most applications.



Mechanical Dimensions

SOT-223

Unit: mm(inch)

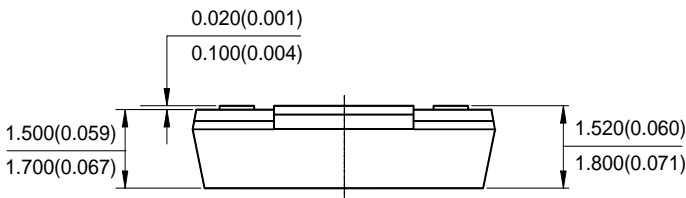
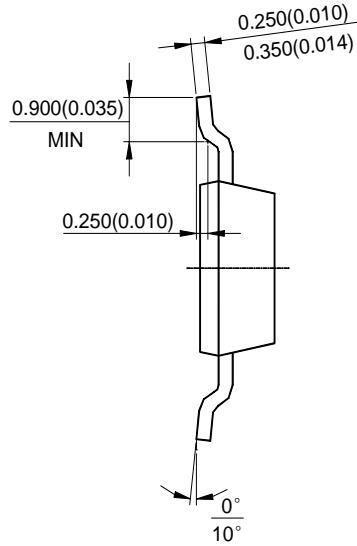
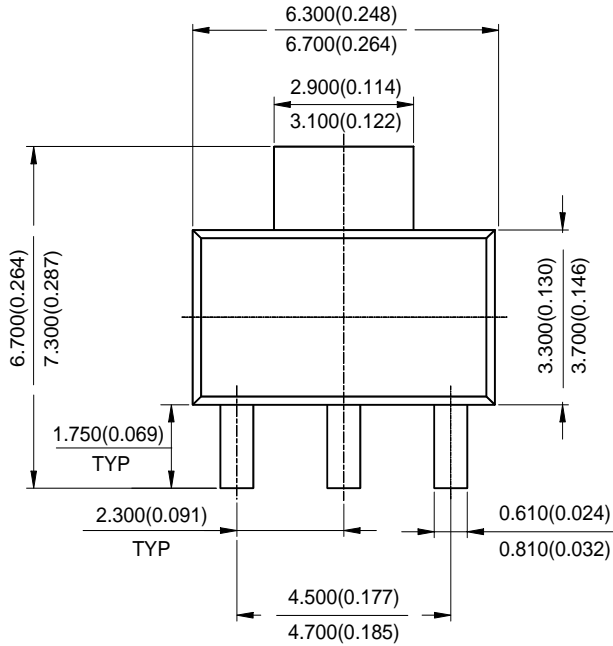



Mechanical Dimensions (Continued)

TO-252

Unit: mm(inch)

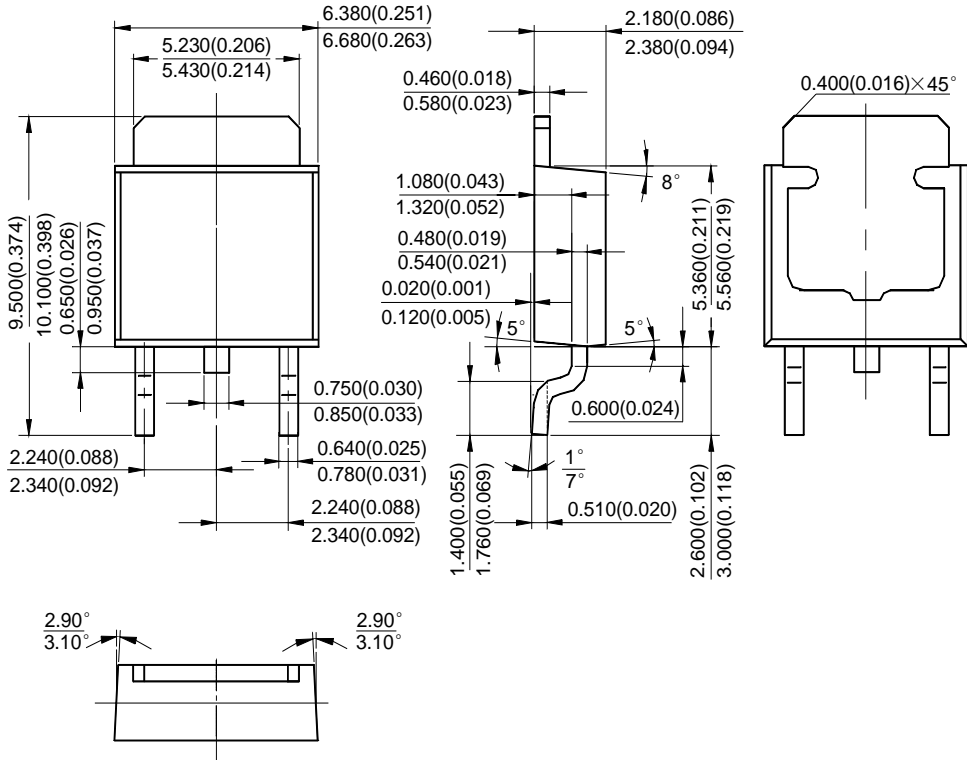



SP317

Part Name \_\_\_\_\_ /TR: Tape and Reel  
 \_\_\_\_\_ Blank: Tube

Package \_\_\_\_\_ -L: Lead Free and  
 \_\_\_\_\_ RoHS Compliant

J: SOT-223  
 V: TO-220  
 V2: TO-252  
 V1: TO-263

Part Number	Temperature Range	Voltage Tolerance	Output Voltage	Package	Pin Count	Packing Type
SP317J-L/TR	0°C to +125°C	1.0%	Adj	SOT-223	3	2,500/TR
SP317V-L	0°C to +125°C	1.0%	Adj	TO-220	3	50/TUBE
SP317V2-L/TR	0°C to +125°C	1.0%	Adj	TO-252	3	2,500/TR
SP317V1-L/TR	0°C to +125°C	1.0%	Adj	TO-263	3	800/TR



Sipex Corporation

**Headquarters and Sales Office**  
 233 South Hillview Drive  
 Milpitas, CA 95035  
 TEL: (408) 934-7500  
 FAX: (408) 935-7600

Sipex Corporation reserves the right to make changes to any products described herein. Sipex does not assume any liability arising out of the application or use of any product or circuit described herein; neither does it convey any license in its patents right nor the rights of others.

[www.BDTC.com/Exar/](http://www.BDTC.com/Exar/)