



# 600mA 1.5MHz Synchronous Step Down Converter

## GENERAL DESCRIPTION

The SP6669 is a synchronous current mode PWM step down (buck) converter capable of delivering up to 600mA of current. It features a pulse skip mode (PSM) for light load efficiency and a LDO mode for 100% duty cycle.

With a 2.5V to 5.5V input voltage range and a 1.5MHz switching frequency, the SP6669 allows the use of small surface mount inductors and capacitors ideal for battery powered portable applications. The internal synchronous switch increases efficiency and eliminates the need for an external Schottky diode. Low output voltages are easily supported with the 0.6V feedback reference voltage. The SP6669 is available in an adjustable output voltage version, using an external resistor divider circuit, as well as fixed output voltage versions of 1.2V, 1.5V and 1.8V.

Built-in over temperature and output over voltage lock-out protections insure safe operations under abnormal operating conditions.

The SP6669 is offered in a RoHS compliant, "green"/halogen free 5-pin SOT23 package.

## APPLICATIONS

- Portable Equipments
- Battery Operated Equipments
- Audio-Video Equipments
- Networking & Telecom Equipments

## FEATURES

- **Guaranteed 600mA Output Current**
  - Input Voltage: 2.5V to 5.5V
- **1.5MHz PWM Current Mode Control**
  - 100% Duty Cycle LDO Mode Operations
  - Achieves 95% Efficiency
- **Fixed/Adjustable Output Voltage Range**
  - As Low as 0.6V with  $\pm 3\%$  Accuracy
  - 1.2V, 1.5V, 1.8V Fixed Voltage Options
- **Excellent Line/Load Transient Response**
- **200 $\mu$ A Quiescent Current**
- **Over Temperature Protection**
- **RoHS Compliant "Green"/Halogen Free 5-Pin SOT23 Package**

## TYPICAL APPLICATION DIAGRAM

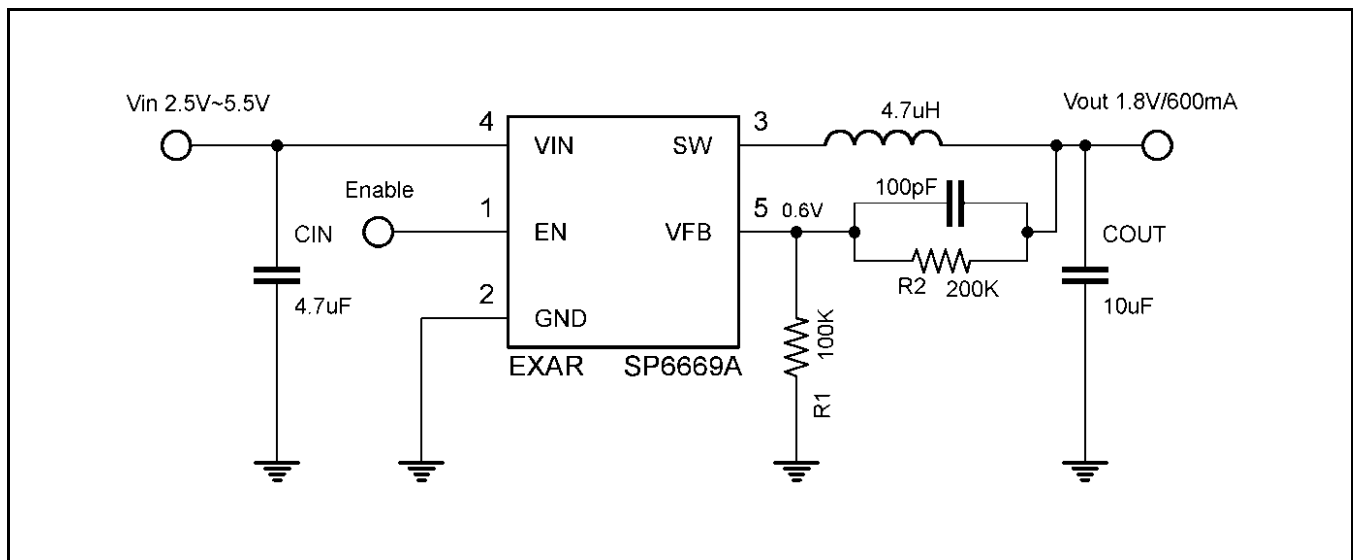

Fig. 1: SP6669 Application Diagram (Adj. version shown)

## 600mA 1.5MHz Synchronous Step Down Converter

### ABSOLUTE MAXIMUM RATINGS

These are stress ratings only and functional operation of the device at these ratings or any other above those indicated in the operation sections of the specifications below is not implied. Exposure to absolute maximum rating conditions for extended periods of time may affect reliability.

Input Voltage $V_{IN}$ .....	-0.3V to 6.0V
Enable $V_{FB}$ Voltage .....	-0.3V to $V_{IN}$
SW Voltage.....	-0.3V to ( $V_{IN}+0.3V$ )
PMOS Switch Source Current (DC).....	800mA
NMOS Switch Sink Current .....	800mA
Peak Switch Sink/Source Current .....	1.3A
Operating Junction Temperature <sup>1</sup> .....	125°C
Storage Temperature .....	-65°C to 150°C
Lead Temperature (Soldering, 10 sec).....	260°C
ESD Rating (HBM - Human Body Model) .....	2kV
ESD Rating (MM - Machine Model) .....	200V

### OPERATING RATINGS

Input Voltage Range $V_{IN}$ .....	2.7V to 5.5V
Operating Temperature Range .....	-40°C to 85°C
Thermal Resistance $\theta_{JA}$ .....	250°C/W
Thermal Resistance $\theta_{JC}$ .....	90°C/W

Note 1:  $T_j$  is a function of the ambient temperature  $T_A$  and power dissipation  $P_D$  ( $T_j = T_A + P_D \times 250^\circ\text{C/W}$ ).

### ELECTRICAL SPECIFICATIONS

Specifications with standard type are for an Operating Junction Temperature of  $T_j = 25^\circ\text{C}$  only; limits applying over the full Operating Junction Temperature range are denoted by a “•”. Minimum and Maximum limits are guaranteed through test, design, or statistical correlation. Typical values represent the most likely parametric norm at  $T_A = 25^\circ\text{C}$ , and are provided for reference purposes only. Unless otherwise indicated,  $V_{IN} = 3.6V$ .

Parameter	Min.	Typ.	Max.	Units	Conditions
Feedback Current $I_{VFB}$			$\pm 30$	nA	
Regulated Feedback Voltage $V_{FB}$	0.588	0.600	0.612	V	$T_A = 25^\circ\text{C}$
Reference Voltage Line Regulation $\Delta V_{FB}$			0.4	%/V	• $V_{IN} = 2.5V$ to 5.5V
Output Voltage Accuracy $\Delta V_{OUT}\%$	-3		+3	%	•
Output Over-Voltage Lockout $\Delta V_{OVL}$	20	50	80	mV	$\Delta V_{OVL} = V_{OVL} - V_{FB}$ (Adj.)
	2.5	7.8	13	%	$\Delta V_{OVL} = V_{OVL} - V_{OUT}$ (Fixed)
Output Voltage Line Regulation $\Delta V_{OUT}$			0.4	%/V	• $V_{IN} = 2.5V$ to 5.5V
Peak Inductor Current $I_{PK}$		1.0		A	$V_{IN} = 3V$ , $V_{FB} = 0.5V$ or $V_{OUT} = 90\%$ , Duty cycle < 35%
Output Voltage Load Regulation $V_{LOADREG}$		0.5		%	
Quiescent Current <sup>2</sup> $I_Q$		200	340	$\mu\text{A}$	$V_{FB} = 0.5V$ or $V_{OUT} = 90\%$
Shutdown Current $I_{SHUTDOWN}$		0.1	1	$\mu\text{A}$	$V_{EN} = 0V$ , $V_{IN} = 4.2V$
Oscillator Frequency $f_{OSC}$	1.2	1.5	1.8	MHZ	• $V_{FB} = 0.6V$ or $V_{OUT} = 100\%$
		290		Hz	• $V_{FB} = 0V$ or $V_{OUT} = 0V$
RDS(ON) of PMOS $R_{PFET}$		0.45	0.55	$\Omega$	$I_{SW} = 100mA$
RDS(ON) of NMOS $R_{NFET}$		0.40	0.50	$\Omega$	$I_{SW} = 100mA$
SW Leakage $I_{LSW}$			$\pm 1$	$\mu\text{A}$	$V_{EN} = 0V$ , $V_{SW} = 0V$ or 5V, $V_{IN} = 5V$
Enable Threshold $V_{EN}$			1.2	V	•
Shutdown Threshold $V_{EN}$	0.4			V	•
EN Leakage Current $I_{EN}$			$\pm 1$	$\mu\text{A}$	•

Note 1: The Switch Current Limit is related to the Duty Cycle. Please refer to figure 15 for details.

Note 2: Dynamic quiescent current is higher due to the gate charge being delivered at the switching frequency.

**BLOCK DIAGRAM**

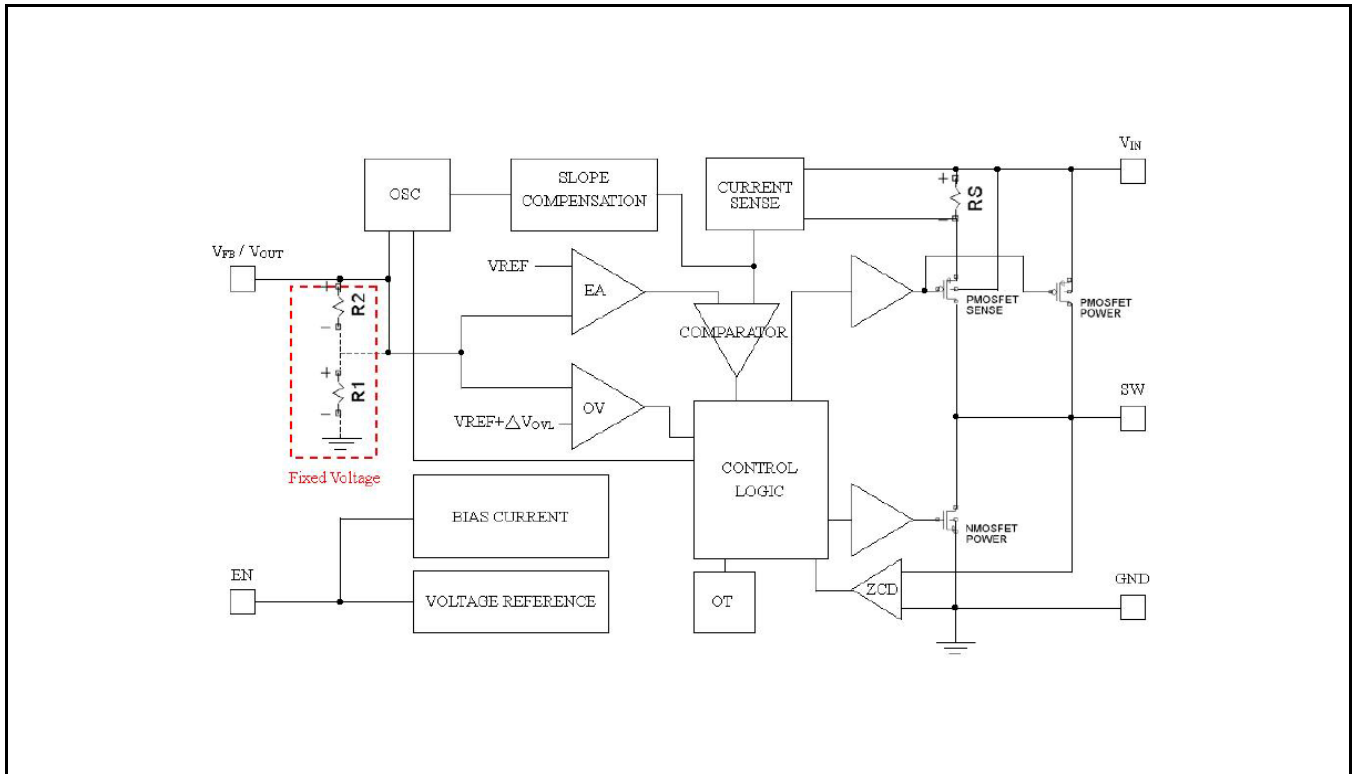

Fig. 2: SP6669 Block Diagram

**PIN ASSIGNMENT**

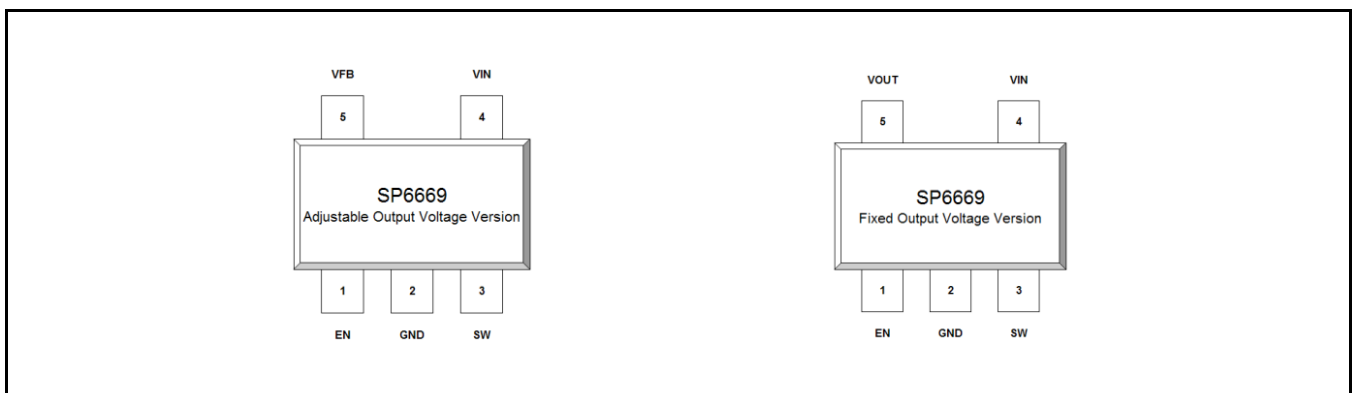

Fig. 3: SP6669 Pin Assignment

**600mA 1.5MHz Synchronous Step Down Converter**

**PIN DESCRIPTION**

Name	Pin Number	Description
EN	1	Enable Pin. Do not leave the pin floating. $V_{EN} < 0.4V$ : Shutdown mode $V_{EN} > 1.2V$ : Device enabled
GND	2	Ground Signal
SW	3	Switching Node
VIN	4	Power Supply Pin. Must be decoupled to ground with a 4.7 $\mu$ F or greater ceramic capacitor.
VFB	5	Adjustable Version Feedback Input Pin. Connect VFB to the center point of the resistor divider.
VOUT		Fixed Output Voltage Version, Output Voltage Pin. An internal resistive divider divides the output voltage down for comparison to the internal reference voltage.

**ORDERING INFORMATION**

Part Number	Temperature Range	Marking	Package	Packing Quantity	Note 1	Note 2
SP6669AEK-L/TRR3	-40°C ≤ T <sub>A</sub> ≤ +85°C	QBWW	SOT23-5	3K/Tape & Reel	Halogen Free	Adjustable output voltage
SP6669BEK-L/TRR3	-40°C ≤ T <sub>A</sub> ≤ +85°C	RBWW	SOT23-5	3K/Tape & Reel	Halogen Free	1.2V fixed output voltage
SP6669CEK-L/TRR3	-40°C ≤ T <sub>A</sub> ≤ +85°C	SBWW	SOT23-5	3K/Tape & Reel	Halogen Free	1.5V fixed output voltage
SP6669DEK-L/TRR3	-40°C ≤ T <sub>A</sub> ≤ +85°C	TBWW	SOT23-5	3K/Tape & Reel	Halogen Free	1.8V fixed output voltage
SP6669EB	SP6669 Evaluation Board					

“YY” = Year – “WW” = Work Week – “X” = Lot Number; when applicable.

Note that the SP6669 series is packaged in Tape and Reel with a reverse part orientation as per the following diagram

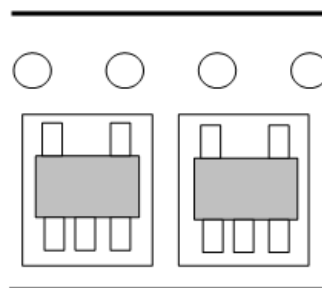

## 600mA 1.5MHz Synchronous Step Down Converter

### TYPICAL PERFORMANCE CHARACTERISTICS

All data taken at  $V_{IN} = 2.7V$  to  $5.5V$ ,  $T_J = T_A = 25^\circ C$ , unless otherwise specified - Schematic and BOM from Application Information section of this datasheet.

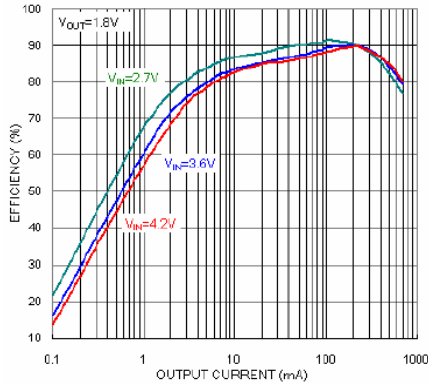

Fig. 4: Efficiency vs Output Current (mA)

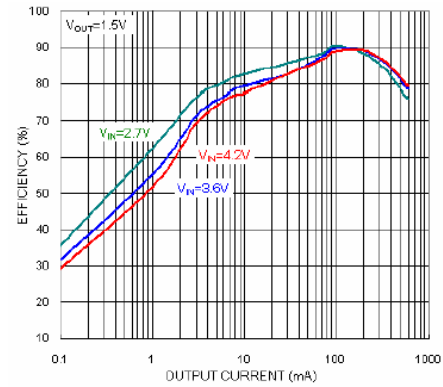

Fig. 5: Efficiency vs Output Current (mA)

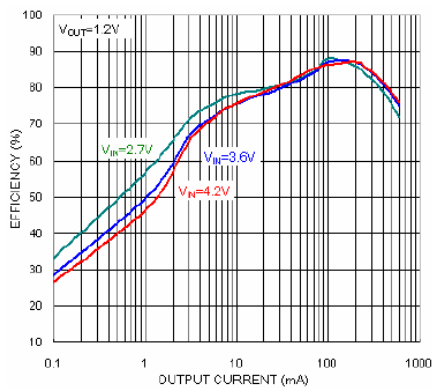

Fig. 6: Efficiency vs Output Current (mA)

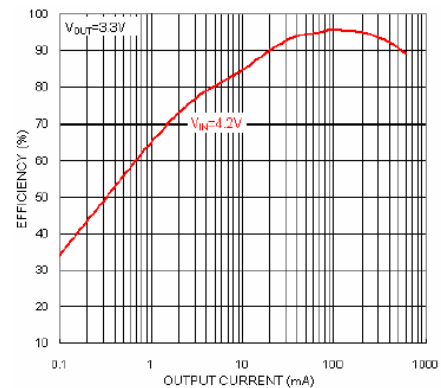

Fig. 7: Efficiency vs Output Current (mA)

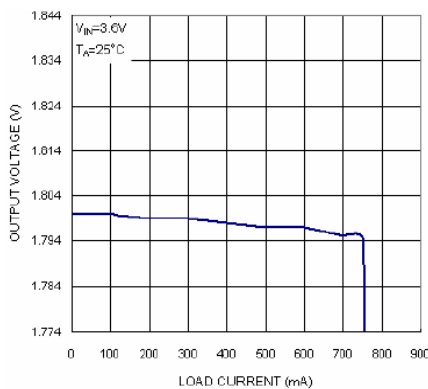

Fig. 8: Output Voltage vs Load Current

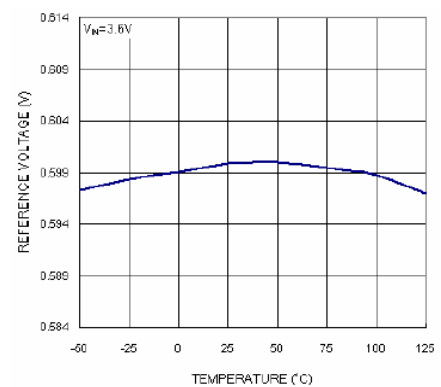
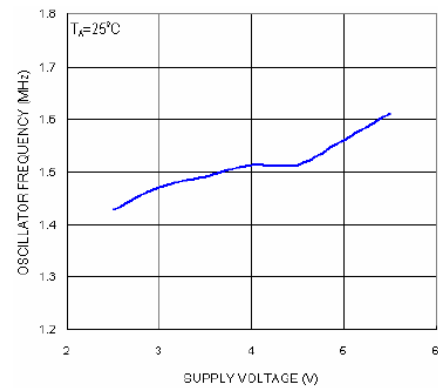
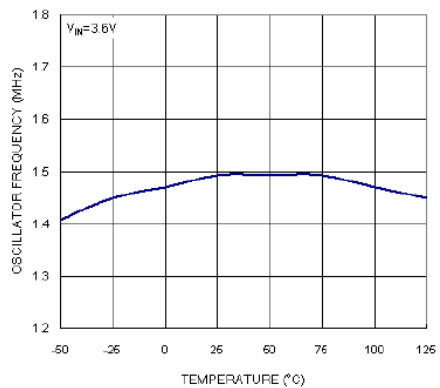
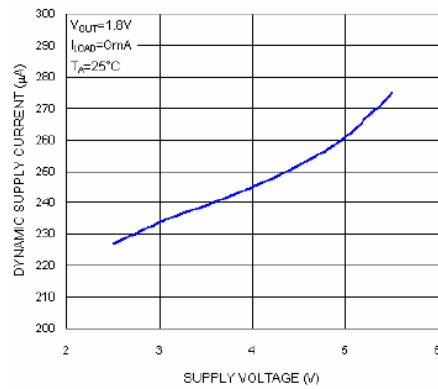
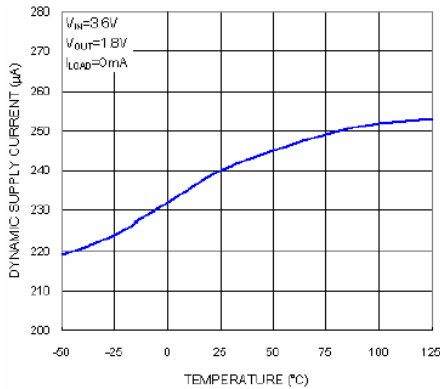
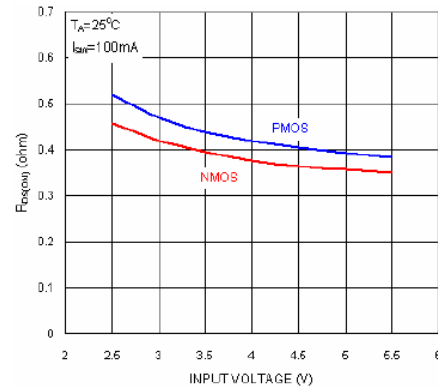
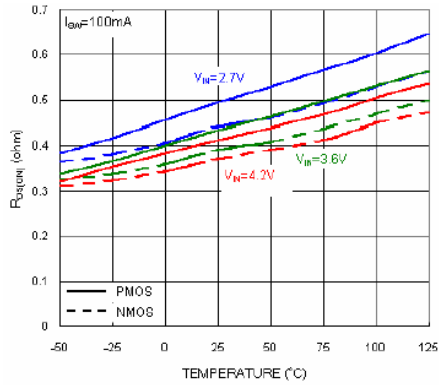

Fig. 9: Reference Voltage vs Temperature

600mA 1.5MHz Synchronous Step Down Converter



# 600mA 1.5MHz Synchronous Step Down Converter

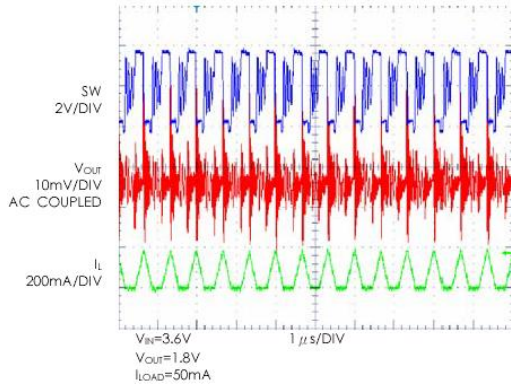

Fig. 16: Discontinuous Operation

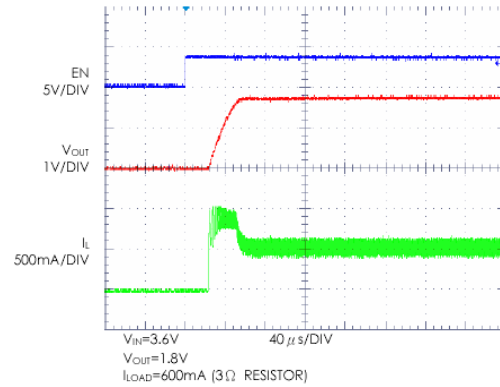

Fig. 17: Start-up from Shutdown

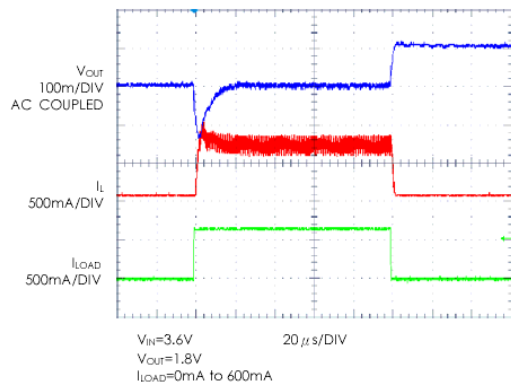

Fig. 18: Load Step

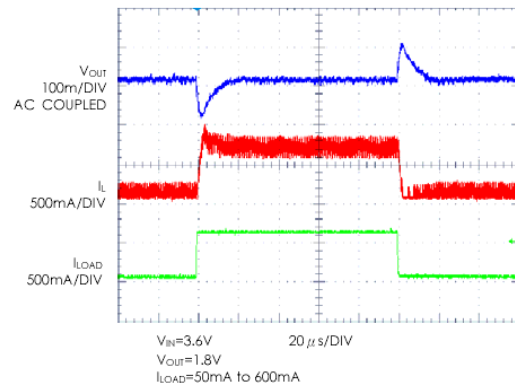

Fig. 19: Load Step

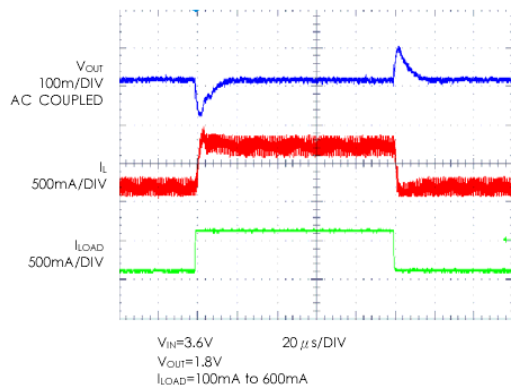

Fig. 20: Load Step

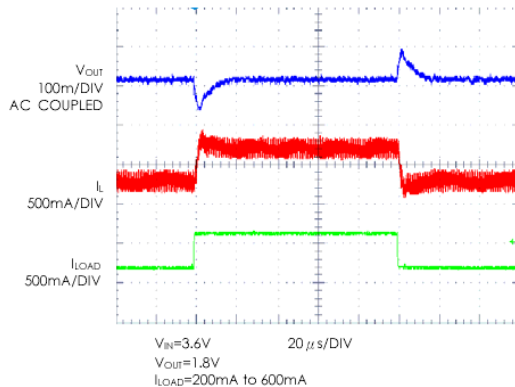

Fig. 21: Load Step

## 600mA 1.5MHz Synchronous Step Down Converter

### THEORY OF OPERATION

#### APPLICATIONS

The typical application circuit of the adjustable output voltage option and the fixed output voltage option are shown below.

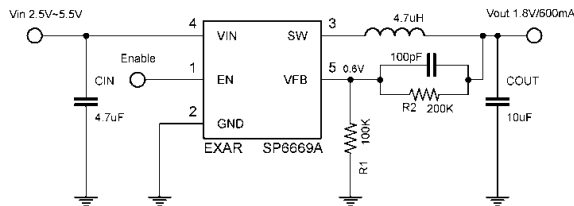

Fig. 22: Adjustable Output Voltage Version

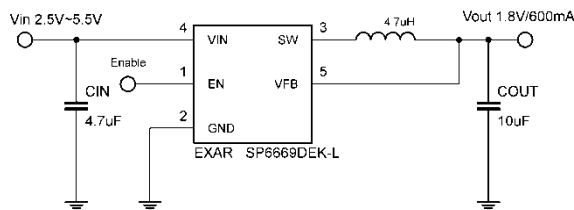

Fig. 23: Fixed Output Voltage Version

#### INDUCTOR SELECTION

Inductor ripple current and core saturation are two factors considered to select the inductor value.

$$\text{Eq. 1: } \Delta I_L = \frac{1}{f \cdot L} V_{OUT} \left( 1 - \frac{V_{OUT}}{V_{IN}} \right)$$

Equation 1 shows the inductor ripple current as a function of the frequency, inductance,  $V_{IN}$  and  $V_{OUT}$ . It is recommended to set the ripple current between 30% to 40% of the maximum load current. A low ESR inductor is preferred.

#### $C_{IN}$ AND $C_{OUT}$ SELECTION

A low ESR input capacitor can prevent large voltage transients at  $V_{IN}$ . The RMS current rating of the input capacitor is required to be larger than  $I_{RMS}$  calculated by:

$$\text{Eq. 2: } I_{RMS} \cong I_{OMAX} \frac{\sqrt{V_{OUT}(V_{IN} - V_{OUT})}}{V_{IN}}$$

The ESR rating of the capacitor is an important parameter to select  $C_{OUT}$ . The output ripple  $V_{OUT}$  is determined by:

$$\text{Eq. 3: } \Delta V_{OUT} \cong \Delta I_L \left( ESR + \frac{1}{8 \cdot f \cdot C_{OUT}} \right)$$

Higher values, lower cost ceramic capacitors are now available in smaller sizes. These capacitors have high ripple currents, high voltage ratings and low ESR that makes them ideal for switching regulator applications. As  $C_{OUT}$  does not affect the internal control loop stability, its value can be optimized to balance very low output ripple and circuit size. It is recommended to use an X5R or X7R rated capacitors which have the best temperature and voltage characteristics of all the ceramics for a given value and size.

#### OUTPUT VOLTAGE – ADJUSTABLE VERSION

The adjustable output voltage version is determined by:

$$\text{Eq. 4: } V_{OUT} = 0.6V \cdot \left( 1 + \frac{R_2}{R_1} \right)$$

#### THERMAL CONSIDERATIONS

Although the SP6669 has an on board over temperature circuitry, the total power dissipation it can support is based on the package thermal capabilities. The formula to ensure safe operation is given in note 1.

#### PCB LAYOUT

The following PCB layout guidelines should be taken into account to ensure proper operation and performance of the SP6669:

- 1- The GND, SW and  $V_{IN}$  traces should be kept short, direct and wide.
- 2-  $V_{FB}$  pin must be connected directly to the feedback resistors. The resistor divider network must be connected in parallel to the  $C_{OUT}$  capacitor.
- 3- The input capacitor  $C_{IN}$  must be kept as close as possible to the  $V_{IN}$  pin.



## 600mA 1.5MHz Synchronous Step Down Converter

4- The SW and VFB nodes should be kept as separate as possible to minimize possible effects from the high frequency and voltage swings of the SW node.

5- The ground plates of  $C_{IN}$  and  $C_{OUT}$  should be kept as close as possible.

### OUTPUT VOLTAGE RIPPLE FOR $V_{IN}$ CLOSE TO $V_{OUT}$

When the input voltage  $V_{IN}$  is close to the output voltage  $V_{OUT}$ , the SP6669 transitions smoothly from the switching PWM converter mode into a LDO mode. The following diagram shows the output voltage ripple versus the input voltage for a 3.3V output setting and a 200mA current load.

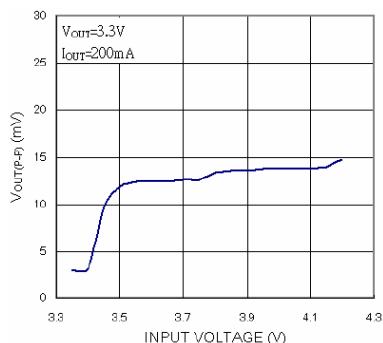

Fig. 24:  $V_{OUT}$  Ripple Voltage for  $V_{IN}$  decreasing close to  $V_{OUT}$

### DESIGN EXAMPLE

In a single Lithium-Ion battery powered application, the  $V_{IN}$  range is about 2.7V to 4.2V. The desired output voltage is 1.8V.

The inductor value needed can be calculated using the following equation

$$L = \frac{1}{f \cdot \Delta I_L} V_{OUT} \left( 1 - \frac{V_{OUT}}{V_{IN}} \right)$$

Substituting  $V_{OUT}=1.8V$ ,  $V_{IN}=4.2V$ ,  $\Delta I_L=180mA$  to 240mA (30% to 40%) and  $f=1.3MHz$  gives

$$L = 2.86\mu H \text{ to } 3.81\mu H$$

A 3.3 $\mu H$  inductor can be chosen with this application. An inductor of greater value with less equivalent series resistance would provide better efficiency. The  $C_{IN}$  capacitor requires an RMS current rating of at least  $I_{LOAD(MAX)}/2$  and low ESR. In most cases, a ceramic capacitor will satisfy this requirement.

600mA 1.5MHz Synchronous Step Down Converter

PACKAGE SPECIFICATION

5-PIN SOT23

Unit: mm

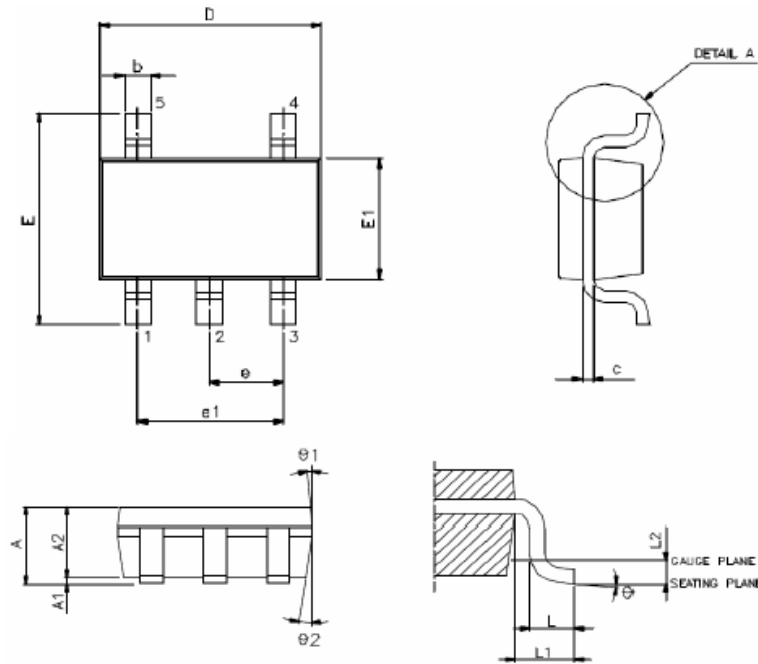

Symbol	Min.	Nom.	Max
A	0.90	1.30	1.40
A1	0.00	0.075	0.15
A2	0.90	1.20	1.25
b	0.30	-	0.50
c	0.08	-	0.20
D	2.80	2.90	3.00
E	2.60	2.80	3.00
E1	1.50	1.60	1.70
e	0.95 BSC		
e1	1.90 BSC		
L	0.30	0.45	0.60
L1	0.60 REF		
L2	0.25 BSC		
Ø	0	5	10
Ø1	3	5	7
Ø2	6	8	10

Note: JEDEC Outline MO-178 AA

## 600mA 1.5MHz Synchronous Step Down Converter

### REVISION HISTORY

Revision	Date	Description
2.0.0	07/15/2011	Reformat of datasheet Updated package specification
2.1.0	02/07/2012	Updated Typical Application schematics and Design example
2.2.0	11/08/2012	Reformat of datasheet (New logo) Updated Absolute Maximum Ratings, Lead Temperature (Soldering, 10 sec) to 260°C

### FOR FURTHER ASSISTANCE

Email:

[customersupport@exar.com](mailto:customersupport@exar.com)

[powertechsupport@exar.com](mailto:powertechsupport@exar.com)

Exar Technical Documentation:

<http://www.exar.com/TechDoc/default.aspx?>



### EXAR CORPORATION

#### HEADQUARTERS AND SALES OFFICES

48720 Kato Road

Fremont, CA 94538 – USA

Tel.: +1 (510) 668-7000

Fax: +1 (510) 668-7030

[www.exar.com](http://www.exar.com)

### NOTICE

EXAR Corporation reserves the right to make changes to the products contained in this publication in order to improve design, performance or reliability. EXAR Corporation assumes no responsibility for the use of any circuits described herein, conveys no license under any patent or other right, and makes no representation that the circuits are free of patent infringement. Charts and schedules contained here in are only for illustration purposes and may vary depending upon a user's specific application. While the information in this publication has been carefully checked; no responsibility, however, is assumed for inaccuracies.

EXAR Corporation does not recommend the use of any of its products in life support applications where the failure or malfunction of the product can reasonably be expected to cause failure of the life support system or to significantly affect its safety or effectiveness. Products are not authorized for use in such applications unless EXAR Corporation receives, in writing, assurances to its satisfaction that: (a) the risk of injury or damage has been minimized; (b) the user assumes all such risks; (c) potential liability of EXAR Corporation is adequately protected under the circumstances.

Reproduction, in part or whole, without the prior written consent of EXAR Corporation is prohibited.