



## FILTER - TUNABLE, BAND REJECT SMT 3.6 - 12.2 GHz

### Typical Applications

The HMC1000LP5E is ideal for:

- Test & Measurement Equipment
- Military RADAR & EW/ECM
- SATCOM & Space
- Industrial & Medical Equipment

### Features

- Tunable Stopband Frequency: 3.6-12.2 GHz
- Tunable Stopband Rejection: 25 dB Typical
- Four Frequency Control Modes
- Single Chip Replacement For Mechanically Tuned Designs
- 32 Lead 5 x 5 mm SMT Package

### Functional Diagram

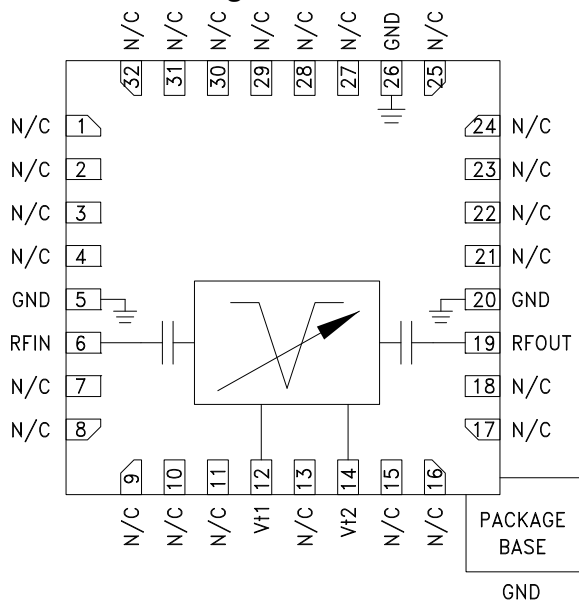

### General Description

The HMC1000LP5E is a MMIC band reject filter which features a user selectable band rejection frequency. The -20 dB filter bandwidth is < 10%. The rejection frequency can be varied between 3.6 and 12.2 GHz by applying an analog tune voltage between 0 and 14V. This tunable filter can be used as a much smaller SMT alternative to physically large switched filter banks and cavity tuned filters. The HMC1000LP5E has excellent microphonics due to the monolithic design, and provides a dynamically adjustable solution in advanced communications applications.

### Electrical Specifications, $T_A = +25\text{ }^\circ\text{C}$

Parameter	Min.	Typ.	Max.	Units
Rejection Band Tuning Range	3.6		12.2	GHz
Passband Frequency Range		0.1-25		GHz
Stopband Rejection		25		dB
Passband Insertion Loss		3		dB
Return Loss (passband and rejection band)		15		dB
Rejection Band Input IP3 (Pin = + 10 dBm)		23.5		dBm
Passband Input IP3 (Pin = + 10 dBm)		35		dBm
Input Power @ 5° Shift In Insertion Phase (Vt1 = Vt2 = 0V)		10		dBm
Input Power @ 5° Shift In Insertion Phase (Vt1 = Vt2 = 7V)		13		dBm
Input Power @ 5° Shift In Insertion Phase (Vt1 = Vt2 = 14V)		>18		dBm
Frequency Control Voltage (V <sub>ctl</sub> )	0		14	V
Source/Sink Current (I <sub>ctl</sub> )			±1	mA
Residual Phase Noise [1] (100 kHz Offset)		-162		dBc/Hz
Rejection Band, F <sub>center</sub> Drift Rate		-0.3		MHz/°C
Tuning Speed, Phase Settling to within 10° [2]		< 200		ns

[1] Optimum residual phase noise performance requires the use of a low noise driver circuit.

[2] Tuning speed includes 40 ns typical tuning voltage ramp from driver.

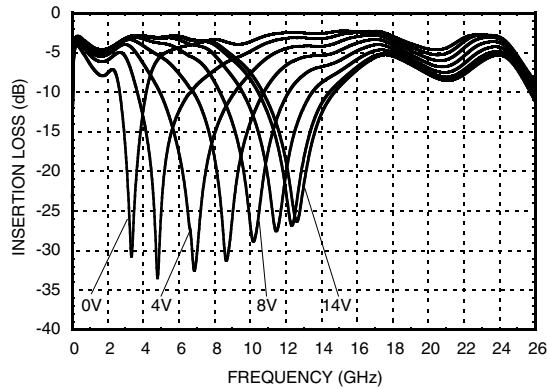
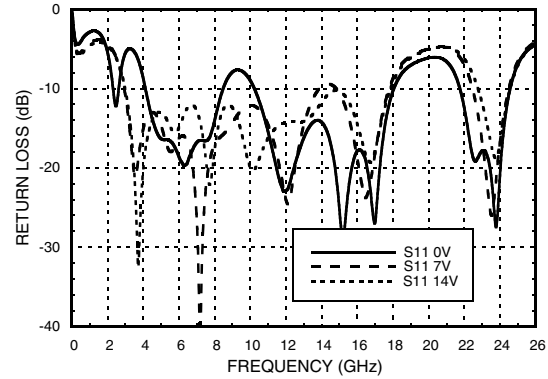
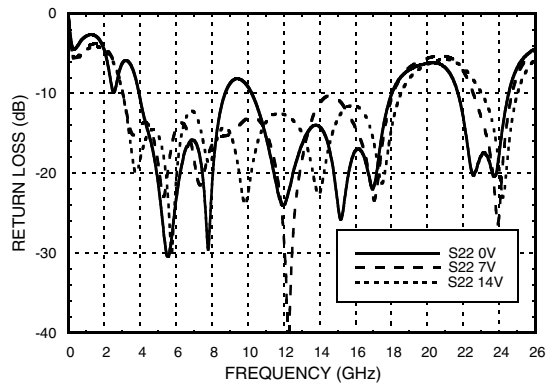
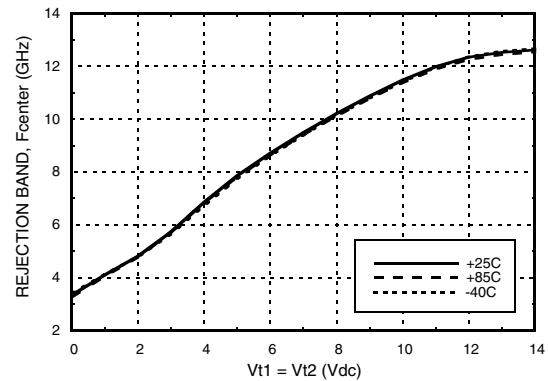
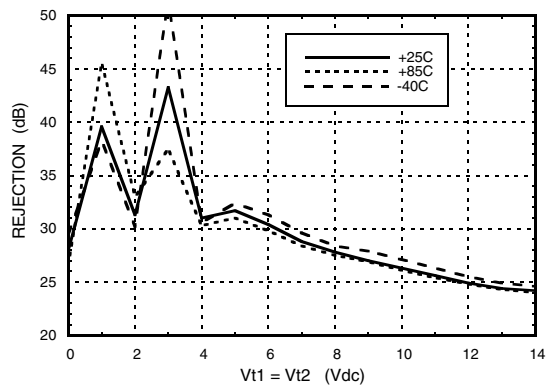
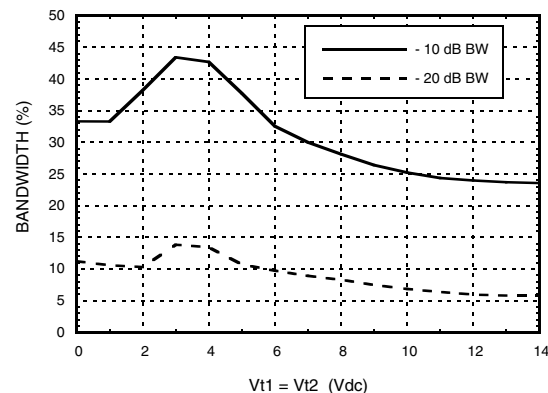

**FILTER - TUNABLE, BAND REJECT SMT**  
**3.6 - 12.2 GHz**
**Tuning Mode 1, Full Band Frequency Tuning, ( $V_{t1} = V_{t2} = 0-14V$ )**
**Broadband Insertion Loss vs.  $V_t$** 

**Broadband Return Loss ( $S_{11}$ ) vs.  $V_t$** 

**Broadband Return Loss ( $S_{22}$ ) vs.  $V_t$** 

**Rejection Band,  $F_{center}$  Vs. Temperature**

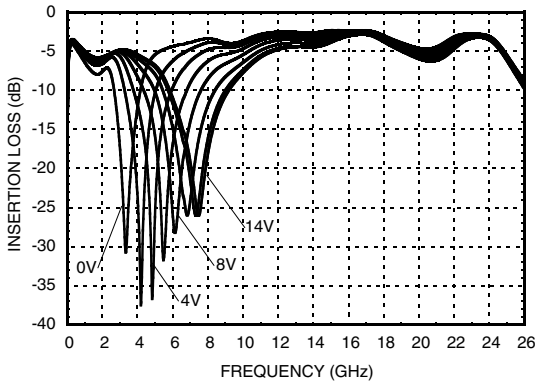
**Rejection Vs. Temperature**

**Rejection Bandwidth Vs.  $V_{t1} = V_{t2}$** 



## FILTER - TUNABLE, BAND REJECT SMT 3.6 - 12.2 GHz

Tuning Mode 2, Low Band Tuning With Narrower Rejection Bandwidth ( $V_{t1} = 0-14V$ ,  $V_{t2} = 0V$ )

**Broadband Insertion Loss vs.  $V_t$**



**Broadband return Loss (S11) vs.  $V_t$**

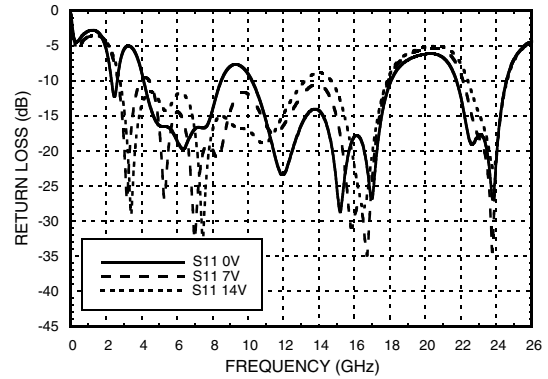

**Broadband Return Loss (S22) vs.  $V_t$**

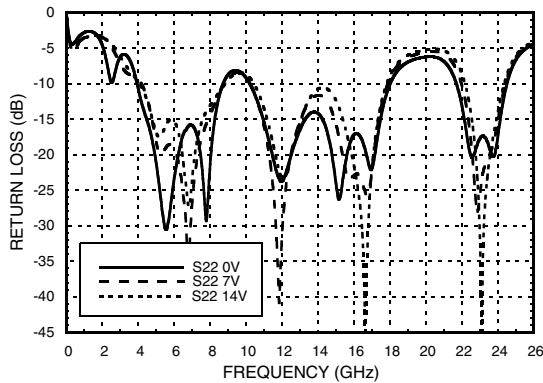

**Rejection Band,  $F_{center}$  Vs. Temperature**

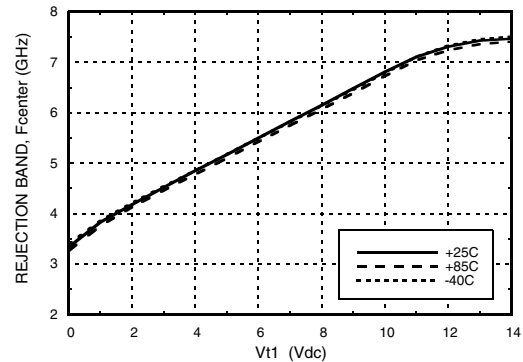

**Rejection Vs. Temperature**

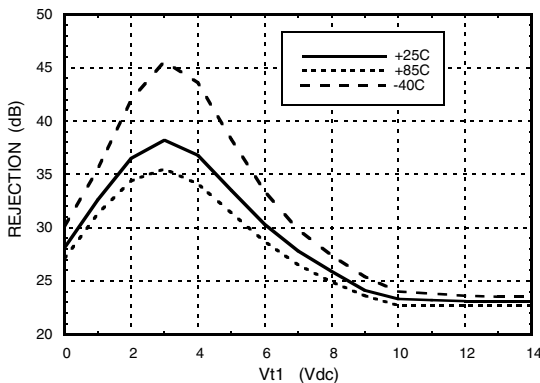

**Rejection Bandwidth Vs.  $V_{t1}$**

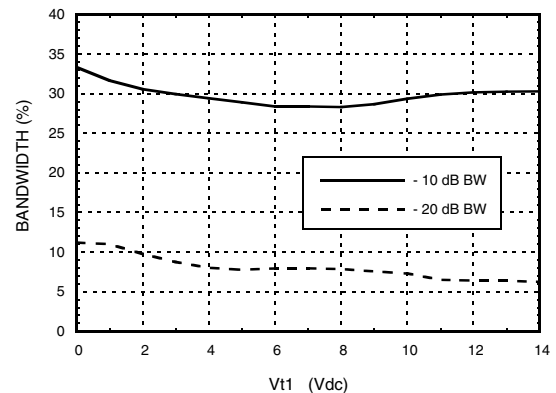



## FILTER - TUNABLE, BAND REJECT SMT 3.6 - 12.2 GHz

Tuning Mode 3, High Band Tuning With Narrower Rejection Bandwidth ( $Vt1 = 14V$ ,  $Vt2 = 0-14V$ )

**Broadband Insertion Loss vs.  $Vt$**

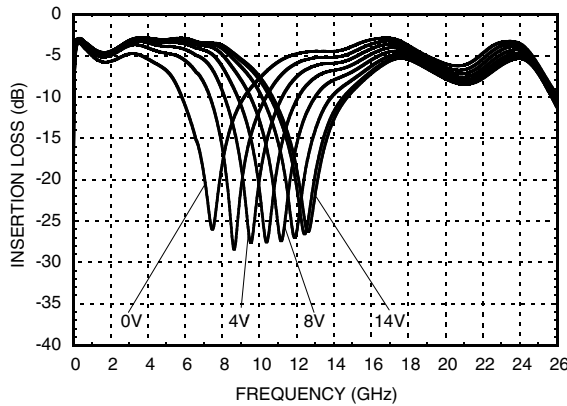

**Broadband return Loss (S11) vs.  $Vt$**

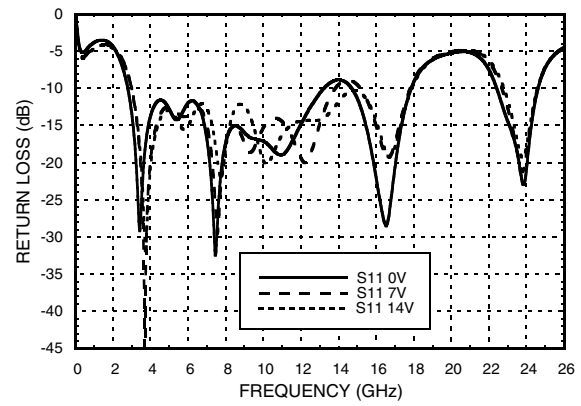

**Broadband Return Loss (S22) vs.  $Vt$**

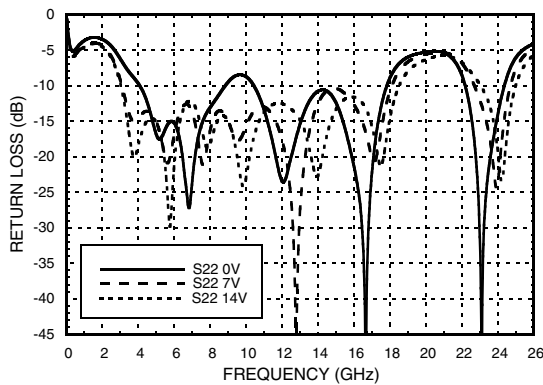

**Rejection Band,  $F_{center}$  Vs. Temperature**

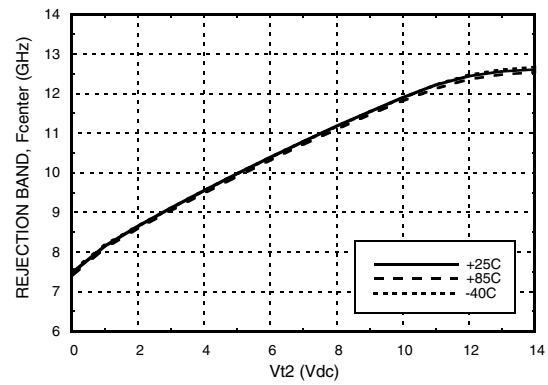

**Rejection Vs. Temperature**

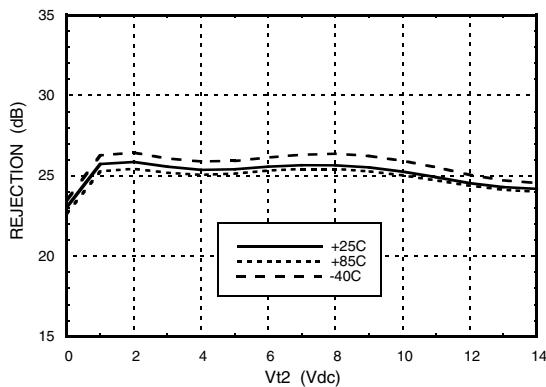

**Rejection Bandwidth Vs.  $Vt2$**

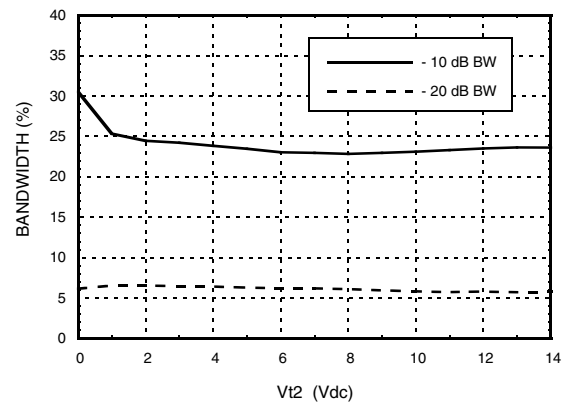

Tuning Mode 4, Rejection Bandwidth Tuning ( $Vt1 = 0V$ ,  $Vt2 = 0-14V$ )

**Broadband Insertion Loss vs.  $Vt$**

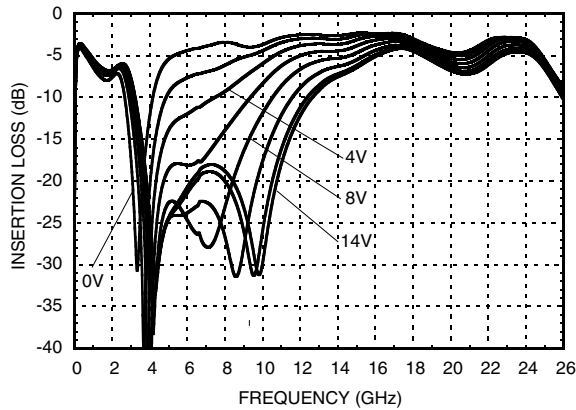

**Broadband Return Loss ( $S11$ ) vs.  $Vt$**

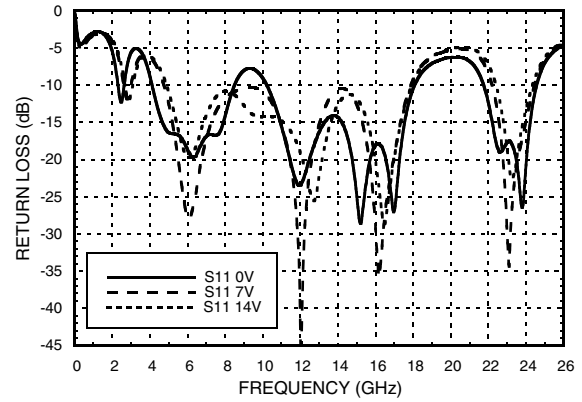

**Broadband return Loss ( $S22$ ) vs.  $Vt$**

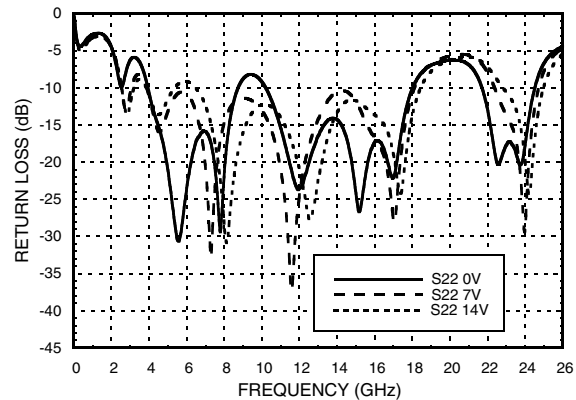

**Rejection Bandwidth Vs. Temperature  
Insertion Loss = - 10 dB**

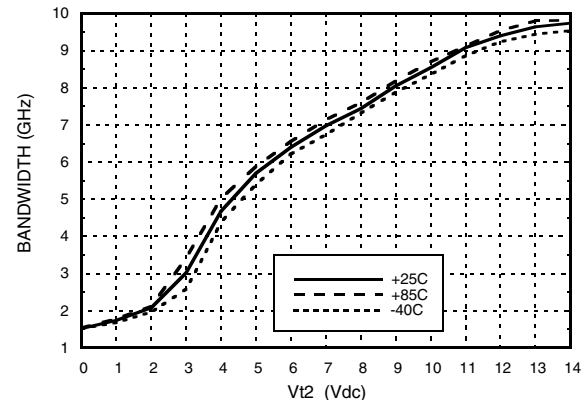

**Rejection Vs. Temperature,  $Vt2 = 14V$**

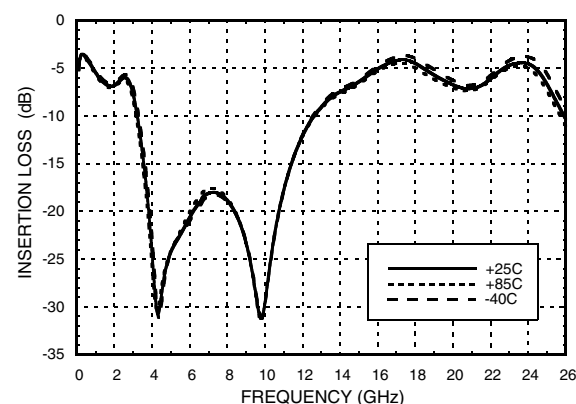

**Tuning Sensitivity Vs.  $Vt$**

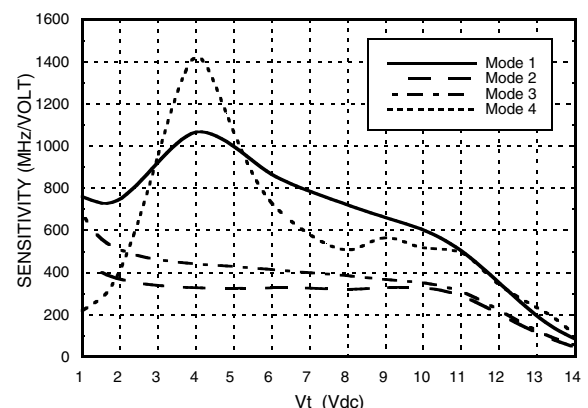



## FILTER - TUNABLE, BAND REJECT SMT 3.6 - 12.2 GHz

**Rejection Band, Input IP3,  
Pin = +10 dBm**

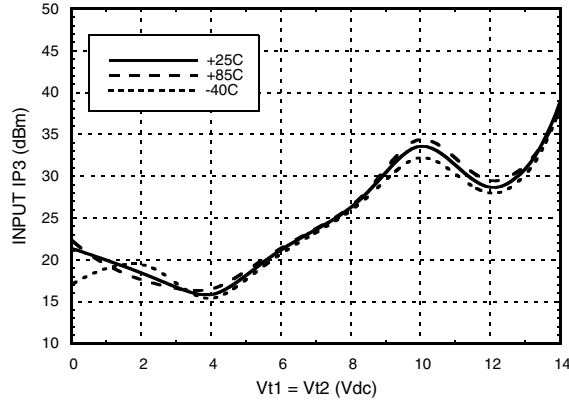

**Passband, Input IP3  
Pin = +10 dBm**

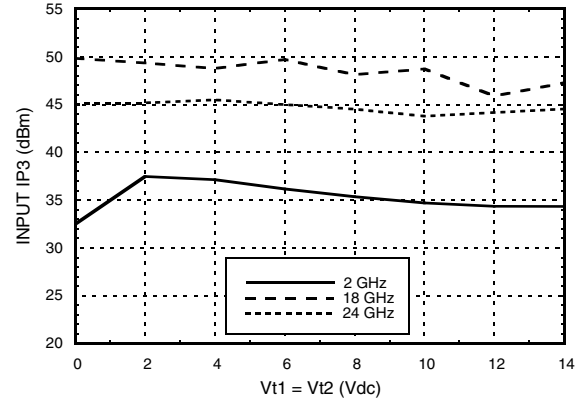

**Passband, Residual Phase Noise  
@ 4 GHz, Vt1 = Vt2 = 14V**

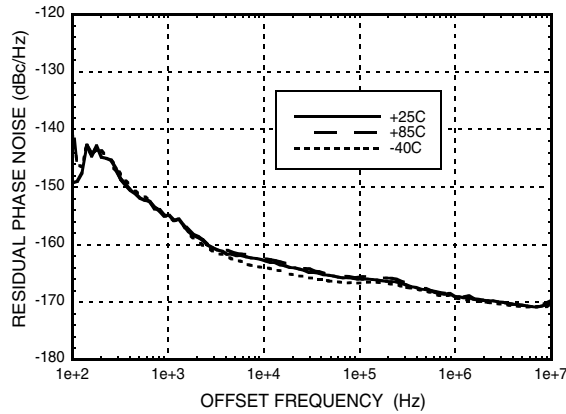

**Passband, Residual Phase Noise  
@ 17 GHz, Vt1 = Vt2 = 0V**

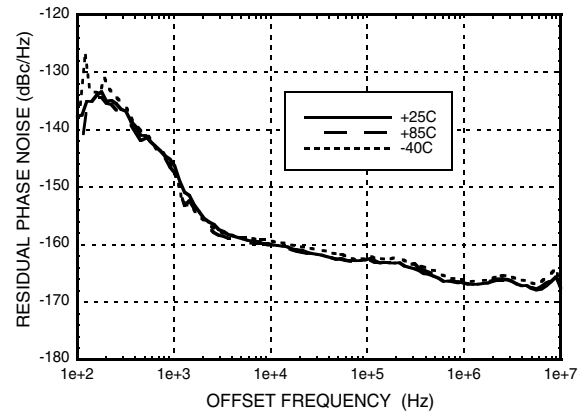

**Rejection Band, Insertion Phase vs. Pin**

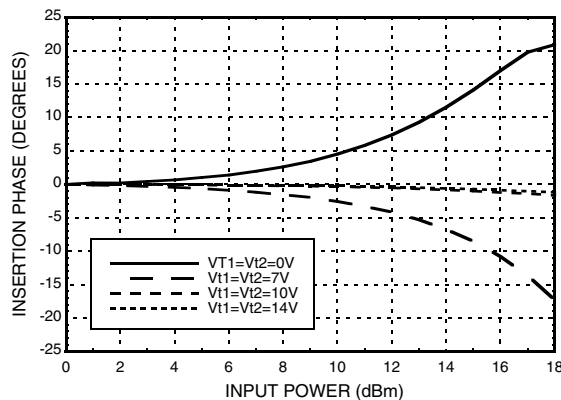

**Rejection Band, Fcenter vs. Pin**

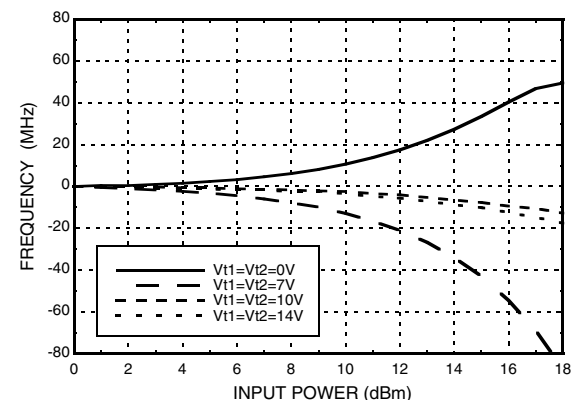

**FILTER - TUNABLE, BAND REJECT SMT  
3.6 - 12.2 GHz**
**Four Operation Modes And  
The Control Conditions**

Mode	Vt1	Vt2	Description
I	0 -14V Vt1 = Vt2	0 -14V Vt1 = Vt2	Full band frequency tuning
II	0 - 14V	0 V	Low band frequency tuning, with narrower rejection bandwidth
III	14V	0 - 14V	High band frequency tuning, with narrower rejection bandwidth
IV	0 V	0 - 14V	Rejection bandwidth tuning

**Reliability Information**

Junction Temperature to Maintain 1 Million Hour MTTF	150 °C
Nominal Junction Temperature (T = 85 °C and Pin = 10 dBm)	86 °C
Thermal Resistance (Junction To Ground Paddle)	40° C/W
Operating Temperature	-40 to +85 °C

**Absolute Maximum Ratings**

Frequency Control Voltage (Vfctl)	-0.5 to +15V
RF Power Input	28.5 dBm
Storage Temperature	-65 to +150 °C
ESD Sensitivity (HBM)	Class 1 A

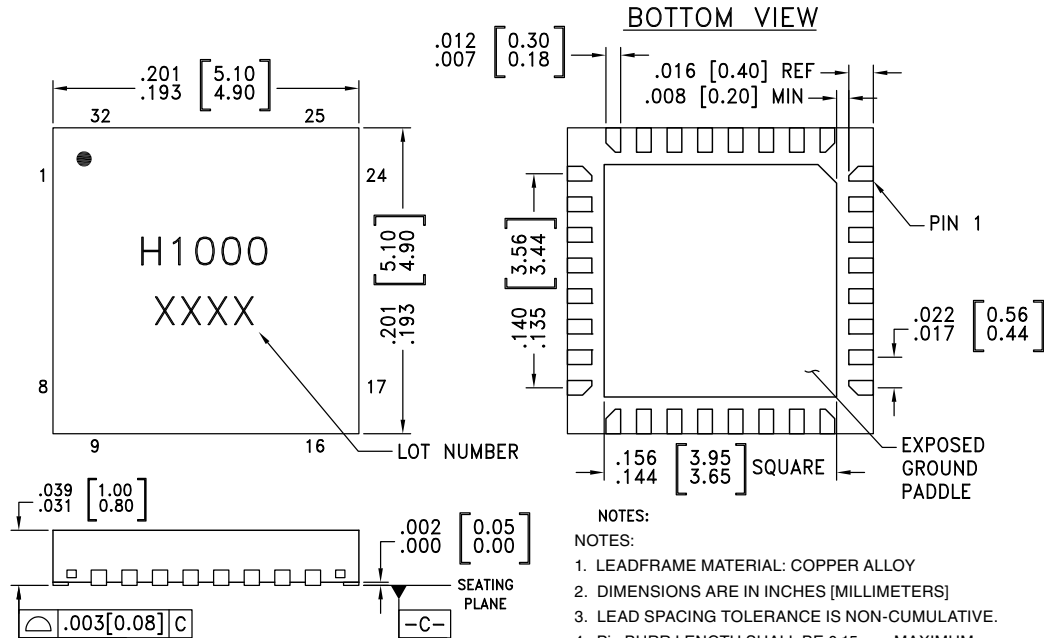

**ELECTROSTATIC SENSITIVE DEVICE  
OBSERVE HANDLING PRECAUTIONS**

**FILTER - TUNABLE, BAND REJECT SMT**  
**3.6 - 12.2 GHz**
**Outline Drawing**

**Package Information**

Part Number	Package Body Material	Lead Finish	MSL Rating	Package Marking <sup>[1]</sup>
HMC1000LP5E	RoHS-compliant Low Stress Injection Molded Plastic	100% matte Sn	MSL1 <sup>[2]</sup>	H1000 XXXX

[1] 4-Digit lot number XXXX

[2] Max peak reflow temperature of 260 °C





## FILTER - TUNABLE, BAND REJECT SMT 3.6 - 12.2 GHz

### Pin Descriptions

Pin Number	Function	Description	Interface Schematic
1-4, 7-11, 13, 15-18, 21-25, 27-32	N/C	The pins are not connected internally; however, all data shown herein was measured with these pins connected to RF/DC ground externally.	
5, 20, 26	GND	These pins and exposed paddle must be connected to RF/DC ground.	
6	RFIN	This pin is AC coupled and matched to 50 Ohms.	
12, 14	Vt1, Vt2	Center frequency control voltage.	
19	RFOUT	This pin is AC coupled and matched to 50 Ohms.	

### Application Circuit

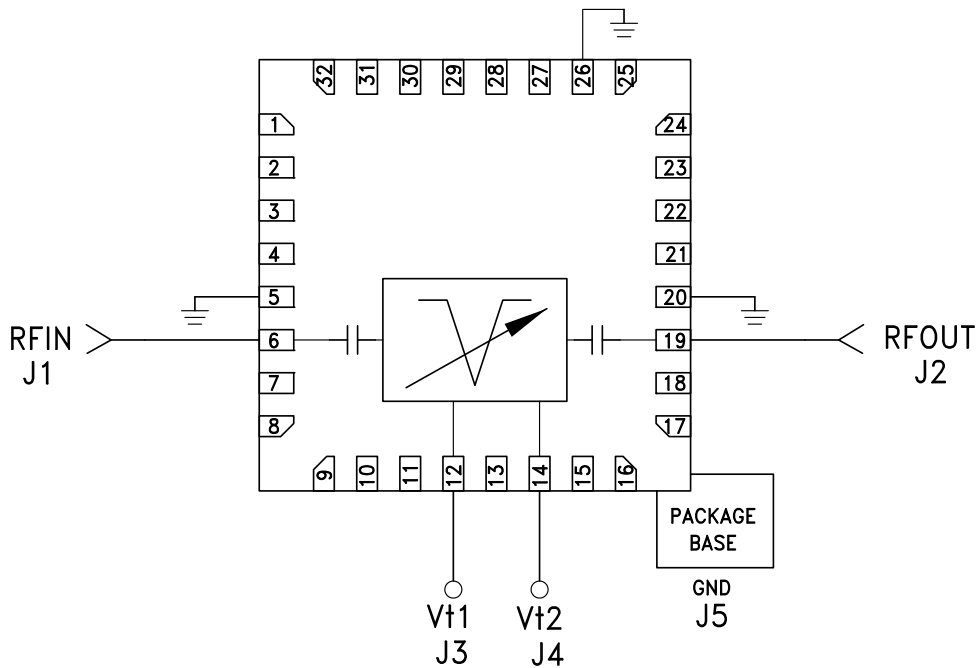

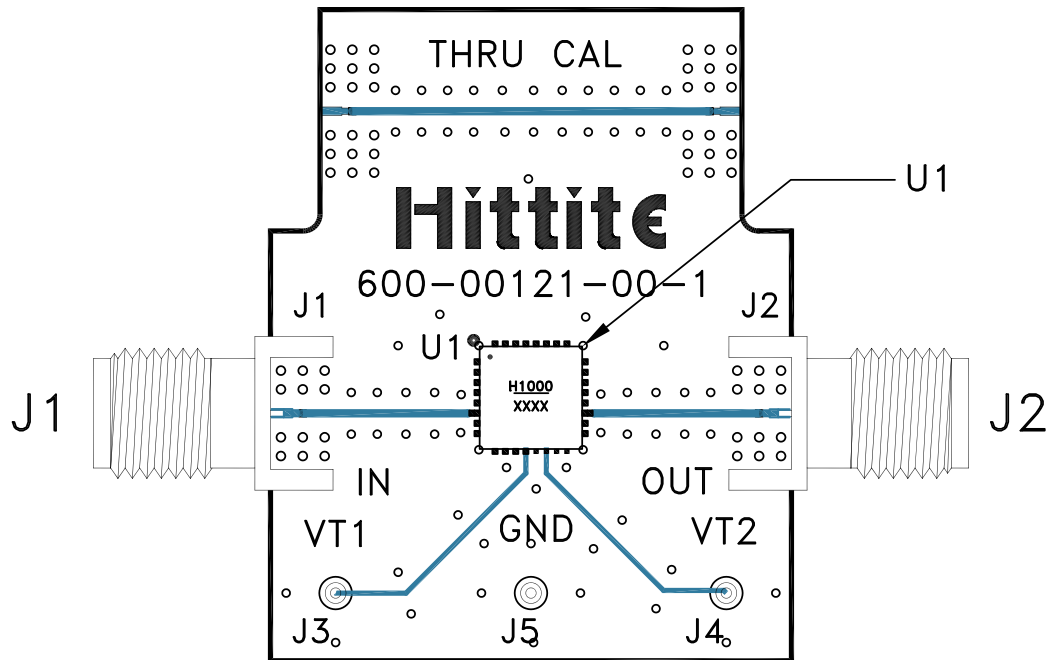
**Evaluation PCB**

**List of Materials for Evaluation PCB EVAL01-HMC1000LP5E [1]**

Item	Description
J1, J2	Connector, 2.9 mm, Jack
J3, J4, J5	DC Pin
U1	HMC1000LP5E, Band Reject Filter-Tunable
PCB [2]	600-00121-00 Evaluation PCB

[1] Reference this number when ordering complete evaluation PCB

[2] Circuit Board Material: Arlon 25FR or Rogers 25FR

The circuit board used in the application should use RF circuit design techniques. Signal lines should have 50 Ohms impedance while the package ground leads and exposed paddle should be connected directly to the ground plane similar to that shown. A sufficient number of via holes should be used to connect the top and bottom ground planes. The evaluation circuit board shown is available from Hittite upon request.