

## GaAs MMIC HERMETIC SMT VOLTAGE-VARIABLE ATTENUATOR, DC - 8 GHz

### Typical Applications

The HMC346G8 is ideal for:

- Basestation Infrastructure
- Fiber Optics & Broadband Telecom
- Microwave Radio & VSAT
- Military Radios, Radar, & ECM
- Test Instrumentation

### Features

- Wide Bandwidth: DC - 8 GHz
- Low Phase Shift vs. Attenuation
- 30 dB Attenuation Range
- 8 Lead Hermetic SMT Package

### Functional Diagram

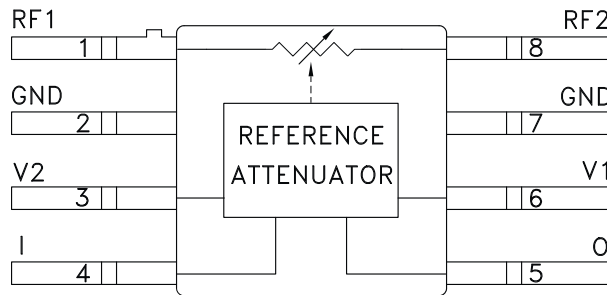

### General Description

The HMC346G8 is an absorptive Voltage Variable Attenuator (VVA) in an 8 lead glass / metal (hermetic) surface-mount package operating from DC - 8 GHz. It features an on-chip reference attenuator for use with an external op-amp to provide simple single voltage attenuation control, 0 to -3V. The device is ideal in designs where an analog DC control signal must control RF signal levels over a 30 dB amplitude range. Applications include AGC circuits and temperature compensation of multiple gain stages in microwave radios and test instrumentation.

### Electrical Specifications, $T_A = +25^\circ \text{C}$ , 50 ohm system

Parameter	Min	Typical	Max	Units
Insertion Loss		2.0	3.0	DC - 6 GHz
				DC - 8 GHz
Attenuation Range		30		dB
Return Loss	7	10		dB
Switching Characteristics		2		tRISE, tFALL (10/90% RF)
				tON, tOFF (50% CTL to 10/90% RF)
Input Power for 0.25 dB Compression (0.5 - 8 GHz)		+8		Min. Atten.
				-2
Input Third Order Intercept (0.5 - 8 GHz) (Two-tone Input Power = -8 dBm Each Tone)		+25		Min. Atten.
				+10

**GaAs MMIC HERMETIC SMT VOLTAGE-VARIABLE ATTENUATOR, DC - 8 GHz**

**Insertion Loss vs. Temperature**

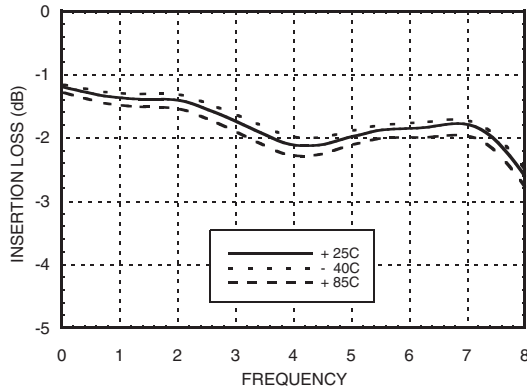

**Relative Attenuation, Control Voltage Optimized for 4 GHz Operation**

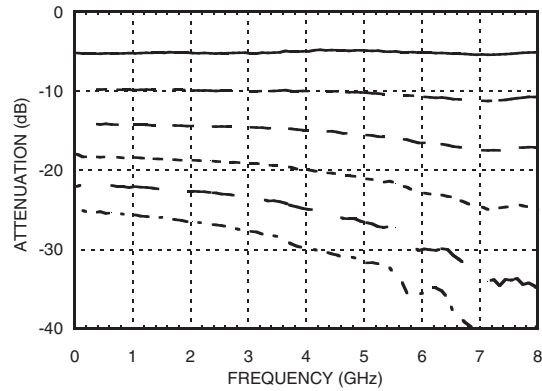

**Return Loss vs. Attenuation**

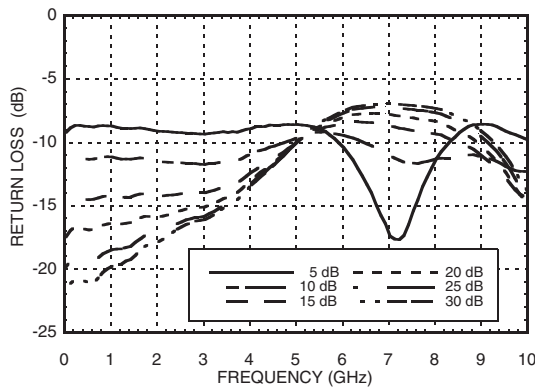

**Relative Attenuation, Control Voltage Optimized for 8 GHz Operation**

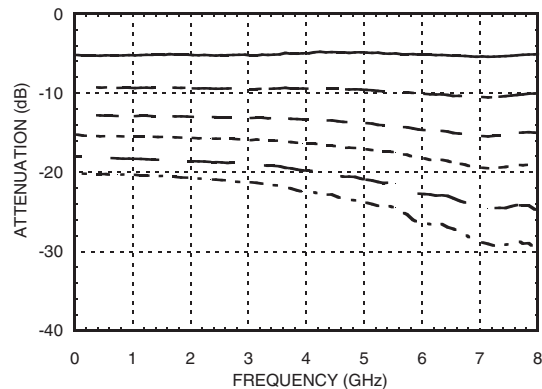

**Relative Attenuation vs. Control Voltage @ 4 GHz**

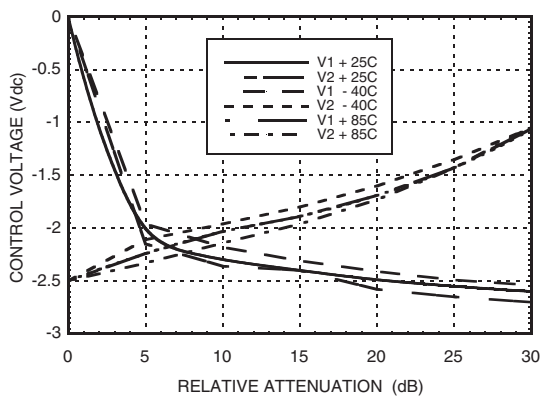

**Relative Attenuation vs. Control Voltage @ 8 GHz**

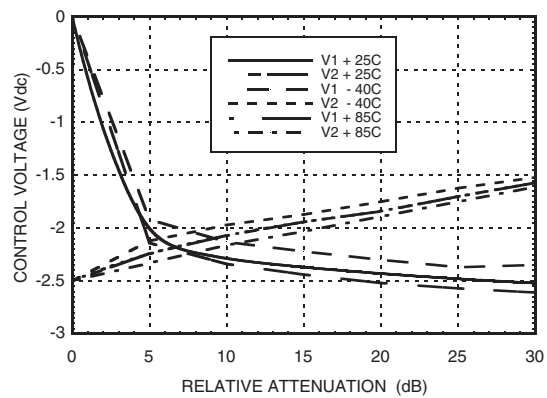

**GaAs MMIC HERMETIC SMT VOLTAGE-VARIABLE ATTENUATOR, DC - 8 GHz**

**Relative Phase**

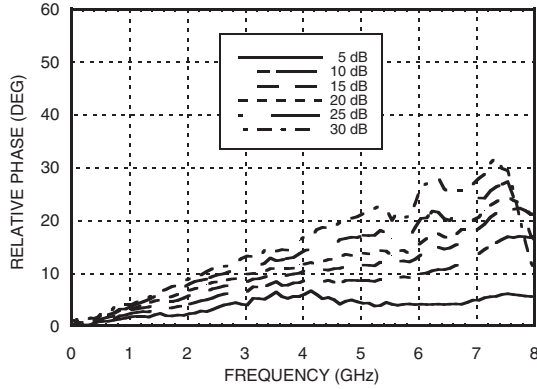

**Input Third Order Intercept vs. Attenuation\***

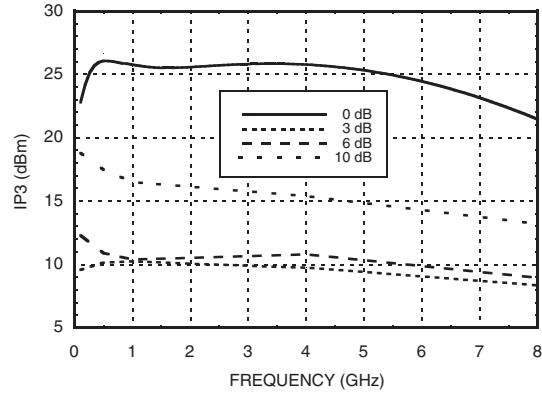

**Input Second Order Intercept vs. Attenuation\***

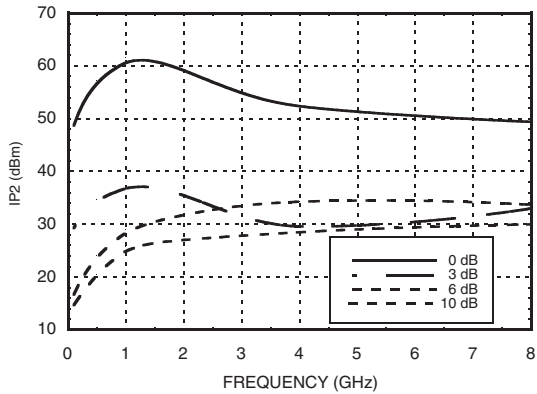

**Second Harmonic vs. Attenuation**

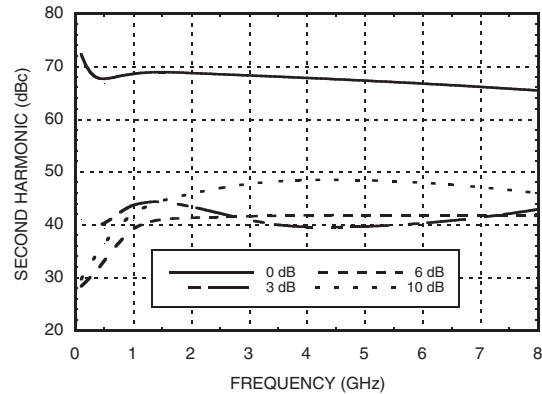

**0.25 dB Compression vs. Attenuation**

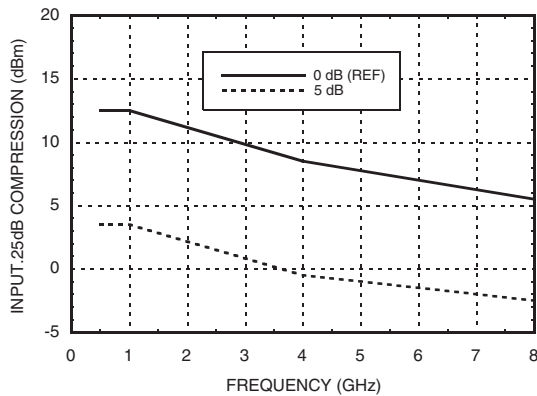

**1 dB Compression vs. Attenuation**

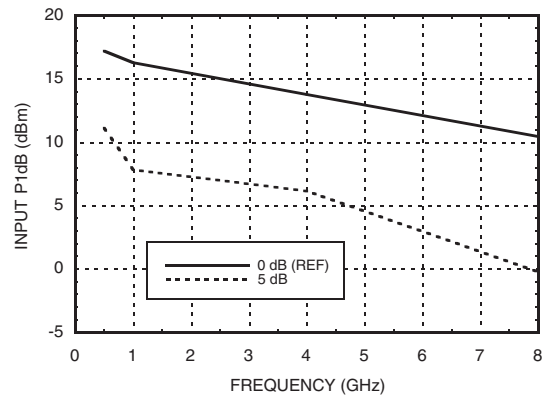

\*Two-tone input power = -8 dBm each tone.

**GaAs MMIC HERMETIC SMT VOLTAGE-VARIABLE ATTENUATOR, DC - 8 GHz**

**Absolute Maximum Ratings**

RF Input Power	+18 dBm
Control Voltage Range	+1 to -5V
Storage Temperature	-65 to +150 °C
Operating Temperature	-40 to +85 °C
ESD Sensitivity (HBM)	Class 1A



ELECTROSTATIC SENSITIVE DEVICE  
OBSERVE HANDLING PRECAUTIONS

**Outline Drawing**

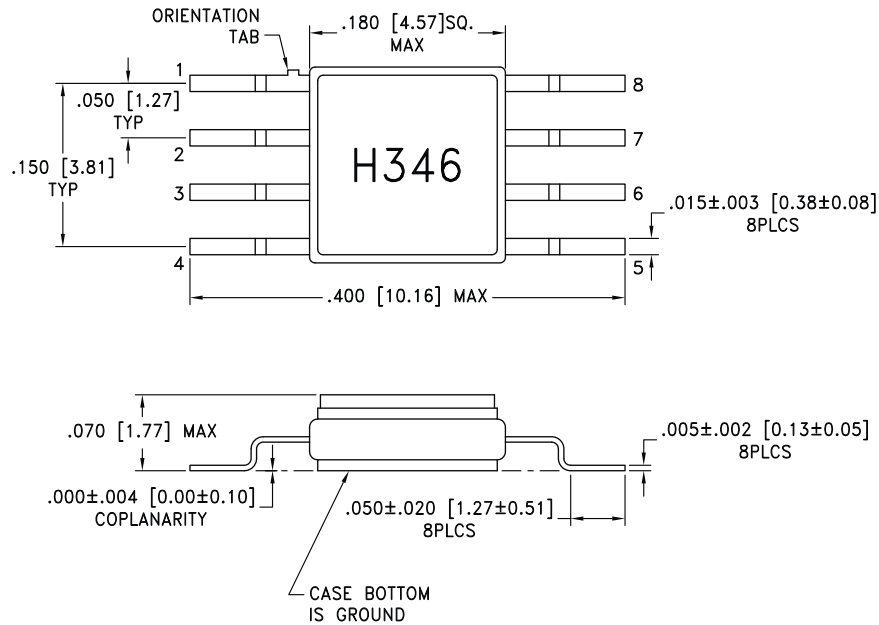

NOTES:



1. PACKAGE MATERIAL: ALUMINA LOADED BOROSILICATE GLASS.
2. LEAD, BASE, COVER MATERIAL: KOVAR™ (#7052 CORNING).
3. PLATING: ELECTROLYTIC GOLD 50 MICROINCHES MIN., OVER ELECTROLYTIC NICKEL 50 MICROINCHES MIN.
4. DIMENSIONS ARE IN INCHES [MILLIMETERS].
5. TOLERANCES:  $\pm .005 [0.13]$  UNLESS OTHERWISE SPECIFIED.
6. ALL GROUND LEADS AND GROUND PADDLE MUST BE SOLDERED TO PCB RF GROUND.

For price, delivery, and to place orders, please contact Hittite Microwave Corporation:  
20 Alpha Road, Chelmsford, MA 01824 Phone: 978-250-3343 Fax: 978-250-3373

Order On-Line at [www.hittite.com](http://www.hittite.com)  
**www.BDTIC.com/Hittite/**

## GaAs MMIC HERMETIC SMT VOLTAGE-VARIABLE ATTENUATOR, DC - 8 GHz

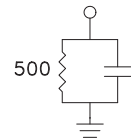
### Pin Descriptions

Pin Number	Function	Description	Interface Schematic
1, 8	RF1, RF2	This pin is DC coupled and matched to 50 Ohm. Blocking capacitors are required if RF line potential is not equal to 0V.	
2, 7	GND	This pin must be DC grounded.	
3, 6	V2, V1	Control Input (Master).	
4	I	Control Input (Slave).	
5	O	This pin must have an external 500 Ohm resistor to ground.	

### Single-Line Control Driver

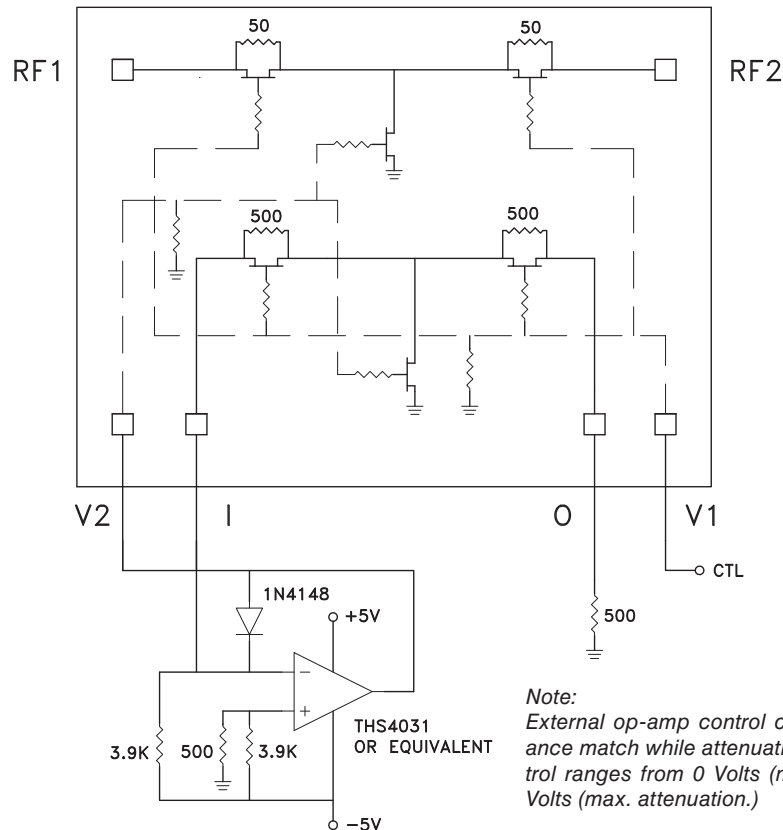

**GaAs MMIC HERMETIC SMT VOLTAGE-VARIABLE ATTENUATOR, DC - 8 GHz**

**Evaluation PCB**

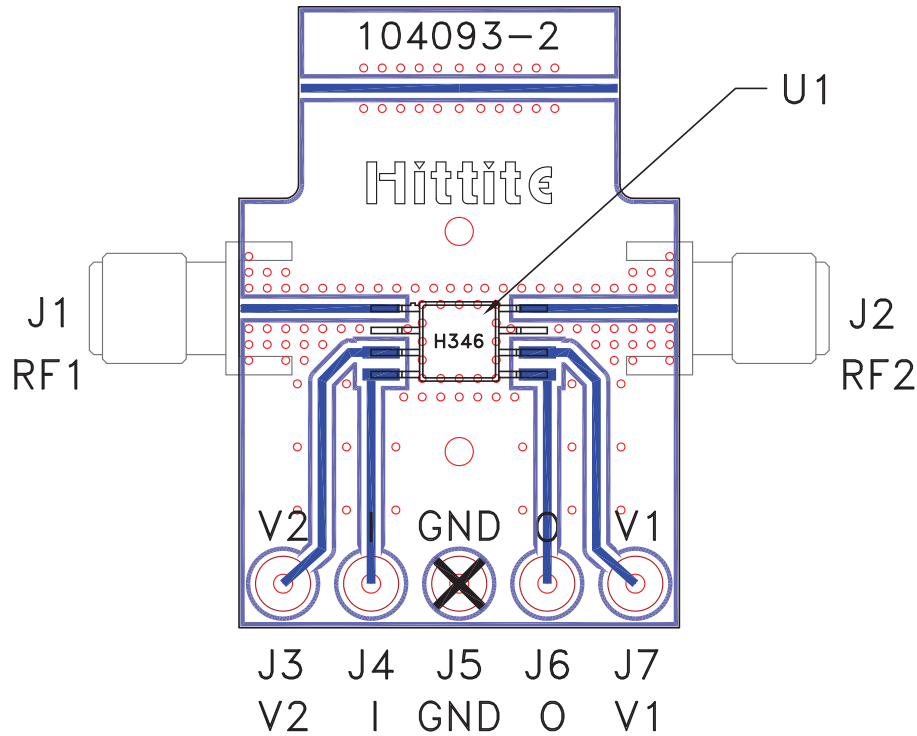

**List of Materials for Evaluation PCB 104095 [1]**

Item	Description
J1 - J2	PCB Mount SMA RF Connector
J3 - J7	DC PIN
U1	HMC346G8
PCB [2]	104093-2 Eval Board

[1] Reference this number when ordering complete evaluation PCB

[2] Circuit Board Material: Rogers 4350

The circuit board used in the final application should be generated with proper RF circuit design techniques. Signal lines at the RF ports should be 50 ohm impedance and the package ground leads and package bottom should be connected directly to the PCB RF ground plane, similar to that shown above. The evaluation circuit board shown above is available from Hittite Microwave Corporation upon request.