

Typical Applications

The HMC351S8 / HMC351S8E is ideal for:

- Cellular Basestations
- Cable Modems
- Fixed Wireless Access Systems

Features

- Conversion Loss: 9.0 dB
- LO/IF Isolation: 35 dB
- LO/RF Isolation: 42 dB
- Input IP3: +25 dBm
- Input IP2: +48 dBm

Functional Diagram

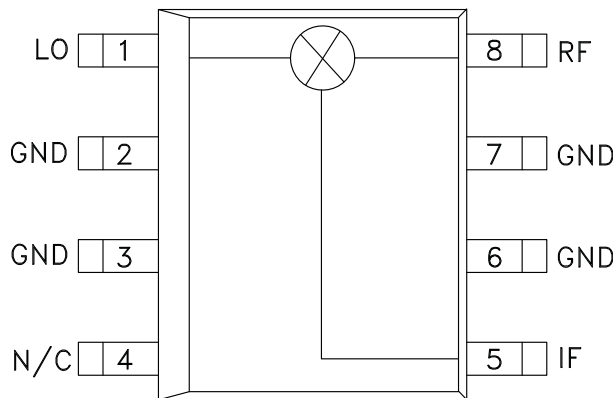

General Description

The HMC351S8 & HMC351S8E are double balanced mixers in 8 lead plastic surface mount packages. The passive GaAs schottky diode mixer implements planar on chip baluns and requires no external components. The mixer can be used as an upconverter, down converter, or modulator. The mixer provides 9 dB conversion loss and +25 dBm IIP3 with LO drive levels of +19 dBm. The design was optimized for low cost high volume applications where high converter linearity is required. The high LO suppression of 42 dB yields excellent carrier suppression for modulator applications.

Electrical Specifications, $T_A = +25^\circ C$

Parameter	LO = +19 dBm, IF = 100 MHz			Units
	Min.	Typ.	Max.	
Frequency Range, RF & LO	0.7 - 1.2			GHz
Frequency Range, IF	DC - 0.3			GHz
Conversion Loss		9	11.5	dB
Noise Figure (SSB)		9	11.5	dB
LO to RF Isolation	36	42		dB
LO to IF Isolation	31	35		dB
RF to IF Isolation	9	13		dB
IP3 (Input)	22	25		dBm
IP2 (Input)	40	48		dBm
1 dB Compression (Input)	12	16		dBm

*Unless otherwise noted, all measurements performed as downconverter, IF= 100 MHz.

For price, delivery, and to place orders, please contact Hittite Microwave Corporation:
 20 Alpha Road, Chelmsford, MA 01824 Phone: 978-250-3343 Fax: 978-250-3373

Order On-Line at www.hittite.com
www.BDTIC.com/Hittite/



GaAs MMIC HIGH IP3 DOUBLE-BALANCED MIXER, 0.7 - 1.2 GHz

Conversion Gain vs. Temperature @ LO = +19 dBm

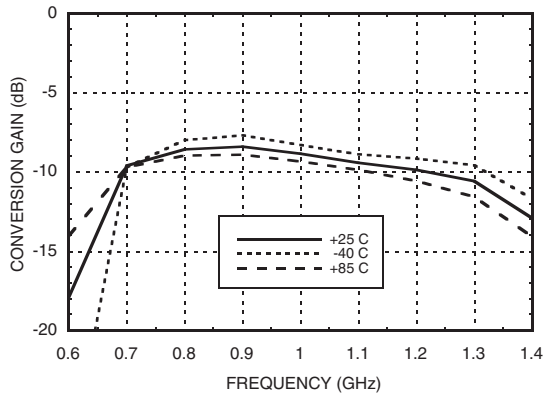

Isolation @ LO = +19 dBm

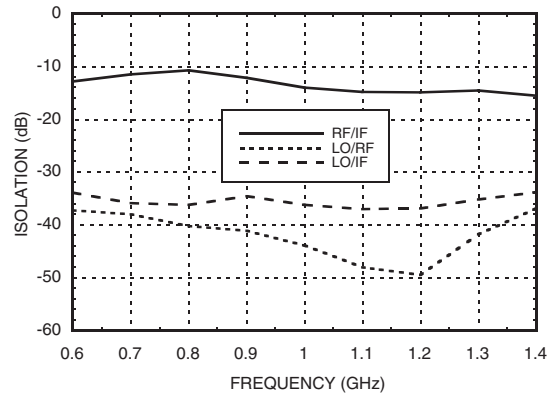

Conversion Gain vs. LO Drive

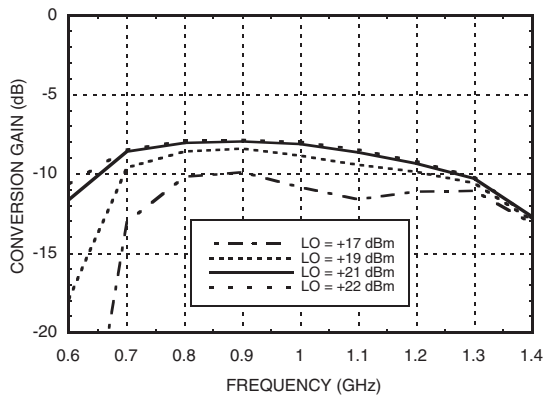

Return Loss @ LO = +19 dBm

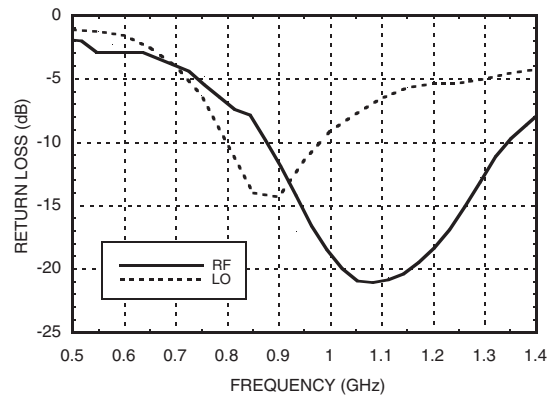

IF Bandwidth @ LO = +19 dBm

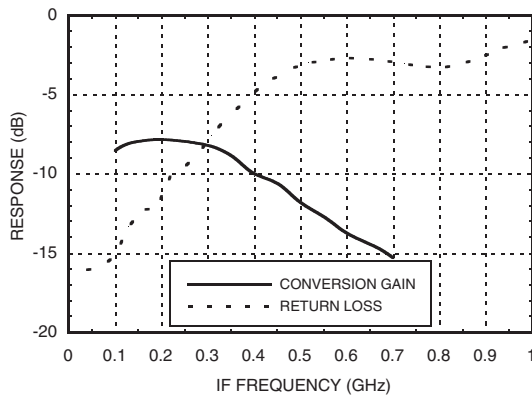

Upconverter Performance, Conversion Gain @ LO = +19 dBm

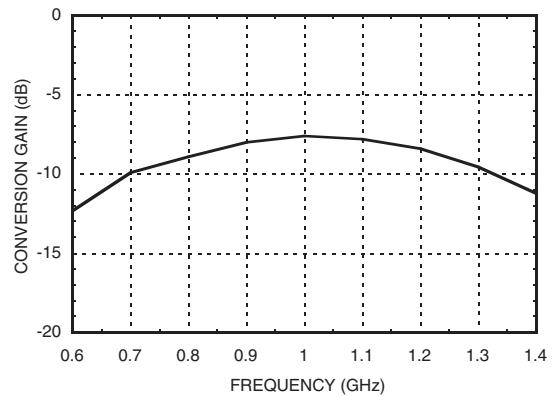



GaAs MMIC HIGH IP3 DOUBLE-BALANCED MIXER, 0.7 - 1.2 GHz

9

MIXERS - HIGH IP3 - SMT

Input IP3 vs. LO Drive *

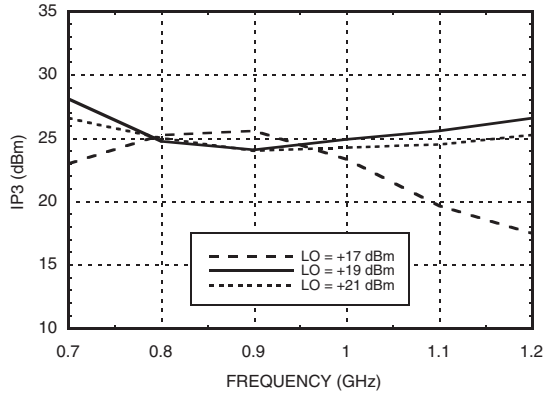

Input IP2 vs. LO Drive *

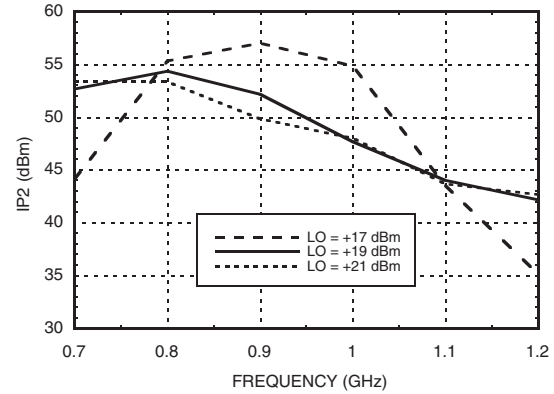

Input IP3 vs. Temperature *
@ LO Drive = +19 dBm

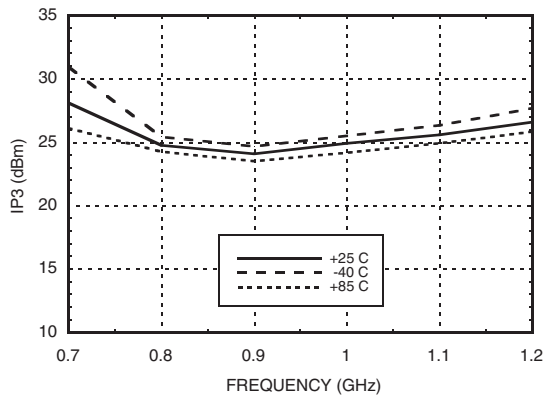

P1dB vs. Temperature *
@ LO = +19 dBm

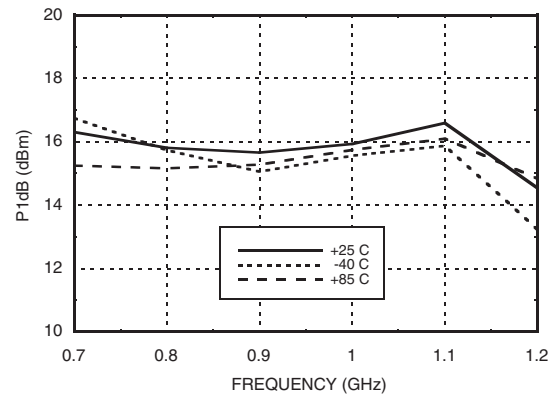

MxN Spurious Outputs

mRF	nLO				
	0	1	2	3	4
0	xx	-2	21	19	40
1	4	0	19	39	53
2	69	68	84	76	84
3	83	93	93	86	89
4	>96	>96	>96	>96	87

RF = 1.0 GHz @ -10 dBm
LO = 0.9 GHz @ +19 dBm
All values in dBc relative to the IF output power level.

Harmonics of LO

LO Frequency (GHz)	nLO Spur at RF Port			
	1	2	3	4
0.6	37	42	65	78
0.75	39	50	63	83
0.9	40	51	59	69
1.05	45	59	55	70
1.2	49	70	53	79
1.35	37	72	63	73

LO = +19 dBm
Values in dBc below input LO level measured at the RF port.

* Two-tone input power = 0 dBm each tone, 1 MHz spacing.

Absolute Maximum Ratings

RF / IF Input	+27 dBm
LO Drive	+27 dBm
Thermal Resistance (RTH) (junction to package bottom)	65 °C/W
Storage Temperature	-65 to +150 °C
Operating Temperature	-40 to +85 °C
IF DC Current	±26 mA
ESD Sensitivity (HBM)	Class 1A



ELECTROSTATIC SENSITIVE DEVICE
OBSERVE HANDLING PRECAUTIONS

Outline Drawing

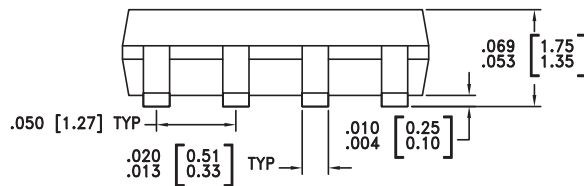
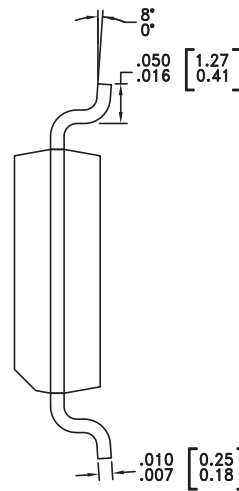
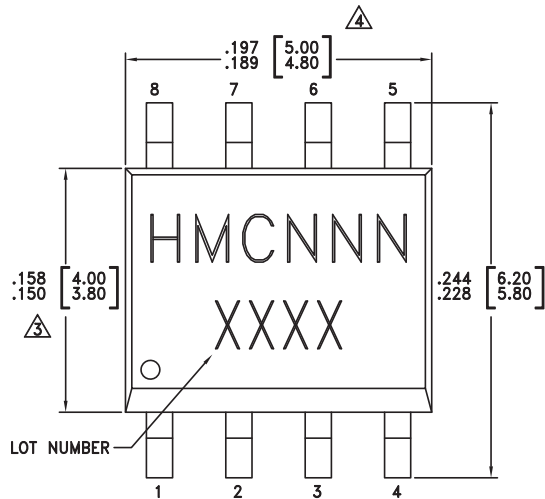

NOTES:

- LEADFRAME MATERIAL: COPPER ALLOY
- DIMENSIONS ARE IN INCHES [MILLIMETERS]
- $\triangle 3$ DIMENSION DOES NOT INCLUDE MOLDFLASH OF 0.15mm PER SIDE.
- $\triangle 4$ DIMENSION DOES NOT INCLUDE MOLDFLASH OF 0.25mm PER SIDE.
- ALL GROUND LEADS MUST BE SOLDERED TO PCB RF GROUND.

Package Information

Part Number	Package Body Material	Lead Finish	MSL Rating	Package Marking ^[3]
HMC351S8	Low Stress Injection Molded Plastic	Sn/Pb Solder	MSL1 ^[1]	HMC351 XXXX
HMC351S8E	RoHS-compliant Low Stress Injection Molded Plastic	100% matte Sn	MSL1 ^[2]	HMC351 XXXX

[1] Max peak reflow temperature of 235 °C

[2] Max peak reflow temperature of 260 °C

[3] 4-Digit lot number XXXX

For price, delivery, and to place orders, please contact Hittite Microwave Corporation:
20 Alpha Road, Chelmsford, MA 01824 Phone: 978-250-3343 Fax: 978-250-3373

Order On-Line at www.hittite.com
www.BDTC.com/Hittite/

Evaluation PCB

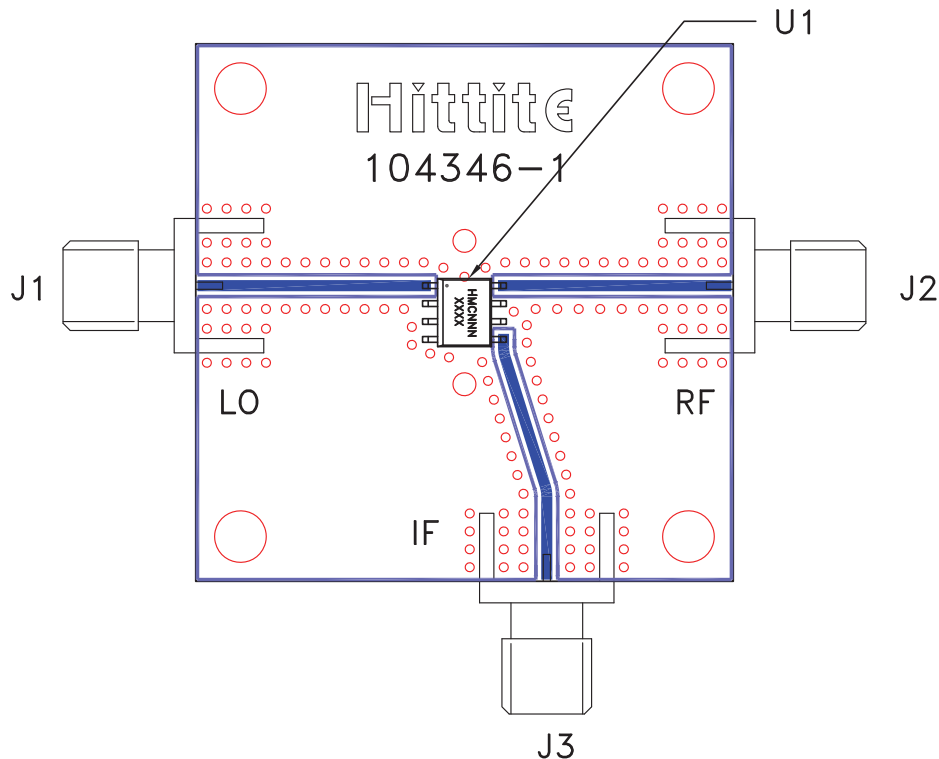

List of Materials for Evaluation PCB 104348 [1]

Item	Description
J1 - J3	PCB Mount SMA RF Connector
U1	HMC351S8 / HMC351S8E Mixer
PCB [2]	104346 Eval Board

[1] Reference this number when ordering complete evaluation PCB

[2] Circuit Board Material: Rogers 4350

The circuit board used in the final application should use RF circuit design techniques. Signal lines should have 50 ohm impedance while the package ground leads should be connected directly to the ground plane similar to that shown. A sufficient number of via holes should be used to connect the top and bottom ground planes. The evaluation circuit board as shown is available from Hittite upon request.



MICROWAVE CORPORATION v04.0408



HMC351S8 / 351S8E

GaAs MMIC HIGH IP3 DOUBLE-BALANCED MIXER, 0.7 - 1.2 GHz

Notes:

For price, delivery, and to place orders, please contact Hittite Microwave Corporation:
20 Alpha Road, Chelmsford, MA 01824 Phone: 978-250-3343 Fax: 978-250-3373

www.BDTIC.com/Hittite/