

GaAs PHEMT MMIC MEDIUM POWER AMPLIFIER, 6 - 18 GHz

Typical Applications

The HMC441 is ideal for:

- Point-to-Point and Point-to-Multi-Point Radios
- VSAT
- LO Driver for HMC Mixers
- Military EW & ECM

Features

- Gain: 15.5 dB
- Saturated Power: +22 dBm @ 23% PAE
- Single Supply Voltage:
+5V w/ Optional Gate Bias
- 50 Ohm Matched Input/Output
- Die Size: 0.94 x 0.94 x 0.1 mm

Functional Diagram

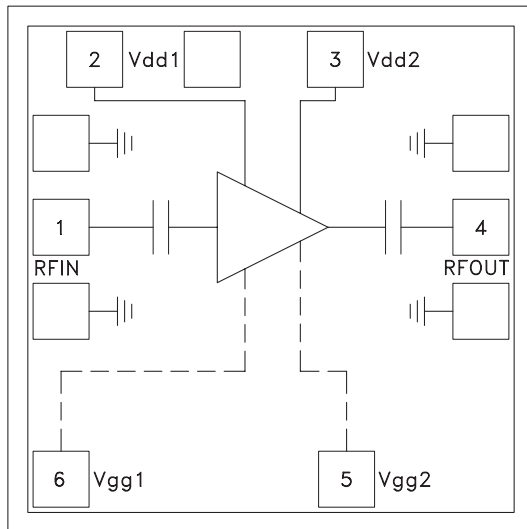

Vgg1, Vgg2: Optional Gate Bias

General Description

The HMC441 is an efficient GaAs PHEMT MMIC Medium Power Amplifier which operates between 6 and 18 GHz*. The amplifier provides 15.5 dB of gain, +22 dBm of saturated power, and 23% PAE from a +5V supply voltage. An optional gate bias is provided to allow adjustment of gain, RF output power, and DC power dissipation. The HMC441 amplifier can easily be integrated into Multi-Chip-Modules (MCMs) due to its small size. The backside of the die is both RF and DC ground, simplifying the assembly process and reducing performance variation. All data is tested with the chip in a 50 Ohm test fixture connected via 0.025mm (1 mil) diameter wire bonds of minimal length 0.31mm (12 mils).

Electrical Specifications, $T_A = +25^\circ\text{C}$, $V_{dd1} = V_{dd2} = 5\text{V}$, $V_{gg1} = V_{gg2} = \text{Open}$

Parameter	Min.	Typ.	Max.	Min.	Typ.	Max.	Min.	Typ.	Max.	Min.	Typ.	Max.	Units
Frequency Range	7.0 - 8.0			8.0 - 12.5			12.5 - 14.0			14.0 - 15.5			GHz
Gain	13	15.5		14	16.5		13	15.5		12	14.5		dB
Gain Variation Over Temperature		0.015	0.02		0.015	0.02		0.015	0.02		0.015	0.02	dB/°C
Input Return Loss		10			13			15			14		dB
Output Return Loss		14			17			23			18		dB
Output Power for 1 dB Compression (P1dB)	15.5	18.5		16	19		17	20		17	20		dBm
Saturated Output Power (Psat)	17	20		18	21		19	22		19	22		dBm
Output Third Order Intercept (IP3)		29			31			32			32		dBm
Noise Figure		5.0			4.5			4.5			4.5		dB
Supply Current (Idd)		90	115		90	115		90			90	115	mA

*Contact HMC for Electrical Spec Limits for 6-7 & 15.5 - 18 GHz.

For price, delivery, and to place orders, please contact Hittite Microwave Corporation:
20 Alpha Road, Chelmsford, MA 01824 Phone: 978-250-3343 Fax: 978-250-3373

Order Online at www.hittite.com
www.BDTIC.com/Hittite/

GaAs PHEMT MMIC MEDIUM POWER AMPLIFIER, 6 - 18 GHz

Broadband Gain & Return Loss

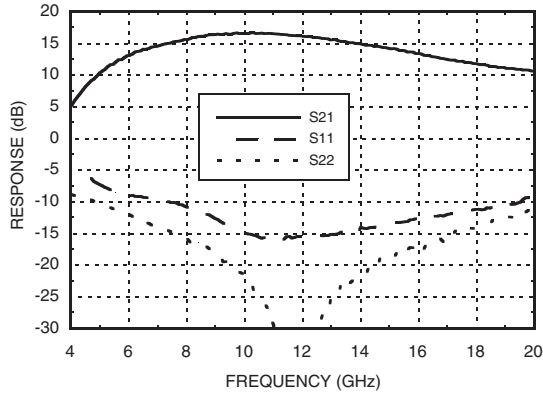

Gain vs. Temperature

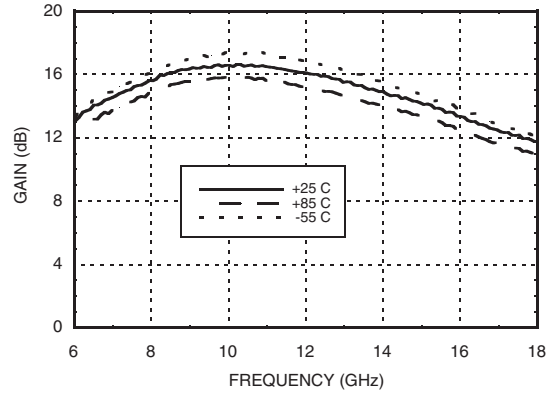

Input Return Loss vs. Temperature

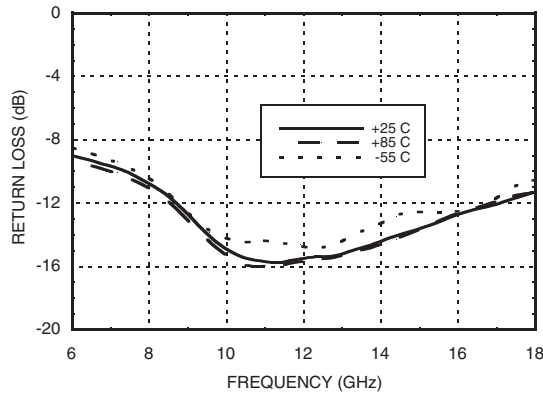

Output Return Loss vs. Temperature

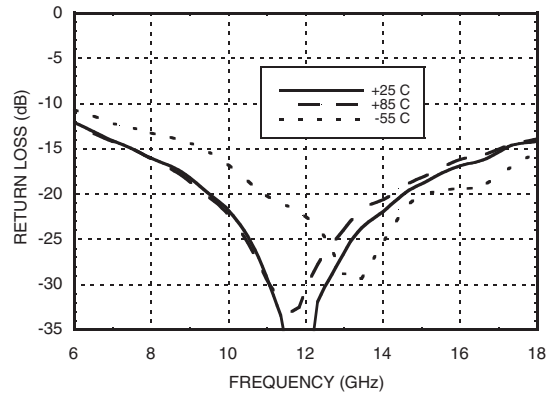

P1dB vs. Temperature

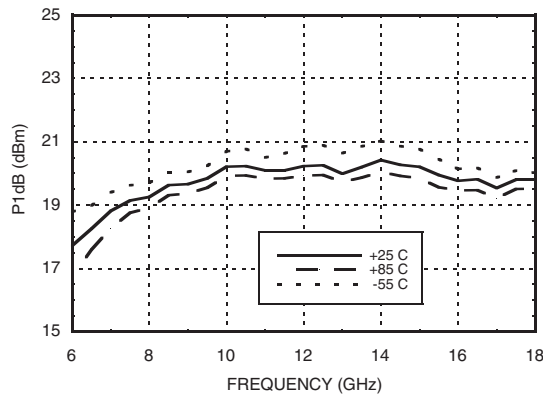

Psat vs. Temperature

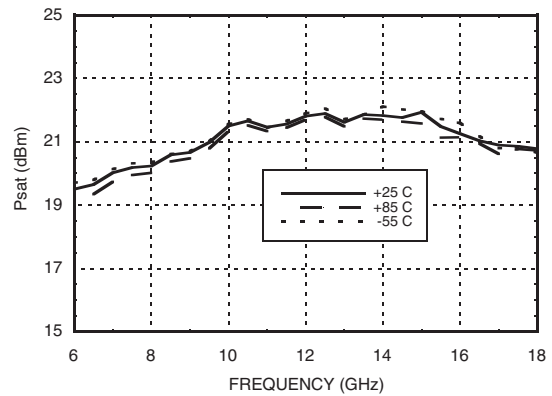

GaAs PHEMT MMIC MEDIUM POWER AMPLIFIER, 6 - 18 GHz

Power Compression @ 11 GHz

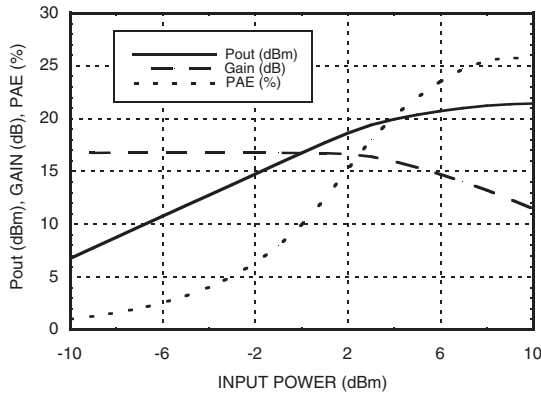

Power Compression @ 15 GHz

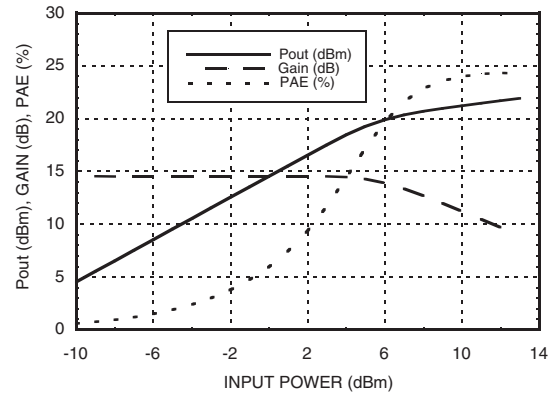

Output IP3 vs. Temperature

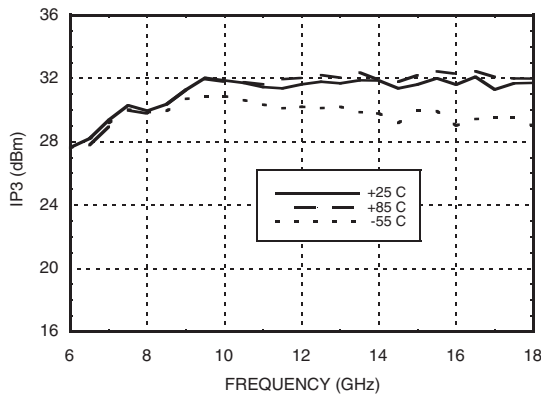

Noise Figure vs. Temperature

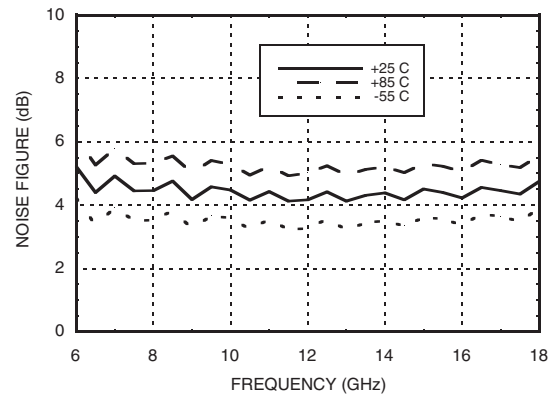

Gain & Power vs. Supply Voltage @ 11 GHz

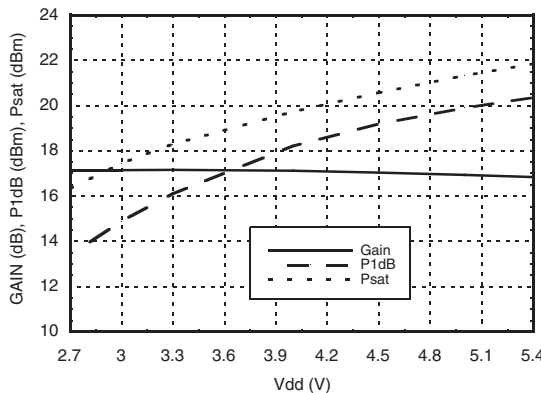

Reverse Isolation vs. Temperature

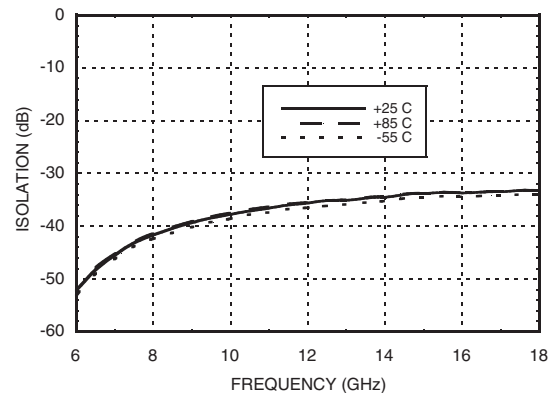

GaAs PHEMT MMIC MEDIUM POWER AMPLIFIER, 6 - 18 GHz

Gain, Power & Output IP3 vs. Gate Voltage @ 12 GHz

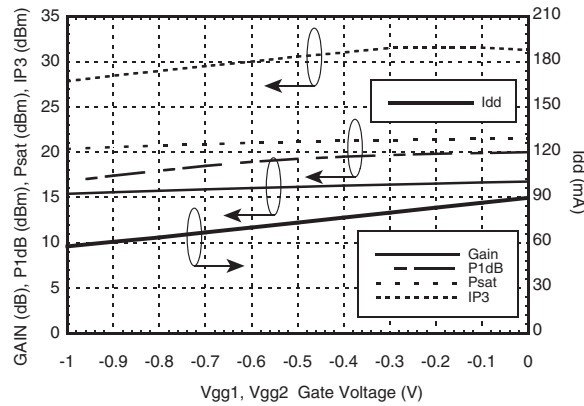

Absolute Maximum Ratings

Drain Bias Voltage (Vdd1, Vdd2)	+5.5 Vdc
Gate Bias Voltage (Vgg1,Vgg2)	-8 to 0 Vdc
RF Input Power (RFIN)(Vdd = +5Vdc)	+20 dBm
Channel Temperature	175 °C
Continuous Pdiss (T= 85 °C) (derate 8.5 mW/°C above 85 °C)	0.76 W
Thermal Resistance (channel to die bottom)	118 °C/W
Storage Temperature	-65 to +150 °C
Operating Temperature	-55 to +85 °C

Typical Supply Current vs. Vdd

Vdd (V)	Idd (mA)
+4.5	88
+5.0	90
+5.5	92
+2.7	80
+3.0	82
+3.3	83

Note: Amplifier will operate over full voltage ranges shown above



**ELECTROSTATIC SENSITIVE DEVICE
OBSERVE HANDLING PRECAUTIONS**

GaAs PHEMT MMIC MEDIUM POWER AMPLIFIER, 6 - 18 GHz

Outline Drawing

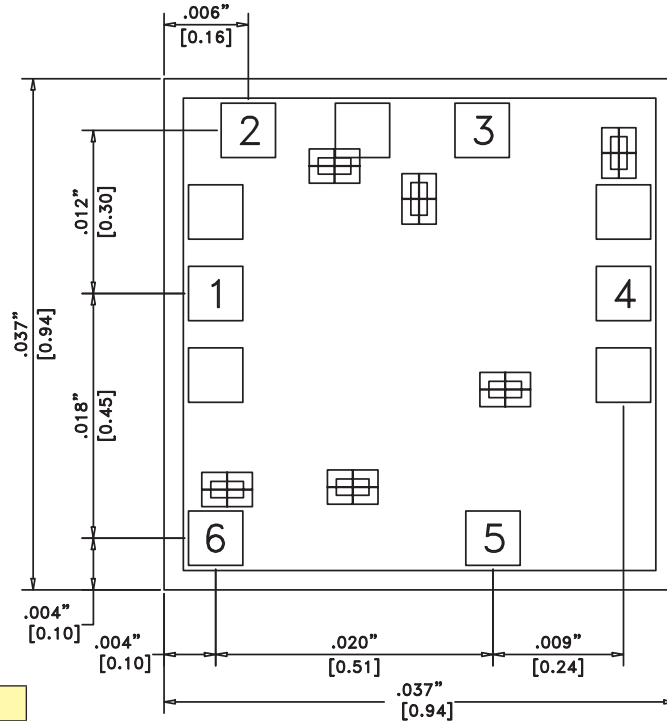

NOTES:

1. ALL DIMENSIONS ARE IN INCHES [MM]
2. DIE THICKNESS IS .004"
3. TYPICAL BOND IS .004" SQUARE
4. BACKSIDE METALLIZATION: GOLD
5. BOND PAD METALLIZATION: GOLD
6. BACKSIDE METAL IS GROUND.
7. CONNECTION NOT REQUIRED FOR UNLABELED BOND PADS.

Die Packaging Information [1]

Standard	Alternate
GP-2 (Gel Pack)	[2]

[1] Refer to the "Packaging Information" section for die packaging dimensions.

[2] For alternate packaging information contact Hittite Microwave Corporation.

Pad Descriptions

Pad Number	Function	Description	Interface Schematic
1	RFIN	This pad is AC coupled and matched to 50 Ohms.	
2, 3	Vdd1, Vdd2	Power Supply Voltage for the amplifier. An external bypass capacitor of 100 pF is required.	
4	RFOUT	This pad is AC coupled and matched to 50 Ohms.	
5, 6	Vgg1, Vgg2	Optional gate control for amplifier. If left open, the amplifier will run at standard current. Negative voltage applied will reduce current.	

**GaAs PHEMT MMIC MEDIUM
POWER AMPLIFIER, 6 - 18 GHz**

(a) Assembly for Single Supply Voltage Operation

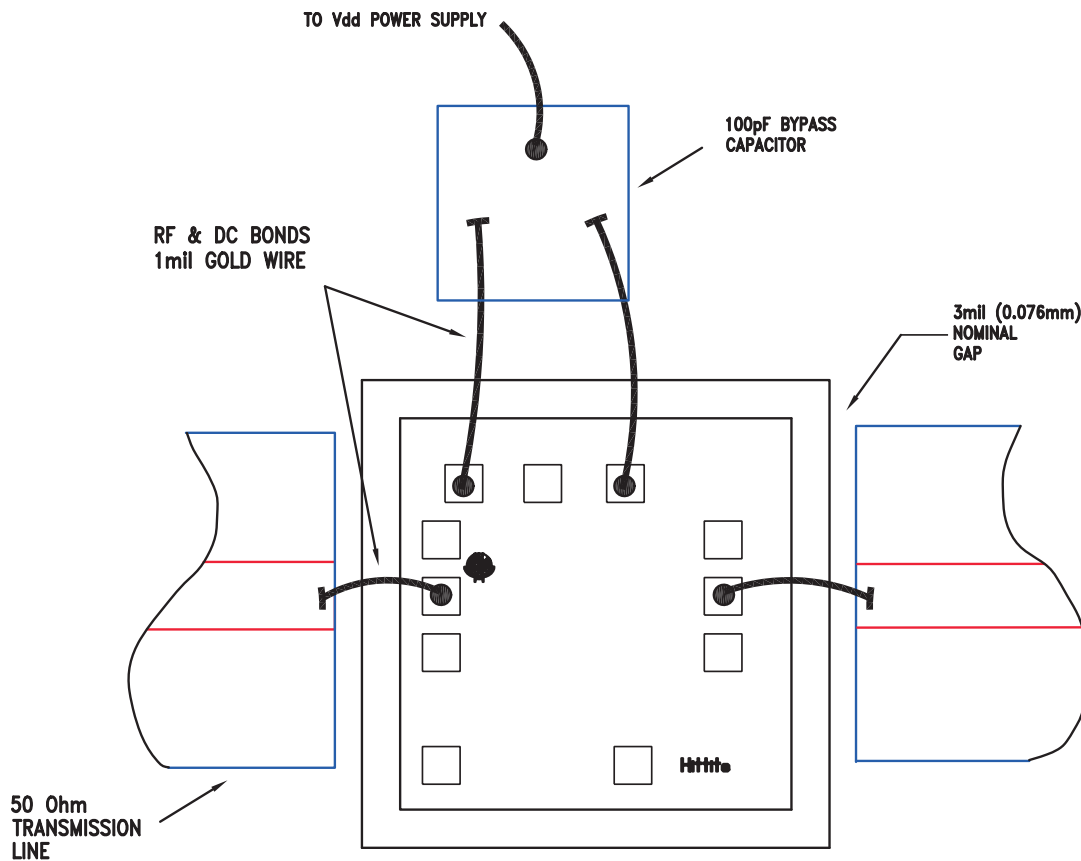

**GaAs PHEMT MMIC MEDIUM
POWER AMPLIFIER, 6 - 18 GHz**

(b) Assembly with Optional Gate Bias Voltage Operation

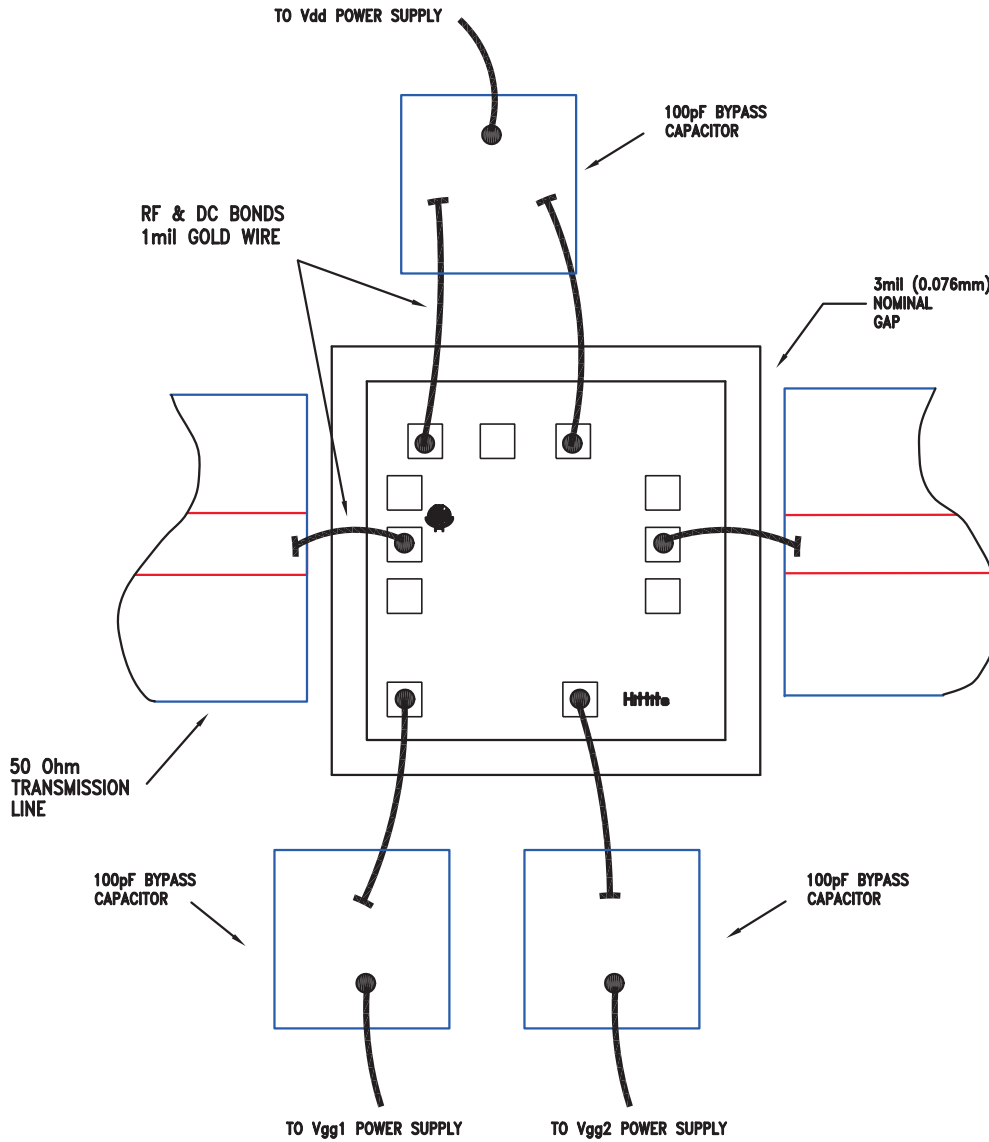

**GaAs PHEMT MMIC MEDIUM
POWER AMPLIFIER, 6 - 18 GHz**

Mounting & Bonding Techniques for Millimeterwave GaAs MMICs

The die should be attached directly to the ground plane eutectically or with conductive epoxy (see HMC general Handling, Mounting, Bonding Note).

50 Ohm Microstrip transmission lines on 0.127mm (5 mil) thick alumina thin film substrates are recommended for bringing RF to and from the chip (Figure 1). If 0.254mm (10 mil) thick alumina thin film substrates must be used, the die should be raised 0.150mm (6 mils) so that the surface of the die is coplanar with the surface of the substrate. One way to accomplish this is to attach the 0.102mm (4 mil) thick die to a 0.150mm (6 mil) thick molybdenum heat spreader (moly-tab) which is then attached to the ground plane (Figure 2).

Microstrip substrates should be brought as close to the die as possible in order to minimize bond wire length. Typical die-to-substrate spacing is 0.076mm to 0.152 mm (3 to 6 mils).

Handling Precautions

Follow these precautions to avoid permanent damage.

Storage: All bare die are placed in either Waffle or Gel based ESD protective containers, and then sealed in an ESD protective bag for shipment. Once the sealed ESD protective bag has been opened, all die should be stored in a dry nitrogen environment.

Cleanliness: Handle the chips in a clean environment. DO NOT attempt to clean the chip using liquid cleaning systems.

Static Sensitivity: Follow ESD precautions to protect against ESD strikes.

Transients: Suppress instrument and bias supply transients while bias is applied. Use shielded signal and bias cables to minimize inductive pick-up.

General Handling: Handle the chip along the edges with a vacuum collet or with a sharp pair of bent tweezers. The surface of the chip may have fragile air bridges and should not be touched with vacuum collet, tweezers, or fingers.

Mounting

The chip is back-metallized and can be die mounted with AuSn eutectic preforms or with electrically conductive epoxy. The mounting surface should be clean and flat.

Eutectic Die Attach: A 80/20 gold tin preform is recommended with a work surface temperature of 255 °C and a tool temperature of 265 °C. When hot 90/10 nitrogen/hydrogen gas is applied, tool tip temperature should be 290 °C. DO NOT expose the chip to a temperature greater than 320 °C for more than 20 seconds. No more than 3 seconds of scrubbing should be required for attachment.

Epoxy Die Attach: Apply a minimum amount of epoxy to the mounting surface so that a thin epoxy fillet is observed around the perimeter of the chip once it is placed into position. Cure epoxy per the manufacturer's schedule.

Wire Bonding

Ball or wedge bond with 0.025mm (1 mil) diameter pure gold wire. Thermosonic wirebonding with a nominal stage temperature of 150 °C and a ball bonding force of 40 to 50 grams or wedge bonding force of 18 to 22 grams is recommended. Use the minimum level of ultrasonic energy to achieve reliable wirebonds. Wirebonds should be started on the chip and terminated on the package or substrate. All bonds should be as short as possible <0.31mm (12 mils).

