



## GaAs MMIC 20W FAILSAFE SWITCH 0.2 - 2.2 GHz

### Typical Applications

The HMC546MS8G(E) is ideal for:

- LNA Protection, WiMAX, WiBro
- Cellular/PCS/3G Infrastructure
- Private Mobile Radio and Public Safety Handsets
- Automotive Telematics

### Features

- High Input P0.1dB: +40 dBm Tx
- Low Insertion Loss: 0.4 dB
- High IIP3: +65 dBm
- Positive Control: 0/+3V to 0/+8V
- Failsafe Operation: Tx "on" When Unpowered

### Functional Diagram

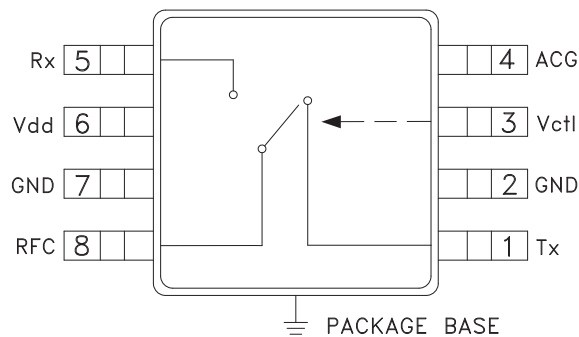

### General Description

The HMC546MS8G(E) is a low-cost SPDT switch in 8-lead MSOP8G surface mount package for use in transmit-receive applications which require very low distortion at high signal power levels, up to 10 watts. The device can control signals from 200 - 2200 MHz\* and is especially suited for cellular booster, PMR and automotive telematic applications. The design provides exceptional P0.1dB of +40 dBm and +65 dBm IIP3 on the Transmit (Tx) port. The failsafe topology allows the switch to provide a low loss path from RFC to Tx, when no DC power is available.

### Electrical Specifications, $T_A = +25^\circ C$ , $V_{dd} = 3V$ , $V_{ctl} = 0/+3 V_{dc}$ , 50 Ohm System\*

| Parameter   | Min.                      | Typ. | Max. | Min.      | Typ. | Max. | Min.        | Typ. | Max. | Min.        | Typ. | Max. | Units |
|---|---------------------------|------|------|-----------|------|------|-------------|------|------|-------------|------|------|-------|
| Frequency Range   | 216 - 222                 |      |      | 869 - 960 |      |      | 2010 - 2025 |      |      | 2110 - 2170 |      |      | MHz   |
| Insertion Loss  | Tx - RFC                  | 0.4  | 0.7  |           | 0.4  | 0.7  |             | 0.3  | 0.6  |             | 0.4  | 0.7  | dB    |
|   | RFC - Rx                  | 0.4  | 0.7  |           | 0.5  | 0.8  |             | 0.5  | 0.8  |             | 1.1  | 1.5  | dB    |
| Isolation   | Tx - RFC                  | 25   | 30   |           | 20   | 24   |             | 17   | 20   |             | 8    | 12   | dB    |
|   | RFC - Rx                  | 33   | 40   |           | 23   | 30   |             | 25   | 30   |             | 25   | 30   | dB    |
| Return Loss   | Tx - RFC                  |      | 20   |           |      | 25   |             |      | 23   |             |      | 16   | dB    |
|   | RFC - Rx                  |      | 20   |           |      | 25   |             |      | 20   |             |      | 13   | dB    |
| Input Power for 0.1 dB Compression  | Tx - RFC                  | 37   | 39   |           | 37   | 39   |             | 38   | >40  |             | 38   | >40  | dBm   |
|   | RFC - Rx                  | 19   | 21   |           | 19   | 21   |             | 17.5 | 19.5 |             | 17.5 | 19.5 | dBm   |
| Input Power for 1 dB Compression  | Tx - RFC                  | 43   |      |           | 43   |      |             | 43   |      |             | 43   |      | dBm   |
|   | RFC - Rx                  | 22   |      |           | 22   |      |             | 22   |      |             | 22   |      | dBm   |
| Input Third Order Intercept<br>(Two-tone input power = +19 dBm each tone) | Tx - RFC                  |      | 60   |           |      | 66   |             |      | 67   |             |      | 67   | dBm   |
|   | Vctl = 0/+3V RFC - Rx     |      | 31   |           |      | 32   |             |      | 31   |             |      | 31   | dBm   |
|   | Tx - RFC                  |      | 60   |           |      | 66   |             |      | 67   |             |      | 67   | dBm   |
|   | Vctl = 0/+5V RFC - Rx     |      | 57   |           |      | 48   |             |      | 37   |             |      | 43   | dBm   |
| Switching Characteristics   | tRISE, tFALL (10%/90% RF) |      | 21   |           |      | 21   |             |      | 21   |             |      | 21   | ns    |
|   | tON, (50% CTL to 90% RF)  |      | 102  |           |      | 102  |             |      | 102  |             |      | 102  | ns    |
|   | tOFF (50% CTL to 10% RF)  |      | 36   |           |      | 36   |             |      | 36   |             |      | 36   | ns    |

\* Specifications and data reflect HMC546MS8G(E) measured using the respective application circuits for each designated frequency band found herein

For price, delivery, and to place orders, please contact Hittite Microwave Corporation:  
20 Alpha Road, Chelmsford, MA 01824 Phone: 978-250-3343 Fax: 978-250-3373

Order On-Line at [www.hittite.com](http://www.hittite.com)  
**www.BDTC.com/Hittite/**



**GaAs MMIC 20W FAILSAFE SWITCH  
0.2 - 2.2 GHz**

**Insertion Loss vs. Temperature, Tx with 220 MHz Tuning**

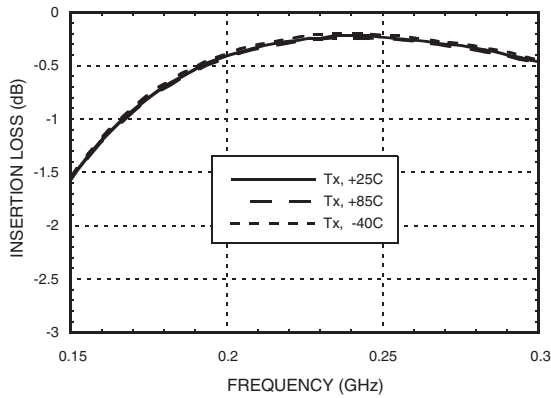

**Insertion Loss vs. Temperature, Rx with 220 MHz Tuning**

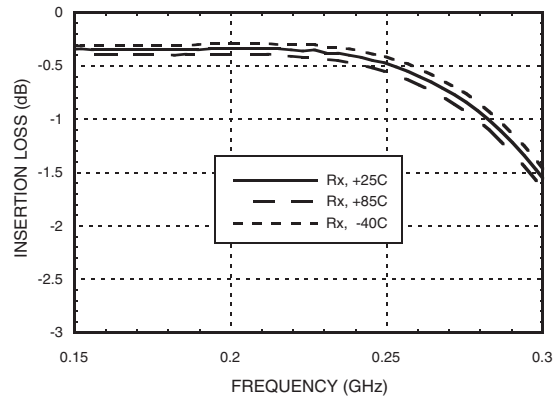

**Isolation with 220 MHz Tuning**

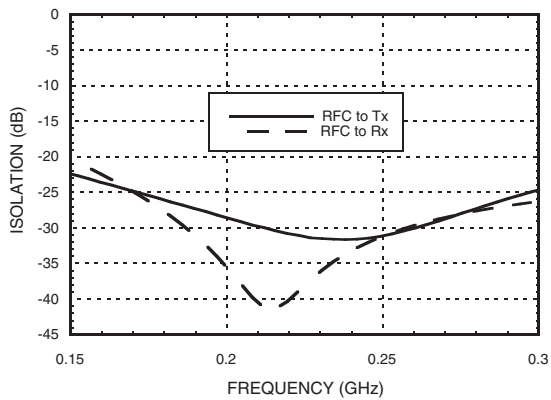

**Return Loss with 220 MHz Tuning**

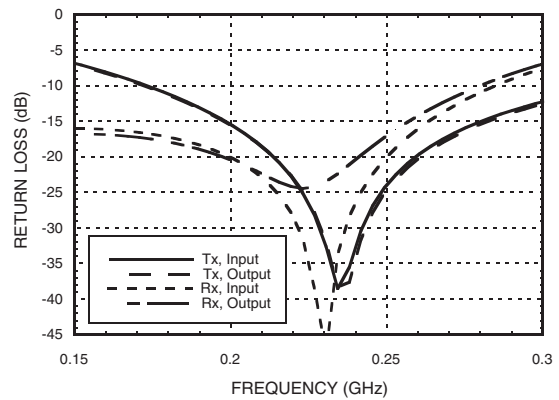

**Input IP3 vs. Voltage with 220 MHz Tuning**

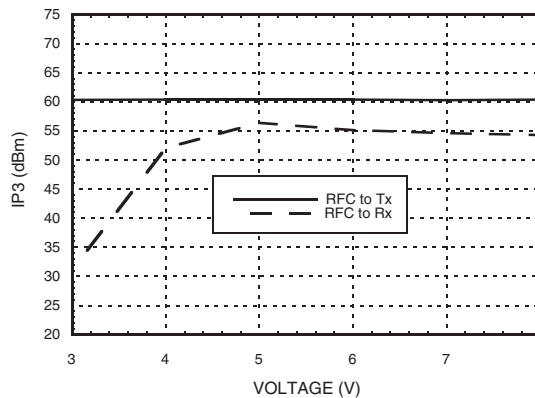

11

SWITCHES - SPDT T/R - SMT



**GaAs MMIC 20W FAILSAFE SWITCH  
0.2 - 2.2 GHz**

**Insertion Loss vs. Temperature, Tx with 457 MHz Tuning**

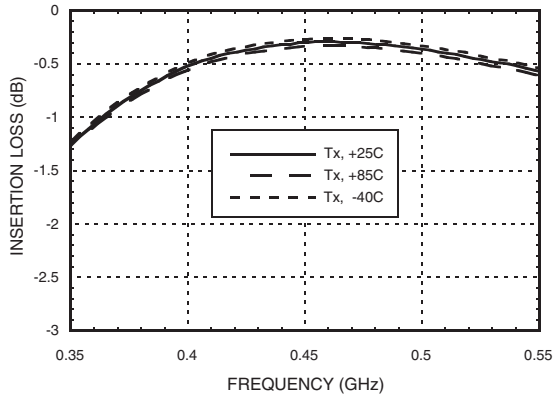

**Insertion Loss vs. Temperature, Rx with 457 MHz Tuning**

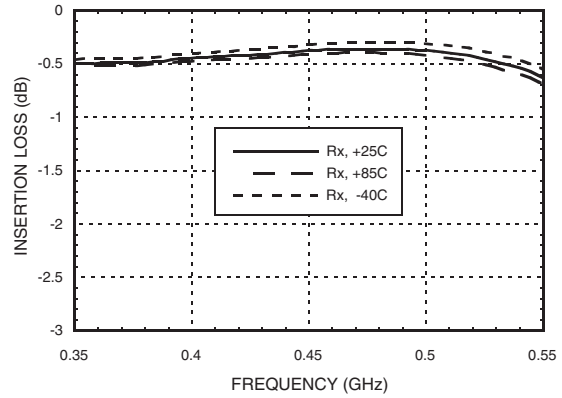

**Isolation with 457 MHz Tuning**

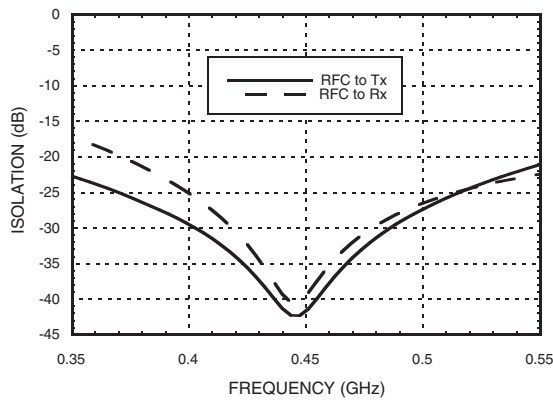

**Return Loss with 457 MHz Tuning**

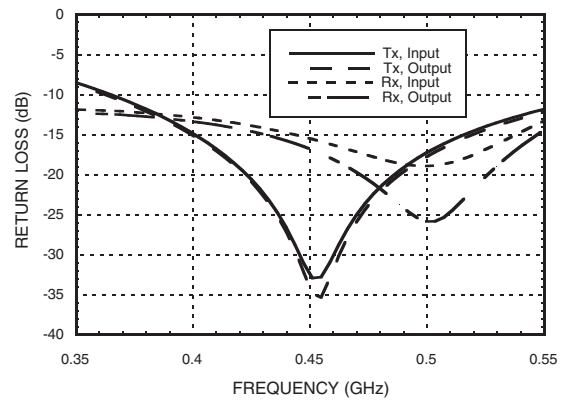

**Input IP3 vs. Voltage with 457 MHz Tuning**

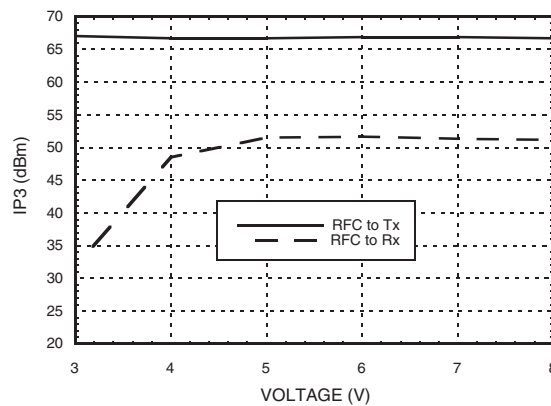

11

SWITCHES - SPDT T/R - SMT



**GaAs MMIC 20W FAILSAFE SWITCH  
0.2 - 2.2 GHz**

**Insertion Loss vs. Temperature, Tx with 785 MHz Tuning**

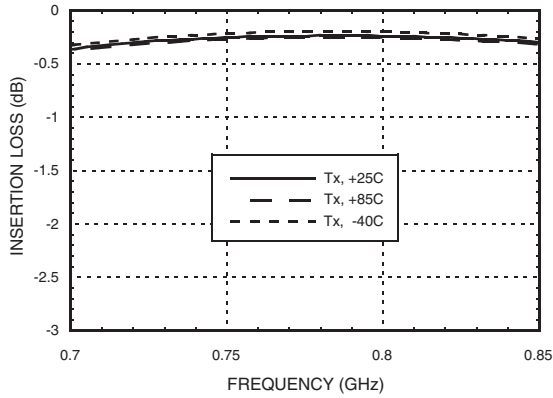

**Insertion Loss vs. Temperature, Rx with 785 MHz Tuning**

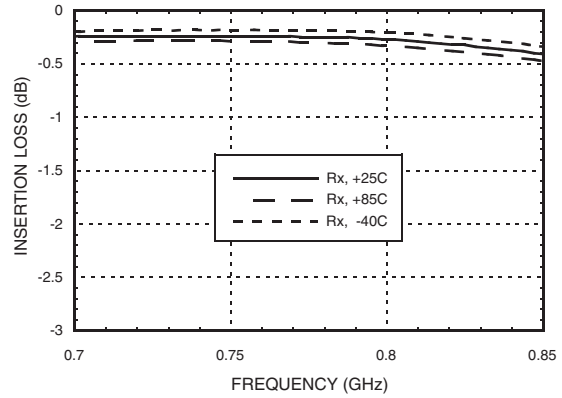

**Isolation with 785 MHz Tuning**

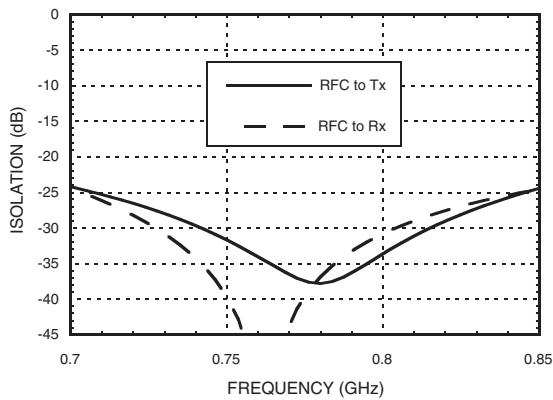

**Return Loss with 785 MHz Tuning**

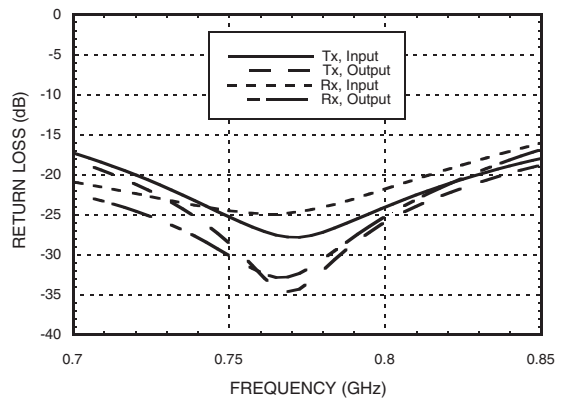

**Input IP3 vs. Voltage with 785 MHz Tuning**

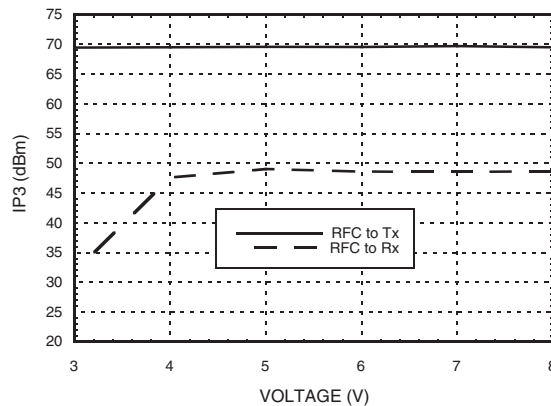



**GaAs MMIC 20W FAILSAFE SWITCH  
0.2 - 2.2 GHz**

**Insertion Loss vs. Temperature, Tx with 915 MHz Tuning**

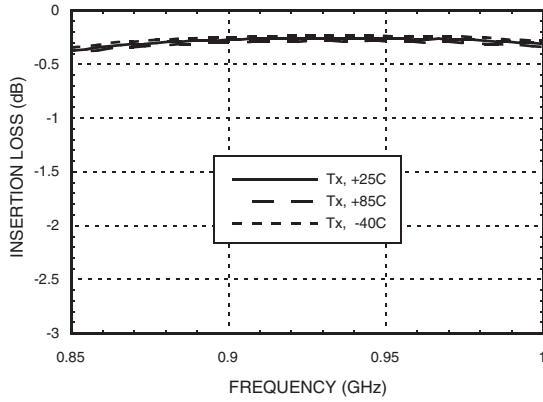

**Insertion Loss vs. Temperature, Rx with 915 MHz Tuning**

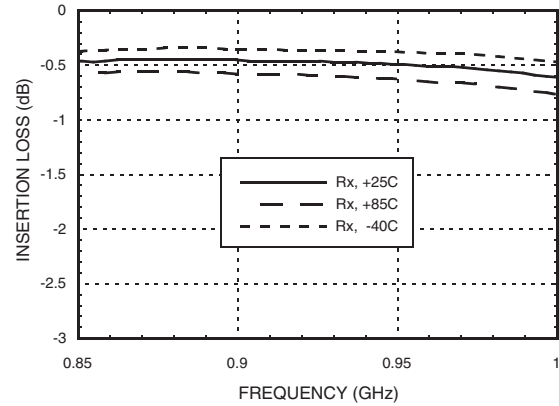

**Isolation with 915 MHz Tuning**

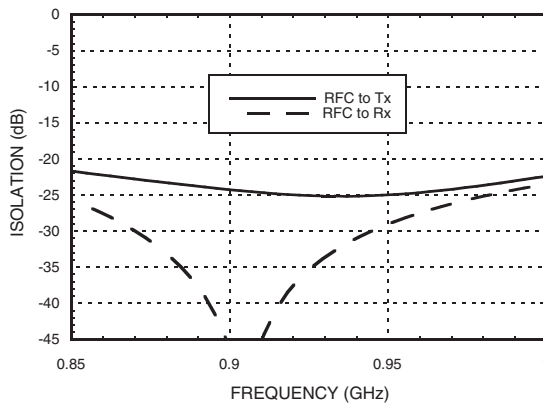

**Return Loss with 915 MHz Tuning**

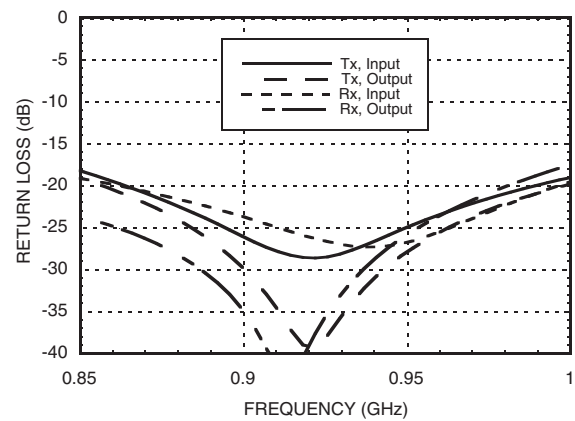

**Input IP3 vs. Voltage with 915 MHz Tuning**

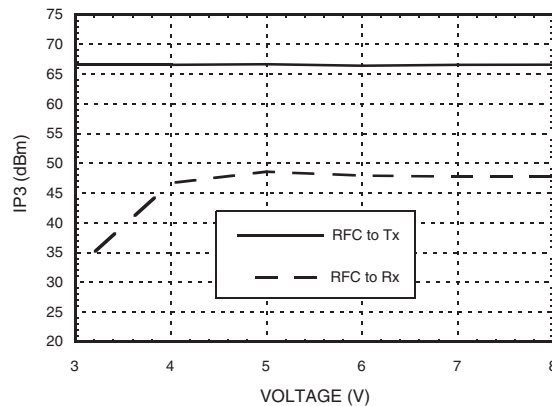



## GaAs MMIC 20W FAILSAFE SWITCH 0.2 - 2.2 GHz

**Insertion Loss vs. Temperature, Tx with 1843 MHz Tuning**

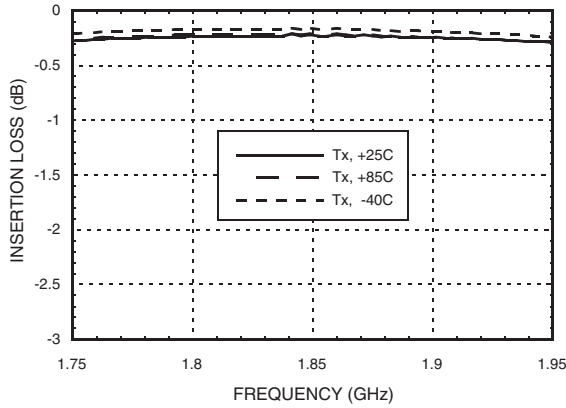

**Insertion Loss vs. Temperature, Rx with 1843 MHz Tuning**

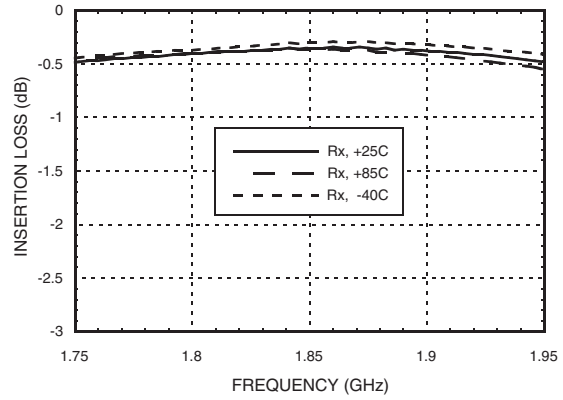

**Isolation with 1843 MHz Tuning**

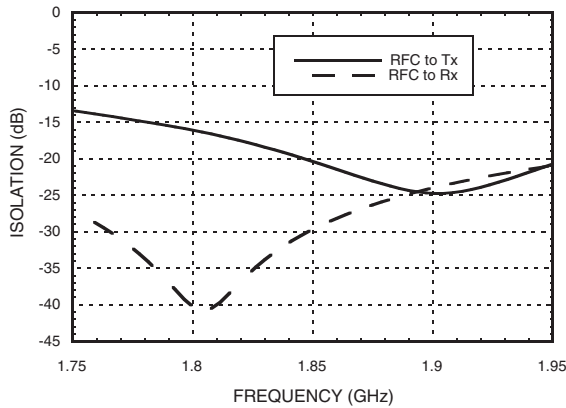

**Return Loss with 1843 MHz Tuning**

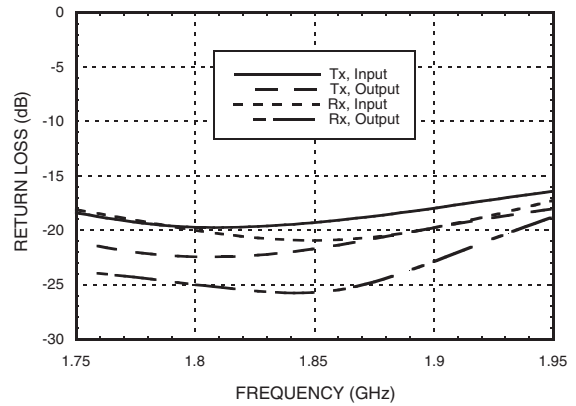

**Input IP3 vs. Voltage with 1843 MHz Tuning**





**GaAs MMIC 20W FAILSAFE SWITCH  
0.2 - 2.2 GHz**

**Insertion Loss vs. Temperature, Tx with 1960 MHz Tuning**

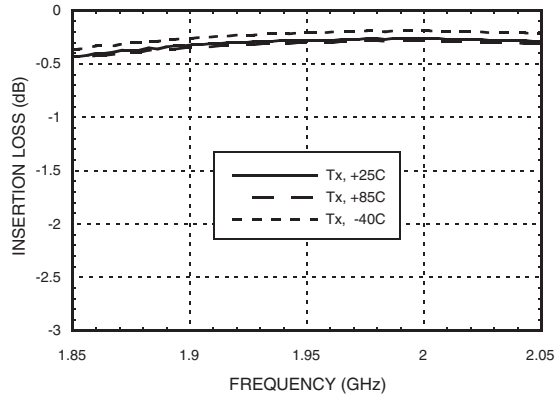

**Insertion Loss vs. Temperature, Rx with 1960 MHz Tuning**



**Isolation with 1960 MHz Tuning**

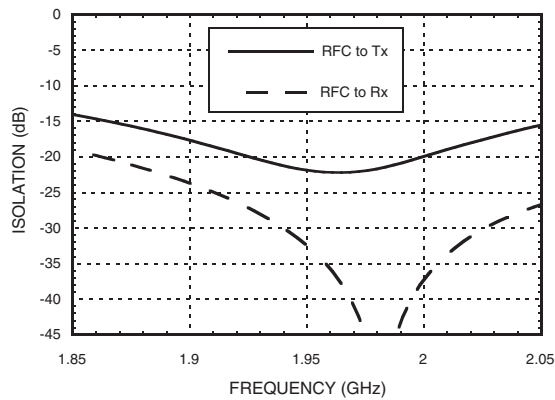

**Return Loss with 1960 MHz Tuning**

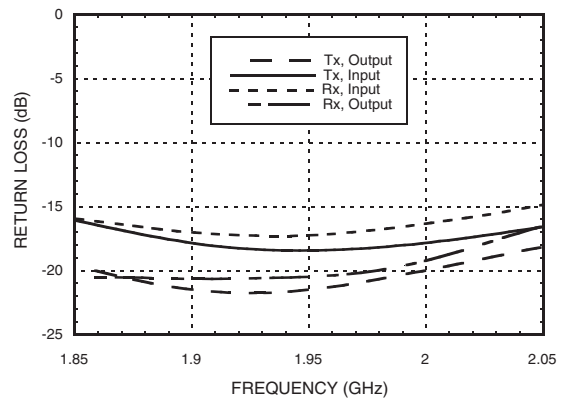

**Input IP3 vs. Voltage with 1960 MHz Tuning**

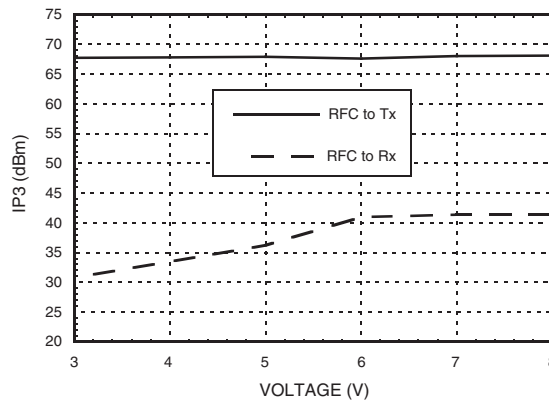



## GaAs MMIC 20W FAILSAFE SWITCH 0.2 - 2.2 GHz

**Insertion Loss vs. Temperature, Tx with 2015 MHz Tuning**

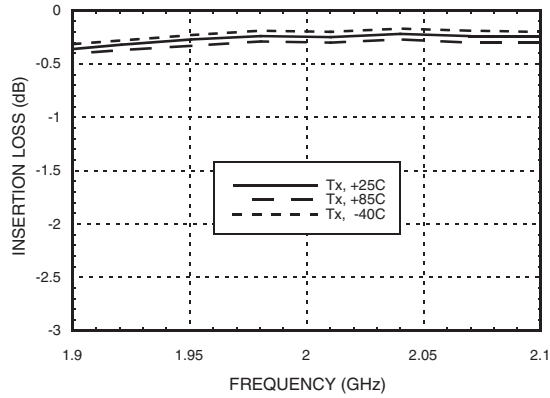

**Insertion Loss vs. Temperature, Rx with 2015 MHz Tuning**

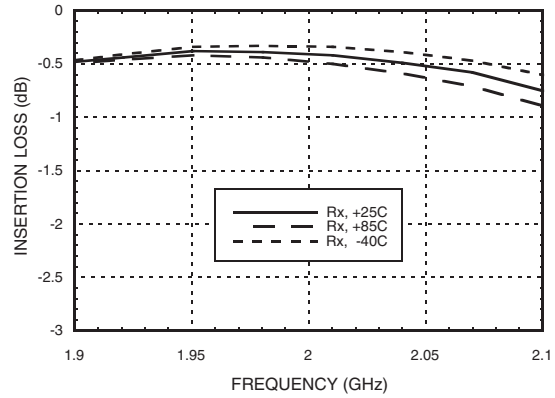

**Isolation with 2015 MHz Tuning**

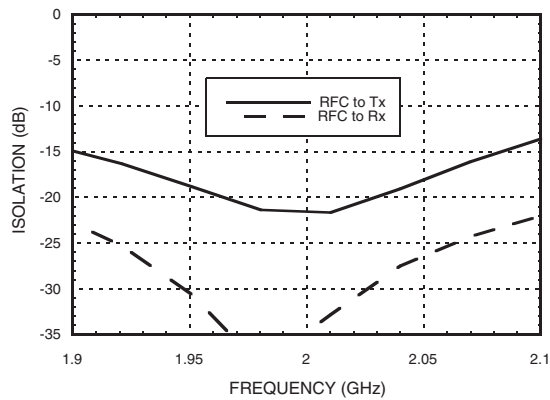

**Return Loss with 2015 MHz Tuning**

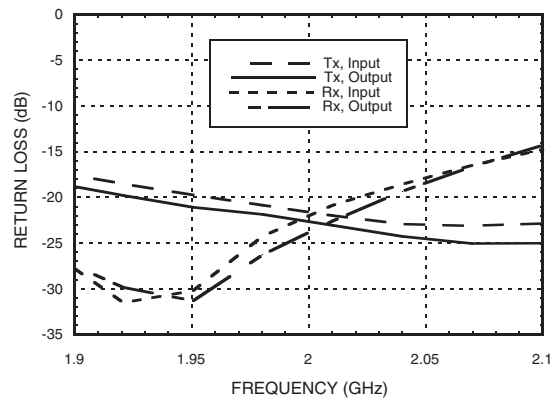

**Input IP3 vs. Voltage with 2015 MHz Tuning**

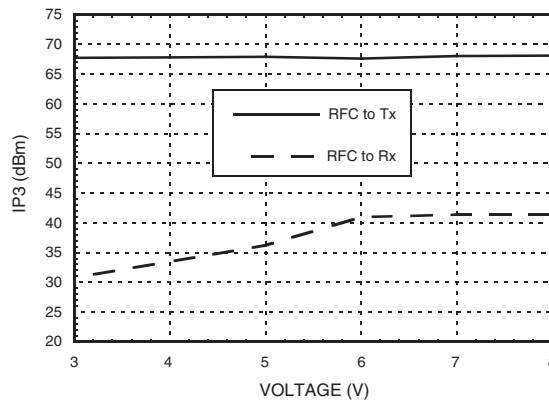





**GaAs MMIC 20W FAILSAFE SWITCH  
0.2 - 2.2 GHz**

**Insertion Loss vs. Temperature, Tx with 2140 MHz Tuning**



**Insertion Loss vs. Temperature, Rx with 2140 MHz Tuning**

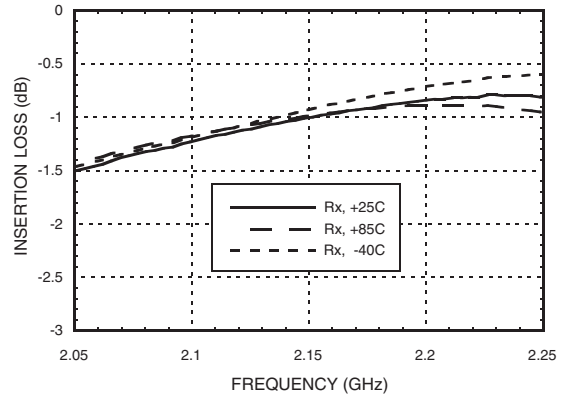

**Isolation with 2140 MHz Tuning**



**Return Loss with 2140 MHz Tuning**

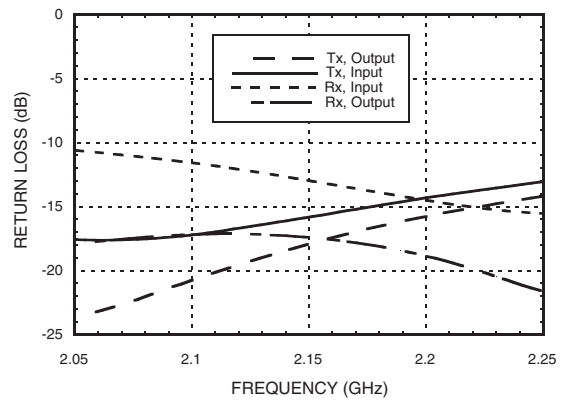

**Input IP3 vs. Voltage with 2140 MHz Tuning**

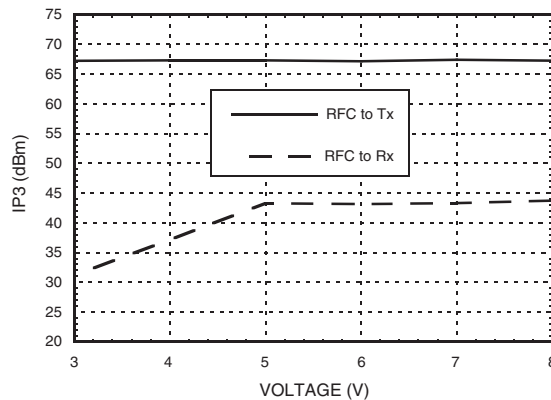



## GaAs MMIC 20W FAILSAFE SWITCH 0.2 - 2.2 GHz

### Absolute Maximum Ratings

|                              |         | 3V               | 5V      |
|------------------------------|---------|------------------|---------|
| Max. CW Input Power [1][2]   | Tx Port | 40 dBm           | 40 dBm  |
|                              | Rx Port | 24 dBm           | 29 dBm  |
| Max Channel Temp.            |         | 150 °C           | 150 °C  |
| Thermal Resistance           | Tx Port | 54 °C/W          | 54 °C/W |
|                              | Rx Port | 68 °C/W          | 86 °C/W |
| Continuous Dissipated Power  | Tx Port | 1.12 W           | 1.12 W  |
|                              | Rx Port | 73 mW            | 232 mW  |
| Supply Voltage (Vdd)         |         | +10V             |         |
| Control Voltage Range (Vctl) |         | -0.2 to Vdd + 1V |         |
| Storage Temperature          |         | -65 to +150 °C   |         |
| Operating Temperature        |         | -40 to +85 °C    |         |
| ESD Sensitivity (HBM)        |         | Class 1A         |         |

[1] Do not "hot switch" power levels greater than +24 dBm.

[2] Max input power can be higher for duty cycle <100%

### Truth Table

| Control Input<br>Vctl (V) | Signal Path State |           |
|---------------------------|-------------------|-----------|
|                           | RFC To Tx         | RFC to Rx |
| 0.0                       | OFF               | ON        |
| Vdd                       | ON                | OFF       |

Vdd = +3V to +8V  
Control Input Voltage Tolerances are ± 0.2 Vdc.

DC blocking capacitors are required at ports RFC, Tx and Rx.



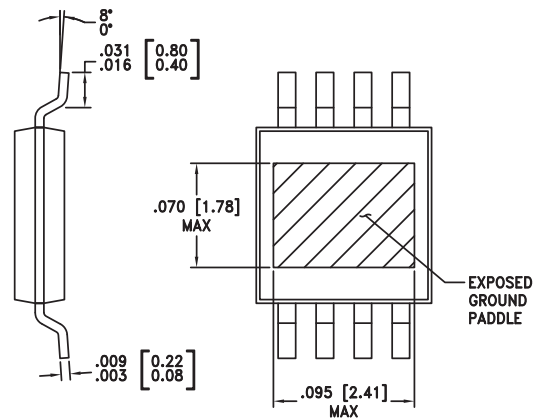
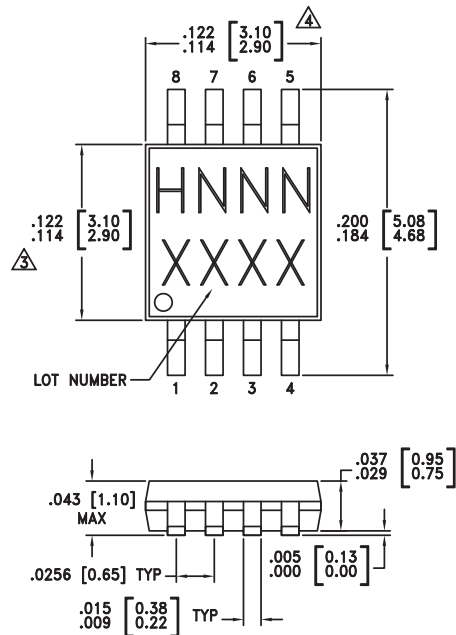

**ELECTROSTATIC SENSITIVE DEVICE  
OBSERVE HANDLING PRECAUTIONS**

### Outline Drawing



#### NOTES:

- LEADFRAME MATERIAL: COPPER ALLOY
- DIMENSIONS ARE IN INCHES [MILLIMETERS]
-  DIMENSION DOES NOT INCLUDE MOLDFLASH OF 0.15mm PER SIDE.
-  DIMENSION DOES NOT INCLUDE MOLDFLASH OF 0.25mm PER SIDE.
- ALL GROUND LEADS AND GROUND PADDLE MUST BE SOLDERED TO PCB RF GROUND.

### Package Information

| Part Number | Package Body Material                               | Lead Finish   | MSL Rating | Package Marking [3] |
|-------------|---|---------------|------------|---------------------|
| HMC546MS8G  | Low Stress Injection Molding Plastic                | Sn/Pb Solder  | MSL1 [1]   | H546<br>XXXX        |
| HMC546MS8GE | RoHS-compliant Low Stress Injection Molding Plastic | 100% matte Sn | MSL1 [2]   | <u>H546</u><br>XXXX |

[1] Max peak reflow temperature of 235 °C

[2] Max peak reflow temperature of 260 °C

[3] 4-Digit lot number XXXX

For price, delivery, and to place orders, please contact Hittite Microwave Corporation:  
20 Alpha Road, Chelmsford, MA 01824 Phone: 978-250-3343 Fax: 978-250-3373

Order On-Line at [www.hittite.com](http://www.hittite.com)  
**www.BDTC.com/Hittite/**



## GaAs MMIC 20W FAILSAFE SWITCH 0.2 - 2.2 GHz

### Pin Descriptions

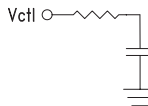
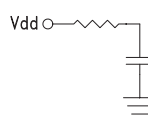
| Pin Number | Function | Description   | Interface Schematic   |
|------------|----------|---|---|
| 1          | Tx       | This pin is DC coupled and matched to 50 Ohms.                            |   |
| 2, 7       | GND      | This pin must be connected to PCB RF ground.                              |  |
| 3          | Vctl     | See Truth Table.  |  |
| 4          | ACG      | External capacitor to ground is required. See application circuit herein. |   |
| 5          | Rx       | This pin is DC coupled and matched to 50 Ohms.                            |   |
| 6          | Vdd      | Supply Voltage  |  |
| 8          | RFC      | This pin is DC coupled and matched to 50 Ohms.                            |   |

### Application Circuit

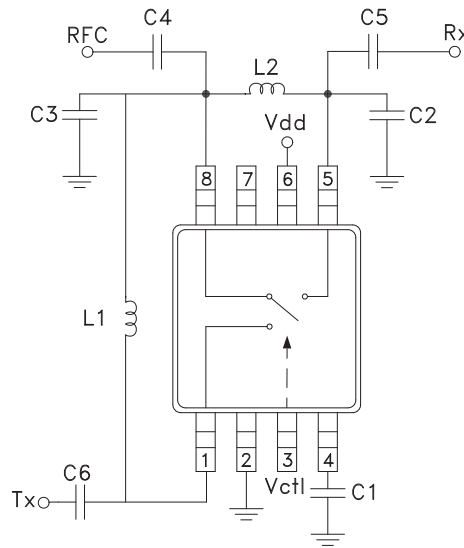

### Components for Selected Frequencies

| Tuned Frequency       | 220 MHz    | 457 MHz    | 785 MHz   | 915 MHz    | 1843 MHz   | 1960 MHz   | 2015 MHz   | 2140 MHz   |
|-----------------------|------------|------------|-----------|------------|------------|------------|------------|------------|
| Evaluation PCB Number | 110123     | 110124     | 110125    | 110126     | 110127     | 110128     | 115708     | 110129     |
| C1                    | 150 pF     | 33 pF      | 11 pF     | 8 pF       | 1.6 pF     | 1.5 pF     | 1.3 pF     | 1.2 pF     |
| C2                    | 12 pF      | 6.2 pF     | 2 pF      | 1.8 pF     | N/A        | N/A        | N/A        | N/A        |
| C3                    | 12 pF      | 7 pF       | 3 pF      | 2.7 pF     | 1 pF       | 1 pF       | 0.9 pF     | 1 pF       |
| C4-C6 [1]             | 1000pF     | 1000pF     | 1000pF    | 1000pF     | 1000pF     | 1000pF     | 1000pF     | 1000pF     |
| L1                    | 390 nH [2] | 100 nH [4] | 33 nH [4] | 23 nH [3]  | 3.3 nH [3] | 2.4 nH [3] | 2.2 nH [3] | 1 nH [3]   |
| L2                    | 36 nH [3]  | 15 nH [3]  | 10 nH [3] | 8.2 nH [3] | 3.9 nH [3] | 3.6 nH [3] | 3.6 nH [3] | 2.7 nH [4] |

[1] DC blocking capacitors

[2] Coilcraft 0603LS series inductor, 5% tolerance

[3] Coilcraft 0402CS series inductor, 5% tolerance

[4] Toko LL1005-FH series inductor, 5% tolerance

For price, delivery, and to place orders, please contact Hittite Microwave Corporation:  
20 Alpha Road, Chelmsford, MA 01824 Phone: 978-250-3343 Fax: 978-250-3373

Order On-Line at [www.hittite.com](http://www.hittite.com)  
**www.BDTIC.com/Hittite/**

### Evaluation PCB

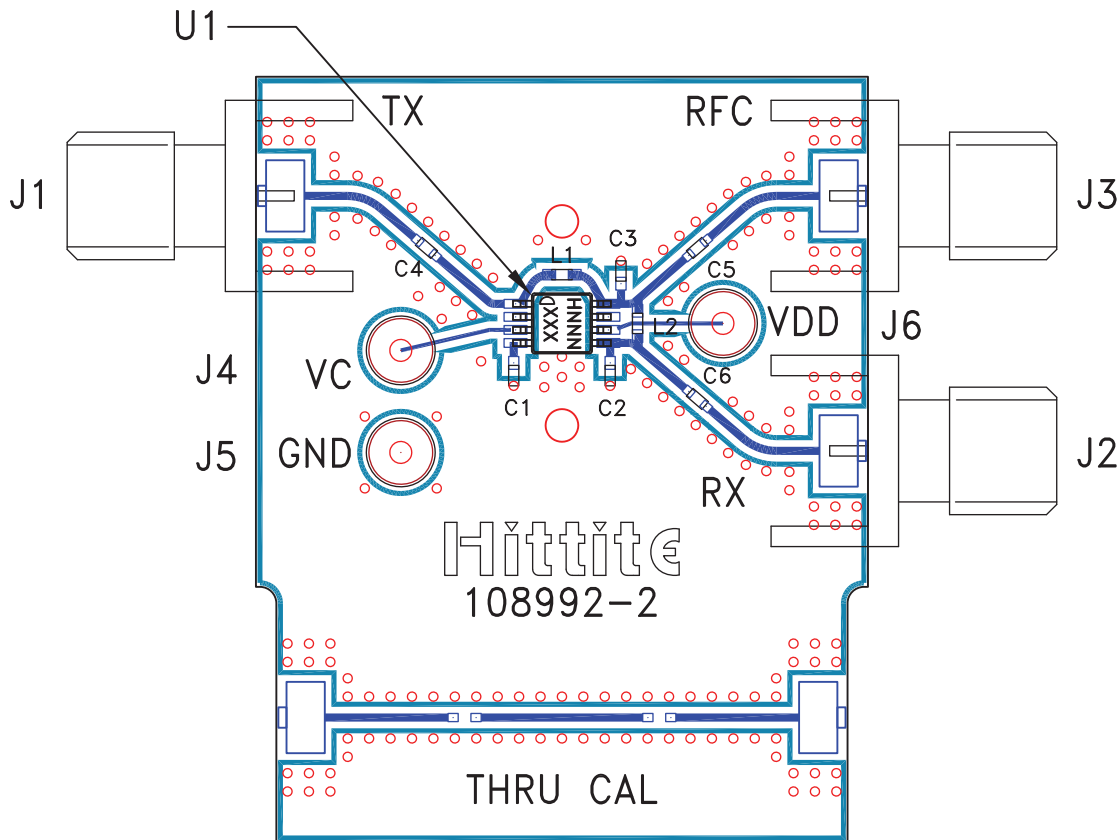

### List of Materials for Evaluation PCB [3]

| Item        | Description                         |
|-------------|-------------------------------------|
| J1 - J3     | PCB Mount SMA RF Connector          |
| J4 - J6     | DC Pin                              |
| C1 - C6 [1] | Capacitor, 0402 Pkg.                |
| L1 - L2 [1] | Inductor, 0402 Pkg.                 |
| U1          | HMC546MS8G / HMC546MS8GE T/R Switch |
| PCB [2]     | 108992 Evaluation PCB               |

[1] Please refer to "Components for Selected Frequencies" table for values.

[2] Circuit Board Material: Rogers 4350

[3] When requesting an evaluation board, please reference the appropriate evaluation PCB number listed in the table "Components for Selected Frequencies."

The circuit board used in the application should be generated with proper RF circuit design techniques. Signal lines at the RF port should have 50 Ohm impedance and the package ground leads and exposed paddle should be connected directly to the ground plane similar to that shown above. The evaluation circuit board shown above is available from Hittite Microwave Corporation upon request.