



## GaAs PHEMT MMIC LOW NOISE AMPLIFIER w/ BYPASS MODE, 4.8 - 6.0 GHz

### Typical Applications

The HMC604LP3 / HMC604LP3E is ideal for:

- WiMAX/C-band Radio
- Fixed Wireless
- Tower Mounted Amplifiers
- Public Safety Infrastructure
- Telematics & DSRC

### Functional Diagram

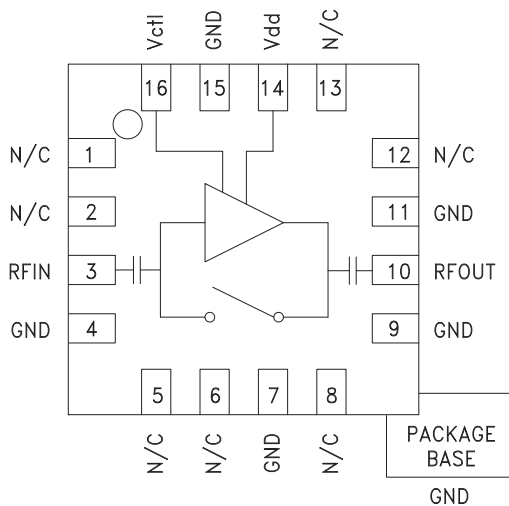

### Features

- Noise Figure: 1.5 dB
- Output IP3: +26 dBm
- Gain: 15 dB
- Integrated Low Loss LNA Bypass Path
- Single Supply: +3V or +5V
- 50 Ohm Matched Output/Input
- 16 Lead 3x3mm QFN Package: 9 mm<sup>2</sup>

### General Description

The HMC604LP3(E) is a versatile, high dynamic range GaAs MMIC Low Noise Amplifier that integrates a low loss LNA bypass mode on the IC. The amplifier is ideal for WiMAX & C-band Radio receivers operating between 4.8 and 6.0 GHz and provides 1.5 dB noise figure, 15 dB of gain and +26 dBm IP3 from a single supply of +5V @ 42mA. Input and output return losses are 12 and 14 dB respectively with no external matching components required. A single control line (0/Vdd) is used to switch between LNA mode and a low loss bypass mode which reduces the current consumption to 10  $\mu$ A.

### Electrical Specifications, $T_A = +25^\circ C$

Parameter	Vdd = +3V						Vdd = +5V						Units
	LNA Mode			Bypass Mode			LNA Mode			Bypass Mode			
	Min.	Typ.	Max.	Min.	Typ.	Max.	Min.	Typ.	Max.	Min.	Typ.	Max.	
Frequency Range	4.8 - 6.0						4.8 - 6.0						GHz
Gain	10	12.5		-3	-2		13	15		-3	-2		dB
Gain Variation Over Temperature		0.026			0.002			0.026			0.002		dB / °C
Noise Figure		1.6	2.1		2			1.5	2		2		dB
Input Return Loss		14			20			12			20		dB
Output Return Loss		15			20			14			20		dB
Reverse Isolation		28			-			30			-		dB
Power for 1dB Compression (P1dB)*		10			24			14			24		dBm
Saturated Output Power (Psat)		10.5			25			14.5			25		dBm
Third Order Intercept (IP3)* (-20 dBm Input Power per tone, 1 MHz tone spacing)		21			23			26			23		dBm
Supply Current (Idd)		17	25		0.01			42	55		0.01		mA
Switching Speed	LNA Mode to Bypass Mode		7					6					ns
	Bypass Mode to LNA Mode					50					150		ns

\* P1dB and IP3 for LNA Mode are referenced to RFOUT while P1dB for Bypass Mode is referenced to RFIN.



## GaAs PHEMT MMIC LOW NOISE AMPLIFIER w/ BYPASS MODE, 4.8 - 6.0 GHz

7

AMPLIFIERS - LOW NOISE - SMT

**LNA Broadband Gain & Return Loss @ Vdd= 3V**

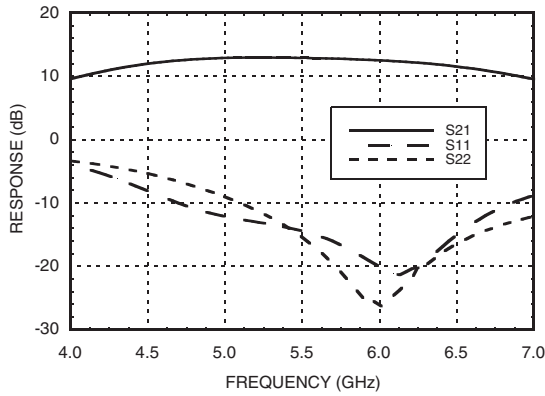

**LNA Broadband Gain & Return Loss @ Vdd= 5V**

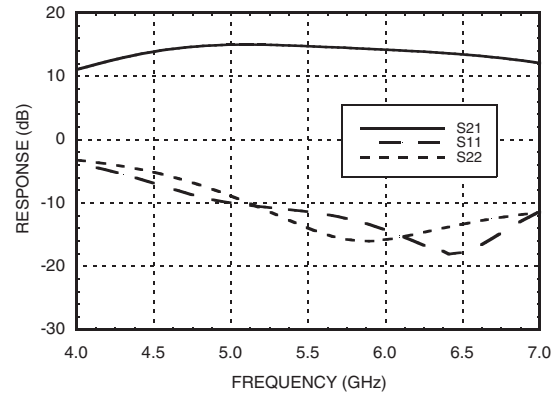

**LNA Gain vs. Temperature**

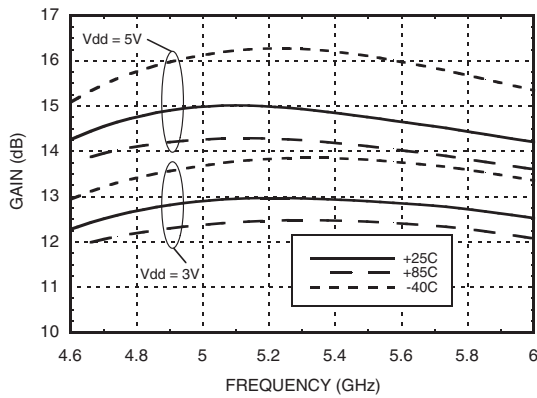

**LNA Noise Figure vs. Temperature**

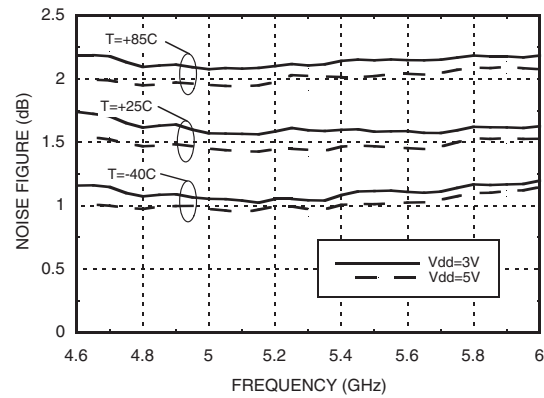

**LNA Gain vs. Vdd**

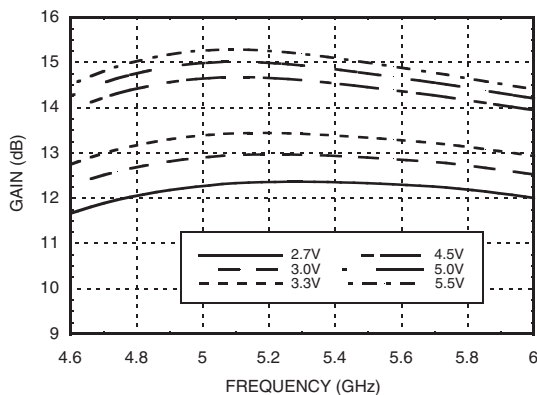

**LNA Noise Figure vs. Vdd**

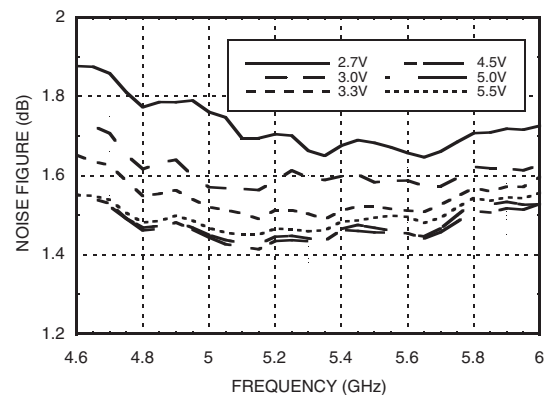



# HMC604LP3 / 604LP3E

## GaAs PHEMT MMIC LOW NOISE AMPLIFIER w/ BYPASS MODE, 4.8 - 6.0 GHz

**LNA Input Return Loss vs. Temperature @ Vdd= 3V**

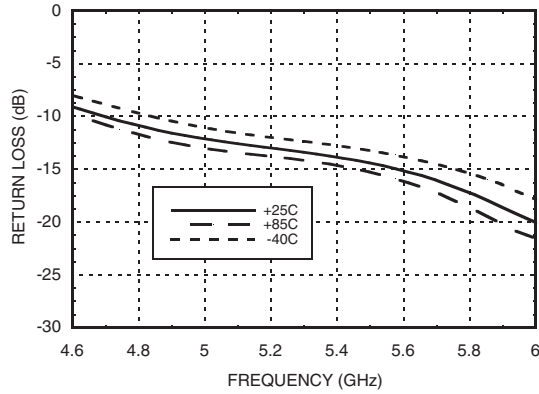

**LNA Input Return Loss vs. Temperature @ Vdd= 5V**

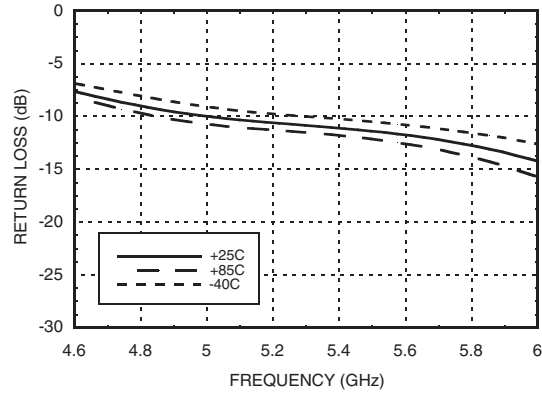

**LNA Output Return Loss vs. Temperature @ Vdd= 3V**

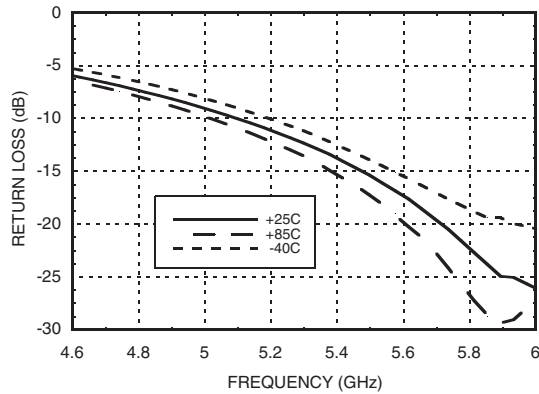

**LNA Output Return Loss vs. Temperature @ Vdd= 5V**

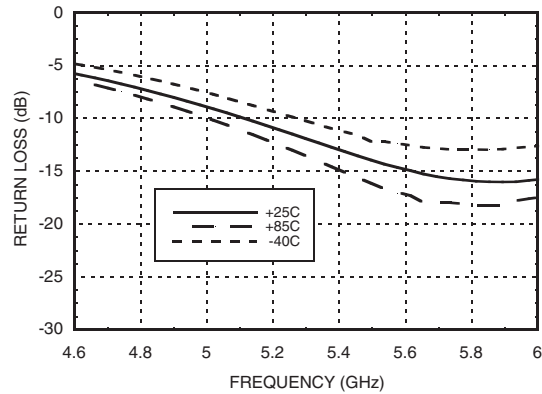

**LNA Output IP3 vs. Temperature**

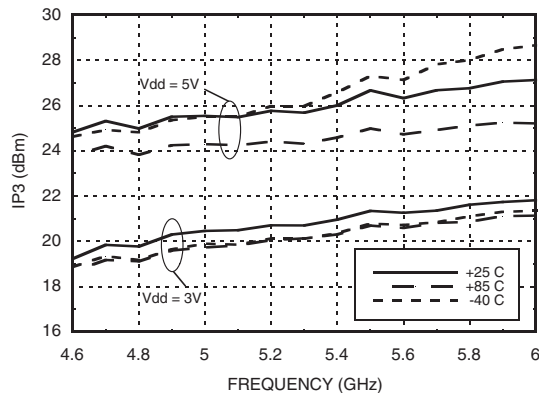

**LNA Output IP3 vs. Vdd**

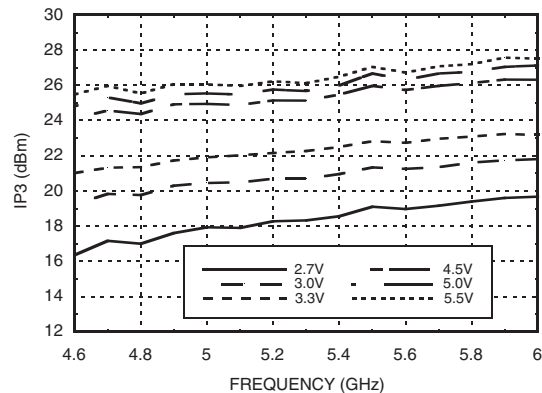

**LNA Psat vs. Temperature**

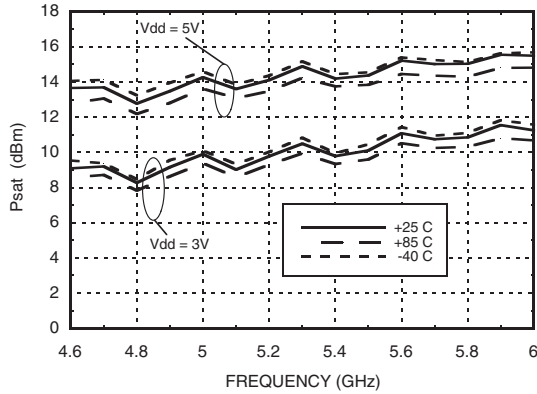

**LNA Psat vs. Vdd**

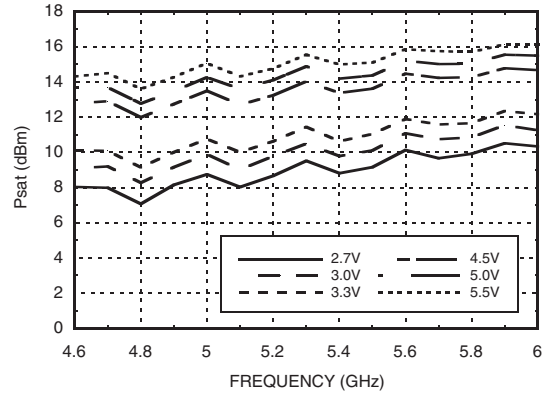

**LNA Output P1dB vs. Temperature**

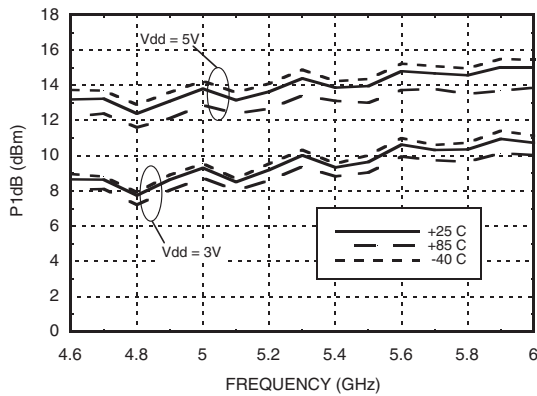

**LNA Output P1dB vs. Vdd**

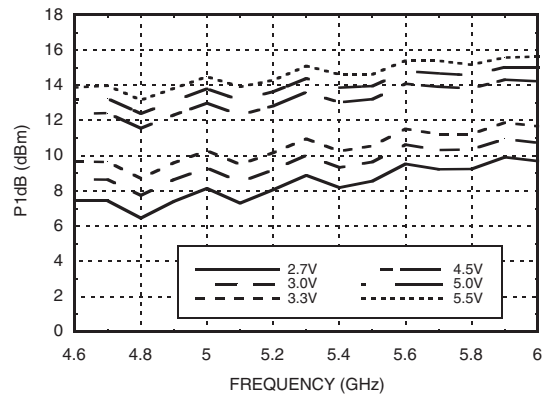

**LNA Reverse Isolation vs. Temperature**

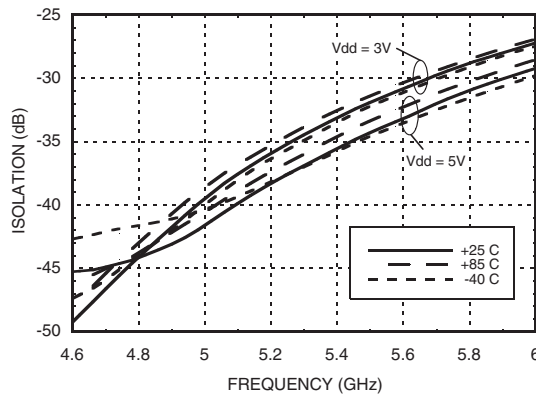

**Bypass Mode  
Broadband Gain & Return Loss [1]**

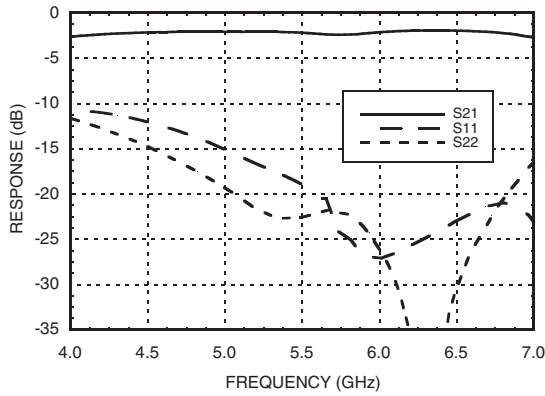

**Bypass Mode  
Broadband Gain & Return Loss [2]**

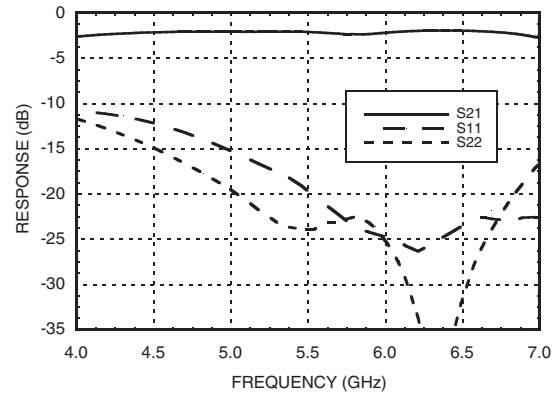

**Bypass Mode  
Insertion Loss vs. Temperature [1]**

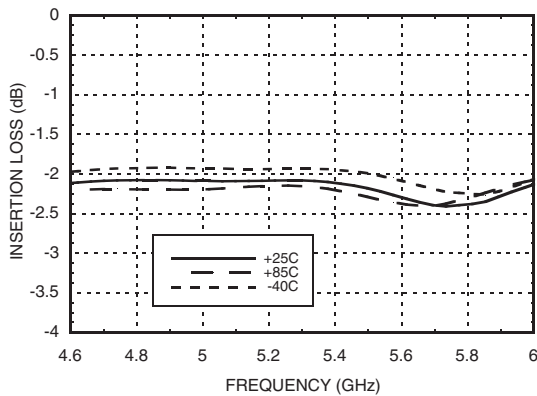

**Bypass Mode  
Insertion Loss vs. Temperature [2]**

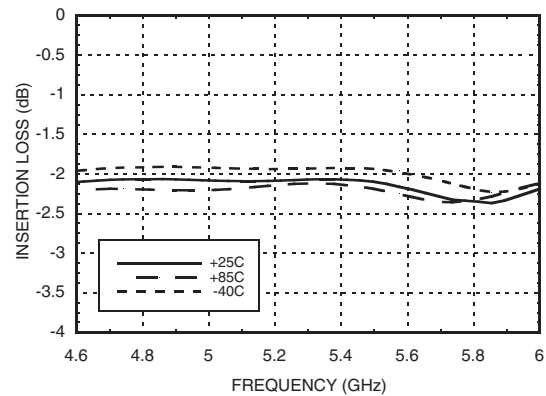

[1] Vdd = 3V [2] Vdd = 5V

**Bypass Mode  
Input Return Loss vs. Temperature [1]**

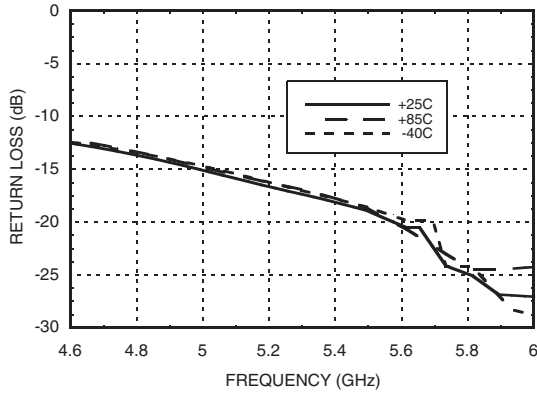

**Bypass Mode  
Output Return Loss vs. Temperature [1]**

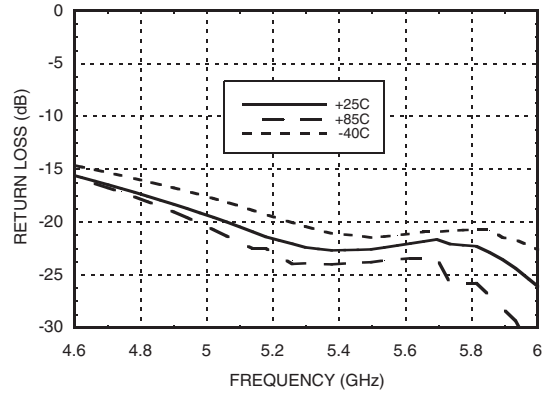

**Bypass Mode  
Output IP3 vs. Temperature [1]**

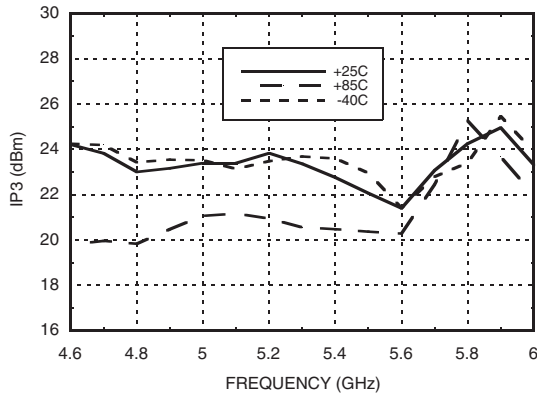

**Bypass Mode  
Output P1dB vs. Temperature [1]**

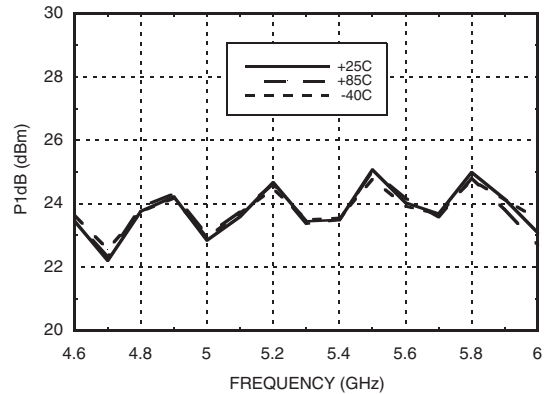

**Bypass Mode  
Psat vs. Temperature [1]**

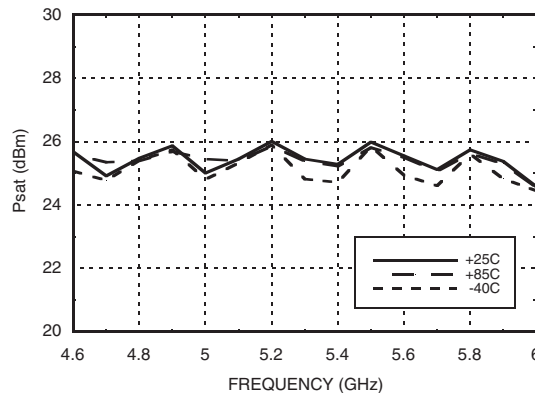

[1] Vdd = 3V or Vdd = 5V



### Absolute Maximum Ratings

Drain Bias Voltage (Vdd)	+8 Vdc
RF Input Power (RFIN)	LNA Mode +15 dBm
(Vdd = +5.0 Vdc)	Bypass Mode +30 dBm
Channel Temperature	150 °C
Continuous Pdiss (T = 85 °C) (derate 13 mW/°C above 85 °C)	850 mW
Thermal Resistance (channel to ground paddle)	76.9 °C/W
Storage Temperature	-65 to +150° C
Operating Temperature	-40 to +85° C

### Typical Supply Current vs. Vdd

Vdd (Vdc)	Idd (mA)
+2.7	13
+3.0	17
+3.3	21
+4.5	37
+5.0	42
+5.5	46



**ELECTROSTATIC SENSITIVE DEVICE  
OBSERVE HANDLING PRECAUTIONS**

### Truth Table

LNA Mode	Vctl= Vdd
Bypass Mode	Vctl= 0V

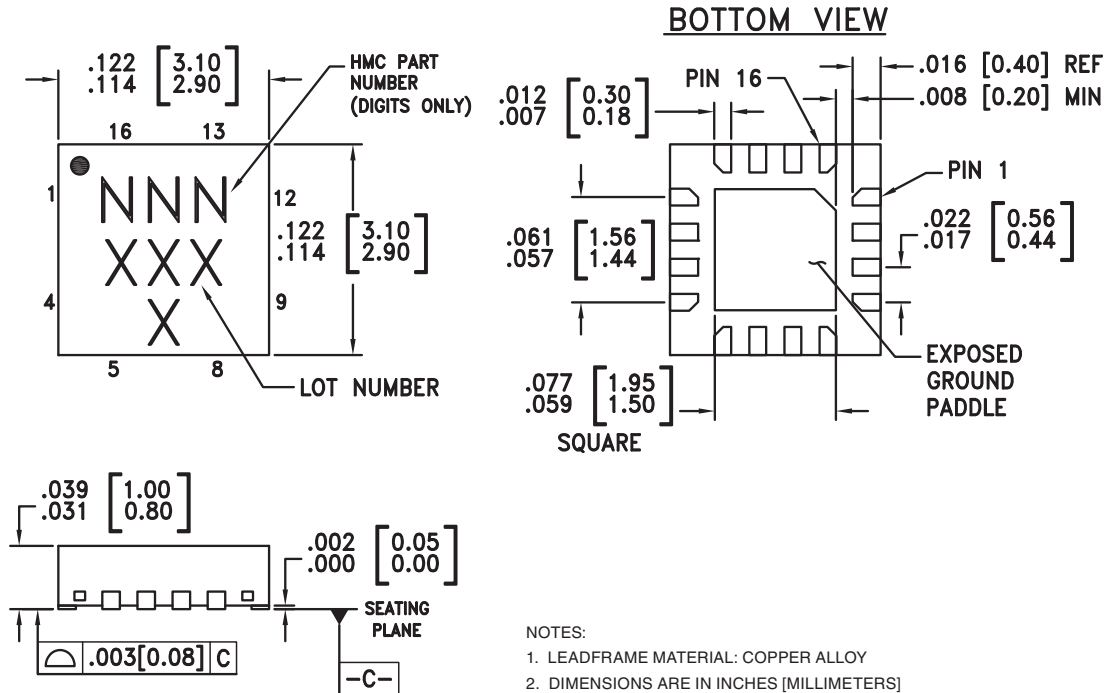
**Outline Drawing**

**NOTES:**

- LEADFRAME MATERIAL: COPPER ALLOY
- DIMENSIONS ARE IN INCHES [MILLIMETERS]
- LEAD SPACING TOLERANCE IS NON-CUMULATIVE
- PAD BURR LENGTH SHALL BE 0.15mm MAXIMUM.  
PAD BURR HEIGHT SHALL BE 0.05mm MAXIMUM.
- PACKAGE WARP SHALL NOT EXCEED 0.05mm.
- ALL GROUND LEADS AND GROUND PADDLE MUST BE SOLDERED TO PCB RF GROUND.
- REFER TO HITTITE APPLICATION NOTE FOR SUGGESTED LAND PATTERN.

**Package Information**

Part Number	Package Body Material	Lead Finish	MSL Rating	Package Marking <sup>[3]</sup>
HMC604LP3	Low Stress Injection Molded Plastic	Sn/Pb Solder	MSL1 <sup>[1]</sup>	604 XXXX
HMC604LP3E	RoHS-compliant Low Stress Injection Molded Plastic	100% matte Sn	MSL1 <sup>[2]</sup>	604 XXXX

[1] Max peak reflow temperature of 235 °C

[2] Max peak reflow temperature of 260 °C

[3] 4-Digit lot number XXXX







## GaAs PHEMT MMIC LOW NOISE AMPLIFIER w/ BYPASS MODE, 4.8 - 6.0 GHz

7

AMPLIFIERS - LOW NOISE - SMT

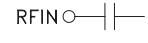
### Pin Descriptions

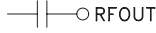
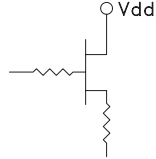
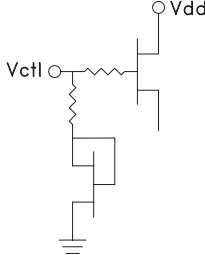
Pin Number	Function	Description	Interface Schematic
1, 2, 5, 6, 8, 12	N/C	No connection necessary. These pins may be connected to RF/DC ground.	
3	RFIN	This pin is AC coupled and matched to 50 Ohms.	
4, 7, 9, 11, 15	GND	These pins must be connected to RF/DC ground.	
10	RFOUT	This pin is AC coupled and matched to 50 Ohms.	
14	Vdd	Power supply voltage. Bypass capacitors are required. See application circuit.	
16	Vctl	LNA/Bypass Mode Control Voltage. See truth table.	

### Application Circuit

Components	Value
C1, C2	100pF
C3	10KpF

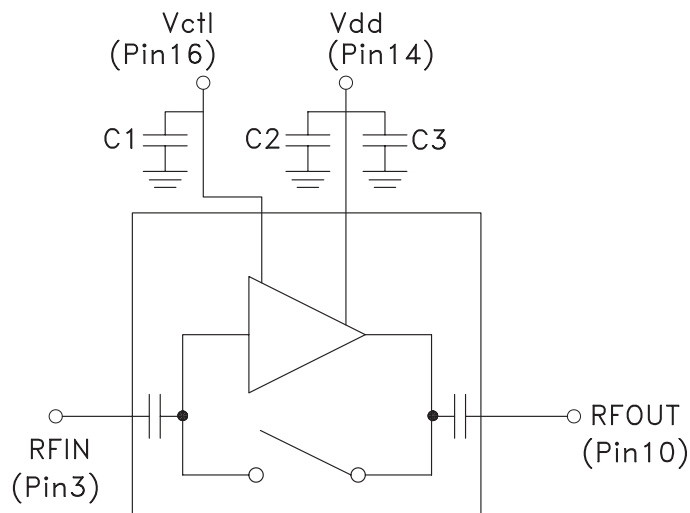

### Evaluation PCB

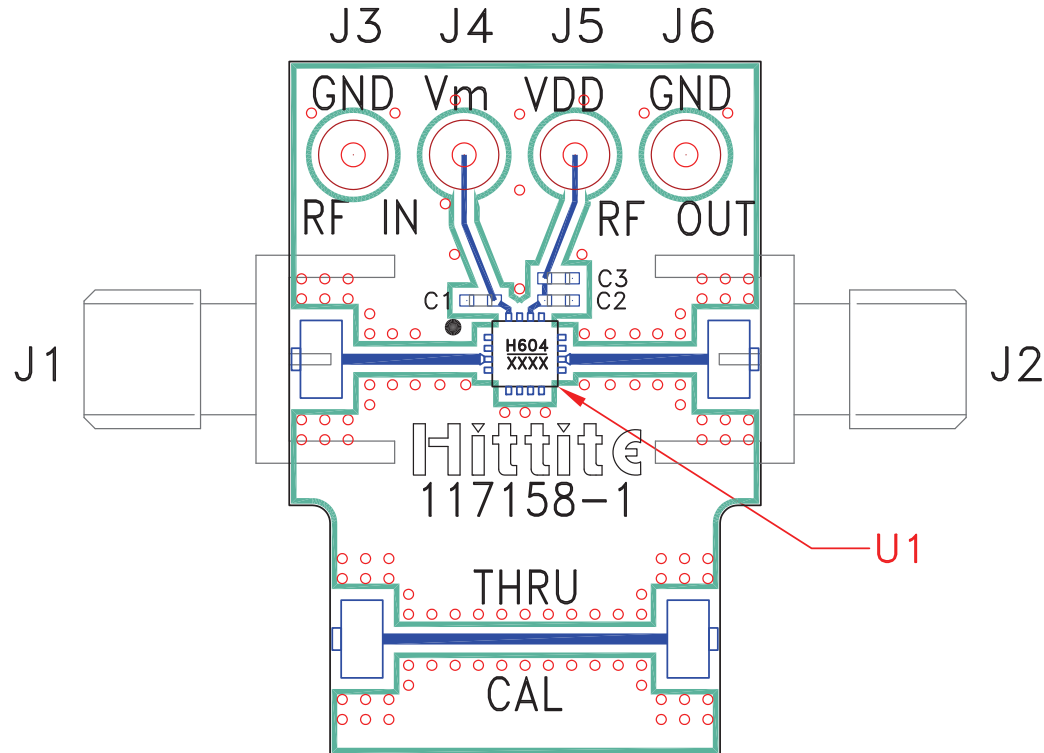

### List of Materials for Evaluation PCB 117160 [1]

Item	Description
J1 - J2	PCB Mount SMA RF Connector
J3 - J6	DC Pin
C1, C2	100 pF Capacitor, 0402 Pkg.
C3	10 KpF Capacitor, 0402 Pkg.
U1	HMC604LP3 / HMC604LP3E Amplifier
PCB [2]	117158 Evaluation Board

[1] Reference this number when ordering complete evaluation PCB

[2] Circuit Board Material: Rogers 4350

The circuit board used in the application should use RF circuit design techniques. Signal lines should have 50 Ohm impedance while the package ground leads and exposed paddle should be connected directly to the ground plane similar to that shown. A sufficient number of via holes should be used to connect the top and bottom ground planes. The evaluation circuit board shown is available from Hittite upon request.