

Typical Applications

The HMC711LC5 is ideal for:

- Point-to-Point & Point-to-Multi-Point Radio
- Military Radar, EW & ELINT
- Satellite Communications

Features

- Conversion Gain: 15 dB
- 2 LO to RF Isolation: 10 dB
- High Output IP3: 28 dBm
- High Output P1dB: 17 dBm
- 32 Lead Ceramic 5x5mm SMT Package: 25mm²

Functional Diagram

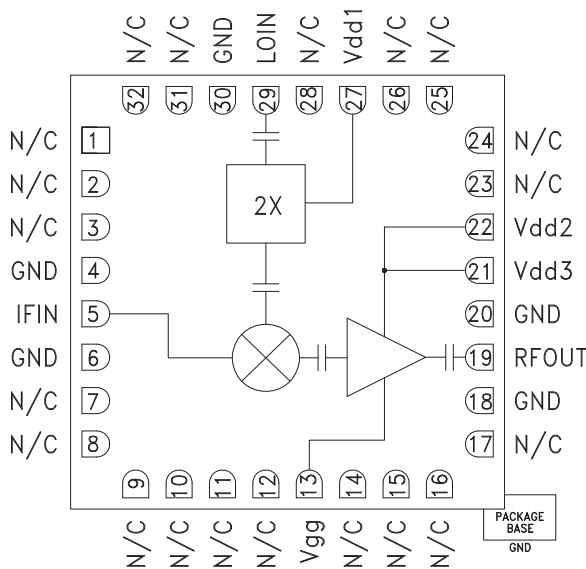

General Description

The HMC711LC5 is a GaAs MMIC sub-harmonic upconverter in a leadless RoHS compliant QFN SMT ceramic package. This compact upconverter provides a small signal conversion gain of 15 dB and wide IF bandwidth of DC - 3.5 GHz. The HMC711LC5 utilizes a mixer which is driven by an active x2 multiplier and followed by a high linearity amplifier. The HMC711LC5 is a much smaller alternative to hybrid style subharmonic upconverter assemblies and it eliminates the need for wire bonding by allowing the use of surface mount manufacturing techniques.

Electrical Specifications, IF = 1900 MHz, LO = +4 dBm, Vdd1, Vdd2, Vdd3 = +5V ^{[1][2]}

Parameter	Min.	Typ.	Max.	Units
Frequency Range, RF		17.7 - 23.6		GHz
Frequency Range, LO		9.5 - 13.6		GHz
Frequency Range, IF		DC - 3.5		GHz
Conversion Gain	10	15		dB
1 dB Compression (Output)		17		dBm
2 LO to RF Isolation		10		dB
2 LO to IF Isolation		25		dB
IP3 (Output)		28		dBm
Supply Current Idd1		80		mA
Supply Current (Idd2 + Idd3) ^[2]		240		mA

[1] Unless otherwise noted all measurements performed with high side LO, IF = 1900 MHz.

[2] Adjust Vgg between -2 to 0V to achieve Idd = 240mA typical.



**GaAs MMIC SUB-HARMONIC
UPCONVERTER, 17.7 - 23.6 GHz**

Data Taken as an Upconverter, IF = 1900 MHz

Conversion Gain, LSB vs. Temperature

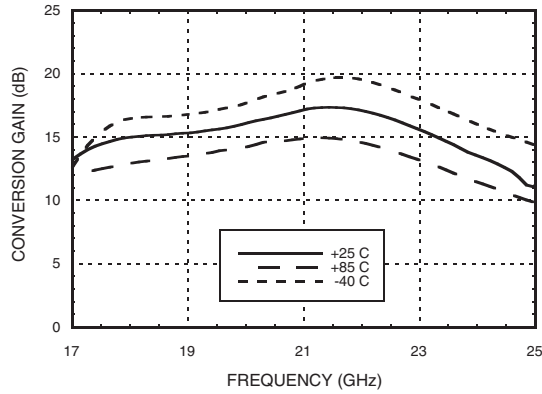

Conversion Gain, LSB vs. LO Drive

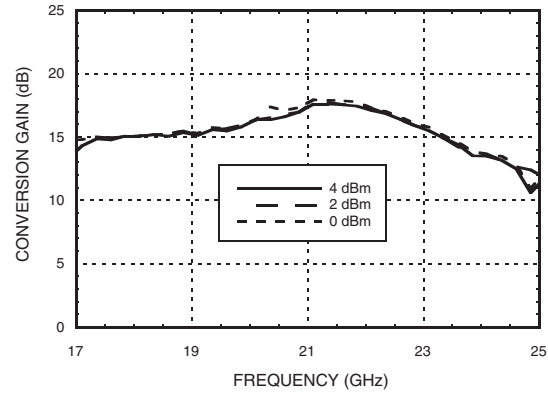

Conversion Gain, LSB vs. Vdd

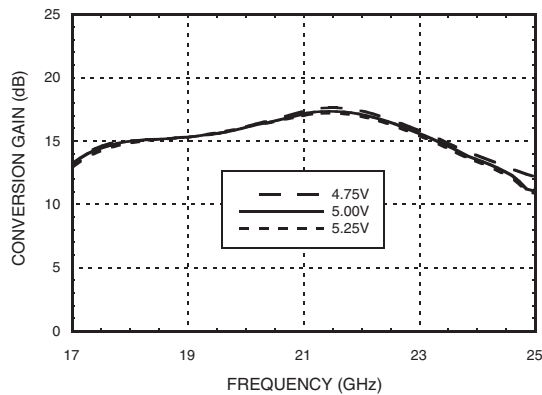

RF Return Loss vs. Temperature

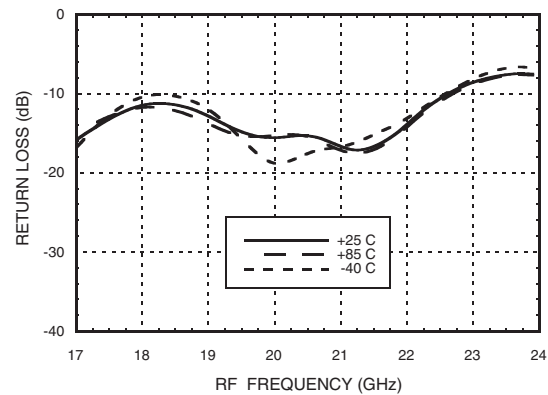

LO Return Loss vs. Temperature

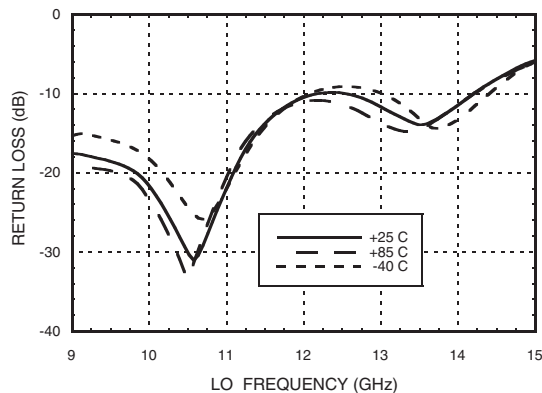

IF Return Loss

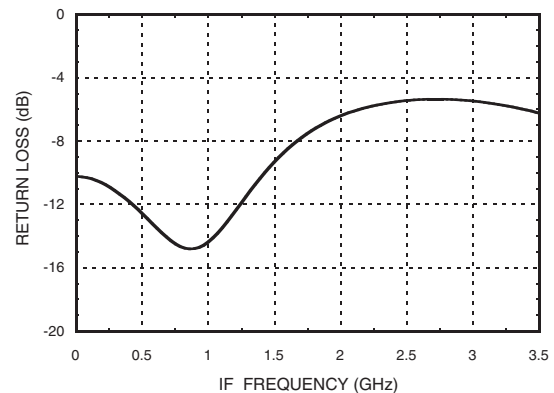



GaAs MMIC SUB-HARMONIC UPCONVERTER, 17.7 - 23.6 GHz

Data Taken as an Upconverter, IF = 1900 MHz

Input P1dB, LSB vs. Temperature

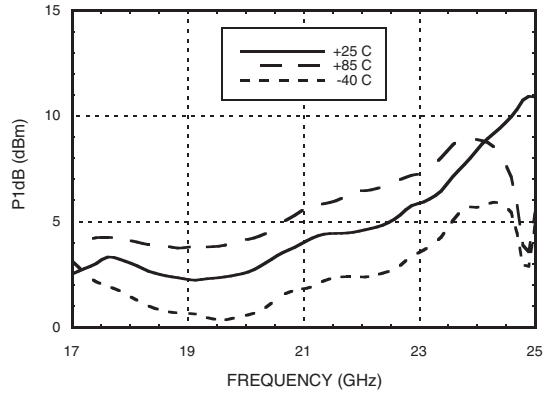

Output P1dB, LSB vs. Temperature

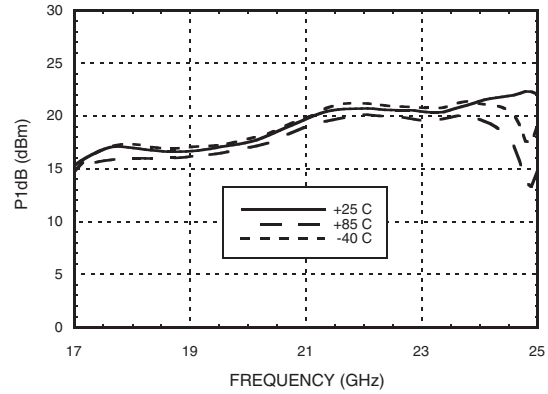

Input IP3, LSB vs. Temperature

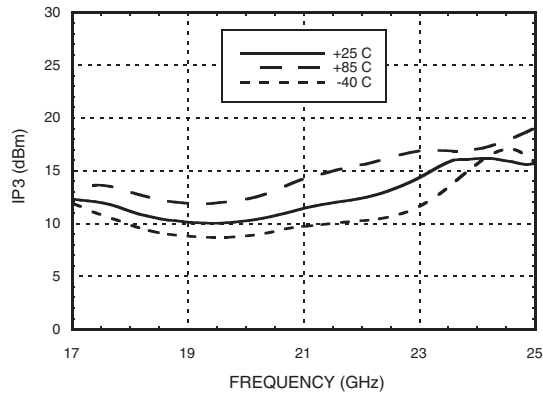

Output IP3, LSB vs. Temperature

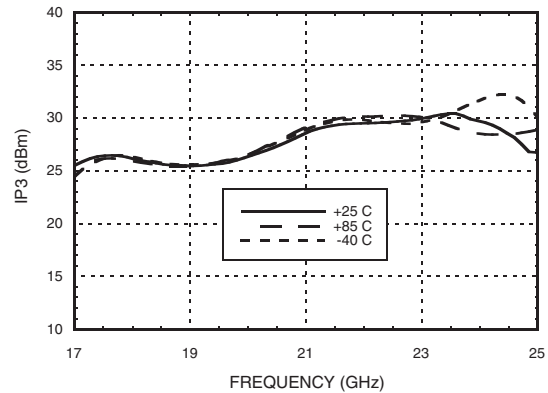

Input IP3, LSB vs. LO Drive

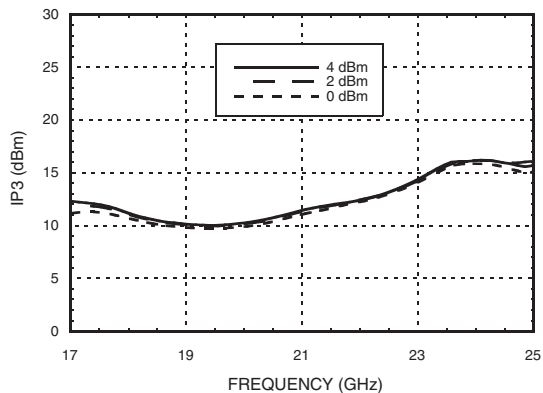

Output IP3, LSB vs. LO Drive

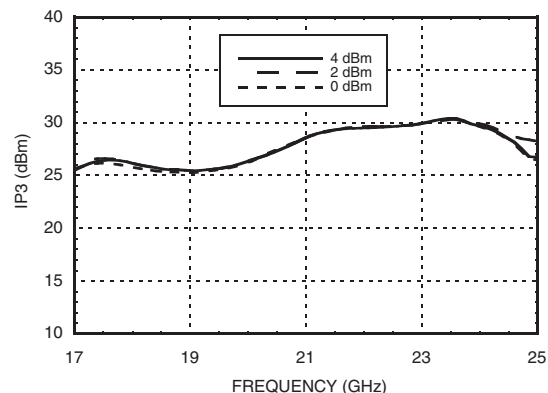

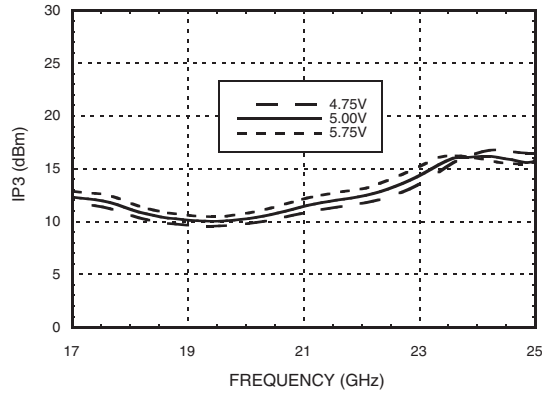
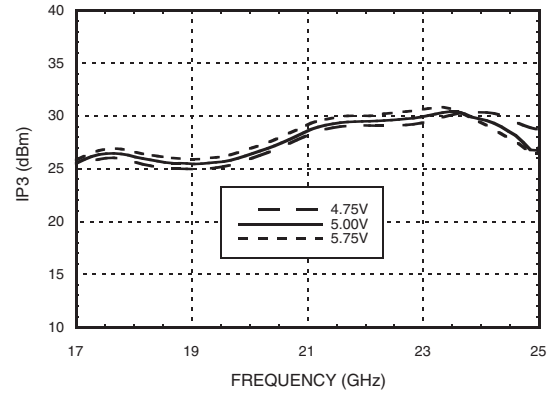
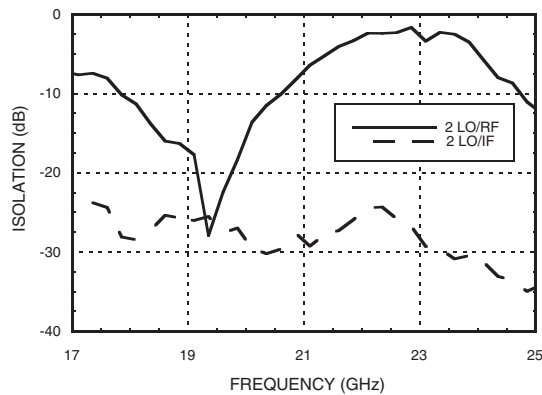
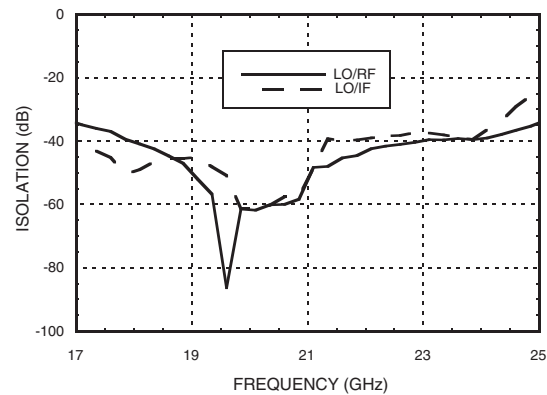
**GaAs MMIC SUB-HARMONIC
UPCONVERTER, 17.7 - 23.6 GHz**
Data Taken as an Upconverter, IF = 1900 MHz
Input IP3, LSB vs. Vdd

Output IP3, LSB vs. Vdd

Isolations with 2LO

Isolations with LO

GaAs MMIC SUB-HARMONIC UPCONVERTER, 17.7 - 23.6 GHz

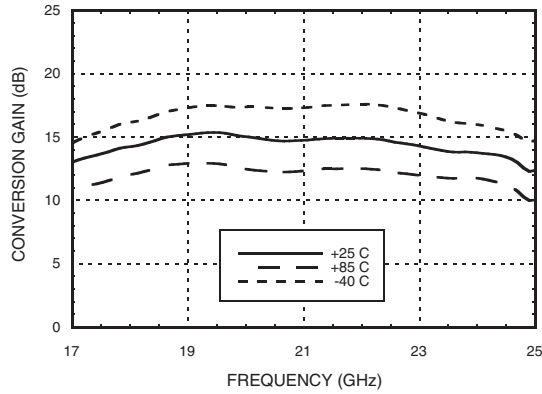

Data Taken as an Upconverter, IF = 2900 MHz

Conversion Gain, LSB vs. Temperature



Conversion Gain, LSB vs. LO Drive

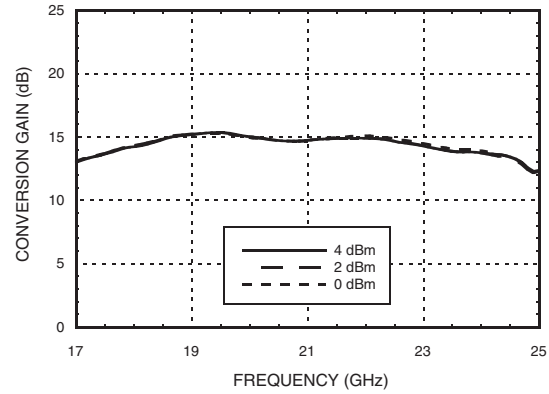

Conversion Gain, LSB vs. Vdd

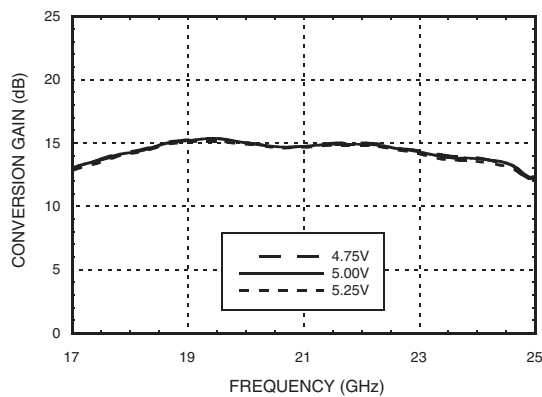

Input IP3, LSB vs. Temperature

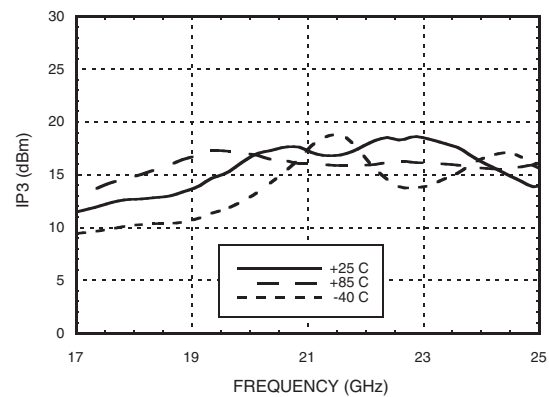

Output IP3, LSB vs. Temperature

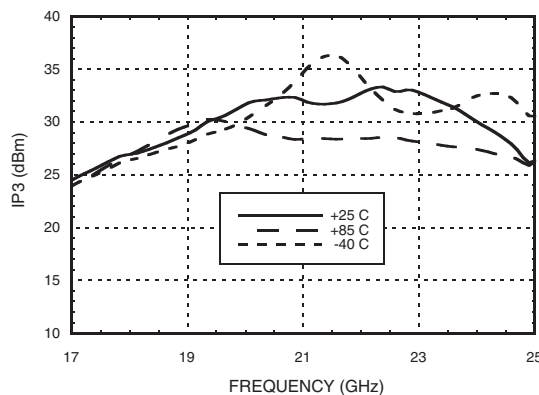



GaAs MMIC SUB-HARMONIC UPCONVERTER, 17.7 - 23.6 GHz

Data Taken as an Upconverter, IF = 1900 MHz

Conversion Gain, USB vs. Temperature

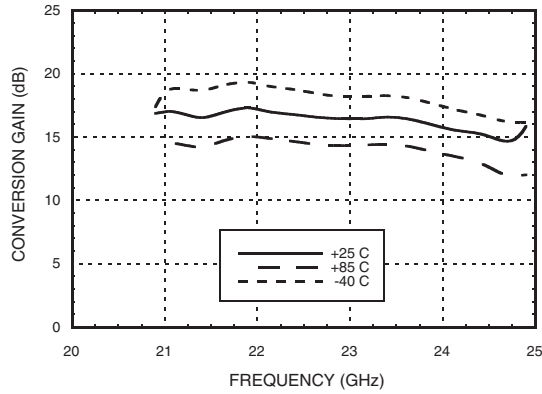

Conversion Gain, USB vs. LO Drive

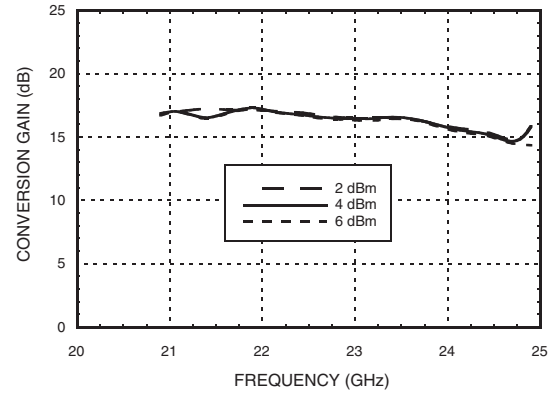

Conversion Gain, USB vs. Vdd

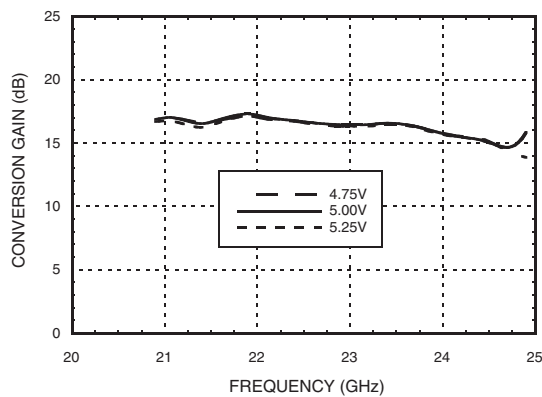

Input P1dB, USB vs. Temperature

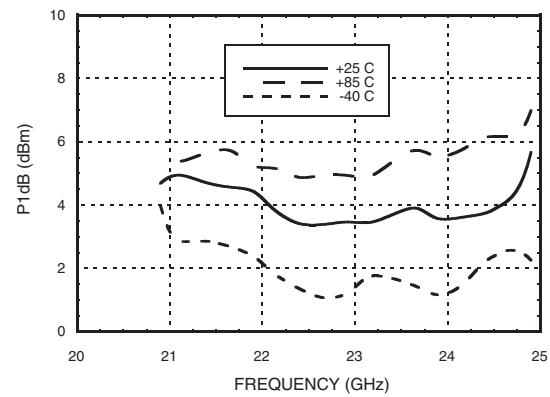

Output P1dB, USB vs. Temperature

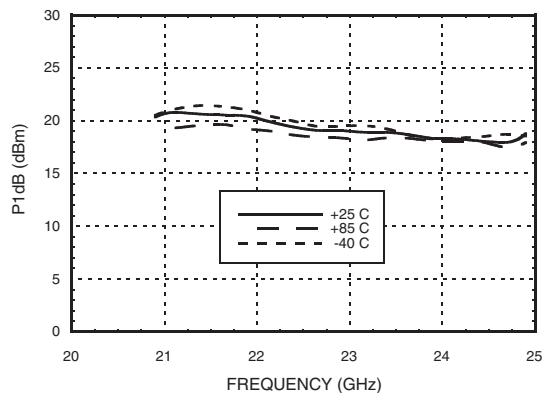

Input IP3, USB vs. Temperature

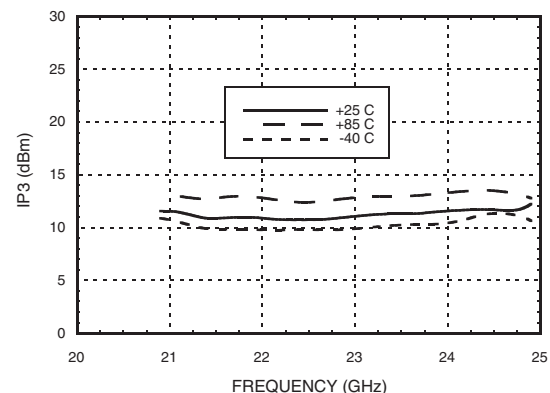



GaAs MMIC SUB-HARMONIC UPCONVERTER, 17.7 - 23.6 GHz

Data Taken as an Upconverter, IF = 1900 GHz

Input IP3, USB vs. Temperature

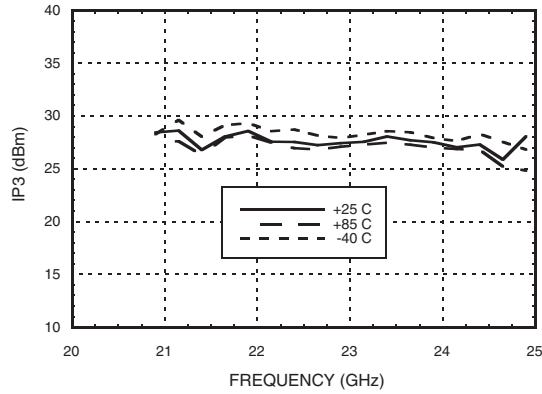

Input IP3, USB vs. LO Drive

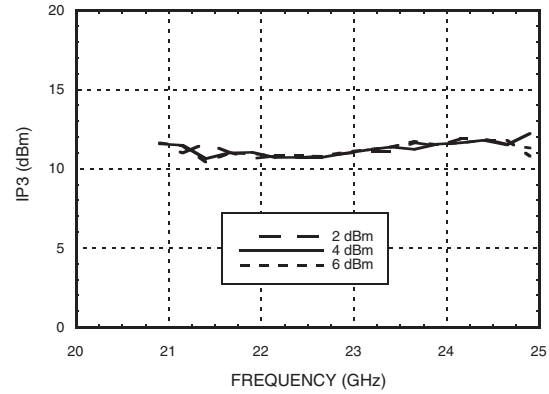

Output IP3, USB vs. Temperature

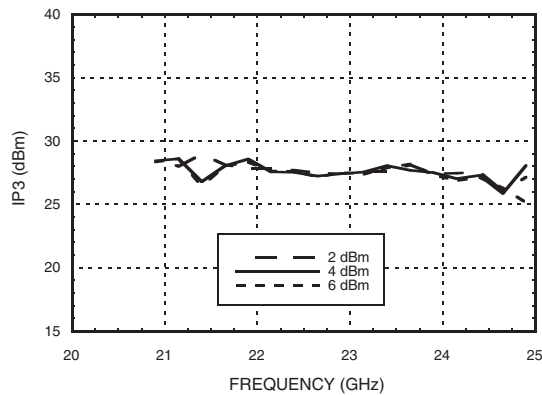

Input IP3, USB vs. Vdd

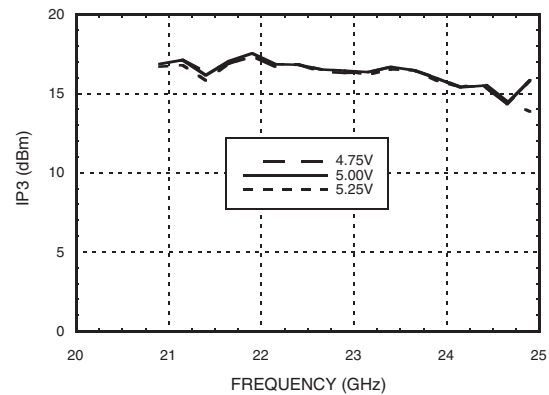

Output IP3, USB vs. Vdd

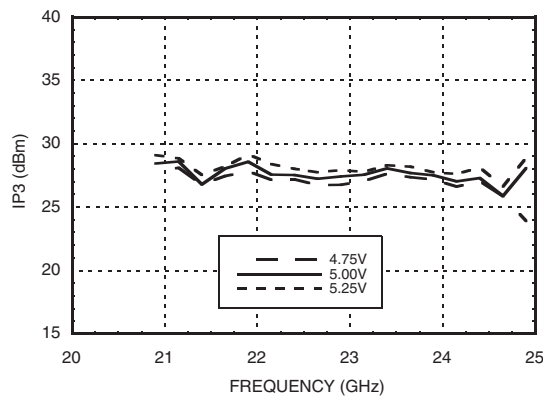



GaAs MMIC SUB-HARMONIC UPCONVERTER, 17.7 - 23.6 GHz

Data Taken as an Upconverter, IF = 3350 MHz

Conversion Gain, USB vs. Temperature

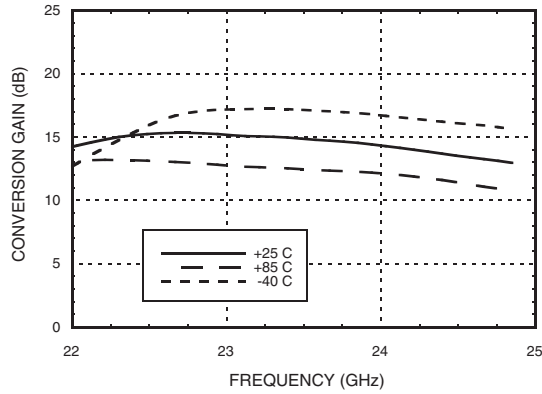

Conversion Gain, USB vs. LO Drive

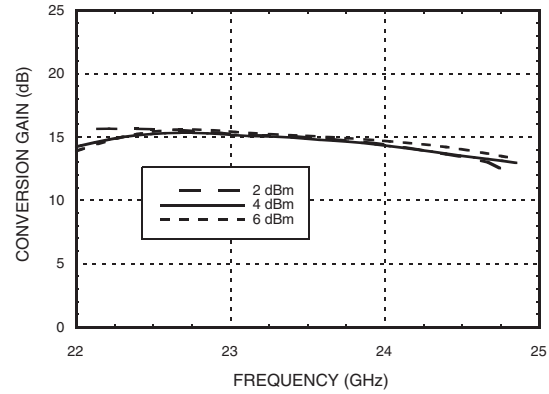

Conversion Gain, USB vs. Vdd

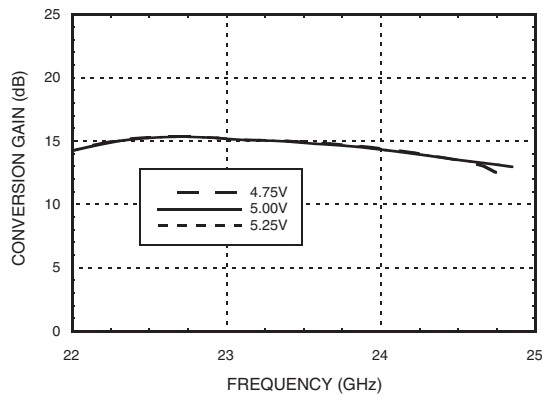

Input IP3, USB vs. Temperature

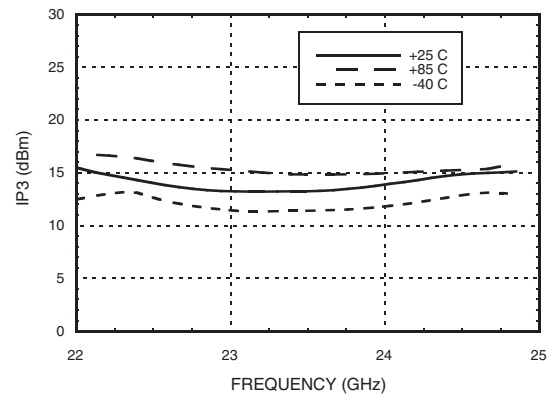

Output IP3, USB vs. Temperature

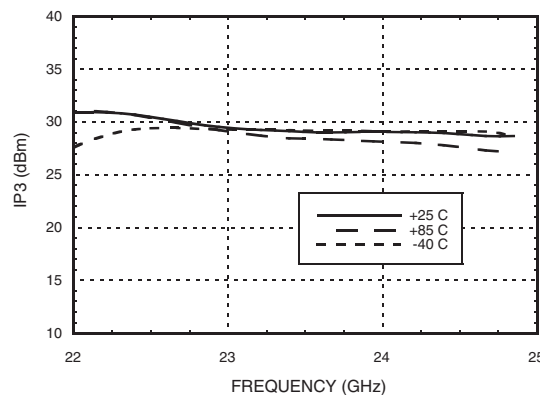



GaAs MMIC SUB-HARMONIC UPCONVERTER, 17.7 - 23.6 GHz

MxN Spurious Outputs [1]

mIF	nLO				
	0	1	2	3	4
0	x	-60.52	-8.80	-24.52	-45.52
+1	-65.52	-46.52	0.00	-44.52	-56.52
+2	-60.52	-55.52	-56.52	-72.52	-54.52
+3	-79.52	-50.52	-47.52	-48.52	-79.52
+4	-72.52	-2.53	-25.52	-50.52	-74.52

IF = 1.9 GHz @ -10 dBm
LO = 9.5 GHz @ 4 dBm

MxN Spurious Outputs [1]

mIF	nLO				
	0	1	2	3	4
0	x	-58	-10.3	-39	-47
+1	-64	-49	0	-62	-60
+2	-61	-60	-53	-80	-62
+3	-100	-80	-53	-99	-104
+4	-97	-90	-96	NM	-108

IF = 1.9 GHz @ -10 dBm
LO = 10 GHz @ 4 dBm

MxN Spurious Outputs [1]

mIF	nLO				
	0	1	2	3	4
0	x	-58.8	-13.8	-45.8	-50.8
+1	-69.8	-47.8	0	-75.8	-68.8
+2	-63.8	-68.8	-64.8	-84.8	-58.8
+3	-103.8	-91.8	-55.8	-106.8	NM
+4	-98.8	-92.8	-96.8	NM	NM

IF = 1.9 GHz @ -10 dBm
LO = 10.5 GHz @ 4 dBm

MxN Spurious Outputs [1]

mIF	nLO				
	0	1	2	3	4
0	x	-55.68	-26.68	-52.68	-48.68
+1	-86.68	-46.68	0	-101.68	-77.68
+2	-60.68	-72.68	-68.68	-84.68	-61.68
+3	-113.68	-85.68	-67.68	NM	NM
+4	-99.68	-93.68	-111.68	NM	xx

IF = 1.9 GHz @ -10 dBm
LO = 11 GHz @ 4 dBm

MxN Spurious Outputs [2]

mIF	nLO				
	0	1	2	3	4
0	x	-55.69	-9.29	-38.69	-47.69
-1	-65.69	-95.69	0	-49.69	-57.69
-2	-51.69	-91.69	-58.69	-51.69	-49.69
-3	-97.69	-113.69	-64.69	-79.69	-98.69
-4	-92.69	NM	-110.69	-95.69	-97.69

IF = 2.9 GHz @ -10 dBm
LO = 10.25 GHz @ 4 dBm

MxN Spurious Outputs [2]

mIF	nLO				
	0	1	2	3	4
0	x	-55.59	-16.59	-47.59	-46.59
-1	-73.59	-96.59	0	-53.59	-66.59
-2	-52.59	-91.59	-69.59	-62.59	-51.59
-3	-106.59	-115.59	-65.59	-75.59	-99.59
-4	-95.59	-122.59	-109.59	-96.59	-94.59

IF = 2.9 GHz @ -10 dBm
LO = 10.75 GHz @ 4 dBm

[1] All values in dBc below RF power level (2LO + IF) USB

[2] All values in dBc below RF power level (2LO + IF) LSB



GaAs MMIC SUB-HARMONIC UPCONVERTER, 17.7 - 23.6 GHz

MxN Spurious Outputs [2]

mIF	nLO				
	0	1	2	3	4
0	x	-53.63	-22.63	-50.63	-47.63
-1	-84.63	-101.63	0	-63.63	-73.63
-2	-58.63	-90.63	-65.63	-86.63	-57.63
-3	-110.63	-120.63	-62.63	-73.63	-102.63
-4	-100.63	NM	NM	-91.63	NM

IF = 2.9 GHz @ -10 dBm
LO = 11.25 GHz @ 4 dBm

MxN Spurious Outputs [2]

mIF	nLO				
	0	1	2	3	4
0	x	-47.72	-10.22	-52.72	-49.72
-1	-73.72	-97.72	0	-68.72	-70.72
-2	-62.72	-87.72	-57.72	-94.72	-55.72
-3	-112.72	NM	-63.72	-91.72	-109.72
-4	-109.72	NM	-117.72	-94.72	-110.72

IF = 2.9 GHz @ -10 dBm
LO = 11.75 GHz @ 4 dBm

MxN Spurious Outputs [2]

mIF	nLO				
	0	1	2	3	4
0	x	-40.7	-4.6	-3.44	-64.9
-1	-68.9	-89.9	0	-72.9	-59.9
-2	-67.9	-85.9	-63.9	NM	-63.9
-3	NM	NM	-66.9	NM	NM
-4	NM	NM	NM	NM	NM

IF = 2.9 GHz @ -10 dBm
LO = 12.25 GHz @ 4 dBm

MxN Spurious Outputs [2]

mIF	nLO				
	0	1	2	3	4
0	x	-37.7	-1.8	-64.2	xx
-1	-68.2	-85.2	0	-76.2	-67.2
-2	-71.2	-86.2	-57.2	NM	-66.2
-3	NM	NM	-68.2	NM	NM
-4	NM	NM	NM	NM	NM

IF = 2.9 GHz @ -10 dBm
LO = 12.75 GHz @ 4 dBm

MxN Spurious Outputs [2]

mIF	nLO				
	0	1	2	3	4
0	x	-40.8	-3	-65.1	xx
-1	-79.1	-84.1	0	NM	xx
-2	-80.1	-91.1	-85.1	NM	-62.1
-3	NM	NM	-71.1	NM	NM
-4	NM	NM	NM	NM	NM

IF = 2.9 GHz @ -10 dBm
LO = 13.25 GHz @ 4 dBm

[1] All values in dBc below RF power level (2LO + IF) USB
[2] All values in dBc below RF power level (2LO + IF) LSB

Absolute Maximum Ratings

Drain Bias Voltage (Vdd1, 2, 3)	5.5V
Gate Bias Voltage (Vgg)	-2.0V
IF Input Power	+17 dBm
LO Drive	+10 dBm
Channel Temperature	175 °C
Continuous Pdiss (T=85°C) (derate 19.7 mW/°C above 85°C)	1.78 W
Thermal Resistance (R _{TH}) (channel to package bottom)	50.7 °C/W
Storage Temperature	-65 to +150 °C
Operating Temperature	-40 to +85 °C



ELECTROSTATIC SENSITIVE DEVICE
OBSERVE HANDLING PRECAUTIONS

Outline Drawing

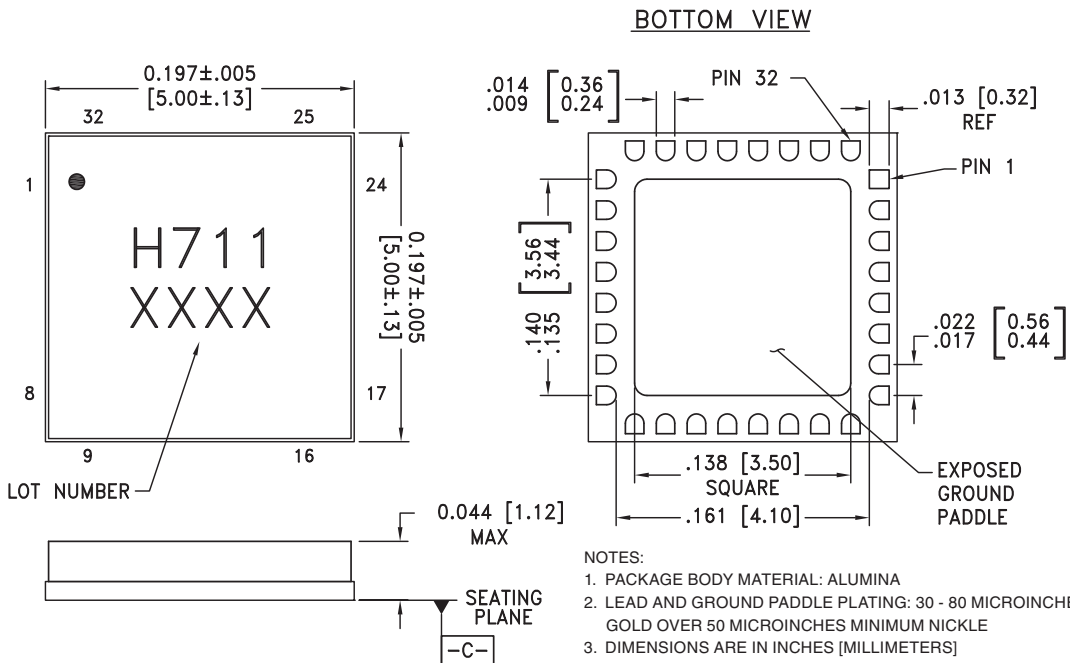

- NOTES:
1. PACKAGE BODY MATERIAL: ALUMINA
 2. LEAD AND GROUND PADDLE PLATING: 30 - 80 MICROINCHES GOLD OVER 50 MICROINCHES MINIMUM NICKLE
 3. DIMENSIONS ARE IN INCHES [MILLIMETERS]
 4. LEAD SPACING TOLERANCE IS NON-CUMULATIVE
 5. PACKAGE WARP SHALL NOT EXCEED 0.05mm DATUM
 6. ALL GROUND LEADS AND GROUND PADDLE MUST BE SOLDERED TO PCB RF GROUND

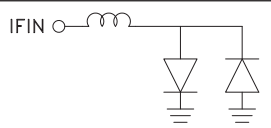
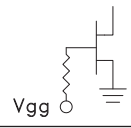
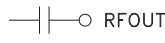
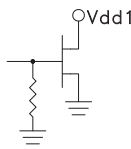
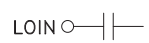
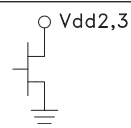

Pin Descriptions

Pin Number	Function	Description	Interface Schematic
1 - 3, 7 - 12, 14 - 17, 23 - 26, 28, 31, 32	N/C	The pins are not connected internally; however, all data shown herein was measured with these pins connected to RF/DC ground externally.	
4, 6, 18, 20, 30	GND	These pins and the package bottom must be connected to RF/DC ground.	
5	IFIN	This pin is DC coupled. For applications not requiring operation to DC, this port should be DC blocked externally using a series capacitor whose value has been chosen to pass the necessary IF frequency range. For operation to DC, this pin must not source or sink more than 2 mA of current or part non-function and possible part failure will result.	
13	Vgg	Gate control for RF amplifier, please follow "MMIC Amplifier Biasing Procedure" application note. See application circuit for required external components	
19	RFOUT	This pin is AC coupled and matched to 50 Ohms.	
27	Vdd1	Power supply voltage for x2 multiplier. See application circuit for required external components.	
29	LOIN	This pin is AC coupled and matched to 50 Ohms.	
22, 21	Vdd2, Vdd3	Power supply voltage for RF amplifier. See application circuit for required external components.	

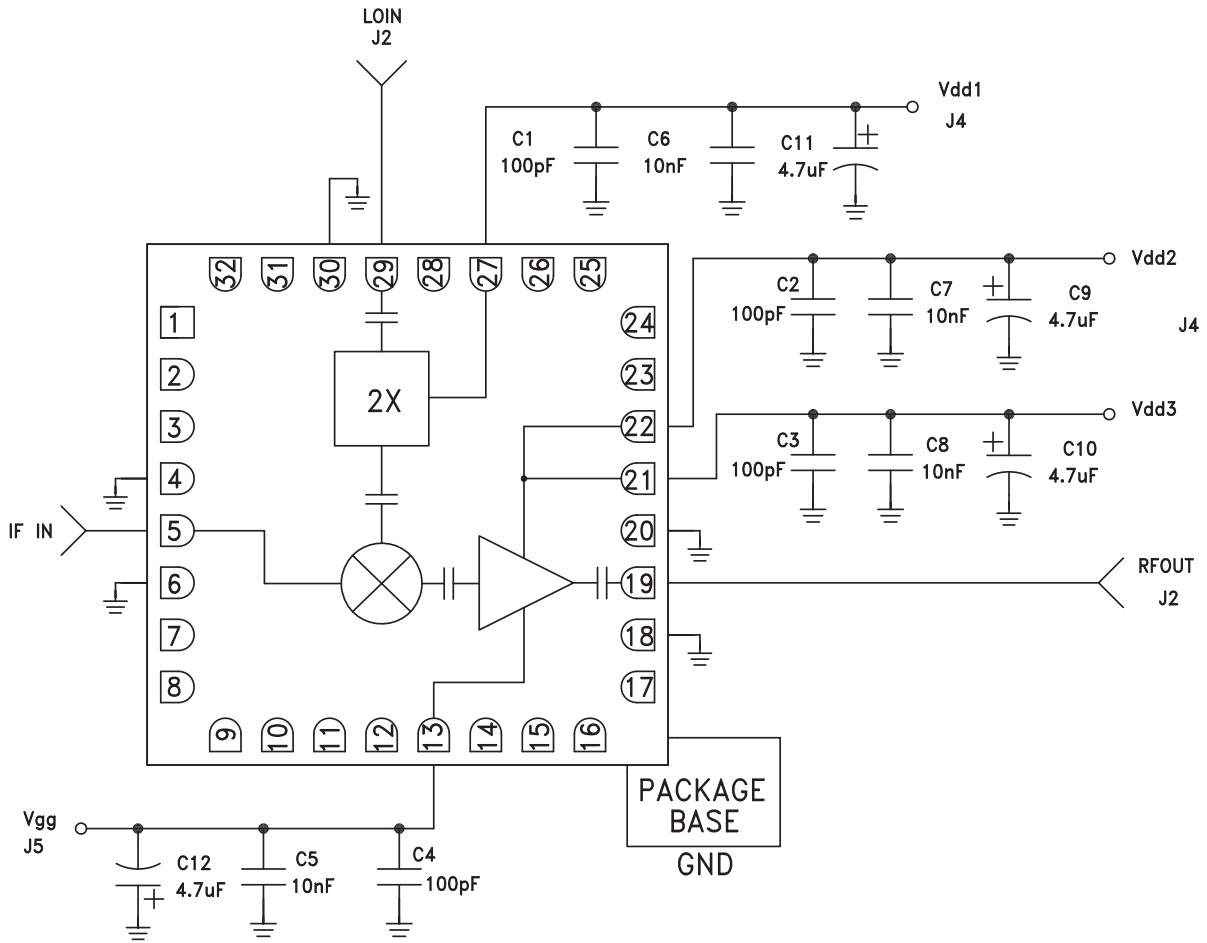
Application Circuit

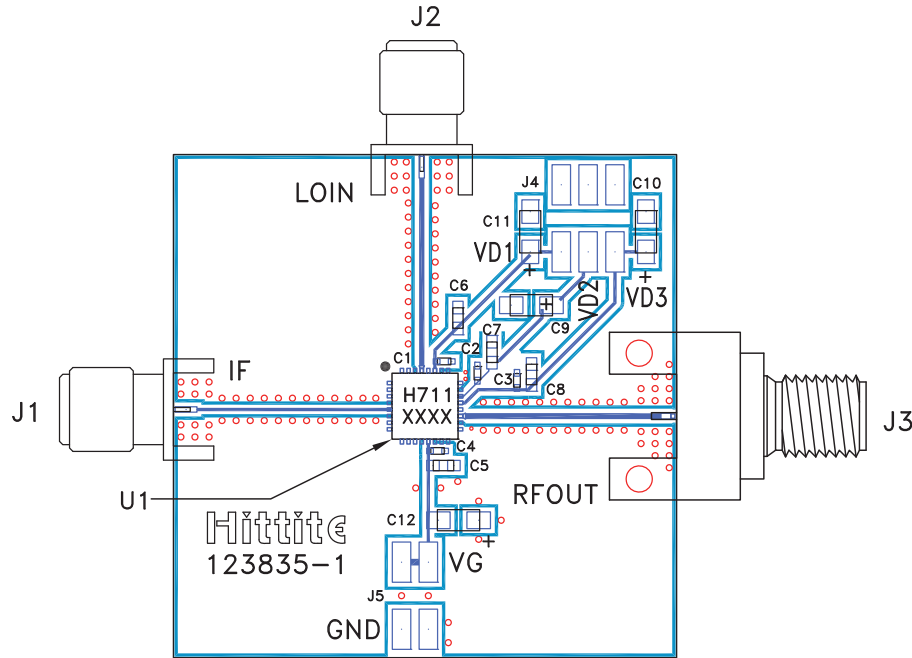

Evaluation PCB



List of Materials for Evaluation PCB 127912 [1]

Item	Description
J1, J2	PCB Mount SMA Connector
J3	PCB Mount K Connector
J4, J5	2mm Molex DC Connector
C1 - C4	100 pF Capacitor, 0402 Pkg.
C5 - C8	10 nF Capacitor, 0603 Pkg.
C9 - C12	4.7 μ F Tantalum Capacitor Case A
U1	HMC711LC5 Upconverter
PCB [2]	123835 Evaluation Board

[1] Reference this number when ordering complete evaluation PCB

[2] Circuit Board Material: Rogers 4350 or Arlon 25FR

The circuit board used in the final application should use RF circuit design techniques. Signal lines should have 50 Ohm impedance while the package ground leads and exposed paddle should be connected directly to the ground plane similar to that shown. A sufficient number of via holes should be used to connect the top and bottom ground planes. The evaluation circuit board shown is available from Hittite upon request.