

### Typical Applications

The HMC862LP3E is ideal for:

- Satellite Communication Systems
- Point-to-Point & Point-to-Multi-Point Radios
- Military Applications
- Test Equipment

### Functional Diagram

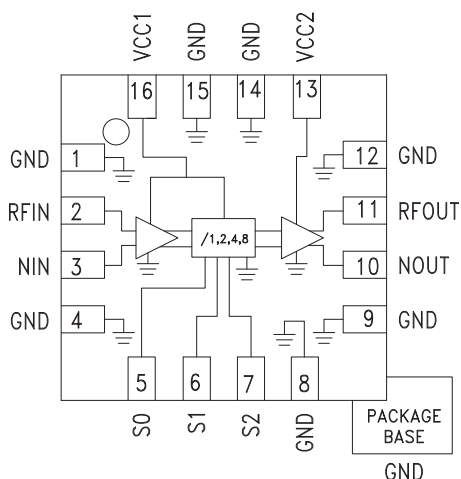

### Features

- Low Noise Floor: -153 dBc/Hz at 100 kHz offset
- Programmable Frequency Divider, N = 1, 2, 4, 8
- Wide Bandwidth: 100 MHz to 15 GHz
- 16 Lead 3X3 mm SMT Package: 9mm<sup>2</sup>

### General Description

The HMC862LP3E is a low noise programmable frequency divider in a 3x3 mm leadless surface mount package. The divider can be programmed to divide from N=1, 2, 4, 8 in the 100 MHz to 15 GHz input frequency range. The low phase noise, wide frequency range and flexible division ratio make this device ideal for high performance and wide band communication systems.

### Electrical Specifications, $T_A = +25^\circ\text{C}$ , $V_{CC1} = V_{CC2} = +5V$

Parameter	Conditions	Min.	Typ.	Max.	Units
<b>RF Input Characteristics</b>					
Max RF Input Frequency	Sine Wave or Square Wave Input	15			GHz
Min RF Input Frequency	Sine Wave or Square Wave Input [1]			0.1	GHz
RF Input Power Range (N = 1)	Sine Wave or Square Wave Input [1][2] Fin < 8 GHz	-10		10	dBm
	Sine Wave or Square Wave Input [1][2] Fin > 8 GHz	-10		0	dBm
RF Input Power Range (N = 2, 4, 8)	Sine Wave or Square Wave Input [1]	-10		10	dBm
<b>Divider Output Characteristics</b>					
Output Power (N = 1)	(see the Pout plot for N = 1) [2]		-2 to +3		dBm
Output Power (N = 2, 4, 8)	(see the Pout plots for each division ratio)		2		dBm
Divider Ratio N			1, 2, 4, 8		
SSB Phase Noise @ 100 kHz Offset	Fin = 6 GHz, Pin = 0 dBm, N = 2		-153		dBc/Hz
<b>Logic Inputs</b>					
VIH Input High Voltage		3		5	V
VIL Input Low Voltage		0		0.4	V
<b>Power Supplies</b>					
Vcc	Analog Supply	4.75	5	5.25	V
<b>Current Consumption</b>					
Icc	N = 1, S0 = L, S1 = L, S2 = L		106		mA
	N = 2, S0 = H, S1 = L, S2 = L		143		mA
	N = 4, S0 = H, S1 = H, S2 = L		153		mA
	N = 8, S0 = H, S1 = H, S2 = H		162		mA
Control Bits			3		Bit

[1] Square wave input waveform is recommended below 400 MHz for best phase noise performance. If sine wave input waveform is used below 400 MHz, it is recommended that power input is > +5 dBm for best operation including phase noise performance.

[2] For N = 1, frequencies > 8 GHz, and input power > 0 dBm, output power will saturate and gradually drop with increasing input power, but part will continue to function.



**0.1 - 15 GHz LOW NOISE PROGRAMMABLE DIVIDER (N = 1, 2, 4, 8)**

**Divide-by-1**

**Input Sensitivity vs. Temperature**

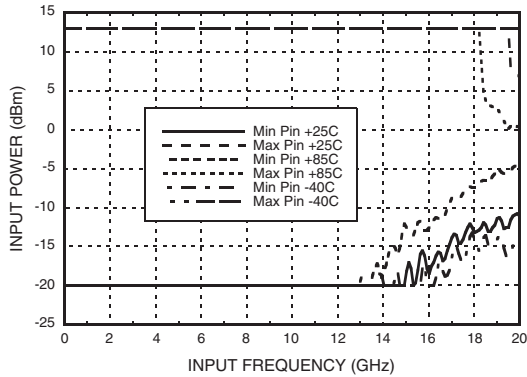

**Output Power vs. Temperature, Pin = 0 dBm**

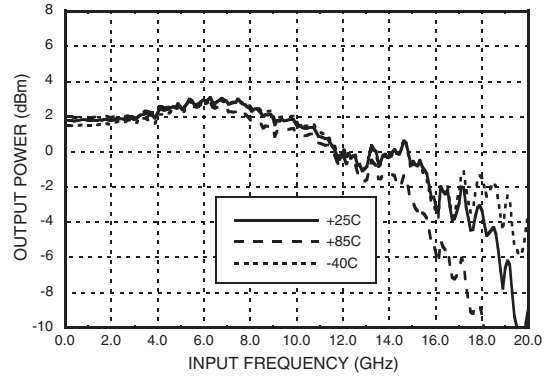

**Phase Noise vs. Frequency, Pin = 0 dBm**

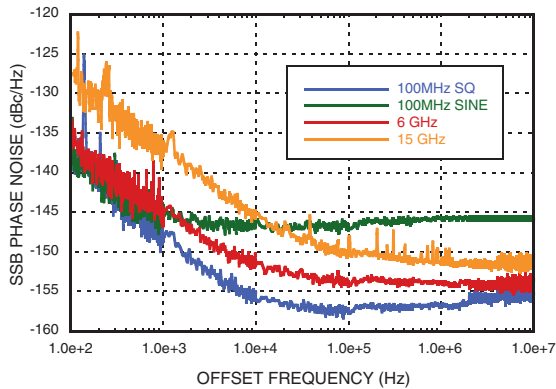

**Phase Noise vs. Temperature, Pin = 0 dBm, Fin = 6 GHz**

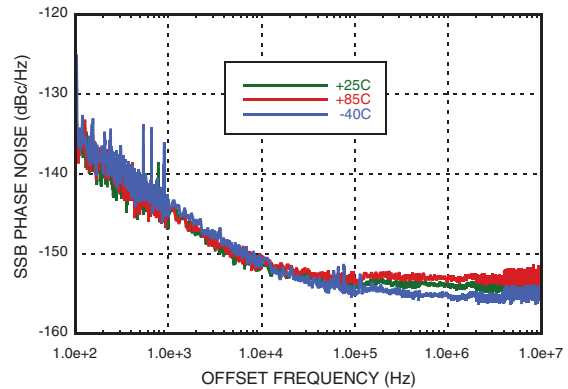

**Output Harmonics, Pin = 0 dBm T = 25 °C**

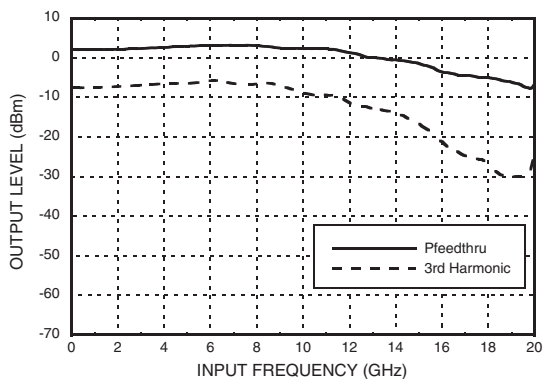

**Reverse Leakage, Pin = 0 dBm T = 25 °C**

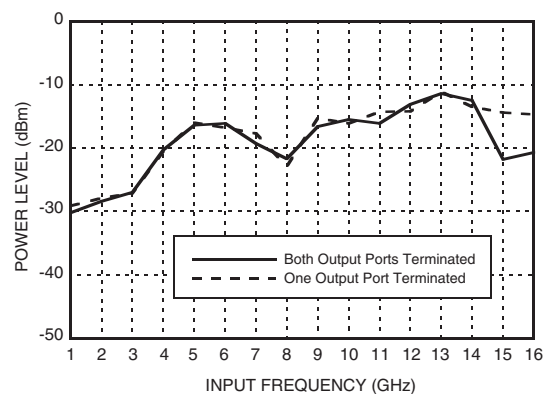



**0.1 - 15 GHz LOW NOISE PROGRAMMABLE  
DIVIDER (N = 1, 2, 4, 8)**

**Divide-by-2**

4

FREQUENCY DIVIDERS & DETECTORS - SMT

**Input Sensitivity vs. Temperature**

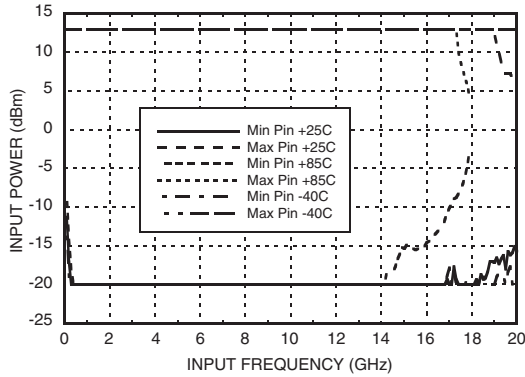

**Output Power vs. Temperature, Pin = 0 dBm**

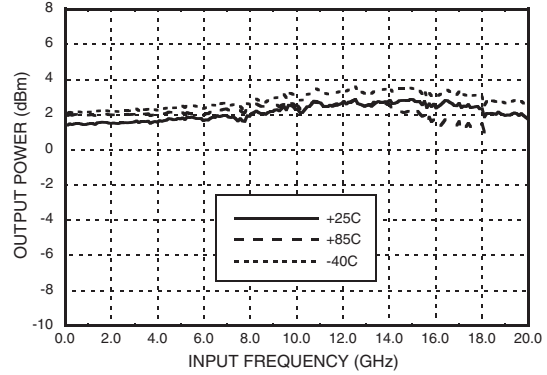

**Phase Noise vs. Frequency, Pin = 0 dBm**

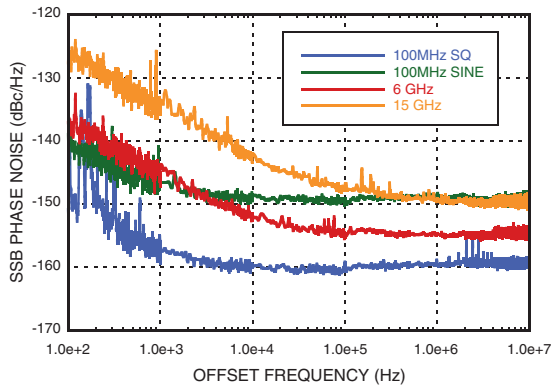

**Phase Noise vs. Temperature  
Pin = 0 dBm, Fin = 6 GHz**

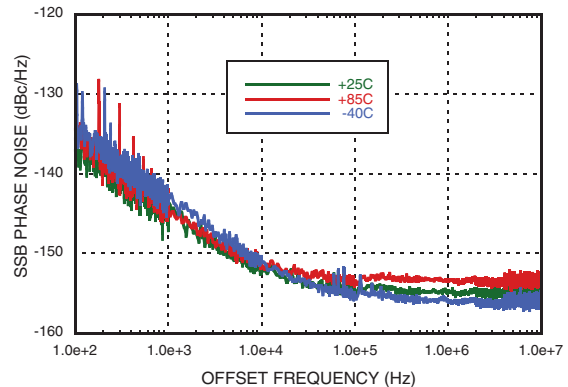

**Output Harmonics, Pin = 0 dBm T = 25 °C**

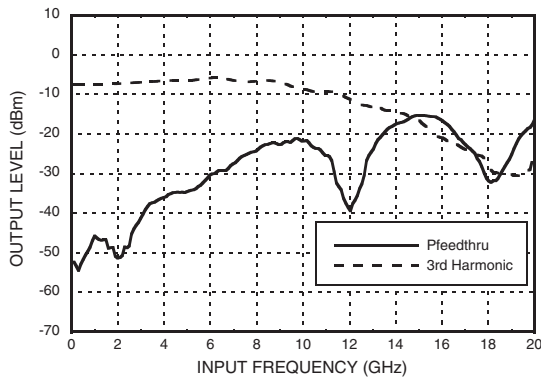

**Reverse Leakage, Pin = 0 dBm T = 25 °C**

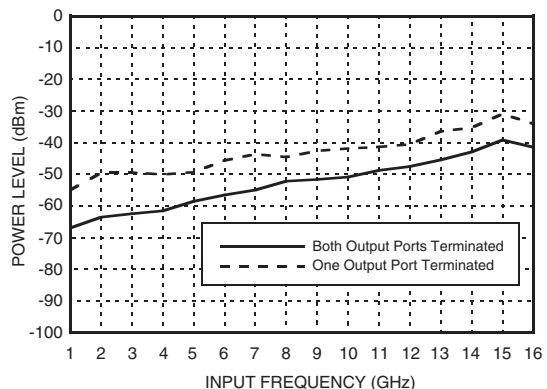



**0.1 - 15 GHz LOW NOISE PROGRAMMABLE  
DIVIDER (N = 1, 2, 4, 8)**

**Divide-by-4**

**Input Sensitivity vs. Temperature**

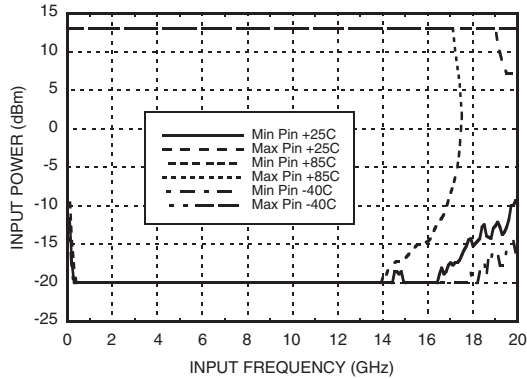

**Output Power vs. Temperature, Pin = 0 dBm**

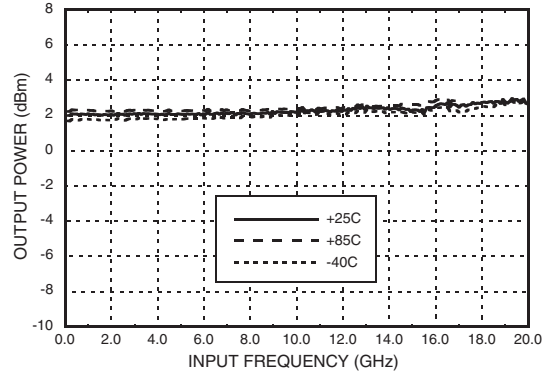

**Phase Noise vs. Frequency, Pin = 0 dBm**

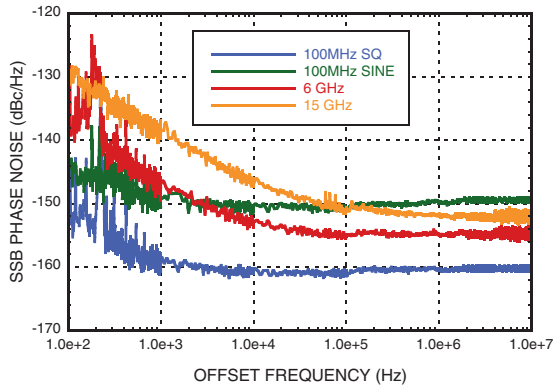

**Phase Noise vs. Temperature  
Pin = 0 dBm, Fin = 6 GHz**

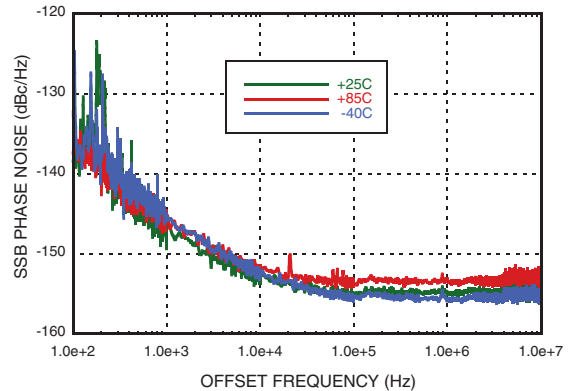

**Output Harmonics, Pin = 0 dBm T = 25 °C**

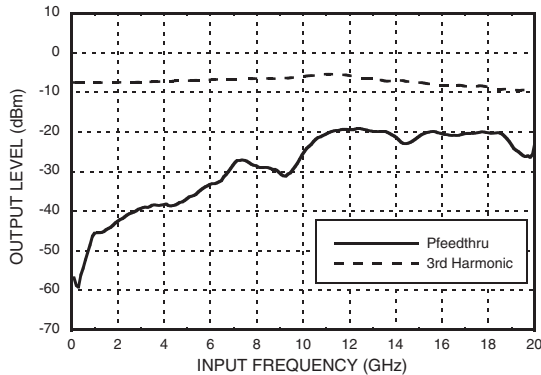

**Reverse Leakage, Pin = 0 dBm T = 25 °C**

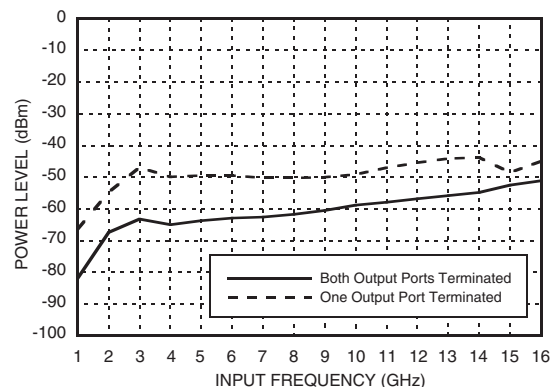



## 0.1 - 15 GHz LOW NOISE PROGRAMMABLE DIVIDER (N = 1, 2, 4, 8)

### Divide-by-8

4

FREQUENCY DIVIDERS & DETECTORS - SMT

**Input Sensitivity vs. Temperature**

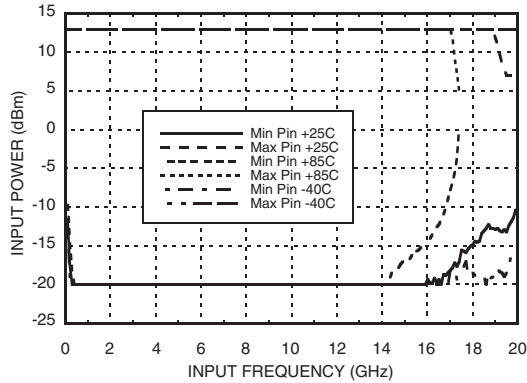

**Output Power vs. Temperature, Pin = 0 dBm**

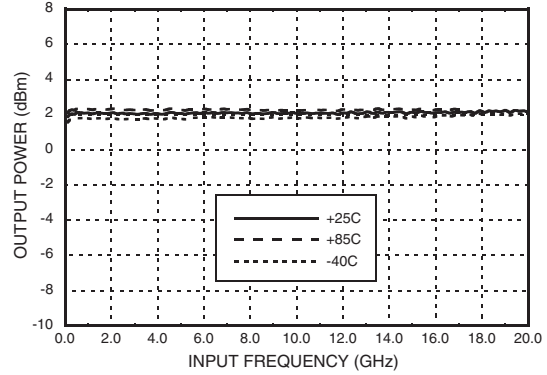

**Phase Noise vs. Frequency, Pin = 0 dBm**

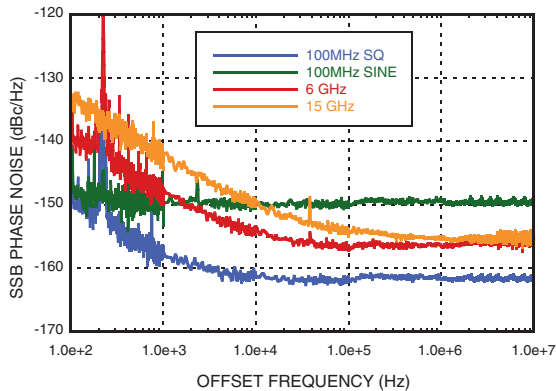

**Phase Noise vs. Temperature  
Pin = 0 dBm, Fin = 6 GHz**

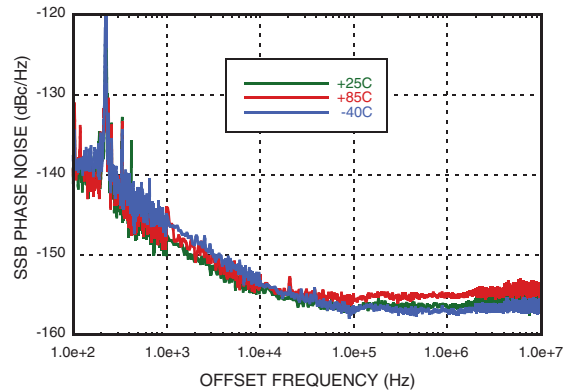

**Output Harmonics, Pin = 0 dBm T = 25 °C**

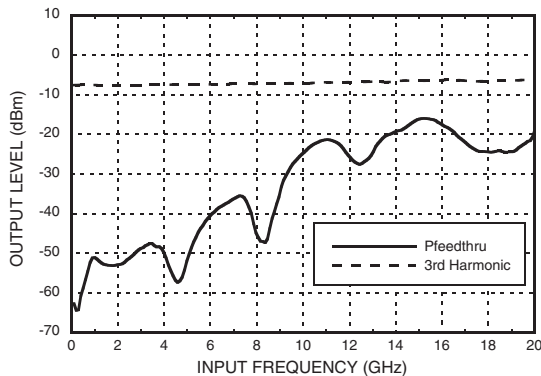

**Reverse Leakage, Pin = 0 dBm T = 25 °C**

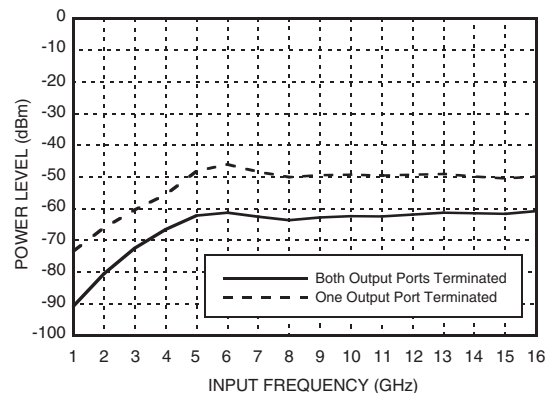



**0.1 - 15 GHz LOW NOISE PROGRAMMABLE DIVIDER (N = 1, 2, 4, 8)**

**I<sub>cc</sub> vs. V<sub>cc</sub>**

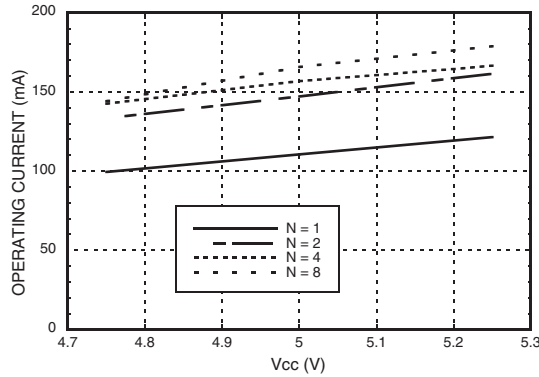

**Programming Truth Table for Frequency Division Ratios**

S0	S1	S2	Divider Ratio (N)
0	0	0	1
1	0	0	2
1	1	0	4
1	1	1	8

0 = Logic Low 1 = Logic High  
Note: V<sub>cc1</sub>, V<sub>cc2</sub> must be applied before logic.

**Digital Control Input Voltages**

State	S0, S1, S2
Low	0 to 0.4V
High	3V to 5V

**Absolute Maximum Ratings**

RF Input Power	13 dBm
Supply Voltage (V <sub>cc</sub> )	5.5V
Logic Inputs (S0, S1, S2)	-0.5V to (0.5V + V <sub>cc</sub> )
Storage Temperature	-65 to +125 °C
ESD Sensitivity (HBM)	Class 1A

**Reliability Information**

Junction Temperature to Maintain 1 Million Hour MTTF	150 °C
Nominal Junction Temperature (T = 85 °C)	112 °C
Thermal Resistance (Junction to GND Paddle, 5V Supply)	33 °C/W
Operating Temperature	-40 to +85 °C



**ELECTROSTATIC SENSITIVE DEVICE  
OBSERVE HANDLING PRECAUTIONS**



**0.1 - 15 GHz LOW NOISE PROGRAMMABLE  
DIVIDER (N = 1, 2, 4, 8)**

**Outline Drawing**

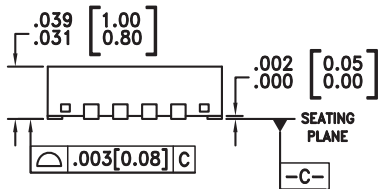
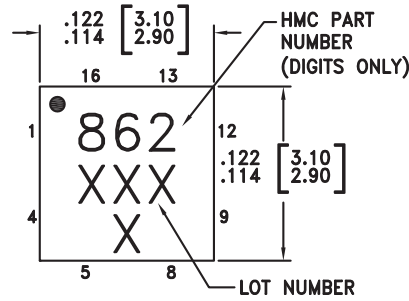

**BOTTOM VIEW**

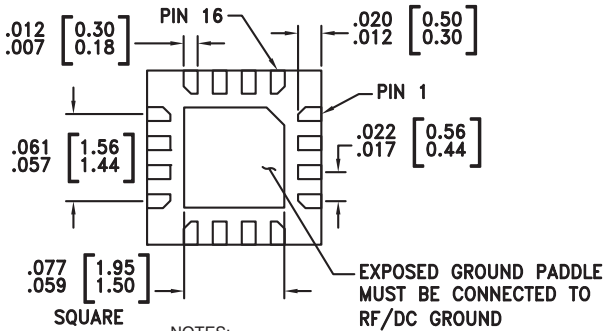

**NOTES:**

1. LEADFRAME MATERIAL: COPPER ALLOY
2. DIMENSIONS ARE IN INCHES [MILLIMETERS].
3. LEAD SPACING TOLERANCE IS NON-CUMULATIVE
4. PAD BURR LENGTH SHALL BE 0.15mm MAXIMUM.  
PAD BURR HEIGHT SHALL BE 0.05mm MAXIMUM.
5. PACKAGE WARP SHALL NOT EXCEED 0.05mm.
6. ALL GROUND LEADS AND GROUND PADDLE MUST BE SOLDERED TO PCB RF GROUND.
7. REFER TO HITTITE APPLICATION NOTE FOR SUGGESTED PCB LAND PATTERN.

**Package Information**

Part Number	Package Body Material	Lead Finish	MSL Rating	Package Marking <sup>[1]</sup>
HMC862LP3E	RoHS-compliant Low Stress Injection Molded Plastic	100% matte Sn	MSL1 <sup>[2]</sup>	862 XXX

[1] 4-Digit lot number XXXX

[2] Max peak reflow temperature of 260 °C



**0.1 - 15 GHz LOW NOISE PROGRAMMABLE  
DIVIDER (N = 1, 2, 4, 8)**

**Pin Description**

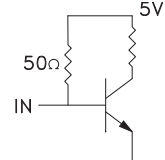
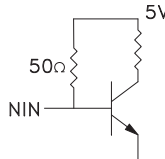
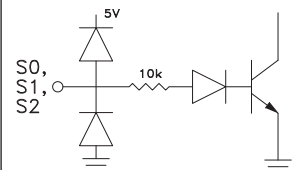
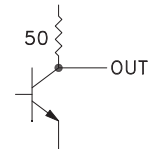
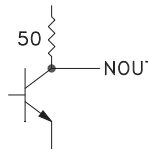
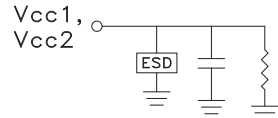
Pin Number	Function	Description	Interface Schematic
1, 4, 8, 9, 12, 14, 15	GND	Ground: Backside of package has exposed metal ground slug which must be connected to RF/DC ground.	
2	IN	RF Input must be DC blocked.	
3	$\overline{\text{NIN}}$	RF Input 180° out of phase with pin 2 for differential operation. AC ground for single ended operation. DC block for differential operation.	
5, 6, 7	S0, S1, S2	CMOS compatible division ratio control bit. See Programming Truth Table	
10	$\overline{\text{NOUT}}$	Divider output 180° out of phase with pin 11. RF output must be DC blocked.	
11	OUT	Divided Output. RF output must be DC blocked.	
13, 16	Vcc1, Vcc2	Supply voltage 5V. Connect both pins to +5V supply.	





## 0.1 - 15 GHz LOW NOISE PROGRAMMABLE DIVIDER (N = 1, 2, 4, 8)

### Evaluation PCB

4

FREQUENCY DIVIDERS & DETECTORS - SMT

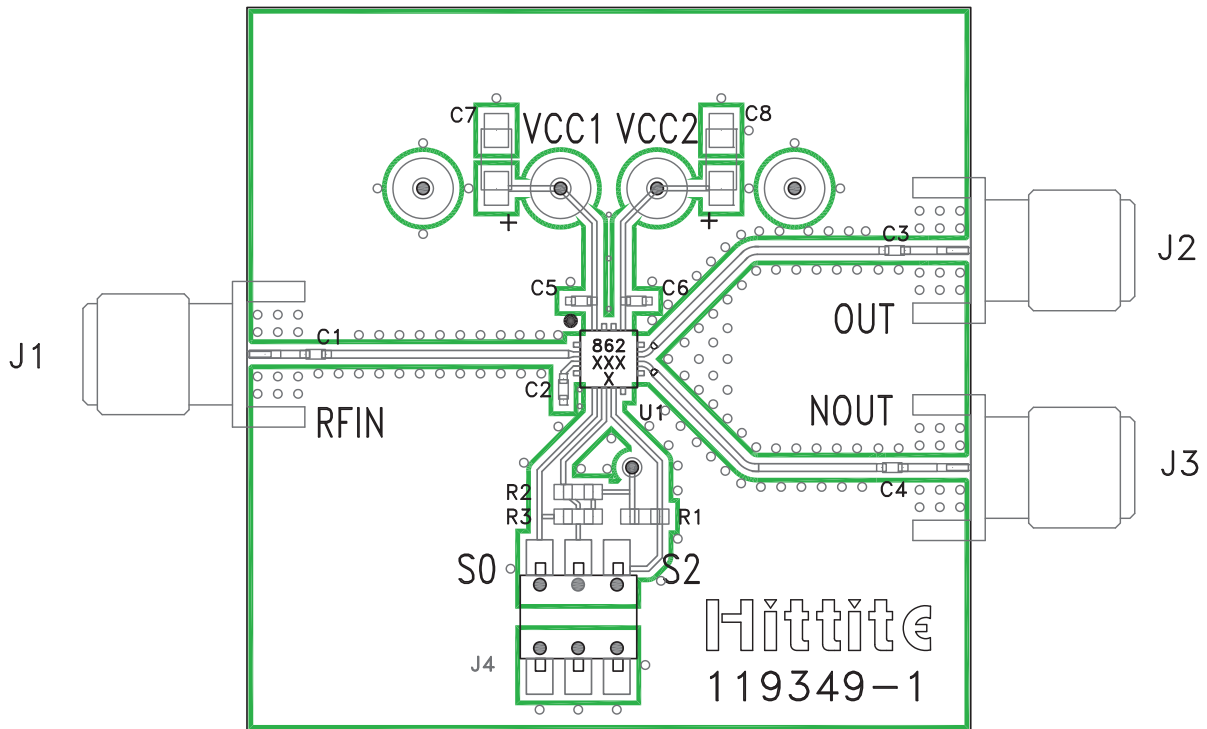

### List of Materials for Evaluation PCB 119351 [1]

Item	Description
J1 - J3	PCB Mount SMA-F RF Connector
J4	DC Connector Header, Molex 2mm
C1 - C4	ATC530L, 100 nF, 16V, Broadband Capacitor, 0402 Pkg.
C5, C6	1000 pF Capacitor, 0402 Pkg.
C7, C8	4.7 μF Capacitor, Tantalum, 1206 Pkg.
R1 - R3	10 kOhm Resistor, 0402 Pkg.
Vcc1, Vcc2	Mill-Max 0.040" Dia. PC Pin, 3101-2-00-21-00-00-08-0
U1	HMC862LP3E, Programmable Divider
PCB [2]	119349 Evaluation Board

[1] Reference this number when ordering complete evaluation PCB

[2] Circuit Board Material: Rogers 4350 or Arlon 25FR

The circuit board used in the application should use RF circuit design techniques. Signal lines should have 50 ohm impedance while the package ground leads and backside ground paddle should be connected directly to the ground plane similar to that shown. A sufficient number of via holes should be used to connect the top and bottom ground planes. The evaluation circuit board shown is available from Hittite upon request.



## 0.1 - 15 GHz LOW NOISE PROGRAMMABLE DIVIDER (N = 1, 2, 4, 8)

### Evaluation PCB Schematic

