

### Typical Applications

The HMC924LC5 is ideal for:

- Point-to-Point and Point-to-Multi-Point Radio
- Military Radar, EW & ELINT
- Satellite Communications
- Sensors

### Features

- High Conversion Gain: 15 dB
- Excellent Sideband Rejection: -30 dBc
- LO / RF Rejection: 15 dBc
- High Input IP3: 14 dBm
- 32 Lead 5x5 mm SMT Ceramic Package: 25 mm<sup>2</sup>

### Functional Diagram

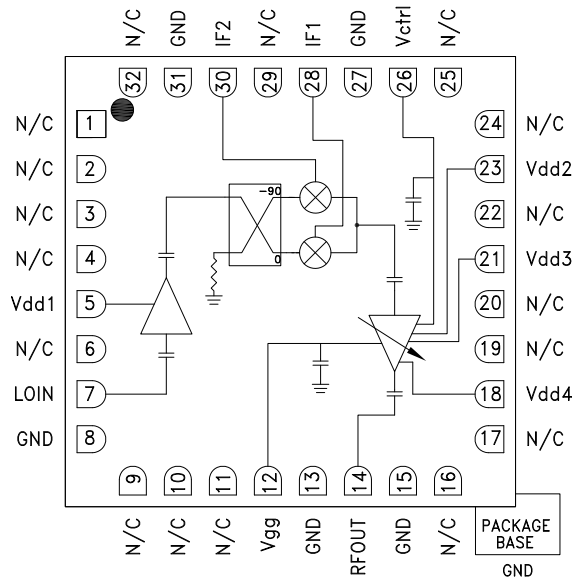

### General Description

The HMC924LC5 is a compact GaAs MMIC I/Q upconverter in a leadless RoHS compliant SMT package. This device provides a small signal conversion gain of 15 dB with -30 dBc of sideband rejection. The HMC924LC5 utilizes a RF amplifier preceded by an I/Q mixer where the LO is driven by a driver amplifier. IF1 and IF2 mixer inputs are provided and an external 90° hybrid is needed to select the required sideband. The I/Q mixer topology reduces the need for filtering of the unwanted sideband. The HMC924LC5 is a much smaller alternative to hybrid style single sideband upconverter assemblies and it eliminates the need for wire bonding by allowing the use of surface mount manufacturing techniques.

### Electrical Specifications, $T_A = +25^\circ\text{C}$ , $IF = 2000\text{ MHz}$ , $IF = -6\text{ dBm}$ , $LO = 0\text{ dBm}$ , $V_{dd1, 4} = +5\text{V}$ , USB <sup>[1][2]</sup>

Parameter	Min.	Typ.	Max.	Min.	Typ.	Max.	Units
Frequency Range, RF		10 - 13			13 - 16		GHz
Frequency Range, LO		7 - 16			10 - 19		GHz
Frequency Range, IF		0 - 3			0 - 3		GHz
Conversion Gain	14	17			15		dB
Sideband Rejection		-30			-20		dBc
1 dB Compression (Output)	19	22		19	22		dBm
LO to RF Rejection <sup>[3]</sup>		15			15		dB
IP3 (Output) at Max Gain		29			27		dBm
Supply Current Idd1 + Idd2 + Idd3 + Idd4 <sup>[2]</sup>		290			290		mA

[1] Unless otherwise noted all measurements performed with low side LO, IF = 2000 MHz and external IF 90° hybrid.

[2] Adjust Vgg between -2 to 0V to achieve Idd2 + Idd3 + Idd4 = 170 mA Typical.

[3] The LO / RF Rejection is defined as the LO signal level at the RF output port relative to the desired RF output signal level.

Data Taken as SSB Upconverter with External IF 90° Hybrid, IF = 2000 MHz

**Conversion Gain, USB vs. Temperature**

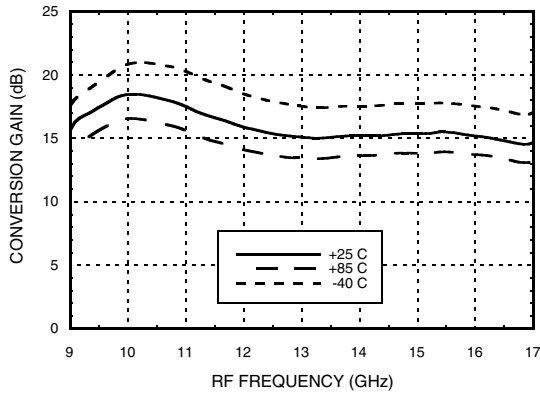

**Conversion Gain, USB vs. LO Drive**

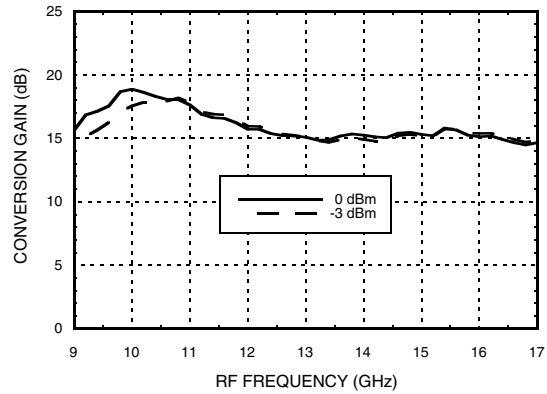

**RF Return Loss vs. Temperature**

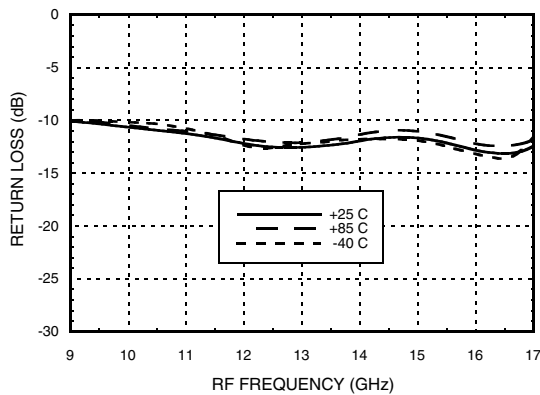

**LO Return Loss vs. Temperature**

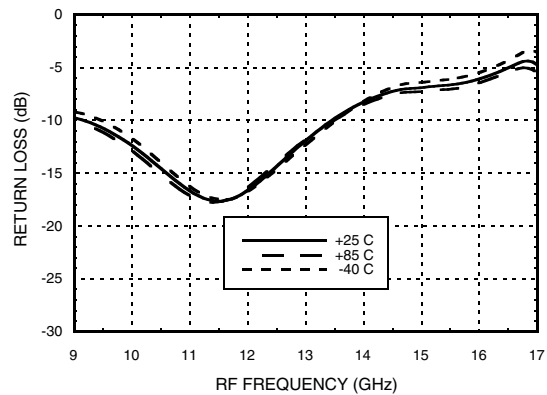

**IF Return Loss [1]**

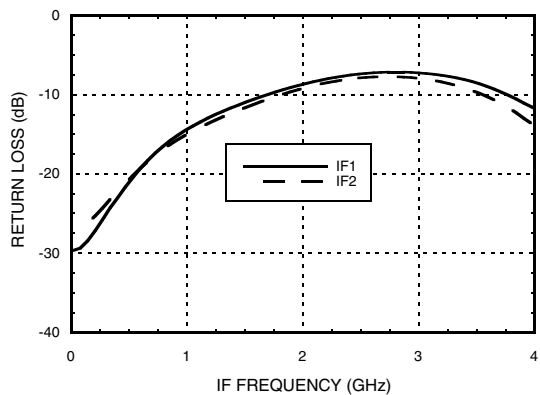

**Side Band Rejection, USB vs. Temperature**

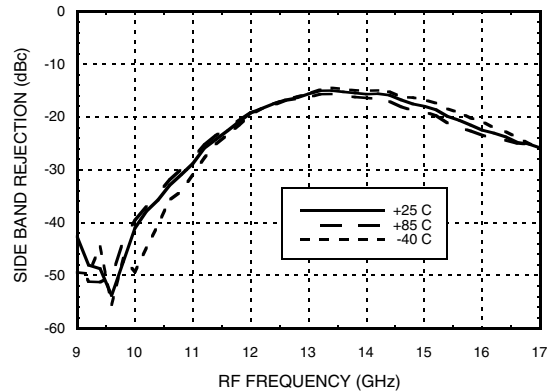

[1] Data taken without external IF 90° hybrid



Data Taken as SSB Upconverter with External IF 90° Hybrid, IF = 2000 MHz

**Input P1dB, USB vs. Temperature**

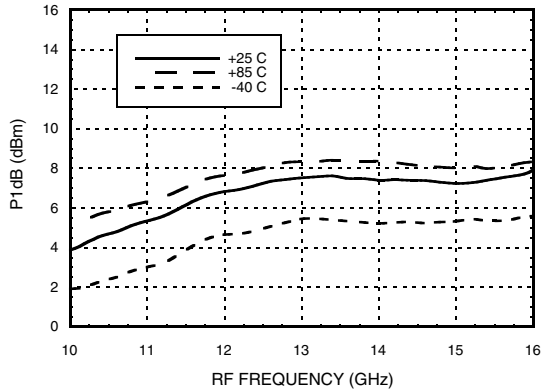

**Output P1dB, USB vs. Temperature**

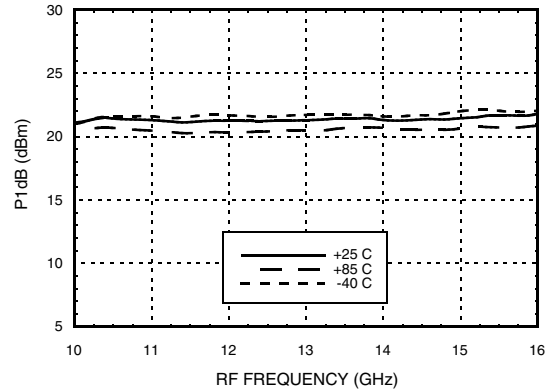

**Input IP3, USB vs. Temperature**

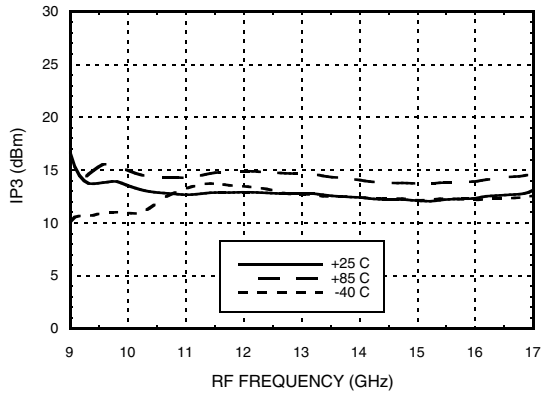

**Output IP3, USB vs. Temperature**

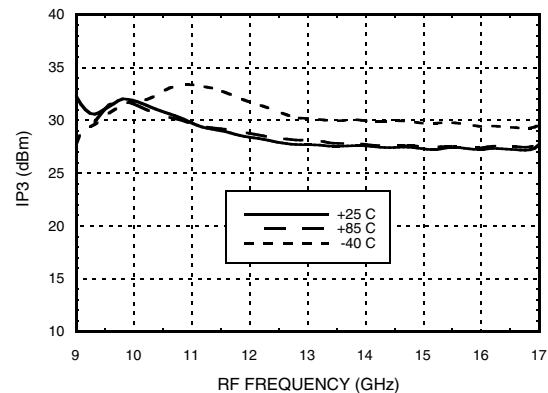

**Conversion Gain, USB vs. Control Voltage**

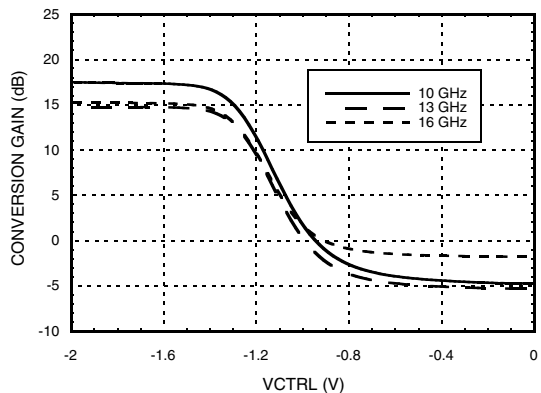

**Input IP3, USB vs. Control Voltage**

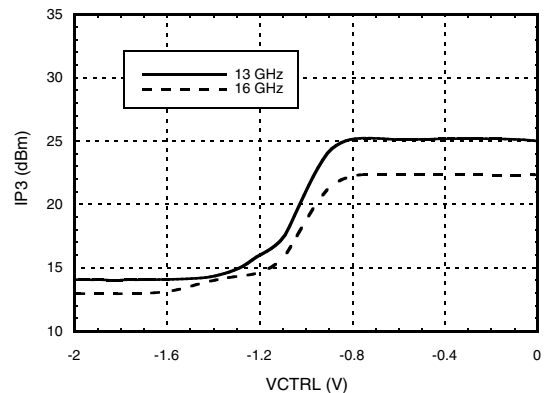



Data Taken as SSB Upconverter with External IF 90° Hybrid, IF = 2000 MHz

LO / RF Rejection, USB vs. Temperature

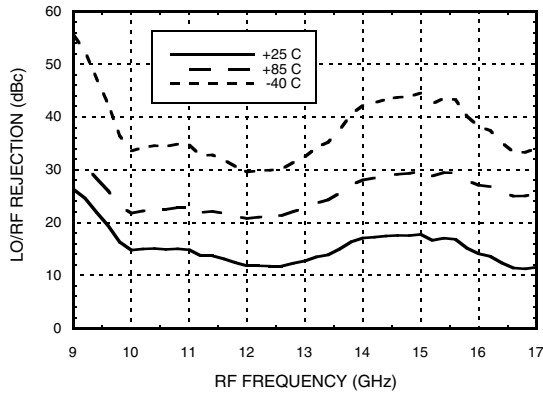

Isolation

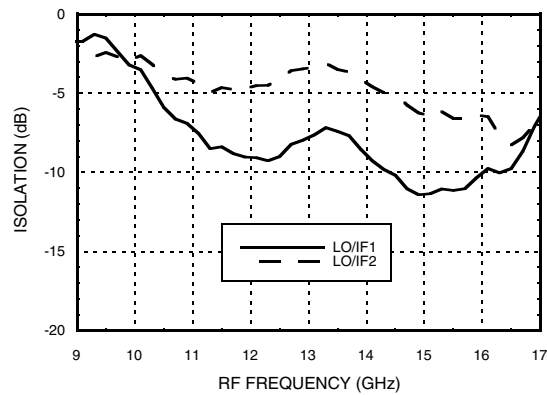

[1] Data taken without external IF 90° hybrid

Data Taken as SSB Upconverter with External IF 90° Hybrid, IF = 2000 MHz

Conversion Gain, LSB vs. Temperature

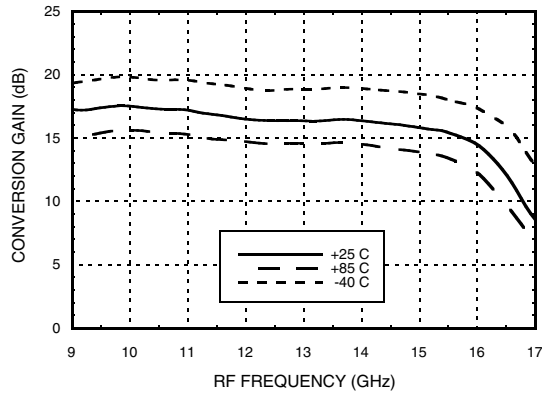

Conversion Gain, LSB vs. LO Drive

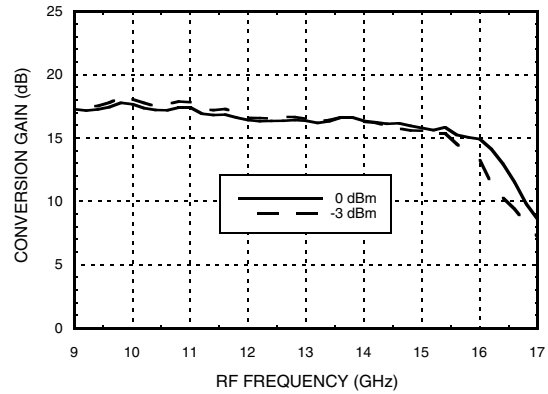

Sideband Rejection, LSB vs. Temperature

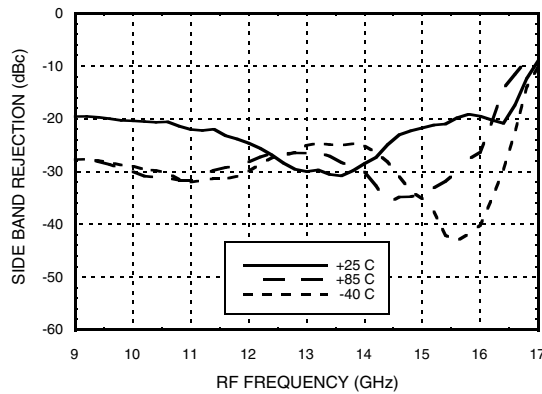

Input P1dB, LSB vs. Temperature

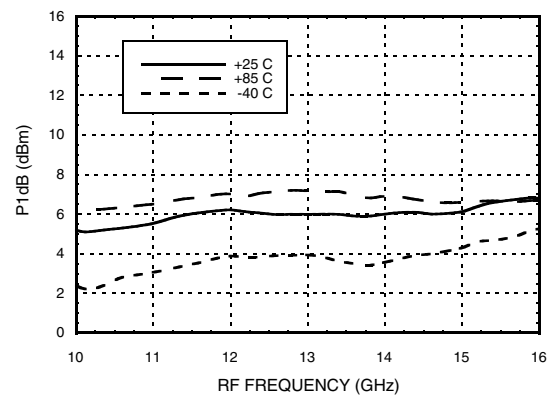

Output P1dB, LSB vs. Temperature

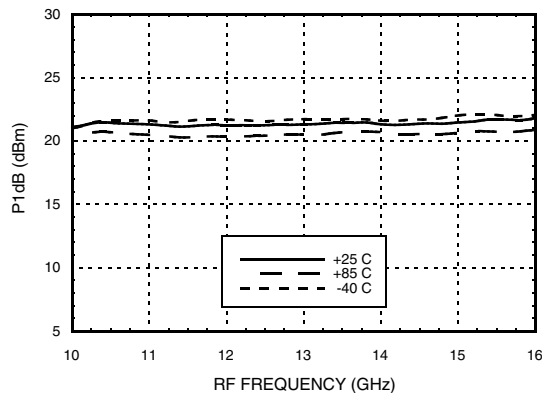

Input IP3, LSB vs. Temperature

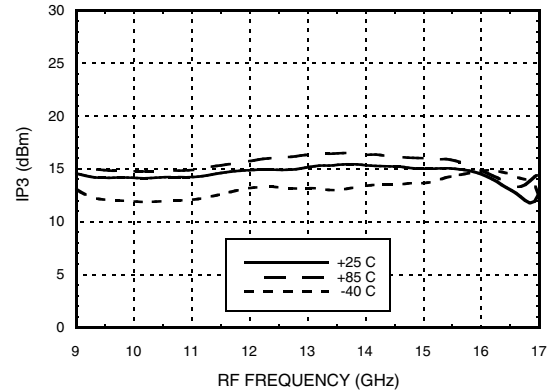

Data Taken as SSB Upconverter with External IF 90° Hybrid, IF = 2000 MHz

**Output IP3, LSB vs. Temperature**

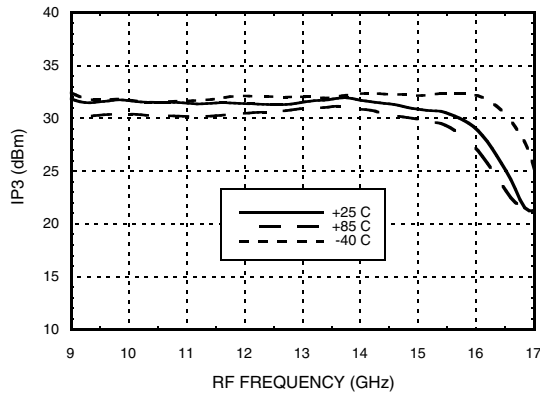

**Conversion Gain, LSB vs. Control Voltage**

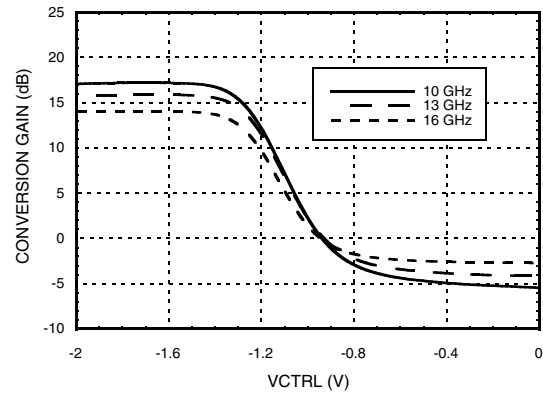

**LO/RF Rejection, LSB**

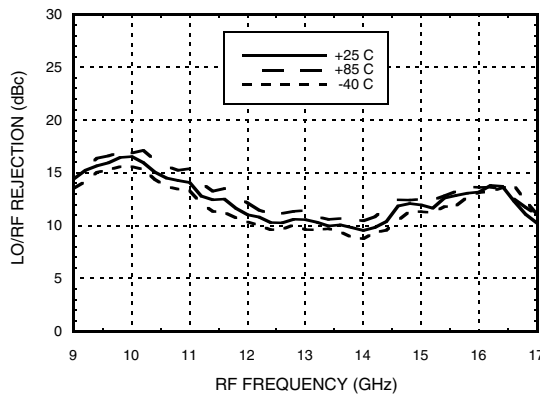

**Input IP3, LSB vs. Control Voltage**

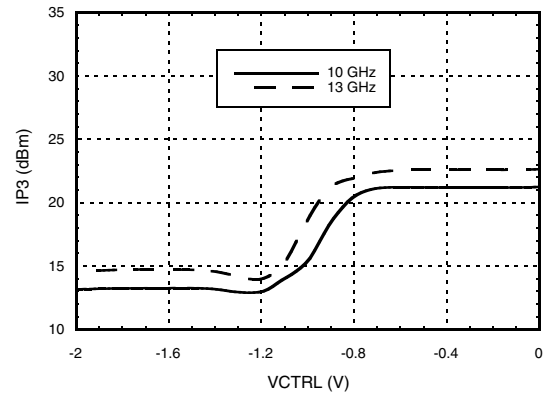



Data Taken as SSB Upconverter with External IF 90° Hybrid, IF = 3000 MHz

Conversion Gain, USB vs. Temperature

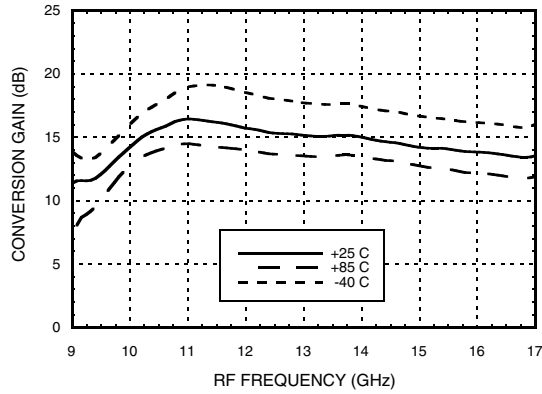

Conversion Gain, USB vs. LO Drive

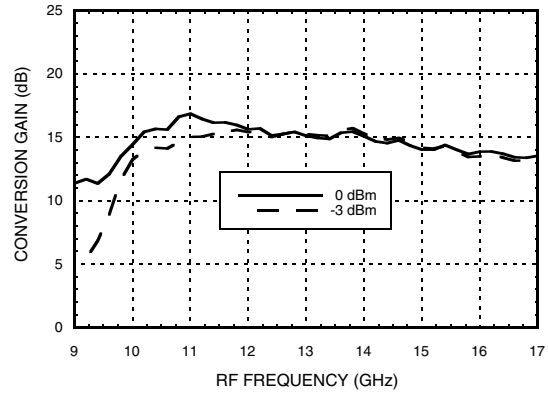

Sideband Rejection, USB vs. Temperature

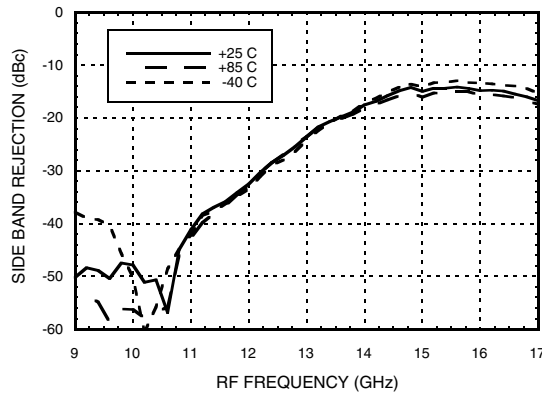

Input P1dB, USB vs. Temperature

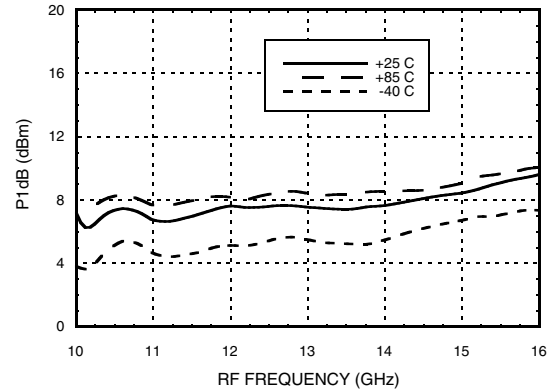

Output P1dB, USB vs. Temperature

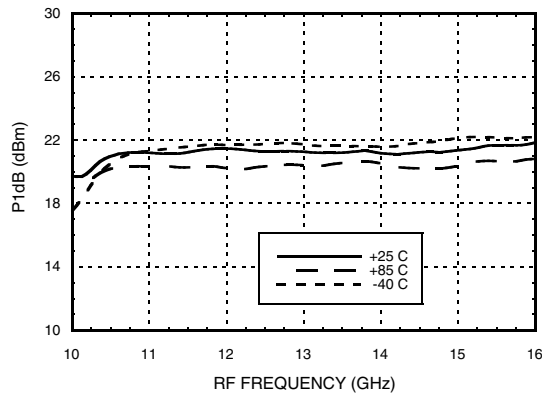

Input IP3, USB vs. Temperature

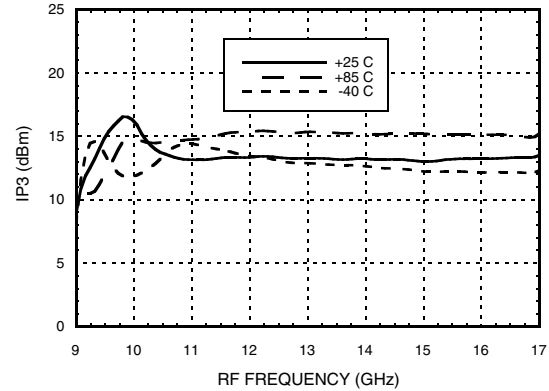

Data Taken as SSB Upconverter with External IF 90° Hybrid, IF = 3000 MHz

Output IP3, USB vs. Temperature

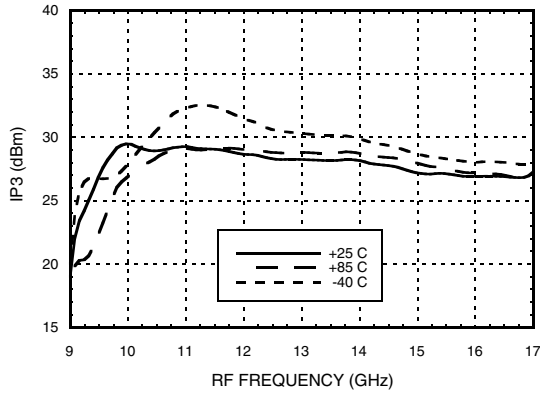

Conversion Gain, USB vs. Control Voltage

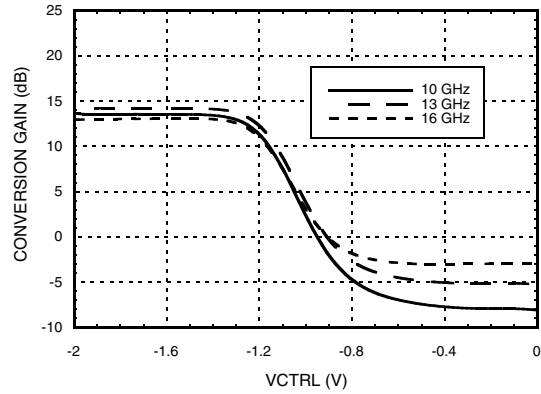

LO/RF Rejection, USB vs. Temperature

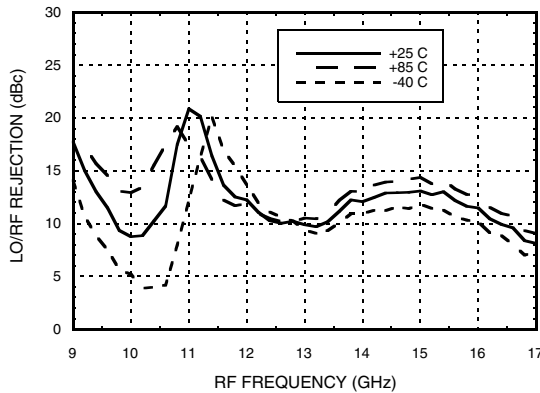

Input IP3, USB vs. Control Voltage

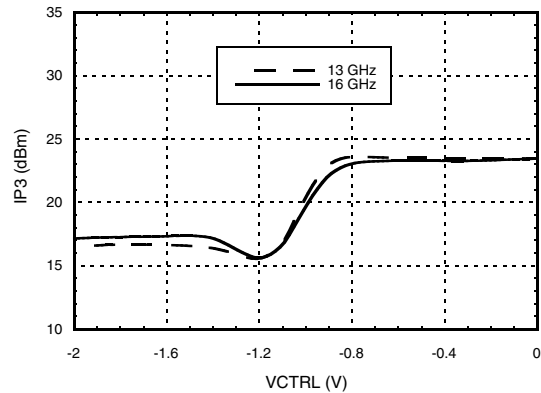





Data Taken as SSB Upconverter with External IF 90° Hybrid, IF = 3000 MHz

Conversion Gain, LSB vs. Temperature

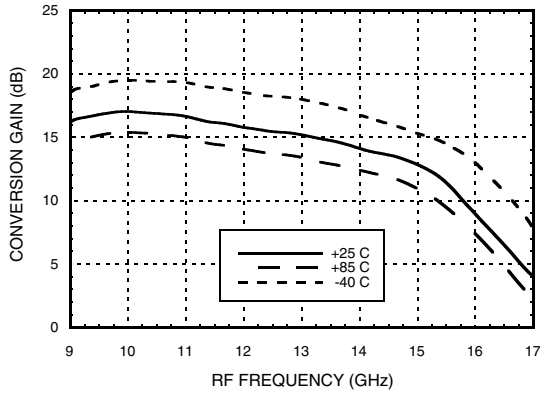

Conversion Gain, LSB vs. LO Drive

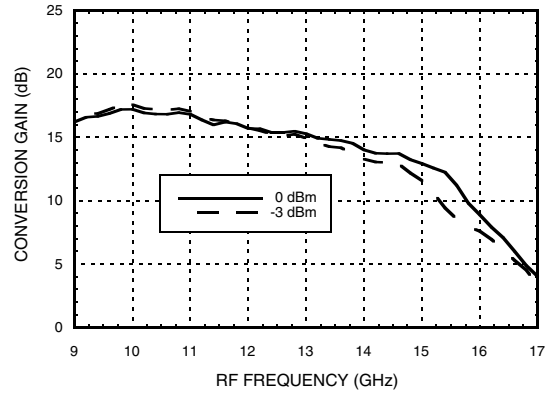

Sideband Rejection, LSB vs. Temperature

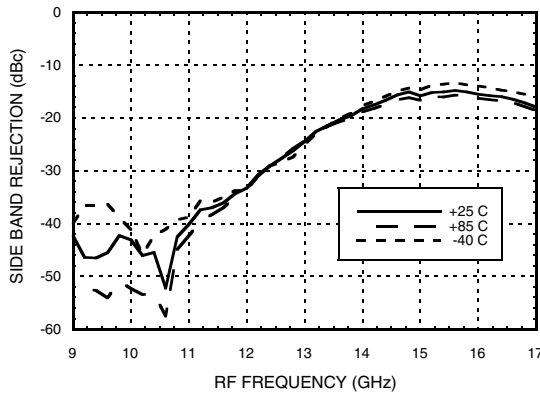

Input P1dB, LSB vs. Temperature

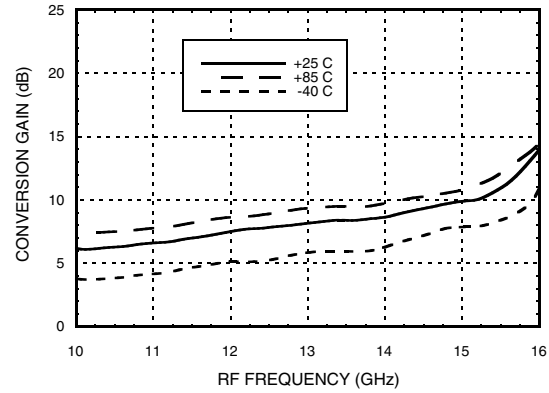

Output P1dB, LSB vs. Temperature

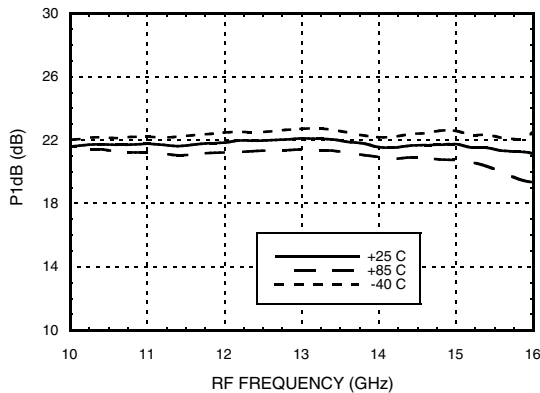

Input IP3, LSB vs. Temperature

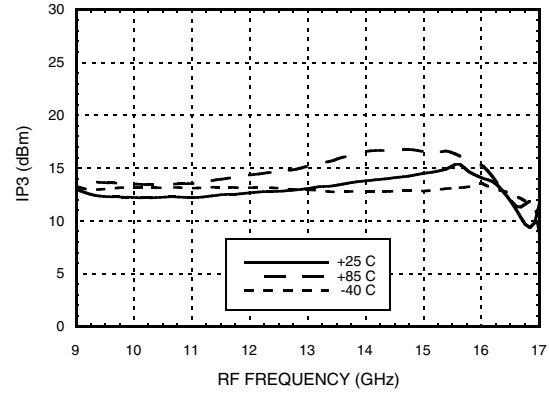

Data Taken as SSB Upconverter with External IF 90° Hybrid, IF = 3000 MHz

Output IP3, LSB vs. Temperature

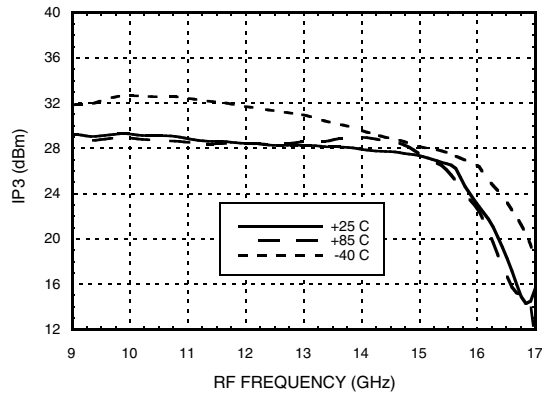

Conversion Gain, LSB vs. Control Voltage

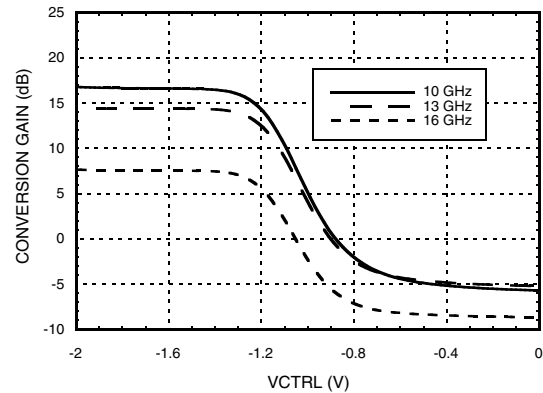

LO/RF Rejection, LSB vs. Temperature

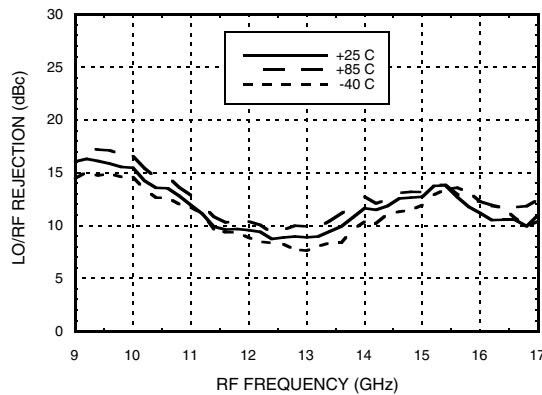

Input IP3, USB vs. Control Voltage

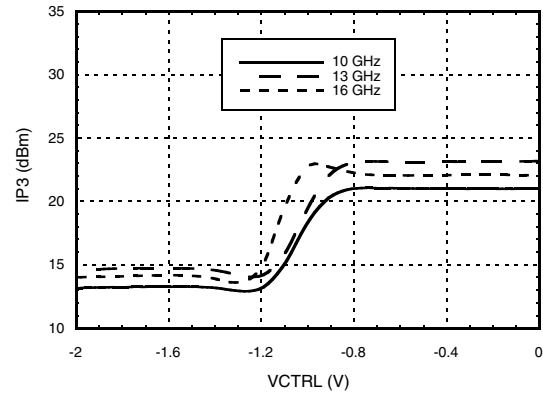

**MxN Spurious Outputs [1][2]**

mIF	nLO				
	0	1	2	3	4
0	x	-6.4	-40.2	xx	xx
1	-54.2	0	-47.2	-73.2	xx
2	-40.2	-47.2	-45.0	-82.2	xx
3	-67.2	-49.2	-74.2	-75.2	xx
4	-69.2	-78.2	-74.2	-85.2	xx

IF = 2.0 GHz @ -10 dBm  
LO = 16.9 GHz @ 0 dBm

**MxN Spurious Outputs [1][2]**

mIF	nLO				
	0	1	2	3	4
0	0	-5.0	-46.3	-63.3	xx
1	-50.3	0	-45.3	-58.3	xx
2	-42.3	-40.3	-46.3	-63.3	xx
3	-64.3	-49.3	-70.2	-68.3	xx
4	-71.3	-76.3	-78.3	-89.3	xx

IF = 2.6 GHz @ -10 dBm  
LO = 15 GHz @ 0 dBm

**MxN Spurious Outputs [1][3]**

mIF	nLO				
	0	1	2	3	4
0	x	-13	-35.1	-68.1	xx
1	-74.1	0	-52.1	-58.1	xx
2	-38.1	-42.1	-46.1	-71.1	xx
3	-87.1	-50.1	-79.1	-75.1	xx
4	-67.1	-94.1	-77.1	xx	xx

IF = 2 GHz @ -10 dBm  
LO = 12.9 GHz @ 0 dBm

**MxN Spurious Outputs [1][3]**

mIF	nLO				
	0	1	2	3	4
0	x	-8.0	-21.8	-54.8	-66.8
-1	-51.8	0	-39.8	-60.8	-87.8
-2	-41.8	-40.8	-46.8	-67.8	-93.8
-3	-66.8	-52.8	-71.8	-69.8	-91.8
-4	-70.8	-77.8	-79.8	-86.8	xx

IF = 2 GHz @ -10 dBm  
LO = 9.1 GHz @ 0 dBm

**Absolute Maximum Ratings**

IF Input	+20 dBm
LO Input	+10 dBm
Channel Temperature	175 °C
Continuous Pdiss (T = 85°C) (derate 18.3 mW/°C above 85°C)	1.65 W
Thermal Resistance (channel to ground paddle)	54.6 °C/W
Storage Temperature	-65 to +150 °C
Operating Temperature	-40 to +85 °C



**ELECTROSTATIC SENSITIVE DEVICE  
OBSERVE HANDLING PRECAUTIONS**

[1] Data taken without external IF 90° hybrid  
[2] All values in dBc below IF power level (LO - IF) LSB  
[3] All values in dBc above IF power level (LO + IF) USB



### Outline Drawing

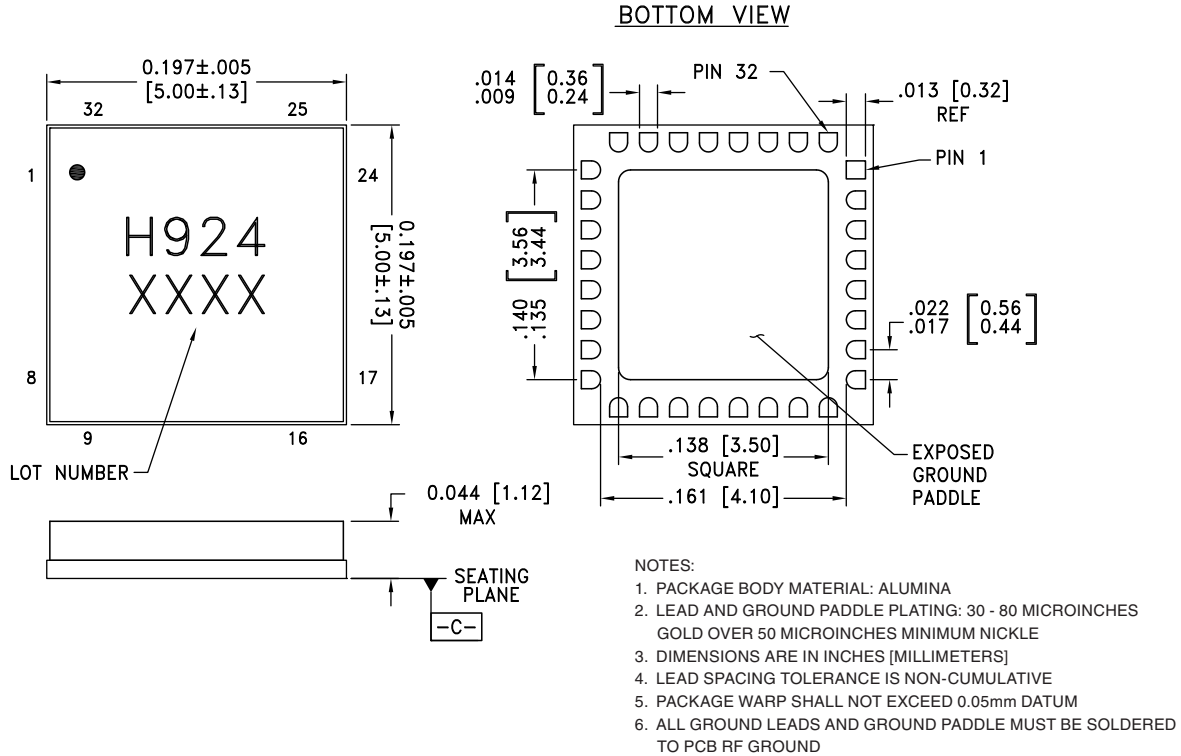

### Pin Descriptions

Pin Number	Function	Description	Interface Schematic
1 - 4, 6, 9 - 11, 16, 17, 19, 20, 22, 24, 25, 29, 32	N/C	No connection required. The pins are not connected internally; however, all data shown herein was measured with these pins connected to RF/DC ground externally.	
5	Vdd1	Power supply voltage for LO amplifier. See application circuit for required external components.	
7	LOIN	This pin is AC coupled and matched to 50 Ohms.	
8, 13, 15, 27, 31	GND	These pins and package bottom must be connected to RF/DC ground.	
12	Vgg	Gate control for RF amplifier, please follow "MMIC Amplifier Biasing Procedure" application note. See application circuit for required external components.	
14	RFOUT	This pin is AC coupled and matched to 50 Ohms.	



### Pin Descriptions

Pin Number	Function	Description	Interface Schematic
18, 21, 23	Vdd4, Vdd3, Vdd2	Power supply voltage for RF amplifier. See application circuit for required external components.	
26	Vctrl	Gain Control Voltage for RF Amplifier	
28	IF1	Differential IF input pins. For applications not requiring operation to DC, an off chip DC blocking capacitor should be used. For operation to DC this pin must not source/sink more than 3mA of current or part non function and possible part failure will result.	
30	IF2		

### Typical Application

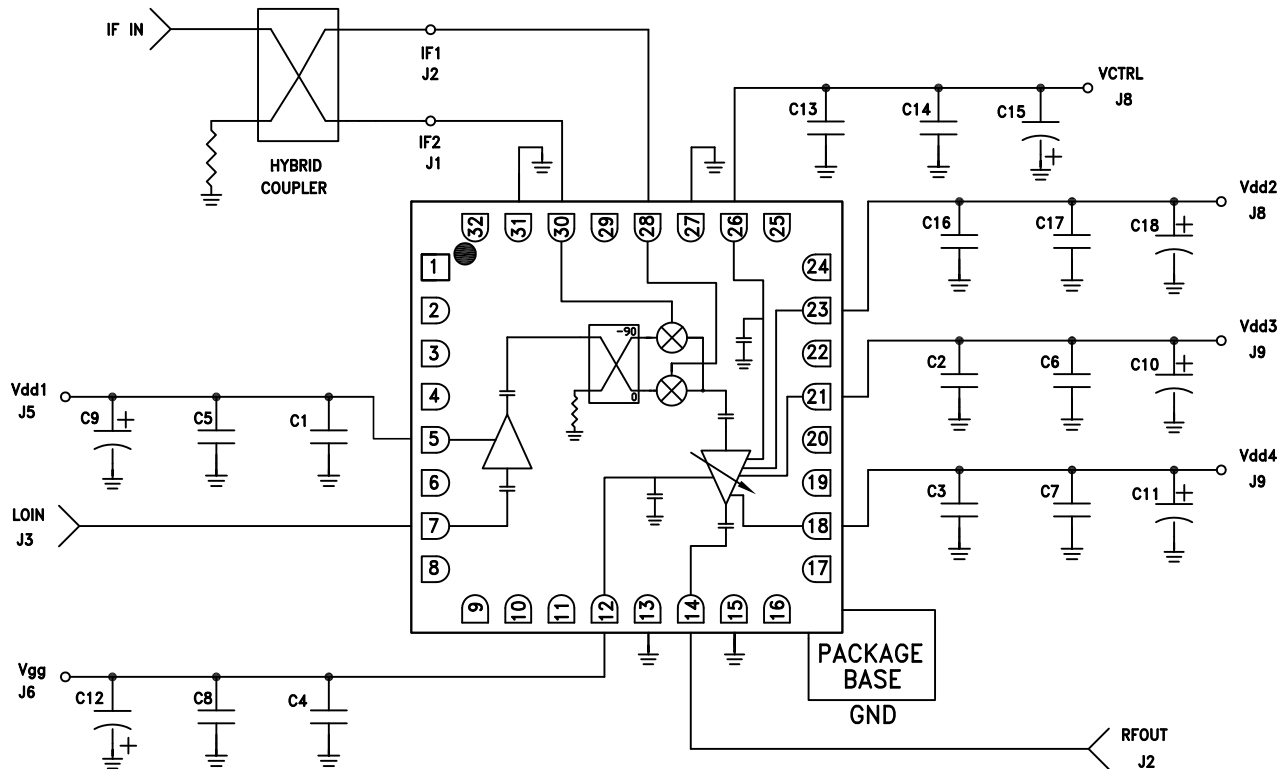

C1-C4, C13, C16	100 pF Capacitor, 0402 Pkg.
C5 - C8, C14, C17	1000 pF Capacitor, 0603 Pkg.
C9 - C12, C15, C18	2.2 μF Capacitor, Case A Pkg.

### Evaluation PCB

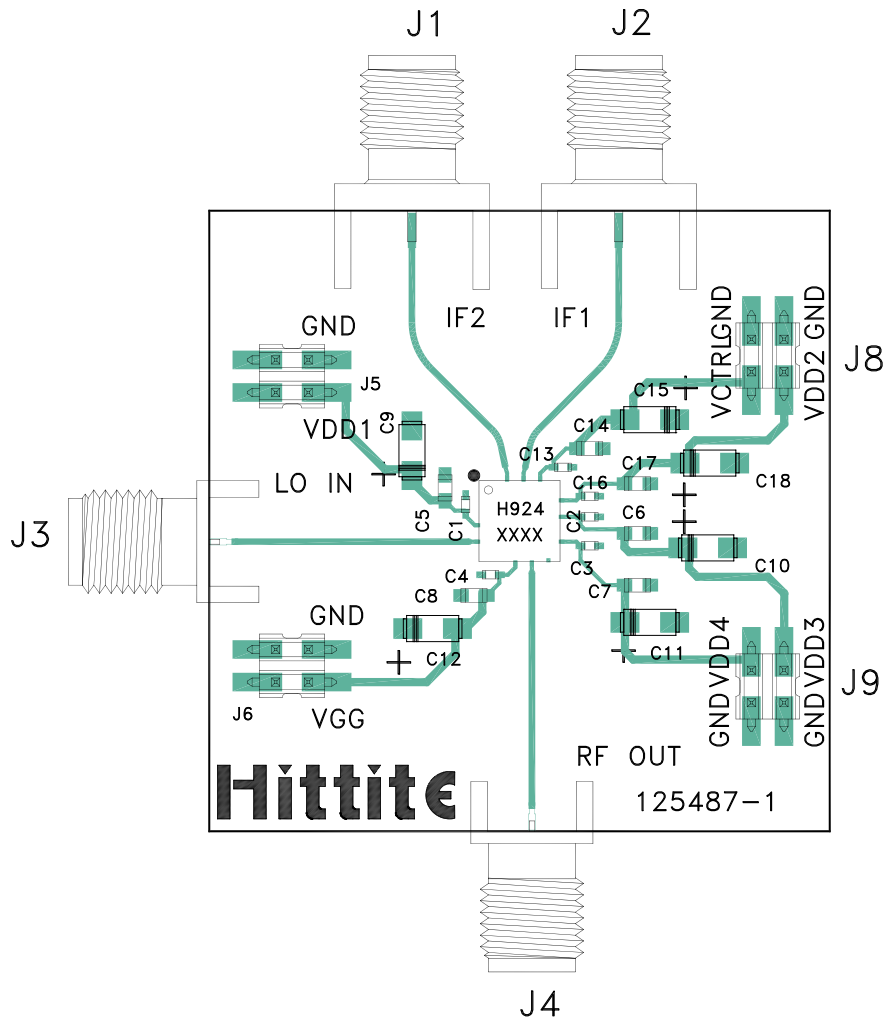

### List of Materials for Evaluation PCB 131092 [1]

Item	Description
J1, J2	SMA Connector
J3, J4	K-Connector SRI
J5, J6, J8, J9	DC Pins
C1 - C4, C13, C16	100 pF Capacitor, 0402 Pkg.
C5 - C8, C14, C17	1000 pF Capacitor, 0603 Pkg.
C9 - C12, C15, C18	2.2 μF Capacitor, Case A
U1	HMC924LC5 Upconverter
PCB [2]	125487 Evaluation Board

[1] Reference this number when ordering complete evaluation PCB

[2] Circuit Board Material: Arlon 25FR, FR4 or Rogers 4350

The circuit board used in the application should use RF circuit design techniques. Signal lines should have 50 Ohm impedance while the package ground leads and exposed paddle should be connected directly to the ground plane similar to that shown. A sufficient number of via holes should be used to connect the top and bottom ground planes. The evaluation circuit board shown is available from Hittite upon request.