

### Typical Applications

The HMC943LP5E is ideal for:

- Point-to-Point Radios
- Point-to-Multi-Point Radios
- VSAT
- Military & Space

### Features

- Saturated Output Power: +34 dBm @ 24% PAE
- High Output IP3: +41 dBm
- High Gain: 21 dB
- DC Supply: +5.5V @ 1200 mA
- No External Matching Required
- 32 Lead 5 x 5 mm SMT Package: 25 mm<sup>2</sup>

### Functional Diagram

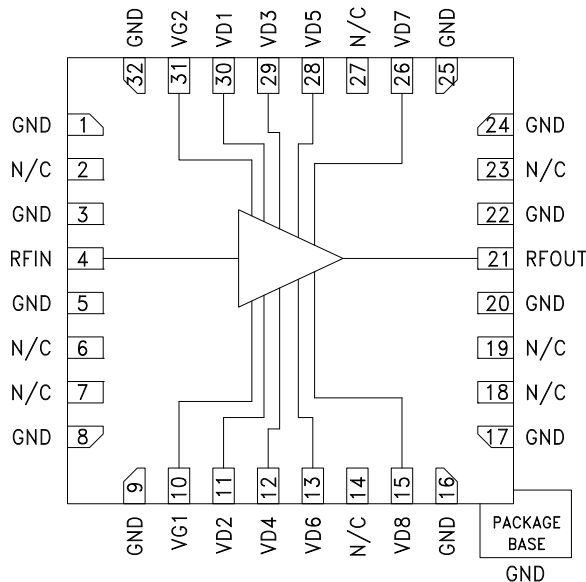

### General Description

The HMC943LP5E is a four stage GaAs pHEMT MMIC 1.5 Watt Power Amplifier which operates between 24 and 31.5 GHz. The HMC943LP5E provides 21 dB of gain, and +34 dBm of saturated output power and 24% PAE from a +5.5V supply. The high output IP3 of +41 dBm makes the HMC943LP5E ideal for microwave radio applications. The HMC943LP5E amplifier I/Os are internally matched to 50 Ohms and is packaged in a leadless QFN 5 x 5 mm surface mount package and requires no external matching components.

### Electrical Specifications, $T_A = +25^\circ\text{C}$ , $V_{d1} = V_{d8} = +5.5\text{V}$ , $I_{dd} = 1200\text{ mA}$ [1]

Parameter	Min.	Typ.	Max.	Min.	Typ.	Max.	Units
Frequency Range	24 - 26.5		26.5 - 31.5				GHz
Gain	18	21		16	19		dB
Gain Variation Over Temperature		0.03			0.028		dB/°C
Input Return Loss		9			9.5		dB
Output Return Loss		12			12		dB
Output Power for 1 dB Compression (P1dB)	29	32		27	31		dBm
Saturated Output Power (P <sub>sat</sub> )		33			33		dBm
Output Third Order Intercept (IP3) <sup>[2]</sup>		41			39		dBm
Total Supply Current (I <sub>dd</sub> )		1200			1200		mA

[1] Adjust Vg1 and Vg2 between -2 to 0V to achieve I<sub>dd</sub> = 1200 mA typical.

[2] Measurement taken at +5.5V @ 1200 mA, P<sub>out</sub> / Tone = +22 dBm

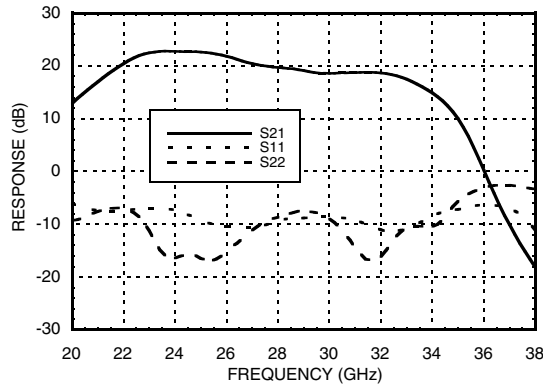
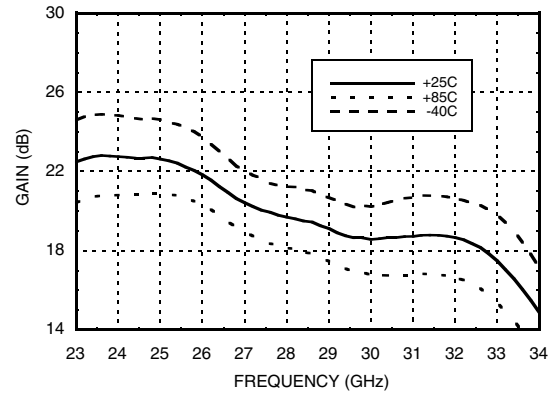
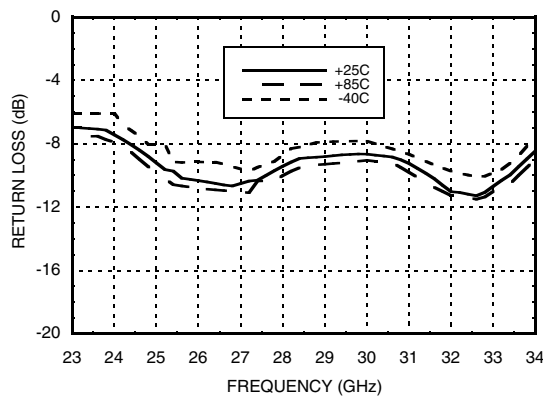
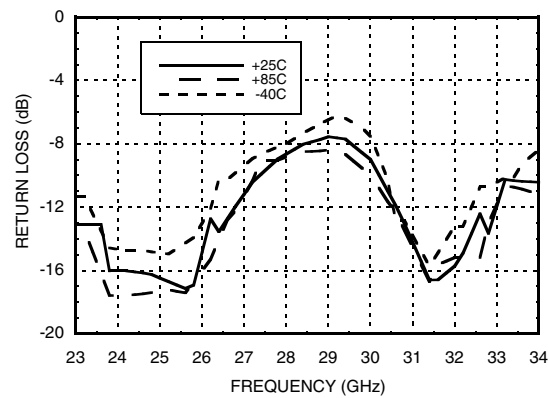
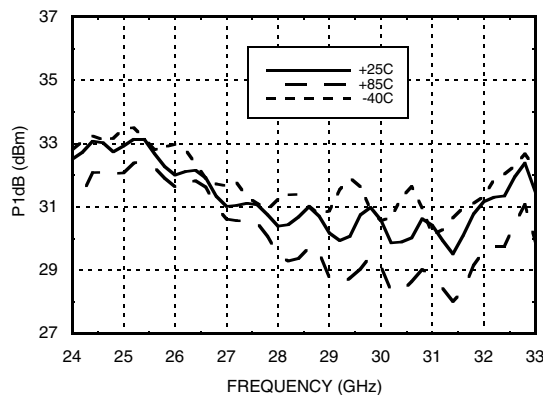
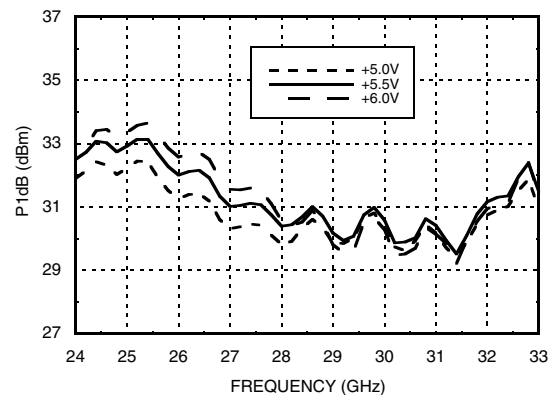

**GaAs pHEMT MMIC 1.5 WATT  
POWER AMPLIFIER, 24 - 31.5 GHz**
**Broadband Gain &  
Return Loss vs. Frequency**

**Gain vs. Temperature**

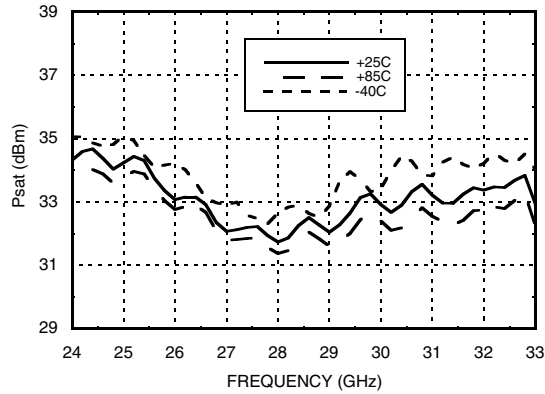
**Input Return Loss vs. Temperature**

**Output Return Loss vs. Temperature**

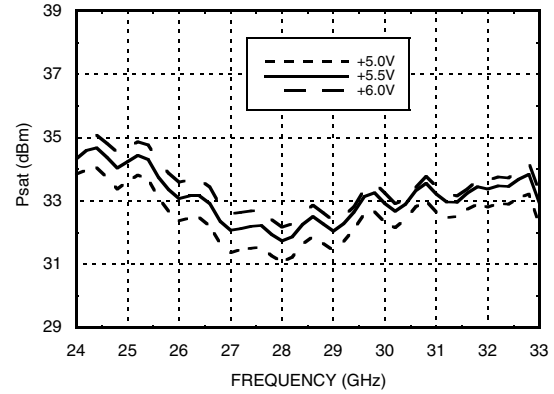
**P1dB vs. Temperature**

**P1dB vs. Supply Voltage**

## GaAs pHEMT MMIC 1.5 WATT POWER AMPLIFIER, 24 - 31.5 GHz

**Psat vs. Temperature**



**Psat vs. Supply Voltage**



**P1dB vs. Supply Current (Idd)**

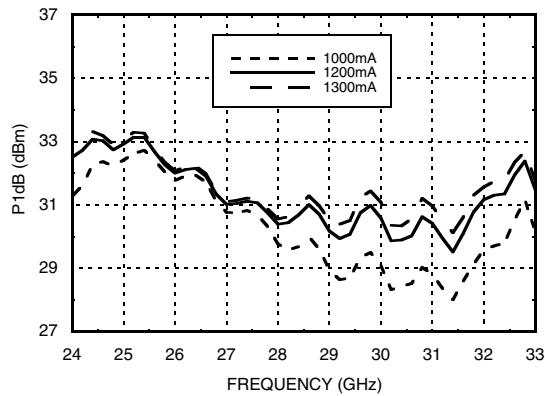

**Psat vs. Supply Current (Idd)**

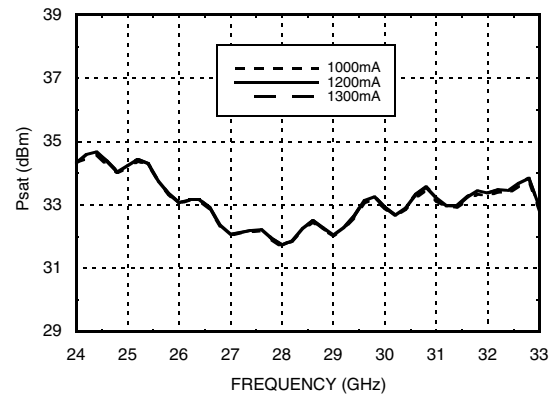

**Output IP3 vs. Temperature, Pout/Tone = +22 dBm**

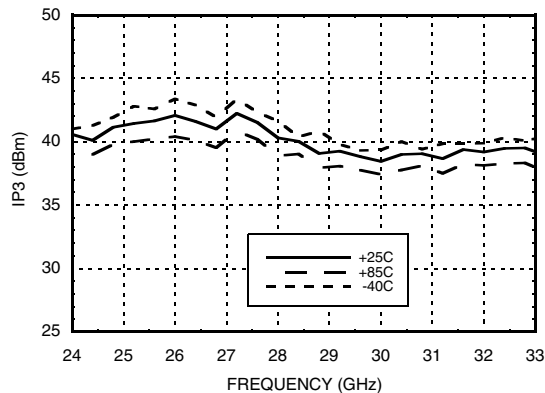

**Output IP3 vs. Supply Current, Pout/Tone = +22 dBm**

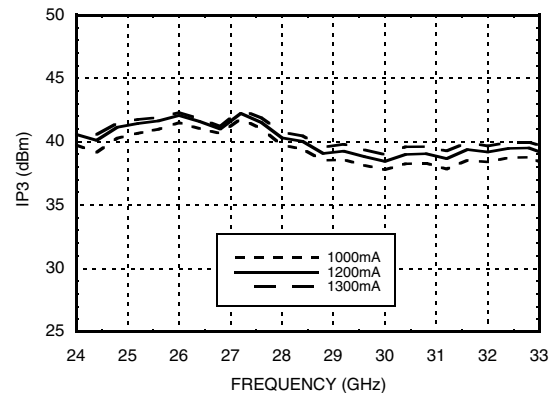



## GaAs pHEMT MMIC 1.5 WATT POWER AMPLIFIER, 24 - 31.5 GHz

**Output IP3 vs. Supply Voltage, Pout/Tone = +22 dBm**

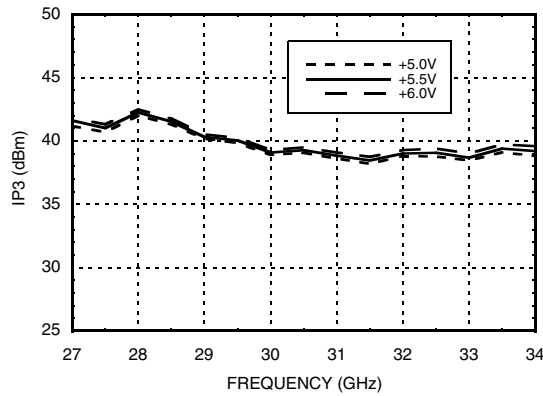

**Output IM3 @ Vdd = +5V**

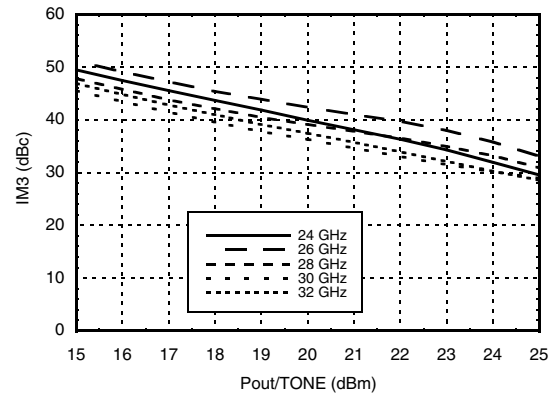

**Output IM3 @ Vdd = +5.5V**

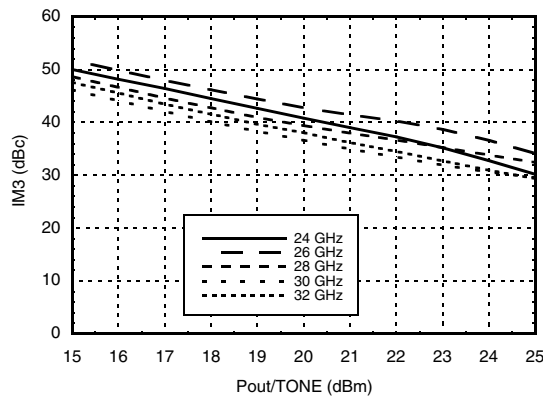

**Output IM3 @ Vdd = +6V**

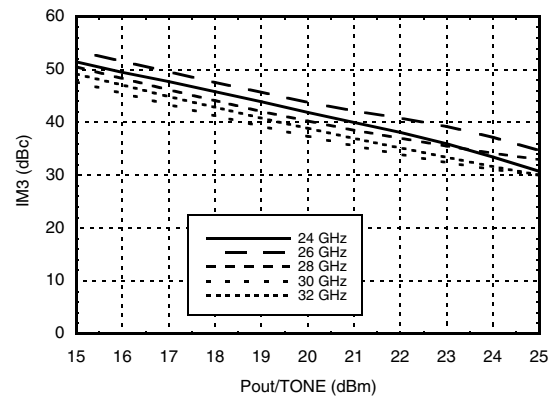

**Power Compression @ 24 GHz**

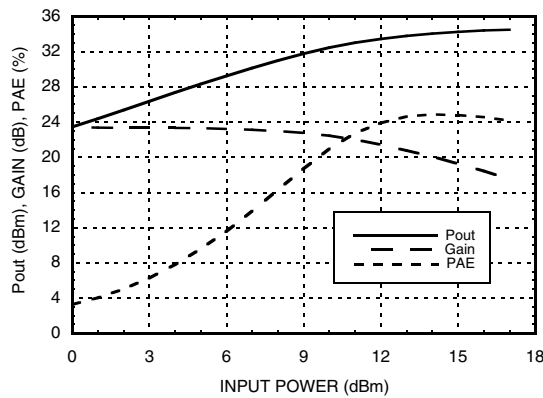

**Power Compression @ 29 GHz**

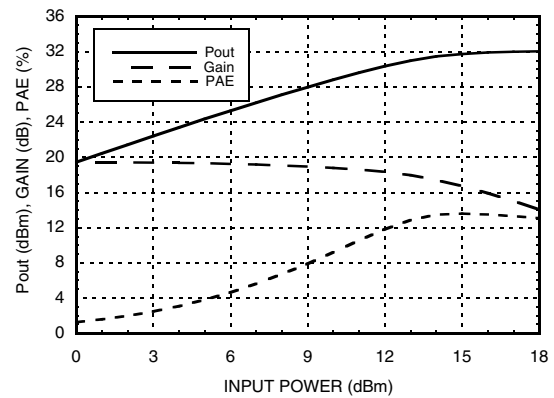



## GaAs pHEMT MMIC 1.5 WATT POWER AMPLIFIER, 24 - 31.5 GHz

### Power Compression @ 32 GHz

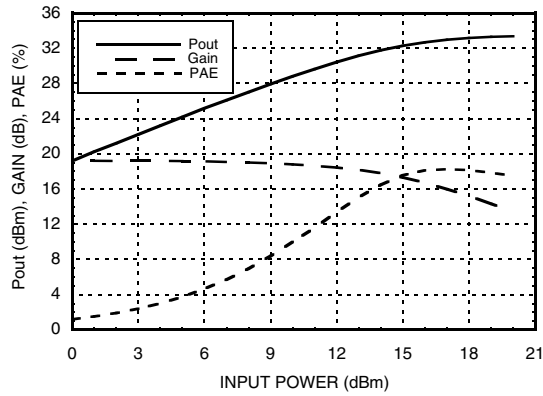

### Reverse Isolation

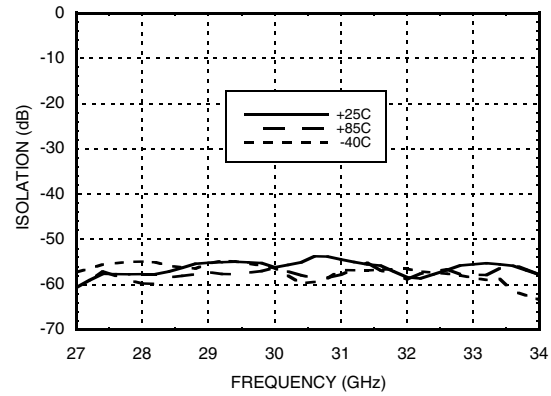

### Gain & Power vs. Supply Current @ 26 GHz

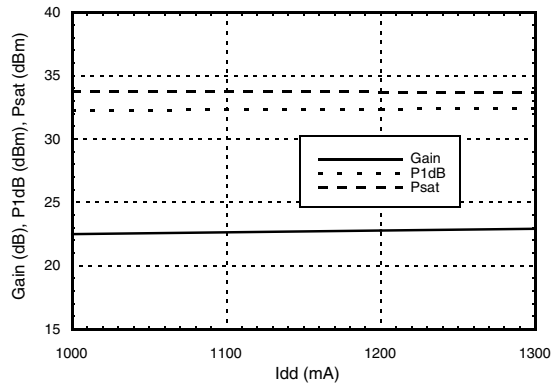

### Gain & Power vs. Supply Voltage @ 26 GHz

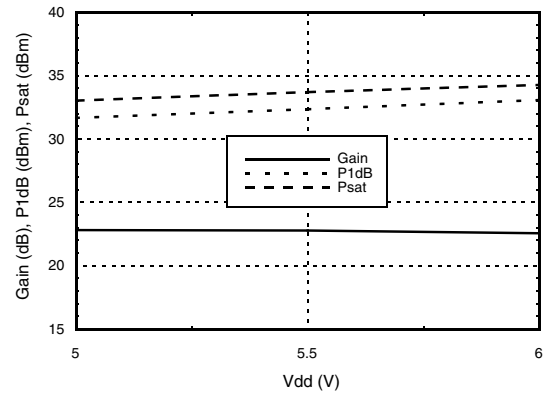

### Power Dissipation @ 6V, 1200 mA

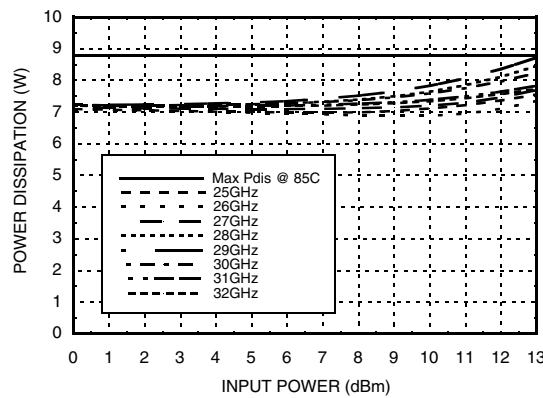



## GaAs pHEMT MMIC 1.5 WATT POWER AMPLIFIER, 24 - 31.5 GHz

### Absolute Maximum Ratings

Drain Bias Voltage (Vd)	+7V
RF Input Power (RFIN)	+20 dBm
Channel Temperature	150 °C
Continuous Pdiss (T= 85 °C) (derate 135 mW/°C above 85 °C)	8.8 W
Thermal Resistance (channel to package bottom)	7.4 °C/W
Storage Temperature	-65 to +150 °C
Operating Temperature	-55 to +85 °C
ESD Sensitivity (HBM)	Class 0, 150V

### Typical Supply Current vs. Vdd

Vdd (V)	Idd (mA)
+5.0	1200
+5.5	1200
+6.0	1200

Note: Amplifier will operate over full voltage ranges shown above Vgg adjusted to achieve Idd = 1200 mA



ELECTROSTATIC SENSITIVE DEVICE  
OBSERVE HANDLING PRECAUTIONS

### Outline Drawing

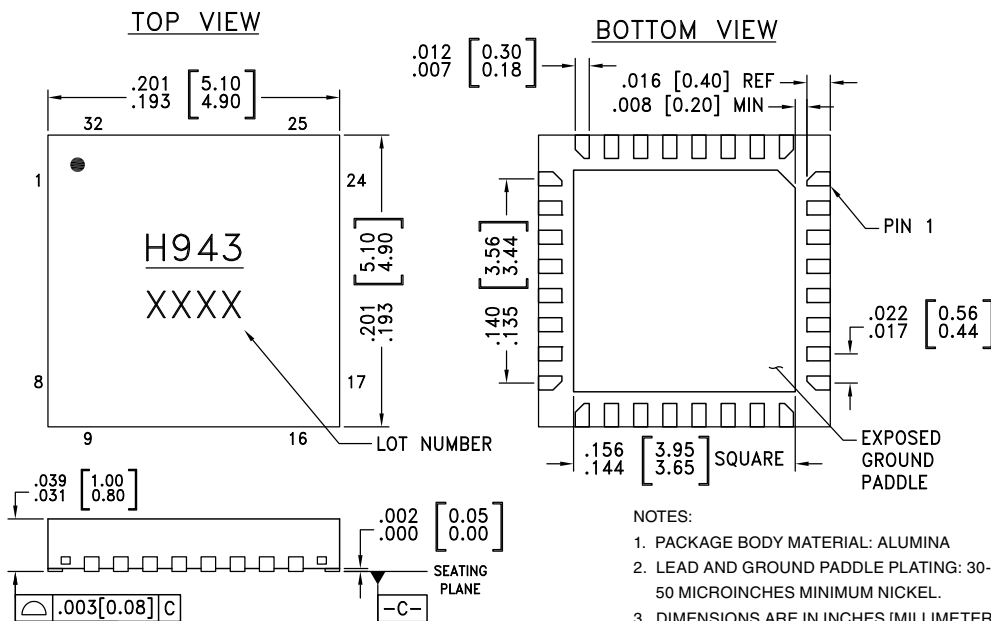

- NOTES:
1. PACKAGE BODY MATERIAL: ALUMINA
  2. LEAD AND GROUND PADDLE PLATING: 30-80 MICROINCHES GOLD OVER 50 MICROINCHES MINIMUM NICKEL.
  3. DIMENSIONS ARE IN INCHES [MILLIMETERS].
  4. LEAD SPACING TOLERANCE IS NON-CUMULATIVE
  5. PACKAGE WARP SHALL NOT EXCEED 0.05 mm DATUM [-C-]
  6. ALL GROUND LEADS AND GROUND PADDLE MUST BE SOLDERED TO PCB RF GROUND.
  7. CLASSIFIED AS MOISTURE SENSITIVITY LEVEL (MSL) 1.



### Package Information

Part Number	Package Body Material	Lead Finish	MSL Rating	Package Marking <sup>[1]</sup>
HMC943LP5E	RoHS-compliant Low Stress Injection Molded Plastic	100% matte Sn	MSL1 <sup>[2]</sup>	H943 XXXX

[1] 4-Digit lot number XXXX

[2] Max peak reflow temperature of 260 °C

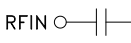
**Pin Descriptions**

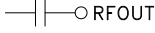
Pin Number	Function	Description	Interface Schematic
1, 3, 5, 8, 9, 16, 17, 20, 22, 24, 25, 32	GND	These pins and package bottom must be connected to RF/DC ground.	
2, 6, 7, 14, 18, 19, 23, 27	N/C	These pins are not connected internally; however, all data shown herein was measured with these pins connected to RF/DC ground externally.	
4	RFIN	RF signal input. This pad is AC coupled and matched to 50 Ohms over the operating frequency range.	
10, 31	VG1, VG2	Gate control for amplifier. External bypass capacitors of 100 pF, 0.01 μF, and 4.7 μF are required on each.	
11 - 13, 15, 26, 28 - 30	VD2, VD4, VD6, VD8, VD7, VD5, VD3, VD1	Drain bias for the amplifier. External bypass capacitors of 100 pF, 0.01 μF, and 4.7 μF are required on each.	
21	RFOUT	RF signal output. This pad is AC coupled and matched to 50 ohms over the operating frequency range.	

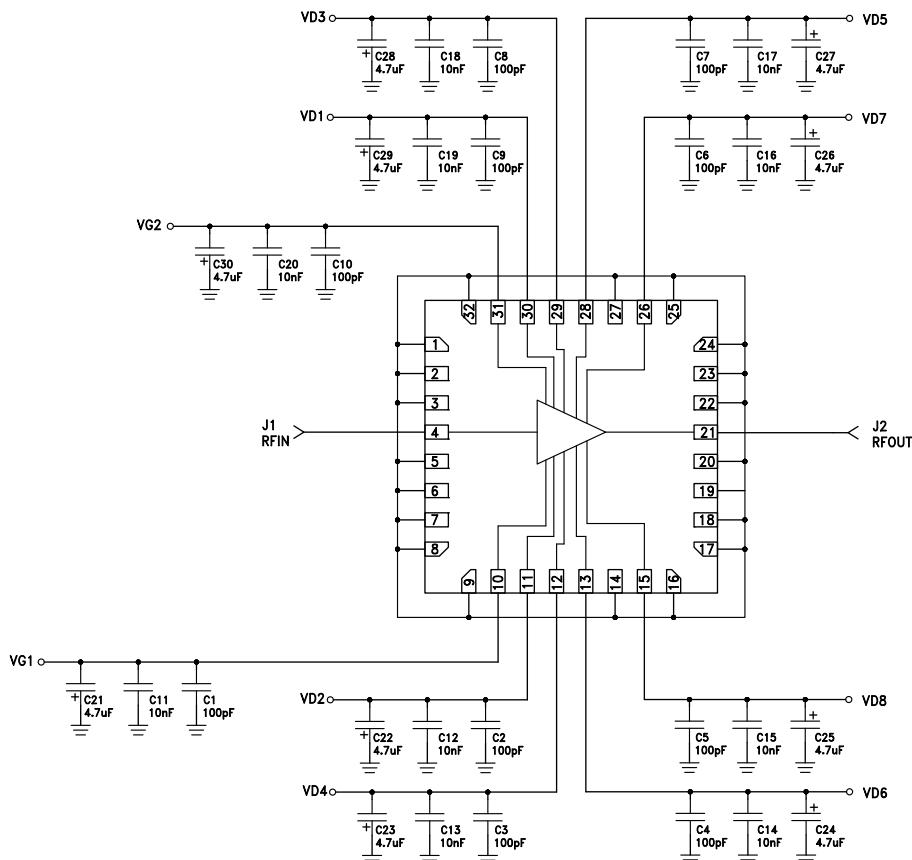
**Application Circuit**

For price, delivery and to place orders: Hittite Microwave Corporation, 2 Elizabeth Drive, Chelmsford, MA 01824

 Phone: 978-250-3343 Fax: 978-250-3373 Order On-line at [www.hittite.com](http://www.hittite.com)

 Application Support: Phone: 978-250-3343 or [apps@hittite.com](mailto:apps@hittite.com)

### Evaluation PCB

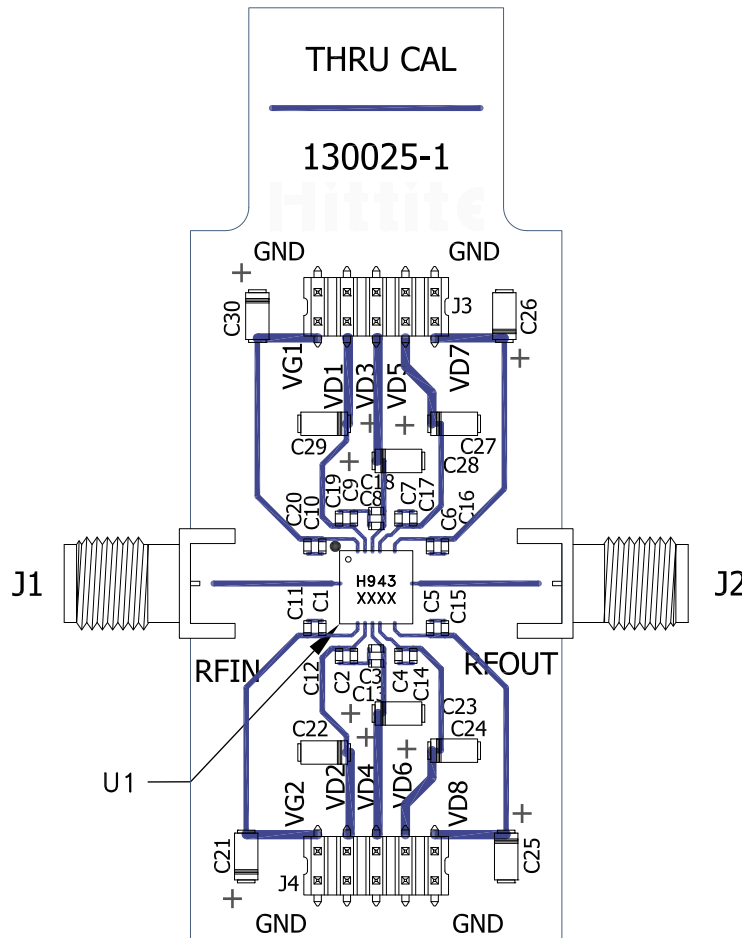

### List of Materials for Evaluation PCB 130027 [1]

Item	Description
J1, J2	SRI, K Connectors
J3, J4	DC Pins
C1 - C10	100 pF Capacitors, 0402 Pkg.
C11 - C20	10000 pF Capacitors, 0402 Pkg.
C21 - C30	4.7 μF Capacitors, Case A Pkg.
U1	HMC943LP5E Power Amplifier
PCB [2]	130025 Evaluation PCB

[1] Reference this number when ordering complete evaluation PCB

[2] Circuit Board Material: Rogers 4350 or Arlon FR4

The circuit board used in the application should use RF circuit design techniques. Signal lines should have 50 Ohm impedance while the package ground leads and exposed paddle should be connected directly to the ground plane similar to that shown. A sufficient number of via holes should be used to connect the top and bottom ground planes. The evaluation board should be mounted to an appropriate heat sink. The evaluation circuit board shown is available from Hittite upon request.