

Features

- High Linear Gain: 30 dB Typical
- High Saturated Output Power: +33 dBm Typ.
- High Power Added Efficiency: 26% Typ.
- 50 Ω Input/Output Broadband Matched
- Lead-Free Ceramic Bolt Down Package
- RoHS* Compliant and 260°C Reflow Compatible

Description

The AM42-0040 is a three-stage MMIC power amplifier in a lead-free, ceramic bolt down style hermetic package. The AM42-0040 employs an internally matched monolithic chip with internally decoupled Gate and Drain bias networks. The AM42-0040 is designed to be operated from a constant current Drain supply. By varying the Gate bias voltage, the saturated output power performance of this device can be tailored for various applications.

The AM42-0040 is designed for use as an output stage or driver amplifier for C-band VSAT transmitter systems. This amplifier employs a fully monolithic chip and requires a minimum of external components.

The AM42-0040 is fabricated using a mature 0.5 micron GaAs MESFET process. The process features full passivation for increased performance and reliability. This product is 100% RF tested to ensure compliance to performance specifications.

Ordering Information

Part Number	Package
AM42-0040	Ceramic Bolt Down

Functional Schematic

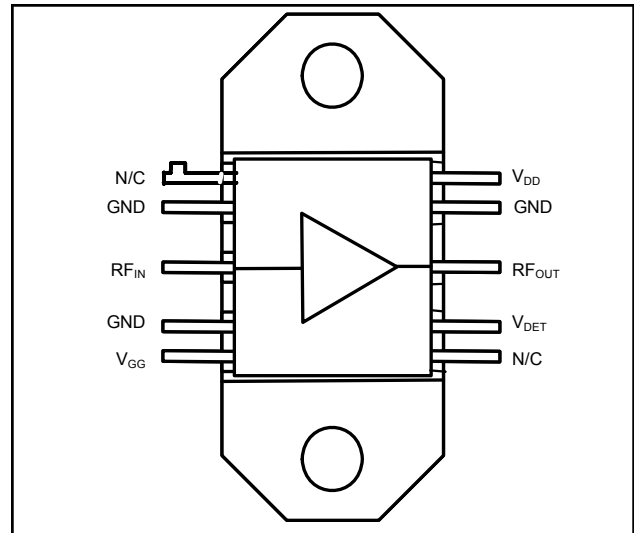

Pin Configuration

Pin No.	Pin Name	Description
1	N/C	No Connection
2	GND	DC and RF Ground
3	RF In	RF Input
4	GND	DC and RF Ground
5	V _{GG}	Gate Supply
6	N/C	No Connection
7	V _{DET}	Detector
8	RF Out	RF Output
9	GND	DC and RF Ground
10	V _{DD}	Drain Supply

* Restrictions on Hazardous Substances, European Union Directive 2002/95/EC.

Electrical Specifications: $T_A = 25^\circ\text{C}$, $V_{DD} = +9\text{ V}$, V_{GG} adjusted for $I_{DD} = 1050\text{ mA}$

Parameter	Test Conditions	Units	Min.	Typ.	Max.
Linear Gain	$P_{IN} \leq -10\text{ dBm}$	dB	27	30	—
Input VSWR	$P_{IN} \leq -10\text{ dBm}$	Ratio	—	2.3:1	2.7:1
Output VSWR	$P_{IN} \leq -10\text{ dBm}$	Ratio	—	3.0:1	—
Output Power	$P_{IN} = +10\text{ dBm}$, $I_{DD} = 1050\text{ mA Typ.}$	dBm	31.7	33.0	34.5
Output Power vs. Frequency	$P_{IN} = +10\text{ dBm}$, $I_{DD} = 1050\text{ mA Typ.}$	dB	—	1.0	1.5
Output Power vs. Temperature (with respect to $T_A = 25^\circ\text{C}$)	$P_{IN} = +10\text{ dBm}$, $I_{DD} = 1050\text{ mA Typ.}$ $T_A = -40^\circ\text{C to } +70^\circ\text{C}$	dB	—	± 0.4	—
Drain Bias Current	$P_{IN} = +10\text{ dBm}$	mA	900	1050	1100
Gate Bias Voltage	$P_{IN} = +10\text{ dBm}$, $I_{DD} = 1050\text{ mA Typ.}$	V	-2.4	-1.2	-0.4
Gate Bias Current	$P_{IN} = +10\text{ dBm}$, $I_{DD} = 1050\text{ mA Typ.}$	mA	—	5	20
Thermal Resistance	$25^\circ\text{C Heat Sink}$	$^\circ\text{C/W}$	—	5.6	—
Second Harmonic	$P_{IN} = +10\text{ dBm}$, $I_{DD} = 1050\text{ mA Typ.}$	dBc	—	-35	—
Third Harmonic	$P_{IN} = +10\text{ dBm}$, $I_{DD} = 1050\text{ mA Typ.}$	dBc	—	-45	—
V_{DET}		V	2	—	—

Absolute Maximum Ratings ^{1,2,3}

Parameter	Absolute Maximum
Input Power	+23 dBm
V_{DD}	+12 Volts
V_{GG}	-3 Volts
$V_{DD} - V_{GG}$	+12 Volts
I_{DD}	1700 mA
Channel Temperature	$-40^\circ\text{C to } +85^\circ\text{C}$
Storage Temperature	$-65^\circ\text{C to } +150^\circ\text{C}$

- Exceeding any one or combination of these limits may cause permanent damage to this device.
- M/A-COM Technology does not recommend sustained operation near these survivability limits.
- Case Temperature (TC) = $+25^\circ\text{C}$.

Typical Bias Configuration ^{4,5,6,7,8}

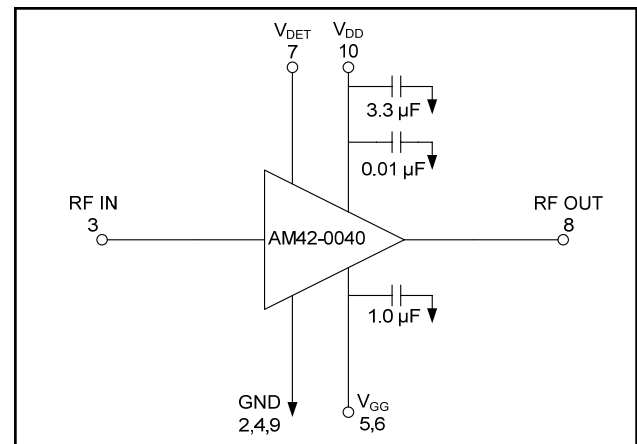

- Nominal bias is obtained by first connecting -2.4 volts to pin 5 (VGG), followed by connection +9 volts to pin 10 (VDD). Note sequence. Adjust VGG for a drain current of 1050 mA typical.
- RF ground and thermal interface is the flange (case bottom). Adequate heat sinking is required.
- No DC bias voltage appears at the RF ports.
- For optimum IP3 performance, the VDD bypass capacitors should be placed within 0.5 inches of the VDD leads.
- Resistor and capacitors surrounding the amplifier are suggestions and not included as part of the AM42-0040.

Typical Performance Curves @ +25°C

Linear Gain vs. Frequency

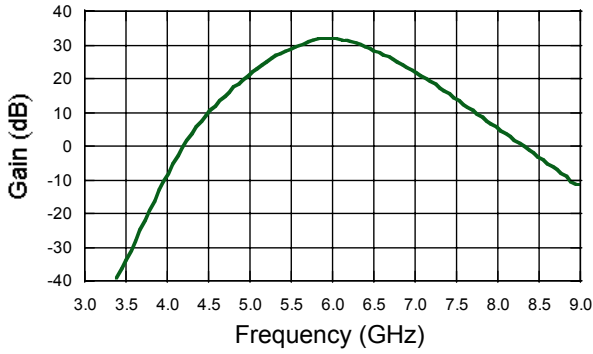

Input and Output Return Loss vs. Frequency

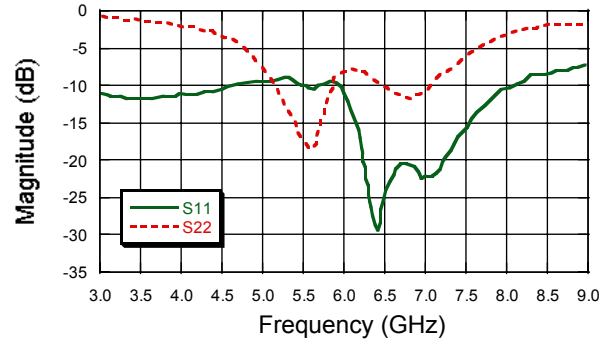

Output Power vs. Frequency @ $P_{IN} = +10$ dBm

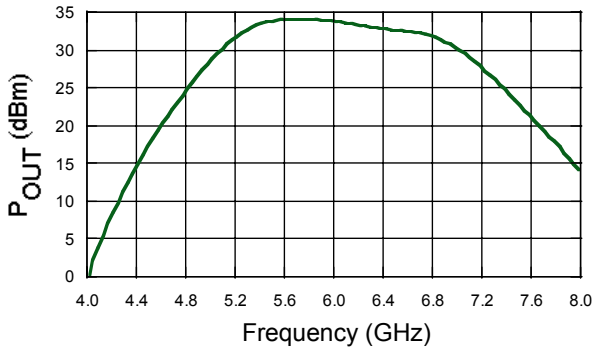

PAE vs. Frequency @ $P_{IN} = +10$ dBm

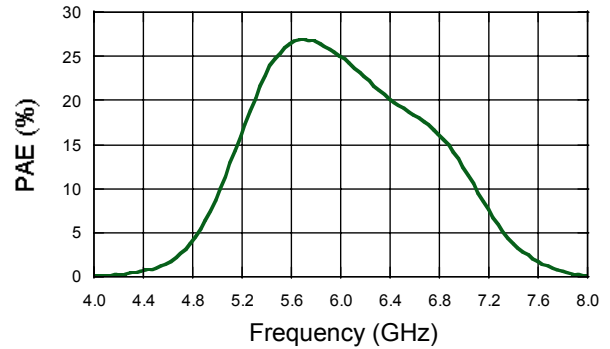

Output Power vs. Input Power @ 6.15 GHz

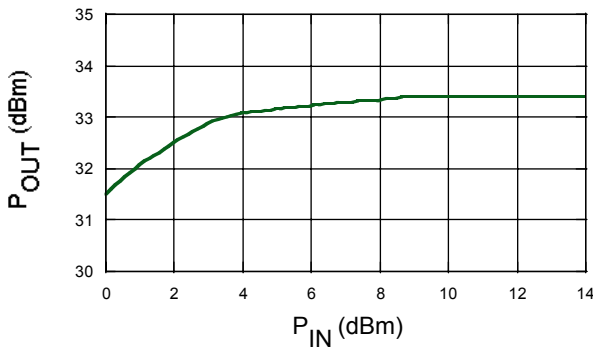

PAE vs. Input Power @ 6.15 GHz

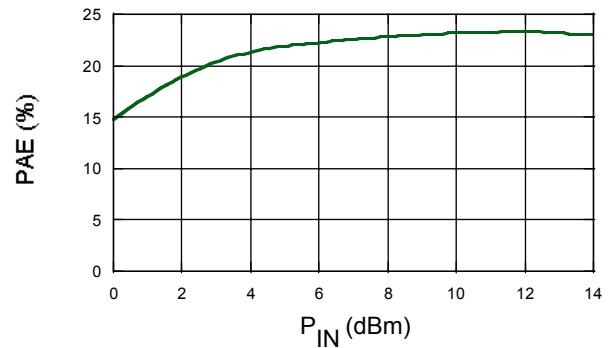

Lead-Free CR-15[†]

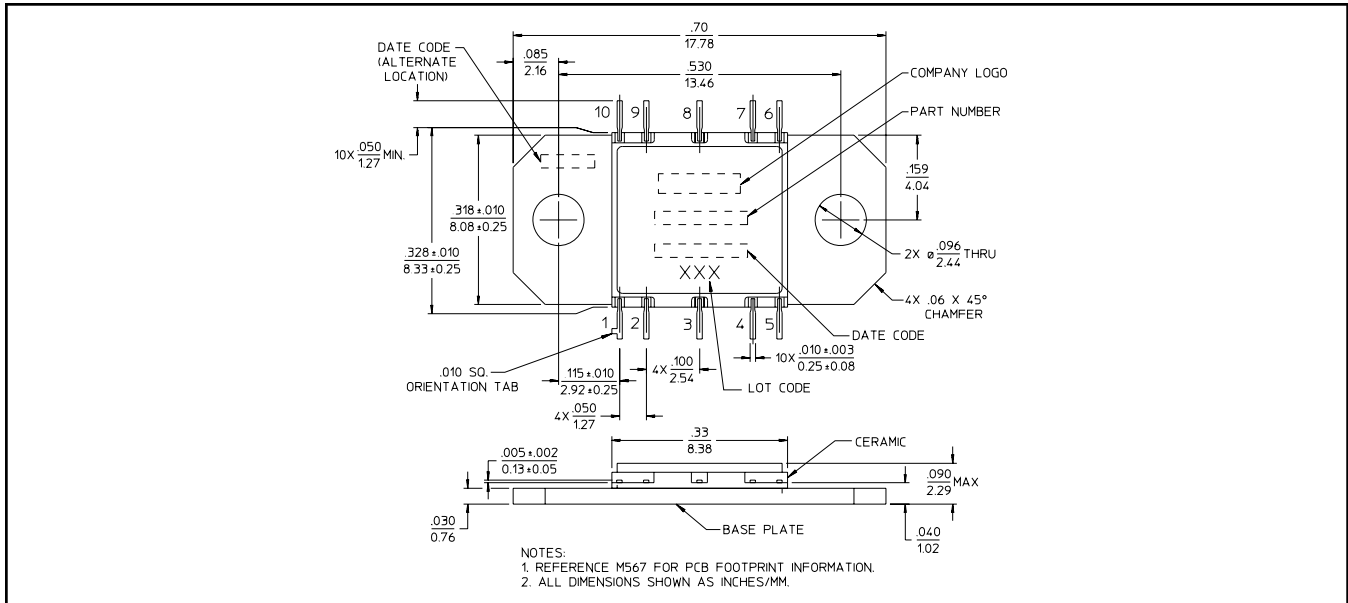

[†] Reference Application Note M538 for lead-free solder reflow recommendations.
Meets JEDEC moisture sensitivity level 1 requirements.

Handling Procedures

Please observe the following precautions to avoid damage:

Static Sensitivity

Gallium Arsenide Integrated Circuits are sensitive to electrostatic discharge (ESD) and can be damaged by static electricity. Proper ESD control techniques should be used when handling these devices.