

## Voltage Variable Absorptive Attenuator 40 dB, 0.5 - 3.0 GHz

Rev. V7

### Features

- Single Positive Voltage Control: 0 to +5 Volts
- 40 dB Attenuation Range at 900 MHz
- $\pm 2$  dB Linearity from BSL
- Low DC Power Consumption
- SOIC-8 Plastic Package
- Tape and Reel Packaging Available

### Description

M/A-COM's AT-108 is a GaAs MESFET MMIC voltage variable absorptive attenuator in a low cost SOIC-8 surface mount plastic package. The AT-108 is ideally suited for use where linear attenuation, fine tuning and very low power consumption are required.

Typical applications include radio, cellular, GPS equipment and automatic gain/level control circuits.

The AT-108 is fabricated with a monolithic GaAs MMIC using a mature 1-micron process. The process features full chip passivation for increased performance and reliability.

### Functional Schematic <sup>3,4,5,6</sup>

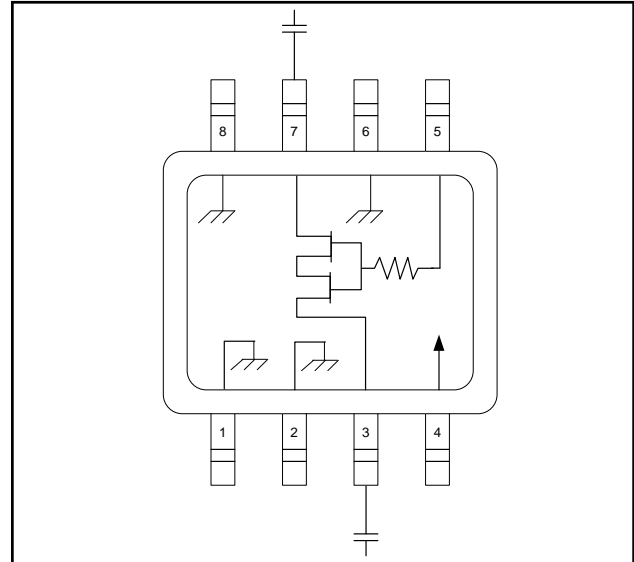

3.  $V_{cc} = +5$  VDC @ 50  $\mu$ A maximum.
4.  $V_c = 0$  VDC to +5 VDC @ 50  $\mu$ A maximum.
5. External DC blocking capacitors are requirements on all RF ports.
6. 39 pF used for data measurements.

### Ordering Information <sup>1,2</sup>

Part Number	Package
AT-108	Bulk Packaging
AT-108TR	1000 piece reel
AT-108SMB	Sample Board

1. Reference Application Note M513 for reel size information.
2. All sample boards include 5 loose parts.

### Pin Configuration

Pin No.	Function	Pin No.	Function
1	Ground	5	$V_c$
2	Ground	6	Ground
3	RF Port	7	RF Port
4	$V_{cc}$	8	Ground

### Absolute Maximum Ratings <sup>7,8</sup>

Parameter	Absolute Maximum
Input Power	+21 dBm
Supply Voltage $V_{cc}$	$-1 \text{ V} \leq V_{cc} \leq +8 \text{ V}$
Control Voltage $V_c$	$-1 \text{ V} \leq V_c \leq V_{cc} + 0.5 \text{ V}$
Operating Temperature	$-40^\circ\text{C}$ to $+85^\circ\text{C}$
Storage Temperature	$-65^\circ\text{C}$ to $+150^\circ\text{C}$

7. Exceeding any one or combination of these limits may cause permanent damage to this device.
8. M/A-COM does not recommend sustained operation near these survivability limits.

## Voltage Variable Absorptive Attenuator 40 dB, 0.5 - 3.0 GHz

Rev. V7

### Electrical Specifications: $T_A = 25^\circ\text{C}$ , $Z_0 = 50 \Omega$

Parameter	Test Conditions	Units	Min.	Typ.	Max.
Insertion Loss	0.5 - 1.0 GHz	dB	—	2.5	2.7
	1.0 - 3.0 GHz	dB	—	3.2	3.5
Attenuation	0.5 - 1.0 GHz	dB	40	—	—
	1.0 - 2.0 GHz	dB	35	—	—
	2.0 - 3.0 GHz	dB	28	—	—
Flatness (peak-to-peak)	0.5 - 1.0 GHz	dB	—	$\pm 0.5$	$\pm 0.8$
	1.0 - 2.0 GHz	dB	—	$\pm 1.2$	$\pm 1.5$
	2.0 - 3.0 GHz	dB	—	$\pm 1.5$	$\pm 1.8$
VSWR	0.5 - 3.0 GHz	Ratio	—	2:1	—
Trise, Tfall	10% to 90% RF, 90% to 10% RF	$\mu\text{S}$	—	15	—
Ton, Toff	50% Control to 90% RF, 50% Control to 10% RF	$\mu\text{S}$	—	25	—
Transients	In-Band	mV	—	12	—

### SOIC-8<sup>†</sup>

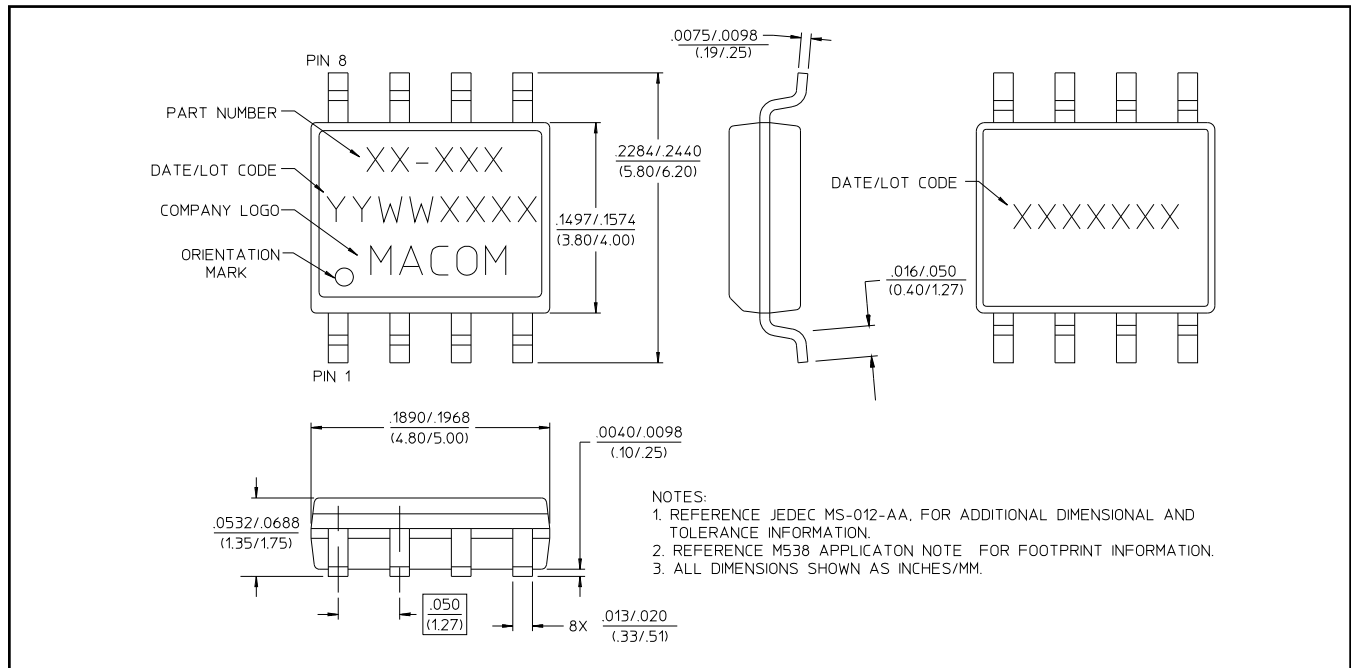

<sup>†</sup> Meets JEDEC moisture sensitivity level 1 requirements.

**ADVANCED:** Data Sheets contain information regarding a product M/A-COM Technology Solutions is considering for development. Performance is based on target specifications, simulated results, and/or prototype measurements. Commitment to develop is not guaranteed.  
**PRELIMINARY:** Data Sheets contain information regarding a product M/A-COM Technology Solutions has under development. Performance is based on engineering tests. Specifications are typical. Mechanical outline has been fixed. Engineering samples and/or test data may be available. Commitment to produce in volume is not guaranteed.

• **North America** Tel: 800.366.2266 / Fax: 978.366.2266  
 • **Europe** Tel: 44.1908.574.200 / Fax: 44.1908.574.300  
 • **Asia/Pacific** Tel: 81.44.844.8296 / Fax: 81.44.844.8298  
 Visit [www.macomtech.com](http://www.macomtech.com) for additional data sheets and product information.

M/A-COM Technology Solutions Inc. and its affiliates reserve the right to make changes to the product(s) or information contained herein without notice.

## Voltage Variable Absorptive Attenuator 40 dB, 0.5 - 3.0 GHz

Rev. V7

### Typical Performance Curves @ 25°C

**Attenuation vs. Control Voltage**

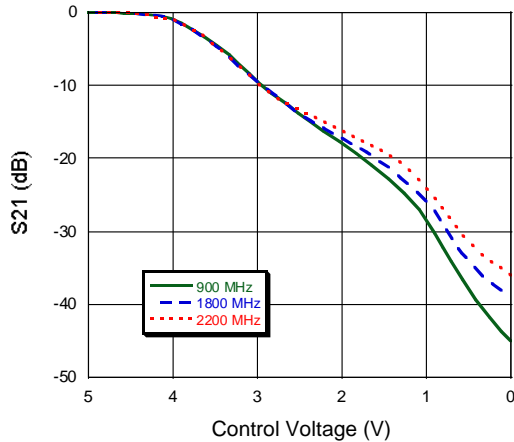

**Insertion Loss vs. Frequency**

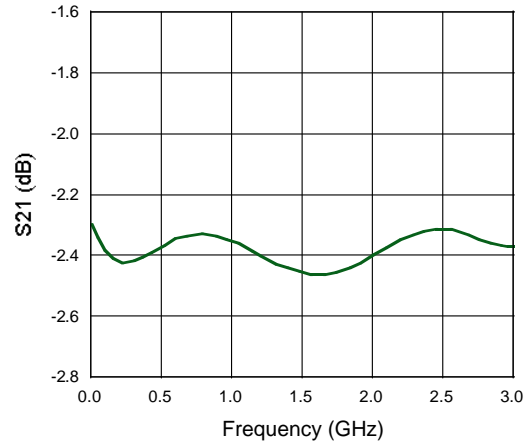

**Return Loss vs. Control Voltage, F = 900 MHz**

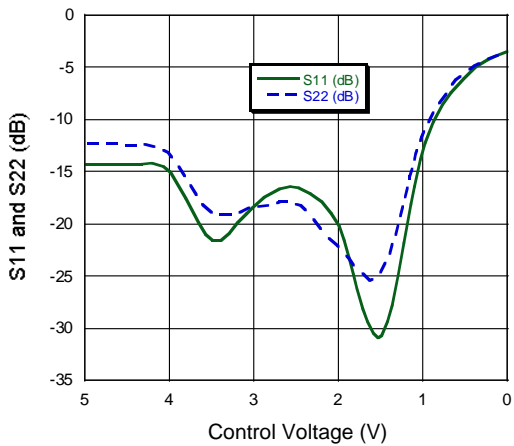

**Return Loss vs. Control Voltage, F = 1800 MHz**

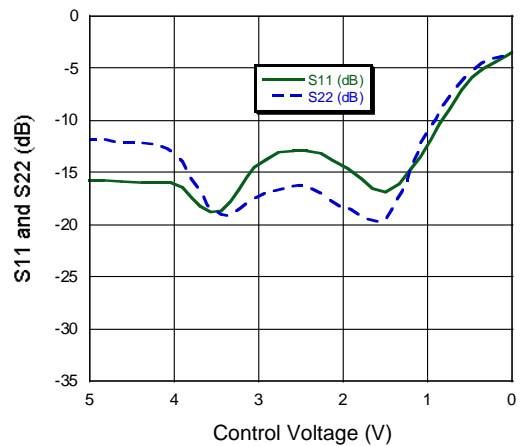

**Return Loss vs. Control Voltage, F = 2200 MHz**

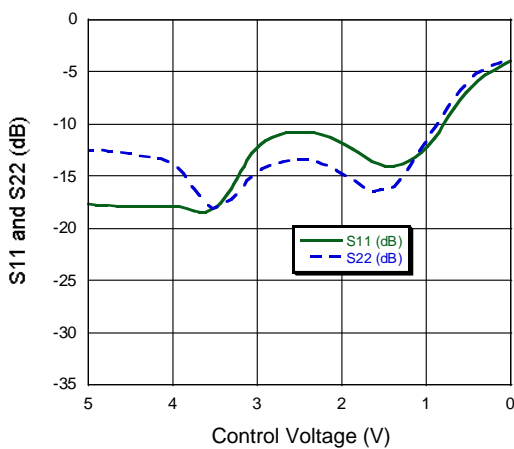

**Maximum Attenuation vs. Frequency**

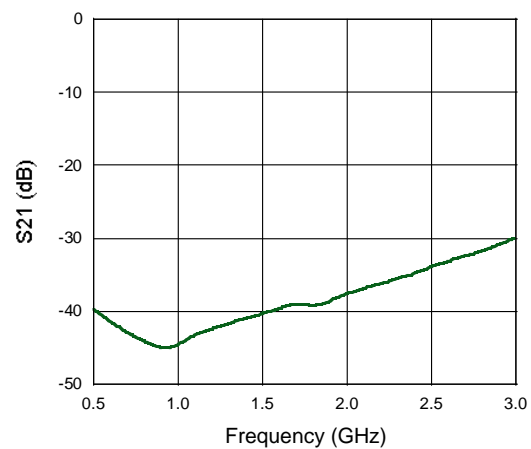

3

**ADVANCED:** Data Sheets contain information regarding a product M/A-COM Technology Solutions is considering for development. Performance is based on target specifications, simulated results, and/or prototype measurements. Commitment to develop is not guaranteed.  
**PRELIMINARY:** Data Sheets contain information regarding a product M/A-COM Technology Solutions has under development. Performance is based on engineering tests. Specifications are typical. Mechanical outline has been fixed. Engineering samples and/or test data may be available. Commitment to produce in volume is not guaranteed.

- **North America** Tel: 800.366.2266 / Fax: 978.366.2266
- **Europe** Tel: 44.1908.574.200 / Fax: 44.1908.574.300
- **Asia/Pacific** Tel: 81.44.844.8296 / Fax: 81.44.844.8298

Visit [www.macomtech.com](http://www.macomtech.com) for additional data sheets and product information.

M/A-COM Technology Solutions Inc. and its affiliates reserve the right to make changes to the product(s) or information contained herein without notice.

## Voltage Variable Absorptive Attenuator 40 dB, 0.5 - 3.0 GHz

Rev. V7

### Typical Performance Curves @ 25°C

1 dB Compression vs. Control Voltage,  $F = 900$  MHz

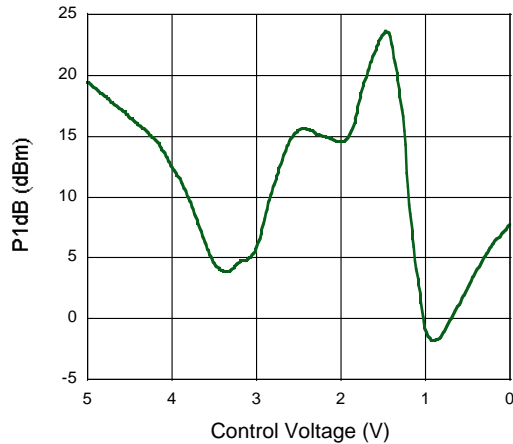

IP3 vs. Control Voltage

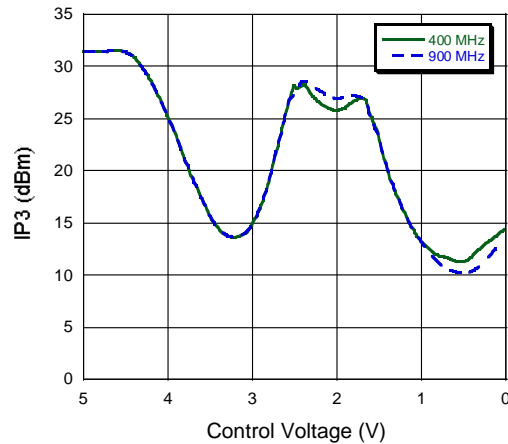

Attenuation vs. Temperature  
Normalized to 25°C,  $F = 900$  MHz

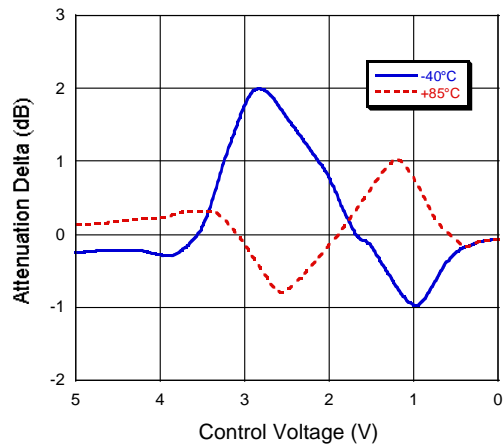

### Handling Procedures

Please observe the following precautions to avoid damage:

### Static Sensitivity

Gallium Arsenide Integrated Circuits are sensitive to electrostatic discharge (ESD) and can be damaged by static electricity. Proper ESD control techniques should be used when handling these devices.