

MABA-010268-CT4160



Transformer, 1:4 Transmission Line Transformer
5 to 1200 MHz

Rev. V1

Features

- 1:4 Impedance ratio
- Surface mount
- Available on tape and reel
- 260°C reflow compatible
- RoHS* compliant and lead free
- Excellent temperature stability
- Excellent amplitude and phase balance
- Can be used in both 50Ω and 75Ω systems

Description

M/ACom Technology Solutions MABA-010268-CT4160 is a 1:4 RF transmission line transformer in a low cost, surface mount package. Ideally suited for broadband CATV applications.



Schematic

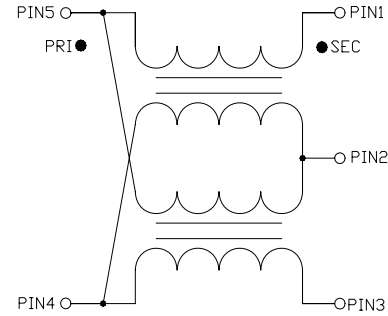

Component dimensions

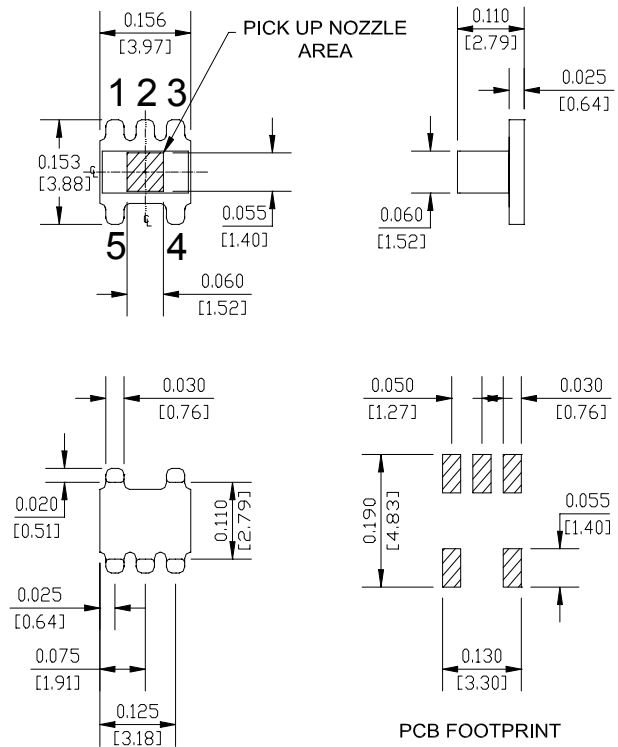

Dimensions in inches [mm] Tolerance: .xx ± .02, .xxx ± .010, unless otherwise stated

Pin Configuration

Pin no.	Function
1	Secondary Dot
2	Secondary Centre Tap
3	Secondary
4	Primary
5	Primary Dot

* Restrictions on Hazardous Substances, European Union Directive 2002/95/EC.

ADVANCED: Data Sheets contain information regarding a product M/A-COM Technology Solutions is considering for development. Performance is based on target specifications, simulated results, and/or prototype measurements. Commitment to develop is not guaranteed.
PRELIMINARY: Data Sheets contain information regarding a product M/A-COM Technology Solutions has under development. Performance is based on engineering tests. Specifications are typical. Mechanical outline has been fixed. Engineering samples and/or test data may be available. Commitment to produce in volume is not guaranteed.

• **North America** Tel: 800.366.2266 • **Europe** Tel: +353.21.244.6400
 • **India** Tel: +91.80.43537383 • **China** Tel: +86.21.2407.1588
 Visit www.macomtech.com for additional data sheets and product information.

M/A-COM Technology Solutions Inc. and its affiliates reserve the right to make changes to the product(s) or information contained herein without notice.

Electrical Specifications: $T_A = 25^\circ\text{C}$, 0dBm, $Z_0 = 50\Omega$, $P_{in} = 0\text{dBm}$

Parameter	Frequency	Units	Min	Typ	Max
Insertion Loss 1 (Pin 4 to Pin 1)	5 - 50MHz	dB	-	0.5	0.7
	50 - 879MHz	dB	-	0.7	1.5
	879 - 1200MHz	dB	-	1.2	2.0
Insertion Loss 2 (Pin 4 to Pin 3)	5 - 50MHz	dB	-	0.5	0.7
	50 - 879MHz	dB	-	0.6	1.2
	879 - 1200MHz	dB	-	0.8	1.6
Amplitude Balance (Nominal 0dB)	5 - 500MHz	dB	-	0.05	± 0.6
	500 - 1200MHz	dB	-	0.23	± 2.1
Phase Balance (Nominal 180°)	5 - 500MHz	°	-	1.4	± 6
	500 - 1000MHz	°	-	2.8	± 8
	1000 - 1200MHz	°	-	0.2	± 22
Input Return Loss (Pin4)	5 - 50 MHz	dB	20	25	-
	50 - 500 MHz	dB	15	23	-
	500 - 1200 MHz	dB	11	16	-

Recommended Maximum Ratings

Parameter	Value
Input power	At least +28dBm (631mW)
DC current (tested at 5V)	At least 600mA
Operating Temperature	-40°C to +85°C
Storage Temperature	-55°C to +100°C

Application Circuit

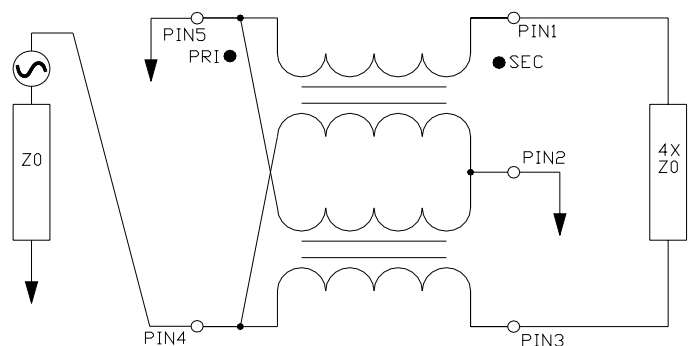

Typical Performance Curves: $T_A = 25^\circ\text{C}$, 0dBm , $Z_0 = 50\Omega$, $P_{in} = 0\text{dBm}$

Insertion Loss 1: (Pin 4 to 1)

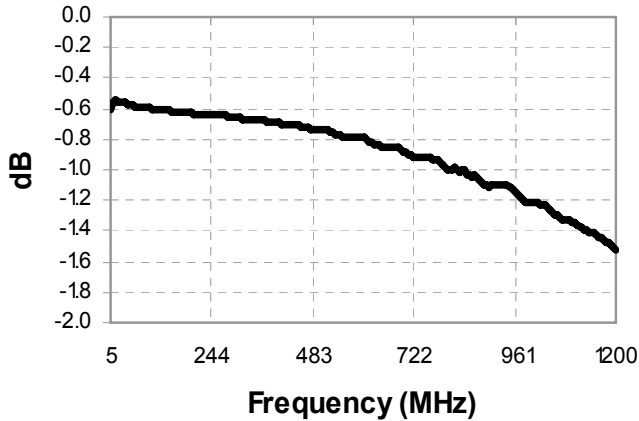

Insertion Loss 2: (Pin 4 to 3)

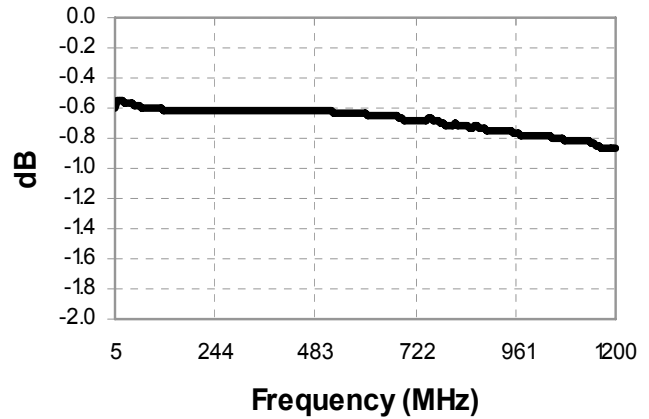

Amplitude Balance

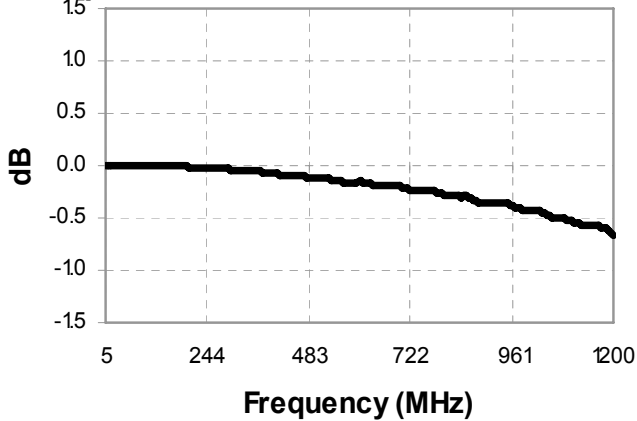

Phase Balance

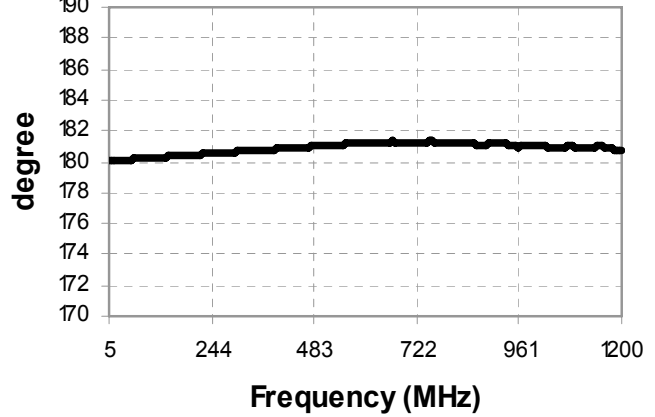

Return Loss: Input (Pin 4)

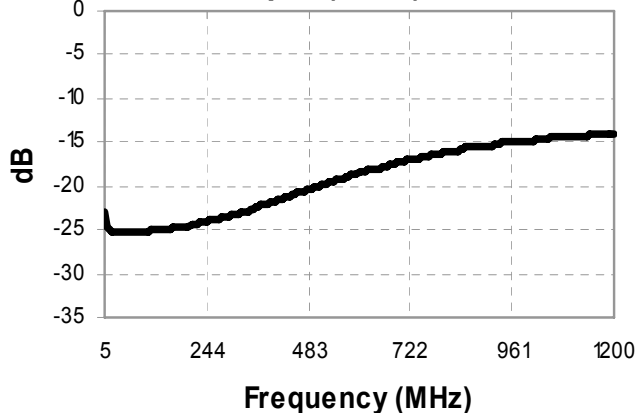

Tape & Reel Information

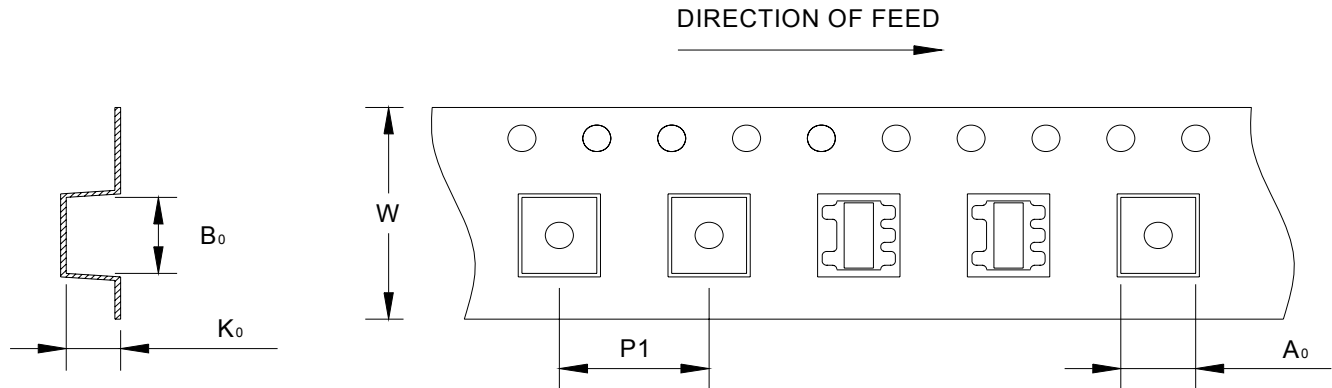

Item	Dimension
Ao	4.00mm +/- 0.1mm
Bo	4.30mm +/- 0.1mm
Ko	2.90mm +/- 0.1mm
W	12.0mm +/- 0.3mm
P1	8.00mm +/- 0.1mm

Ordering Information

Part number	Description
MABA-010268-CT4160	2000 piece reel