

# MITSUBISHI IGBT MODULES CM200DY-28H

HIGH POWER SWITCHING USE  
INSULATED TYPE

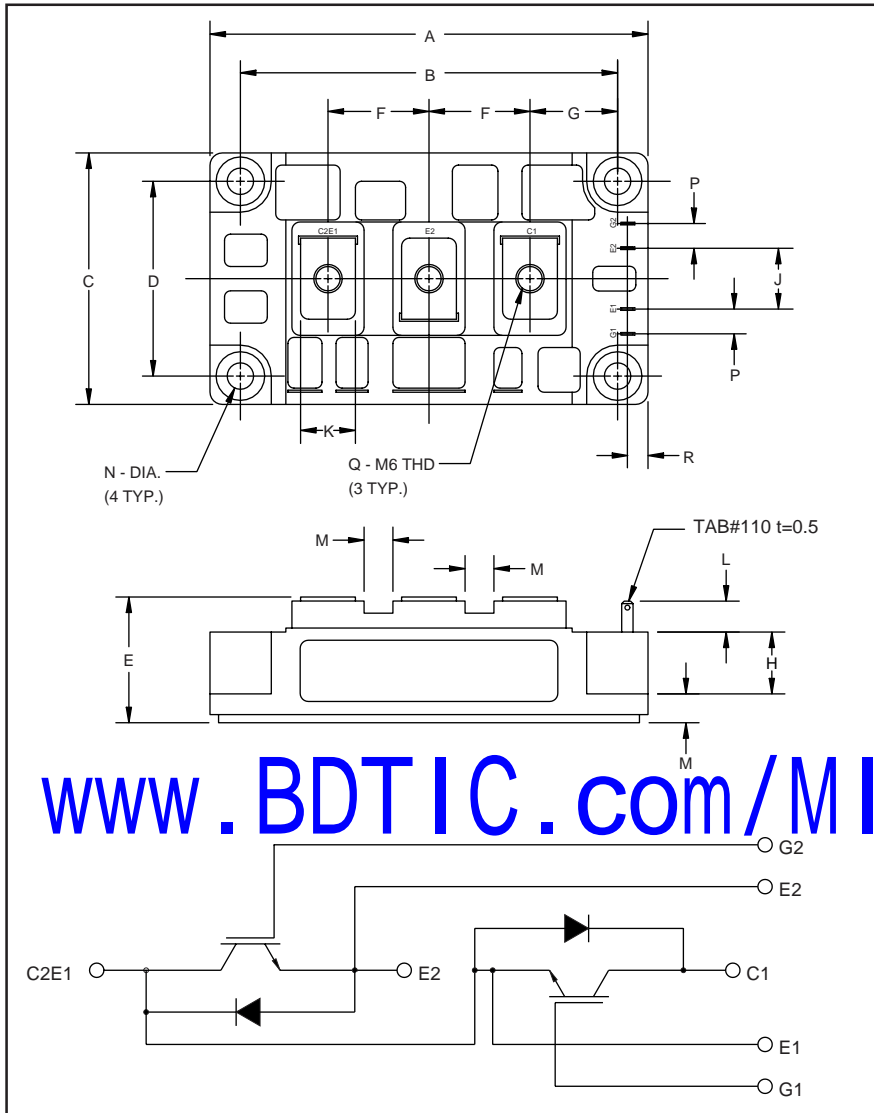

### Description:

Mitsubishi IGBT Modules are designed for use in switching applications. Each module consists of two IGBTs in a half-bridge configuration with each transistor having a reverse-connected super-fast recovery free-wheel diode. All components and interconnects are isolated from the heat sinking baseplate, offering simplified system assembly and thermal management.

### Features:

- Low Drive Power
- Low  $V_{CE(sat)}$
- Discrete Super-Fast Recovery Free-Wheel Diode
- High Frequency Operation
- Isolated Baseplate for Easy Heat Sinking

### Applications:

- AC Motor Control
- Motion/Servo Control
- UPS
- Welding Power Supplies

### Ordering Information:

Example: Select the complete part module number you desire from the table below -i.e. CM200DY-28H is a 1400V ( $V_{CES}$ ), 200 Amper Dual IGBT Module.

Type	Current Rating Amperes	$V_{CES}$ Volts (x 50)
CM	200	28

Outline Drawing and Circuit Diagram

Dimensions	Inches	Millimeters
A	4.25	108.0
B	3.66±0.01	93.0±0.25
C	2.44	62.0
D	1.89±0.01	48.0±0.25
E	1.22 Max.	31.0 Max.
F	0.98	25.0
G	0.85	21.5
H	0.60	15.2

Dimensions	Inches	Millimeters
J	0.59	15.0
K	0.55	14.0
L	0.30	8.5
M	0.28	7.0
N	0.256 Dia.	Dia. 6.5
P	0.24	6.0
Q	M6 Metric	M6
R	0.20	5.0

[www.BDTIC.com/MITSUBISHI](http://www.BDTIC.com/MITSUBISHI)

## CM200DY-28H

HIGH POWER SWITCHING USE  
INSULATED TYPEAbsolute Maximum Ratings,  $T_j = 25\text{ }^\circ\text{C}$  unless otherwise specified

	Symbol	Ratings	Units
Junction Temperature	$T_j$	-40 to 150	$^\circ\text{C}$
Storage Temperature	$T_{\text{stg}}$	-40 to 125	$^\circ\text{C}$
Collector-Emitter Voltage (G-E SHORT)	$V_{\text{CES}}$	1400	Volts
Gate-Emitter Voltage (C-E SHORT)	$V_{\text{GES}}$	$\pm 20$	Volts
Collector Current ( $T_C = 25\text{ }^\circ\text{C}$ )	$I_C$	200	Amperes
Peak Collector Current	$I_{\text{CM}}$	400*	Amperes
Emitter Current** ( $T_C = 25\text{ }^\circ\text{C}$ )	$I_E$	200	Amperes
Peak Emitter Current**	$I_{\text{EM}}$	400*	Amperes
Maximum Collector Dissipation ( $T_C = 25\text{ }^\circ\text{C}$ , $T_j \leq 150\text{ }^\circ\text{C}$ )	$P_c$	1500	Watts
Mounting Torque, M6 Main Terminal	-	1.96 ~ 2.94	N · m
Mounting Torque, M6 Mounting	-	1.96 ~ 2.94	N · m
Weight	-	400	Grams
Isolation Voltage (Main Terminal to Baseplate, AC 1 min.)	$V_{\text{iso}}$	2500	Vrms

\*Pulse width and repetition rate should be such that the device junction temperature ( $T_j$ ) does not exceed  $T_{j(\text{max})}$  rating.

\*\*Represents characteristics of the anti-parallel, emitter-to-collector free-wheel diode (FWDi).

Static Electrical Characteristics,  $T_j = 25\text{ }^\circ\text{C}$  unless otherwise specified

Characteristics	Symbol	Test Conditions	Min.	Typ.	Max.	Units
Collector-Cutoff Current	$I_{\text{CES}}$	$V_{\text{CE}} = V_{\text{CES}}$ , $V_{\text{GE}} = 0\text{V}$	-	-	1.0	mA
Gate Leakage Current	$I_{\text{G}}$	$V_{\text{GE}} = V_{\text{GES}}$ , $V_{\text{CE}} = 10\text{V}$	-	-	0.5	$\mu\text{A}$
Gate-Emitter Threshold Voltage	$V_{\text{GE(th)}}$	$I_C = 20\text{mA}$ , $V_{\text{CE}} = 10\text{V}$	5.0	6.5	8.0	Volts
Collector-Emitter Saturation Voltage	$V_{\text{CE(sat)}}$	$I_C = 200\text{A}$ , $V_{\text{GE}} = 15\text{V}$	-	3.1	4.2**	Volts
		$I_C = 200\text{A}$ , $V_{\text{GE}} = 15\text{V}$ , $T_j = 150\text{ }^\circ\text{C}$	-	2.95	-	Volts
Total Gate Charge	$Q_G$	$V_{\text{CC}} = 800\text{V}$ , $I_C = 200\text{A}$ , $V_{\text{GE}} = 15\text{V}$	-	1020	-	nC
Emitter-Collector Voltage	$V_{\text{EC}}$	$I_E = 200\text{A}$ , $V_{\text{GE}} = 0\text{V}$	-	-	3.8	Volts

\*\* Pulse width and repetition rate should be such that device junction temperature rise is negligible.

Dynamic Electrical Characteristics,  $T_j = 25\text{ }^\circ\text{C}$  unless otherwise specified

Characteristics	Symbol	Test Conditions	Min.	Typ.	Max.	Units
Input Capacitance	$C_{\text{ies}}$		-	-	40	nF
Output Capacitance	$C_{\text{oes}}$	$V_{\text{GE}} = 0\text{V}$ , $V_{\text{CE}} = 10\text{V}$	-	-	14	nF
Reverse Transfer Capacitance	$C_{\text{res}}$		-	-	8	nF
Resistive	Turn-on Delay Time	$t_{\text{d(on)}}$	-	-	250	ns
Load	Rise Time	$t_r$	-	-	400	ns
Switching	Turn-off Delay Time	$t_{\text{d(off)}}$	-	-	300	ns
Times	Fall Time	$t_f$	-	-	500	ns
Diode Reverse Recovery Time	$t_{\text{rr}}$	$I_E = 200\text{A}$ , $di_E/dt = -400\text{A}/\mu\text{s}$	-	-	300	ns
Diode Reverse Recovery Charge	$Q_{\text{rr}}$	$I_E = 200\text{A}$ , $di_E/dt = -400\text{A}/\mu\text{s}$	-	2.0	-	$\mu\text{C}$

Thermal and Mechanical Characteristics,  $T_j = 25\text{ }^\circ\text{C}$  unless otherwise specified

Characteristics	Symbol	Test Conditions	Min.	Typ.	Max.	Units
Thermal Resistance, Junction to Case	$R_{\text{th(j-c)}}$	Per IGBT	-	-	0.085	$^\circ\text{C}/\text{W}$
Thermal Resistance, Junction to Case	$R_{\text{th(j-c)}}$	Per FWDi	-	-	0.18	$^\circ\text{C}/\text{W}$
Contact Thermal Resistance	$R_{\text{th(c-f)}}$	Per Module, Thermal Grease Applied	-	-	0.045	$^\circ\text{C}/\text{W}$

# CM200DY-28H

HIGH POWER SWITCHING USE  
INSULATED TYPE

OUTPUT CHARACTERISTICS  
(TYPICAL)

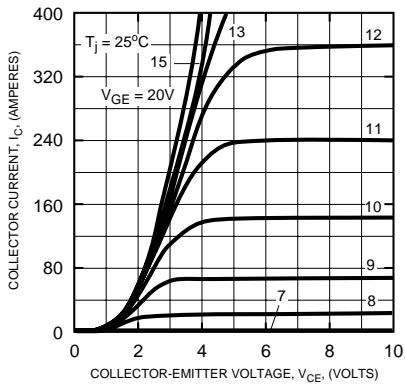

TRANSFER CHARACTERISTICS  
(TYPICAL)

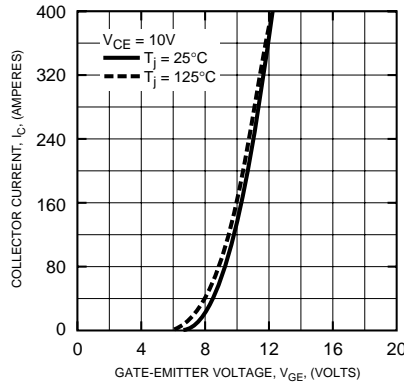

COLLECTOR-EMITTER SATURATION VOLTAGE CHARACTERISTICS  
(TYPICAL)

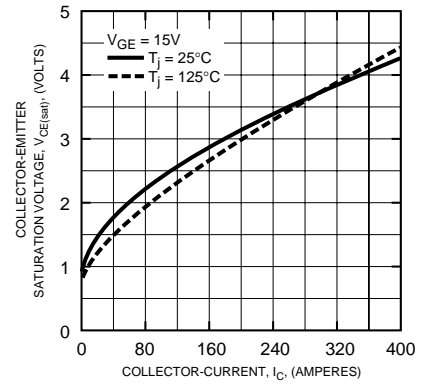

COLLECTOR-EMITTER SATURATION VOLTAGE CHARACTERISTICS  
(TYPICAL)

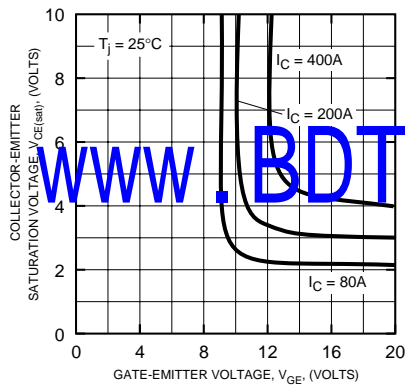

FREE-WHEEL DIODE FORWARD CHARACTERISTICS  
(TYPICAL)

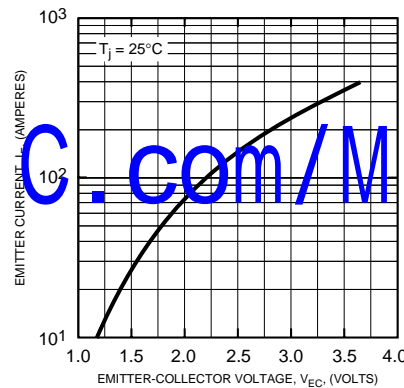

CAPACITANCE VS.  $V_{CE}$   
(TYPICAL)

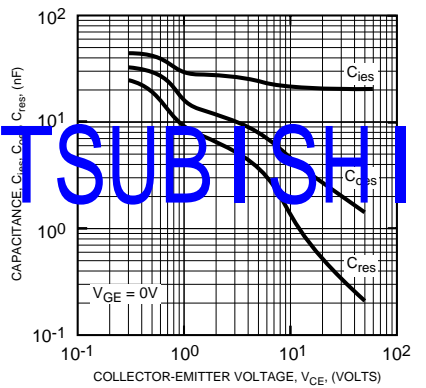

HALF-BRIDGE SWITCHING CHARACTERISTICS  
(TYPICAL)

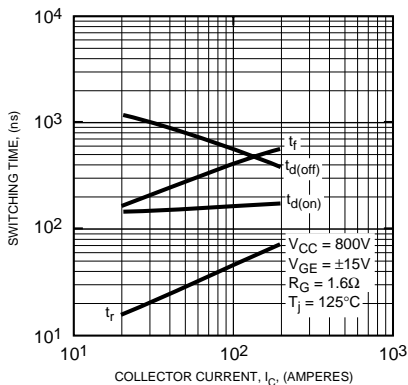

REVERSE RECOVERY CHARACTERISTICS  
(TYPICAL)

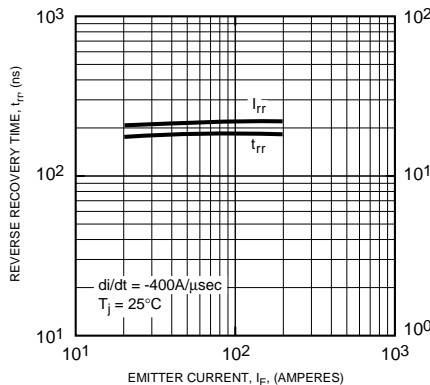

GATE CHARGE,  $V_{GE}$

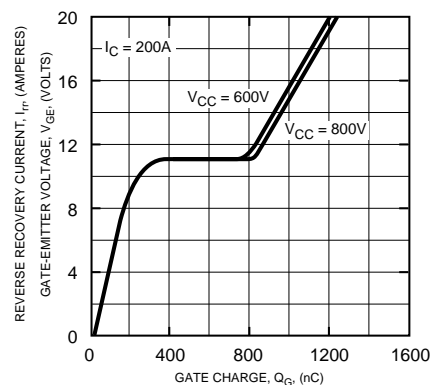

**CM200DY-28H**

HIGH POWER SWITCHING USE  
INSULATED TYPE

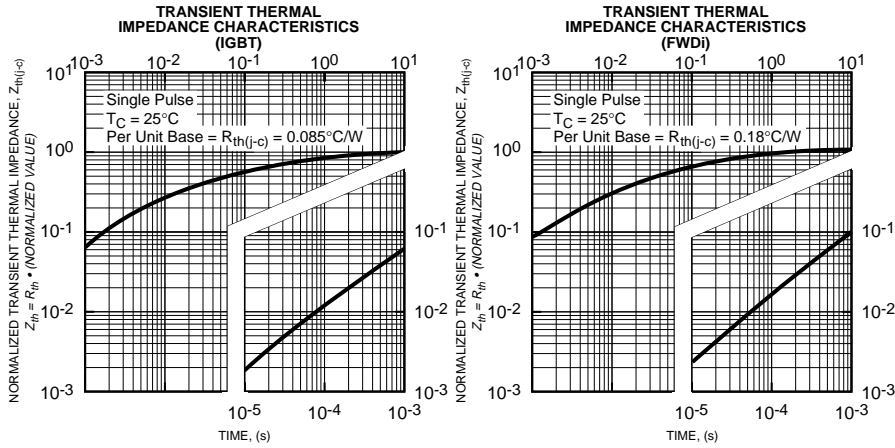

[www.BDTIC.com/MITSUBISHI](http://www.BDTIC.com/MITSUBISHI)