

# MITSUBISHI IGBT MODULES

## CM50TF-28H

MEDIUM POWER SWITCHING USE  
INSULATED TYPE

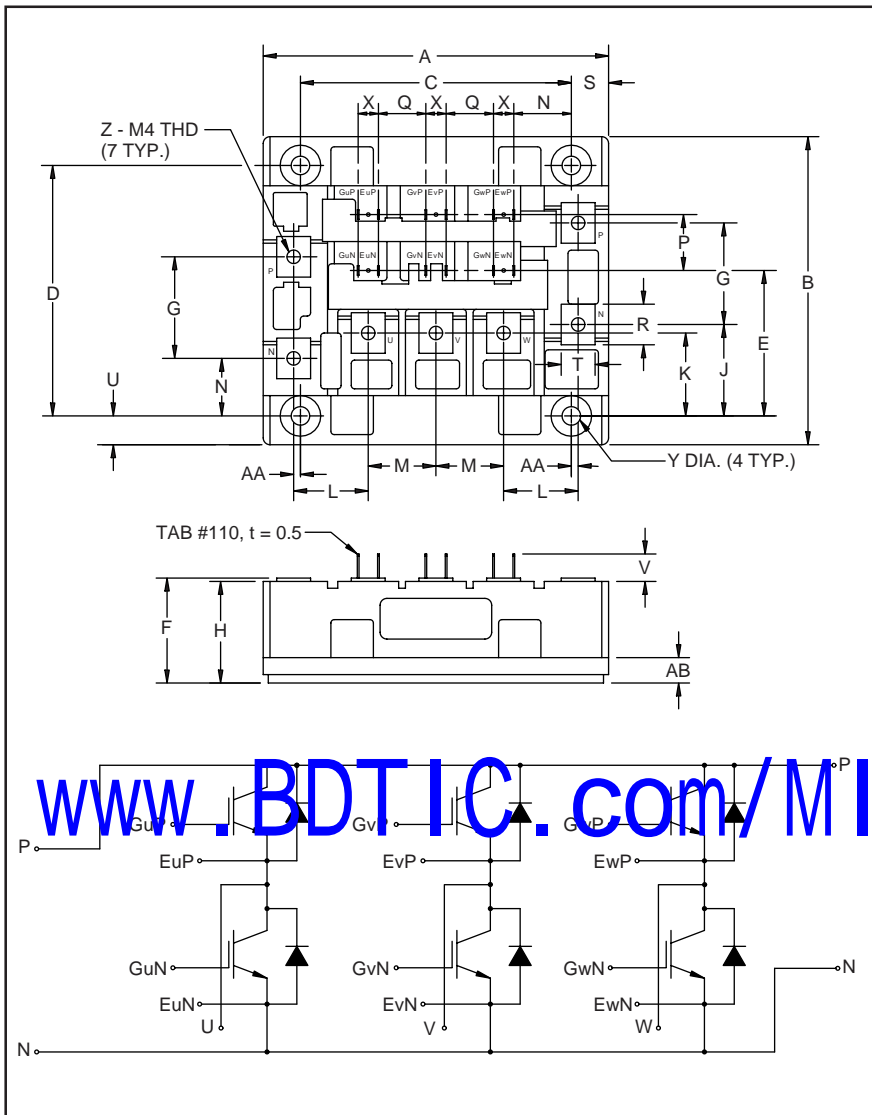

### Description:

Mitsubishi IGBT Modules are designed for use in switching applications. Each module consists of six IGBTs in a three phase bridge configuration, with each transistor having a reverse-connected super-fast recovery free-wheel diode. All components and interconnects are isolated from the heat sinking baseplate, offering simplified system assembly and thermal management.

### Features:

- Low Drive Power
- Low  $V_{CE(sat)}$
- Discrete Super-Fast Recovery Free-Wheel Diode
- High Frequency Operation
- Isolated Baseplate for Easy Heat Sinking

### Applications:

- AC Motor Control
- Motion/Servo Control
- UPS
- Welding Power Supplies

### Ordering Information:

Example: Select the complete part module number you desire from the table below -i.e. CM50TF-28H is a 1400V ( $V_{CES}$ ), 50 Ampere Six-IGBT Module.

Type	Current Rating Amperes	$V_{CES}$ Volts (x 50)
CM	50	28

Outline Drawing and Circuit Diagram

Dimensions	Inches	Millimeters
A	4.02±0.02	102.0±0.5
B	3.58±0.02	91.0±0.5
C	3.150±0.01	80.0±0.25
D	2.913±0.01	74.0±0.25
E	1.69	43.0
F	1.18 +0.06/-0.02	30 +1.5/-0.5
G	1.18	30.0
H	1.16	29.5
J	1.06	27.0
K	0.96	24.5
L	0.87	22.0
M	0.79	20.0
N	0.67	17.0

Dimensions	Inches	Millimeters
P	0.65	16.5
Q	0.55	14.0
R	0.47	12.0
S	0.43	11.0
T	0.39	10.0
U	0.33	8.5
V	0.32	8.1
X	0.24	6.0
Y	0.22 Dia.	Dia. 5.5
Z	M4 Metric	M4
AA	0.08	2.0
AB	0.28	7.0

# CM50TF-28H

MEDIUM POWER SWITCHING USE  
INSULATED TYPE

## Absolute Maximum Ratings, $T_j = 25\text{ }^\circ\text{C}$ unless otherwise specified

	Symbol	Ratings	Units
Junction Temperature	$T_j$	-40 to 150	$^\circ\text{C}$
Storage Temperature	$T_{stg}$	-40 to 125	$^\circ\text{C}$
Collector-Emitter Voltage (G-E-SHORT)	$V_{CES}$	1400	Volts
Gate-Emitter Voltage (C-E-SHORT)	$V_{GES}$	$\pm 20$	Volts
Collector Current ( $T_C = 25\text{ }^\circ\text{C}$ )	$I_C$	50	Amperes
Peak Collector Current	$I_{CM}$	100*	Amperes
Emitter Current** ( $T_C = 25\text{ }^\circ\text{C}$ )	$I_E$	50	Amperes
Peak Emitter Current**	$I_{EM}$	100*	Amperes
Maximum Collector Dissipation ( $T_C = 25\text{ }^\circ\text{C}$ , $T_j \leq 150\text{ }^\circ\text{C}$ )	$P_c$	400	Watts
Mounting Torque, M4 Main Terminal	-	0.98 ~ 1.47	N · m
Mounting Torque, M5 Mounting	-	1.47 ~ 1.96	N · m
Weight	-	540	Grams
Isolation Voltage (Main Terminal to Baseplate, AC 1 min.)	$V_{iso}$	2500	Vrms

\*Pulse width and repetition rate should be such that the device junction temperature ( $T_j$ ) does not exceed  $T_{j(max)}$  rating.

\*\*Represents characteristics of the anti-parallel, emitter-to-collector free-wheel diode (FWDi).

## Static Electrical Characteristics, $T_j = 25\text{ }^\circ\text{C}$ unless otherwise specified

Characteristics	Symbol	Test Conditions	Min.	Typ.	Max.	Units
Collector-Cutoff Current	$I_{CES}$	$V_{CE} = V_{CES}$ , $V_{GE} = 0V$	-	-	1.0	mA
Gate Leakage Current	$I_{G}$	$V_{GE} = V_{GES}$ , $V_{CE} = 0V$	-	-	0.5	$\mu\text{A}$
Gate-Emitter Threshold Voltage	$V_{GE(th)}$	$I_C = 3\text{ mA}$ , $V_{CE} = 10V$	5.0	6.5	8.0	Volts
Collector-Emitter Saturation Voltage	$V_{CE(sat)}$	$I_C = 50A$ , $V_{GE} = 15V$	-	3.1	4.2**	Volts
		$I_C = 50A$ , $V_{GE} = 15V$ , $T_j = 150\text{ }^\circ\text{C}$	-	2.95	-	Volts
Total Gate Charge	$Q_G$	$V_{CC} = 800V$ , $I_C = 50A$ , $V_{GE} = 15V$	-	255	-	nC
Emitter-Collector Voltage	$V_{EC}$	$I_E = 50A$ , $V_{GE} = 0V$	-	-	3.8	Volts

\*\* Pulse width and repetition rate should be such that device junction temperature rise is negligible.

## Dynamic Electrical Characteristics, $T_j = 25\text{ }^\circ\text{C}$ unless otherwise specified

Characteristics	Symbol	Test Conditions	Min.	Typ.	Max.	Units
Input Capacitance	$C_{ies}$		-	-	10	nF
Output Capacitance	$C_{oes}$	$V_{GE} = 0V$ , $V_{CE} = 10V$	-	-	3.5	nF
Reverse Transfer Capacitance	$C_{res}$		-	-	2	nF
Resistive	Turn-on Delay Time	$t_{d(on)}$	-	-	100	ns
Load	Rise Time	$t_r$	-	-	250	ns
Switching	Turn-off Delay Time	$t_{d(off)}$	-	-	150	ns
Times	Fall Time	$t_f$	-	-	500	ns
Diode Reverse Recovery Time	$t_{rr}$	$I_E = 50A$ , $di_E/dt = -100A/\mu\text{s}$	-	-	300	ns
Diode Reverse Recovery Charge	$Q_{rr}$	$I_E = 50A$ , $di_E/dt = -100A/\mu\text{s}$	-	0.5	-	$\mu\text{C}$

## Thermal and Mechanical Characteristics, $T_j = 25\text{ }^\circ\text{C}$ unless otherwise specified

Characteristics	Symbol	Test Conditions	Min.	Typ.	Max.	Units
Thermal Resistance, Junction to Case	$R_{th(j-c)}$	Per IGBT	-	-	0.31	$^\circ\text{C/W}$
Thermal Resistance, Junction to Case	$R_{th(j-c)}$	Per FWDi	-	-	0.70	$^\circ\text{C/W}$
Contact Thermal Resistance	$R_{th(c-f)}$	Per Module, Thermal Grease Applied	-	-	0.033	$^\circ\text{C/W}$

# CM50TF-28H

MEDIUM POWER SWITCHING USE  
INSULATED TYPE

OUTPUT CHARACTERISTICS  
(TYPICAL)

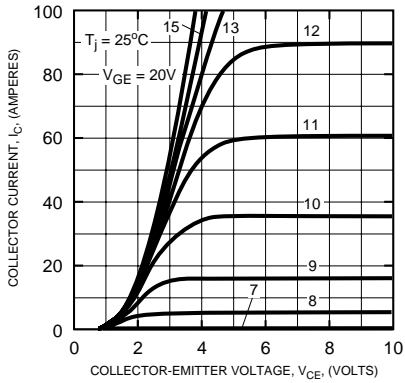

TRANSFER CHARACTERISTICS  
(TYPICAL)

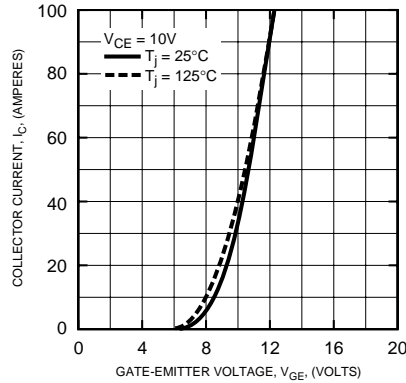

COLLECTOR-EMITTER SATURATION VOLTAGE CHARACTERISTICS  
(TYPICAL)

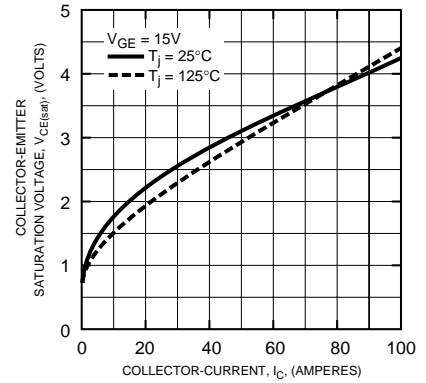

COLLECTOR-EMITTER SATURATION VOLTAGE CHARACTERISTICS  
(TYPICAL)

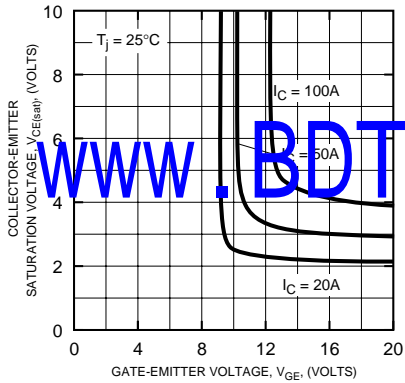

FREE-WHEEL DIODE FORWARD CHARACTERISTICS  
(TYPICAL)

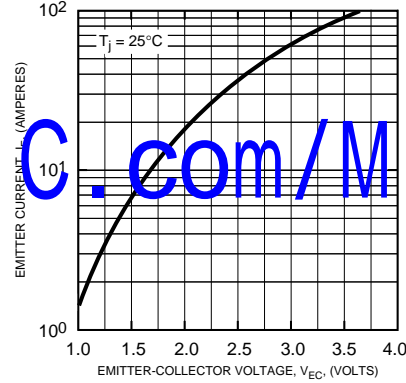

CAPACITANCE VS.  $V_{CE}$   
(TYPICAL)

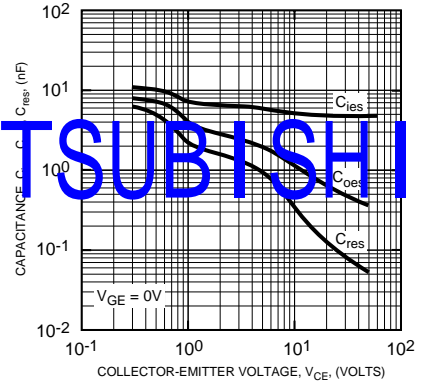

HALF-BRIDGE SWITCHING CHARACTERISTICS  
(TYPICAL)

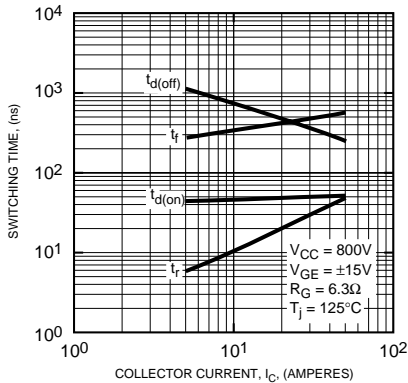

REVERSE RECOVERY CHARACTERISTICS  
(TYPICAL)

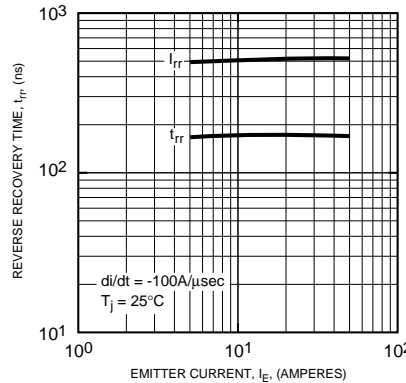

GATE CHARGE,  $V_{GE}$

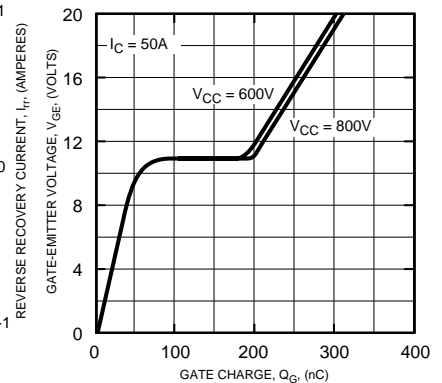

**CM50TF-28H**

MEDIUM POWER SWITCHING USE  
INSULATED TYPE

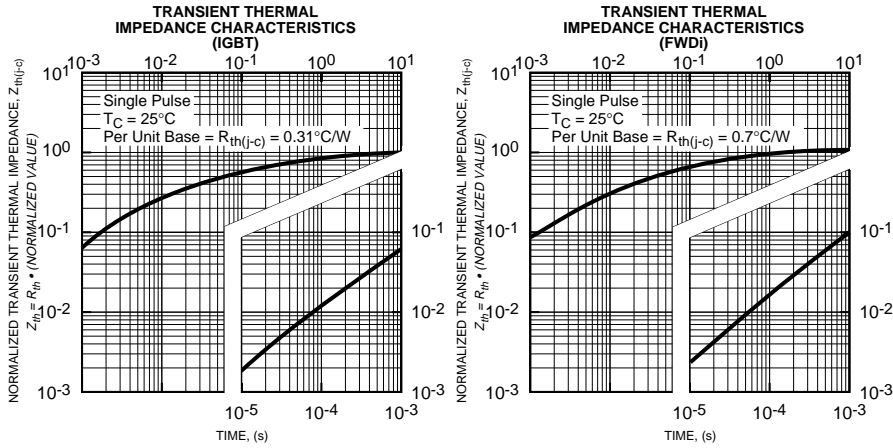

[www.BDTIC.com/MITSUBISHI](http://www.BDTIC.com/MITSUBISHI)