

MITSUBISHI IGBT MODULES
CM75TU-12H
 HIGH POWER SWITCHING USE
 INSULATED TYPE

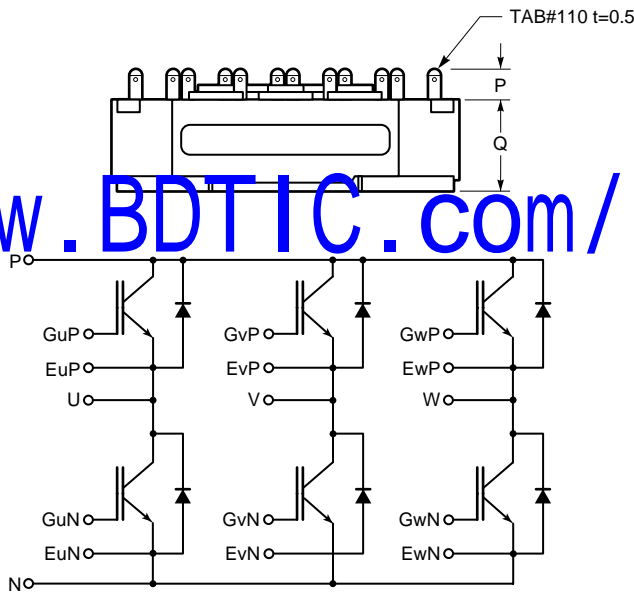
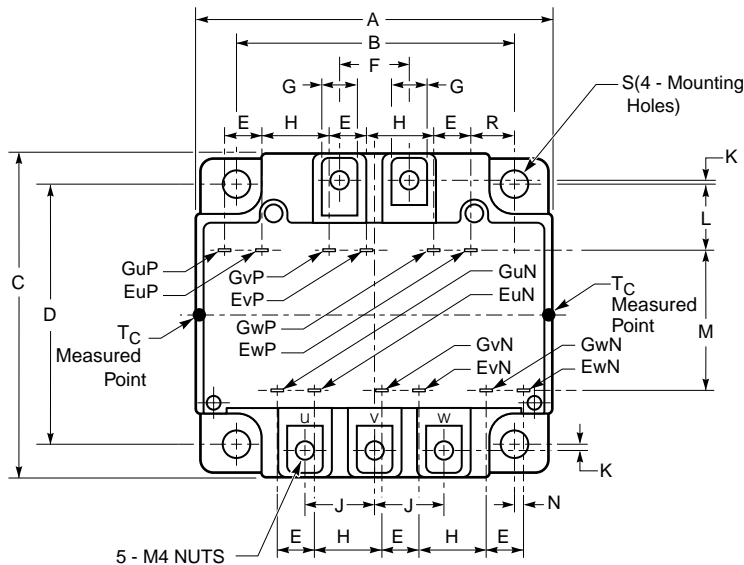
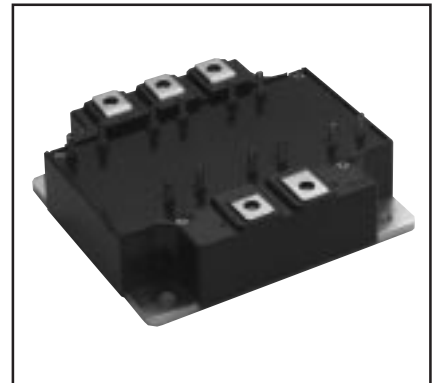

Description:

Mitsubishi IGBT Modules are designed for use in switching applications. Each module consists of six IGBTs in a three phase bridge configuration, with each transistor having a reverse-connected super-fast recovery free-wheel diode. All components and interconnects are isolated from the heat sinking baseplate, offering simplified system assembly and thermal management.

Features:

- Low Drive Power
- Low V_{CE(sat)}
- Discrete Super-Fast Recovery Free-Wheel Diode
- High Frequency Operation
- Isolated Baseplate for Easy Heat Sinking

Applications:

- AC Motor Control
- Motion/Servo Control
- UPS
- Welding Power Supplies

Ordering Information:

Example: Select the complete module number you desire from the table - i.e. CM75TU-12H is a 600V (V_{CE(s)}), 75 Ampere Six-IGBT Module.

Type	Current Rating Amperes	V _{CE(s)} Volts (x 50)
CM	75	12

Outline Drawing and Circuit Diagram

Dimensions	Inches	Millimeters
A	4.02	102.0
B	3.15±0.01	80.0±0.25
C	3.58	91.0
D	2.91±0.01	74.0±0.25
E	0.43	11.0
F	0.79	20.0
G	0.39	10.0
H	0.75	19.1
J	0.79	20.0

Dimensions	Inches	Millimeters
K	0.05	1.25
L	0.74	18.7
M	1.55	39.3
N	0.12	3.05
P	0.32	8.1
Q	1.02	26.0
R	0.47	11.85
S	0.22 Dia.	5.5 Dia.

CM75TU-12H

HIGH POWER SWITCHING USE
INSULATED TYPEAbsolute Maximum Ratings, $T_j = 25\text{ }^\circ\text{C}$ unless otherwise specified

	Symbol	Ratings	Units
Junction Temperature	T_j	-40 to 150	$^\circ\text{C}$
Storage Temperature	T_{stg}	-40 to 125	$^\circ\text{C}$
Collector-Emitter Voltage (G-E SHORT)	V_{CES}	600	Volts
Gate-Emitter Voltage (C-E SHORT)	V_{GES}	± 20	Volts
Collector Current ($T_c = 25^\circ\text{C}$)	I_C	75	Amperes
Peak Collector Current ($T_j \leq 150^\circ\text{C}$)	I_{CM}	150*	Amperes
Emitter Current**	I_E	75	Amperes
Peak Emitter Current**	I_{EM}	150*	Amperes
Maximum Collector Dissipation ($T_j < 150^\circ\text{C}$)	P_C	310	Watts
Mounting Torque, M4 Main Terminal	–	1.3 ~ 1.7	N · m
Mounting Torque, M5 Mounting	–	2.5 ~ 3.5	N · m
Weight	–	570	Grams
Isolation Voltage (Main Terminal to Baseplate, AC 1 min.)	V_{iso}	2500	Vrms

* Pulse width and repetition rate should be such that the device junction temperature (T_j) does not exceed $T_{j(\text{max})}$ rating.

**Represents characteristics of the anti-parallel, emitter-to-collector free-wheel diode (FWDI).

Static Electrical Characteristics, $T_j = 25\text{ }^\circ\text{C}$ unless otherwise specified

Characteristics	Symbol	Test Conditions	Min.	Typ.	Max.	Units
Collector-Cutoff Current	I_{CES}	$V_{\text{CE}} = V_{\text{CES}}, V_{\text{GE}} = 0\text{V}$	–	–	1	mA
Gate Leakage Voltage	I_{GES}	$V_{\text{GE}} = V_{\text{GES}}, V_{\text{CE}} = 10\text{V}$	–	–	0.6	μA
Gate-Emitter Threshold Voltage	$V_{\text{GE(th)}}$	$I_C = 7.5\text{mA}, V_{\text{CE}} = 10\text{V}$	–	–	7.5	Volts
Collector-Emitter Saturation Voltage	$V_{\text{CE(sat)}}$	$I_C = 75\text{A}, V_{\text{GE}} = 15\text{V}, T_j = 25^\circ\text{C}$	–	2.4	3.0	Volts
		$I_C = 75\text{A}, V_{\text{GE}} = 15\text{V}, T_j = 125^\circ\text{C}$	–	2.6	–	Volts
Total Gate Charge	Q_G	$V_{\text{CC}} = 300\text{V}, I_C = 75\text{A}, V_{\text{GE}} = 15\text{V}$	–	150	–	nC
Emitter-Collector Voltage*	V_{EC}	$I_E = 75\text{A}, V_{\text{GE}} = 0\text{V}$	–	–	2.6	Volts

* Pulse width and repetition rate should be such that the device junction temperature (T_j) does not exceed $T_{j(\text{max})}$ rating.Dynamic Electrical Characteristics, $T_j = 25\text{ }^\circ\text{C}$ unless otherwise specified

Characteristics	Symbol	Test Conditions	Min.	Typ.	Max.	Units	
Input Capacitance	C_{ies}		–	–	6.6	nF	
Output Capacitance	C_{oes}	$V_{\text{CE}} = 10\text{V}, V_{\text{GE}} = 0\text{V}$	–	–	3.6	nF	
Reverse Transfer Capacitance	C_{res}		–	–	1	nF	
Resistive	Turn-on Delay Time	$t_{\text{d(on)}}$	$V_{\text{CC}} = 300\text{V}, I_C = 75\text{A},$	–	–	100	ns
Load	Rise Time	t_r	$V_{\text{GE1}} = V_{\text{GE2}} = 15\text{V},$	–	–	250	ns
Switch	Turn-off Delay Time	$t_{\text{d(off)}}$	$R_G = 8.3\Omega, \text{Resistive}$	–	–	200	ns
Times	Fall Time	t_f	Load Switching Operation	–	–	300	ns
Diode Reverse Recovery Time	t_{rr}	$I_E = 75\text{A}, di_E/dt = -150\text{A}/\mu\text{s}$	–	–	160	μC	
Diode Reverse Recovery Charge	Q_{rr}	$I_E = 75\text{A}, di_E/dt = -150\text{A}/\mu\text{s}$	–	0.18	–	μC	

Thermal and Mechanical Characteristics, $T_j = 25\text{ }^\circ\text{C}$ unless otherwise specified

Characteristics	Symbol	Test Conditions	Min.	Typ.	Max.	Units
Thermal Resistance, Junction to Case	$R_{\text{th(j-c)Q}}$	Per IGBT 1/6 Module	–	–	0.4	$^\circ\text{C}/\text{W}$
Thermal Resistance, Junction to Case	$R_{\text{th(j-c)D}}$	Per Free-Wheel Diode 1/6 Module	–	–	0.9	$^\circ\text{C}/\text{W}$
Contact Thermal Resistance	$R_{\text{th(c-f)}}$	Per Module, Thermal Grease Applied	–	0.018	–	$^\circ\text{C}/\text{W}$

CM75TU-12H

HIGH POWER SWITCHING USE
INSULATED TYPE

OUTPUT CHARACTERISTICS
(TYPICAL)

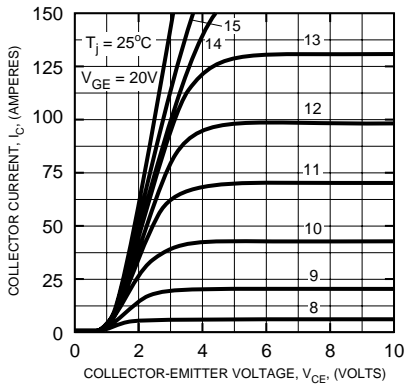

TRANSFER CHARACTERISTICS
(TYPICAL)

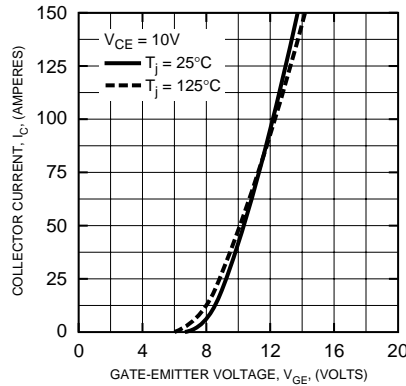

COLLECTOR-EMITTER
SATURATION VOLTAGE CHARACTERISTICS
(TYPICAL)

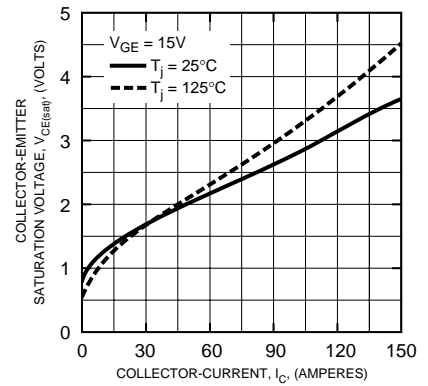

COLLECTOR-EMITTER
SATURATION VOLTAGE CHARACTERISTICS
(TYPICAL)

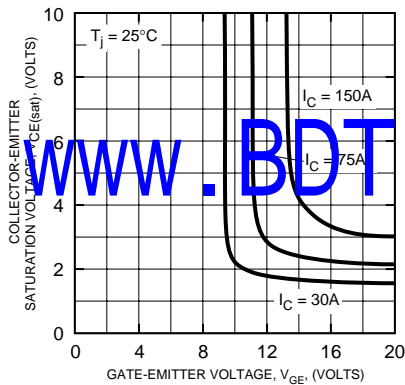

FREE-WHEEL DIODE
FORWARD CHARACTERISTICS
(TYPICAL)

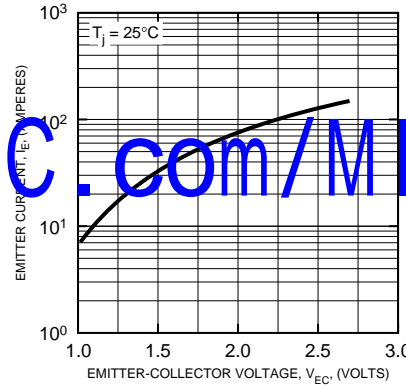

CAPACITANCE VS. V_{CE}
(TYPICAL)

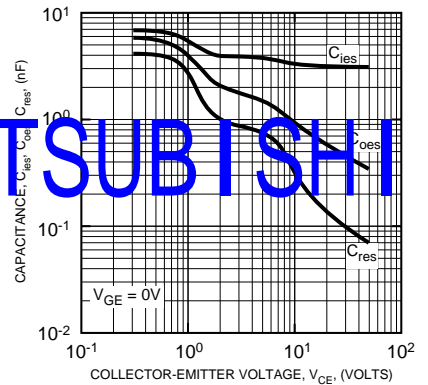

HALF-BRIDGE
SWITCHING CHARACTERISTICS
(TYPICAL)

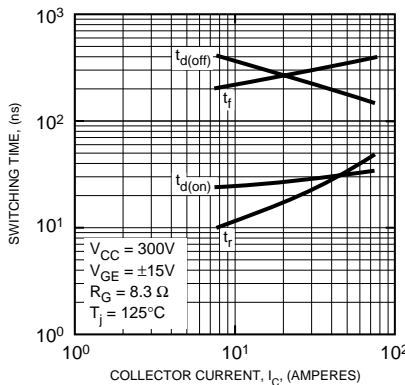

REVERSE RECOVERY CHARACTERISTICS
(TYPICAL)

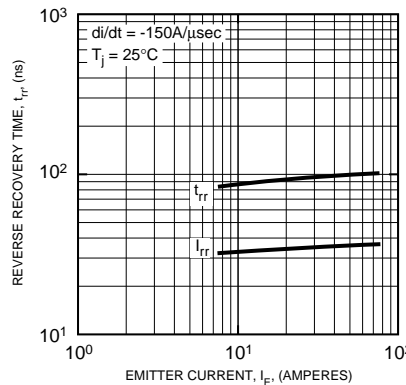

GATE CHARGE, V_{GE}

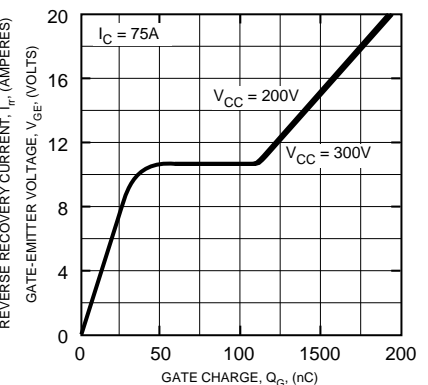

CM75TU-12H

HIGH POWER SWITCHING USE
INSULATED TYPE

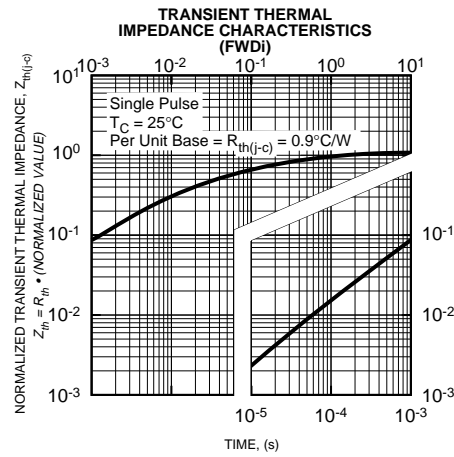
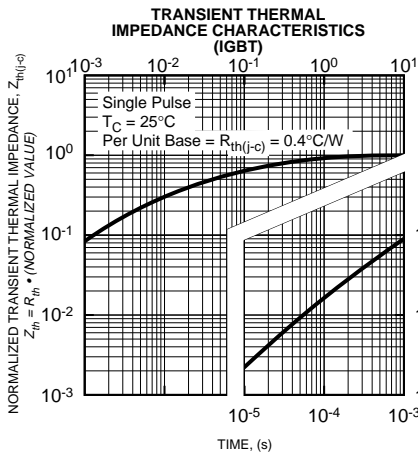

www.BDTIC.com/MITSUBISHI