

2N6284 (NPN); 2N6286, 2N6287 (PNP)

Preferred Device

Darlington Complementary Silicon Power Transistors

These packages are designed for general-purpose amplifier and low-frequency switching applications.

Features

- High DC Current Gain @ $I_C = 10 \text{ Adc}$ –
 $h_{FE} = 2400 \text{ (Typ)} - 2N6284$
 $= 4000 \text{ (Typ)} - 2N6287$
- Collector–Emitter Sustaining Voltage –
 $V_{CEO(sus)} = 100 \text{ Vdc (Min)}$
- Monolithic Construction with Built–In Base–Emitter Shunt Resistors
- Pb–Free Packages are Available*

MAXIMUM RATINGS (Note 1)

Rating	Symbol	Value	Unit
Collector–Emitter Voltage	V_{CEO}	80 100	Vdc
Collector–Base Voltage	V_{CB}	80 100	Vdc
Emitter–Base Voltage	V_{EB}	5.0	Vdc
Collector Current – Continuous Peak	I_C	20 40	Adc
Base Current	I_B	0.5	Adc
Total Power Dissipation @ $T_C = 25^\circ\text{C}$ Derate above 25°C	P_D	160 0.915	W W/ $^\circ\text{C}$
Operating and Storage Temperature Range	T_J, T_{stg}	–65 to +200	$^\circ\text{C}$

THERMAL CHARACTERISTICS (Note 1)

Characteristic	Symbol	Max	Unit
Thermal Resistance, Junction–to–Case	$R_{\theta JC}$	1.09	$^\circ\text{C/W}$

Stresses exceeding Maximum Ratings may damage the device. Maximum Ratings are stress ratings only. Functional operation above the Recommended Operating Conditions is not implied. Extended exposure to stresses above the Recommended Operating Conditions may affect device reliability.

1. Indicates JEDEC Registered Data.

*For additional information on our Pb–Free strategy and soldering details, please download the ON Semiconductor Soldering and Mounting Techniques Reference Manual, SOLDERRM/D.



ON Semiconductor®

<http://onsemi.com>

20 AMPERE COMPLEMENTARY SILICON POWER TRANSISTORS 100 VOLTS, 160 WATTS

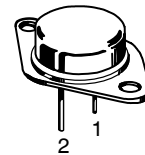
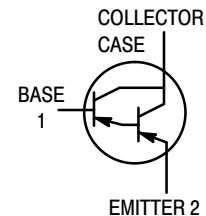

TO–204AA (TO–3)
CASE 1–07
STYLE 1

MARKING DIAGRAM



2N628x = Device Code
 $x = 4, 6 \text{ or } 7$
 G = Pb–Free Package
 A = Location Code
 YY = Year
 WW = Work Week
 MEX = Country of Origin

ORDERING INFORMATION

Device	Package	Shipping
2N6284	TO–3	100 Units/Tray
2N6284G	TO–3 (Pb–Free)	100 Units/Tray
2N6286	TO–3	100 Units/Tray
2N6286G	TO–3 (Pb–Free)	100 Units/Tray
2N6287	TO–3	100 Units/Tray
2N6287G	TO–3 (Pb–Free)	100 Units/Tray

2N6284 (NPN); 2N6286, 2N6287 (PNP)

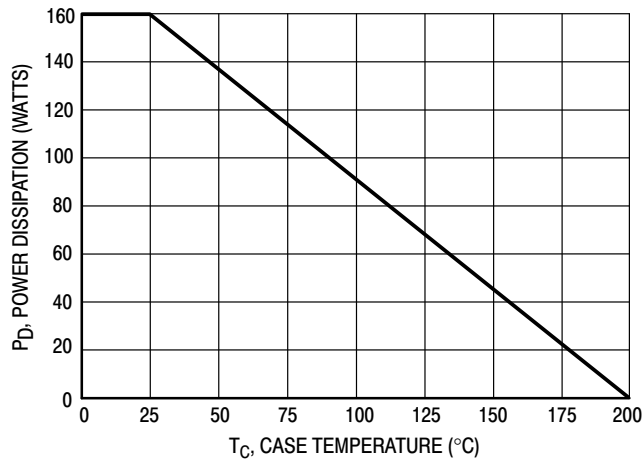

Figure 1. Power Derating

ELECTRICAL CHARACTERISTICS ($T_C = 25^\circ\text{C}$ unless otherwise noted) (Note 2)

Characteristic	Symbol	Min	Max	Unit
OFF CHARACTERISTICS				
Collector–Emitter Sustaining Voltage ($I_C = 0.1 \text{ A dc}$, $I_B = 0$)	$V_{CE(sus)}$	80	–	Vdc
		100	–	
				2N6286 2N6284, 2N6287
Collector Cutoff Current ($V_{CE} = 40 \text{ Vdc}$, $I_B = 0$) ($V_{CE} = 50 \text{ Vdc}$, $I_B = 0$)	I_{CEO}	–	1.0	mAdc
		–	1.0	
Collector Cutoff Current ($V_{CE} = \text{Rated } V_{CB}$, $V_{BE(off)} = 1.5 \text{ Vdc}$) ($V_{CE} = \text{Rated } V_{CB}$, $V_{BE(off)} = 1.5 \text{ Vdc}$, $T_C = 150^\circ\text{C}$)	I_{CEX}	–	0.5	mAdc
		–	5.0	
Emitter Cutoff Current ($V_{BE} = 5.0 \text{ Vdc}$, $I_C = 0$)	I_{EBO}	–	2.0	mAdc

ON CHARACTERISTICS (Note 3)

DC Current Gain ($I_C = 10 \text{ A dc}$, $V_{CE} = 3.0 \text{ Vdc}$) ($I_C = 20 \text{ A dc}$, $V_{CE} = 3.0 \text{ Vdc}$)	h_{FE}	750	18,000	–
		100	–	
Collector–Emitter Saturation Voltage ($I_C = 10 \text{ A dc}$, $I_B = 40 \text{ mAdc}$) ($I_C = 20 \text{ A dc}$, $I_B = 200 \text{ mAdc}$)	$V_{CE(sat)}$	–	2.0	Vdc
		–	3.0	
Base–Emitter On Voltage ($I_C = 10 \text{ A dc}$, $V_{CE} = 3.0 \text{ Vdc}$)	$V_{BE(on)}$	–	2.8	Vdc
Base–Emitter Saturation Voltage ($I_C = 20 \text{ A dc}$, $I_B = 200 \text{ mAdc}$)	$V_{BE(sat)}$	–	4.0	Vdc

DYNAMIC CHARACTERISTICS

Magnitude of Common Emitter Small–Signal Short–Circuit Forward Current Transfer Ratio ($I_C = 10 \text{ A dc}$, $V_{CE} = 3.0 \text{ Vdc}$, $f = 1.0 \text{ MHz}$)	$ h_{fe} $	4.0	–	MHz
Output Capacitance ($V_{CB} = 10 \text{ Vdc}$, $I_E = 0$, $f = 0.1 \text{ MHz}$)	C_{ob}	–	400	pF
		–	600	
				2N6284 2N6286, 2N6287
Small–Signal Current Gain ($I_C = 10 \text{ A dc}$, $V_{CE} = 3.0 \text{ Vdc}$, $f = 1.0 \text{ kHz}$)	h_{fe}	300	–	–

2. Indicates JEDEC Registered Data.

3. Pulse test: Pulse Width = 300 μs , Duty Cycle = 2%

2N6284 (NPN); 2N6286, 2N6287 (PNP)

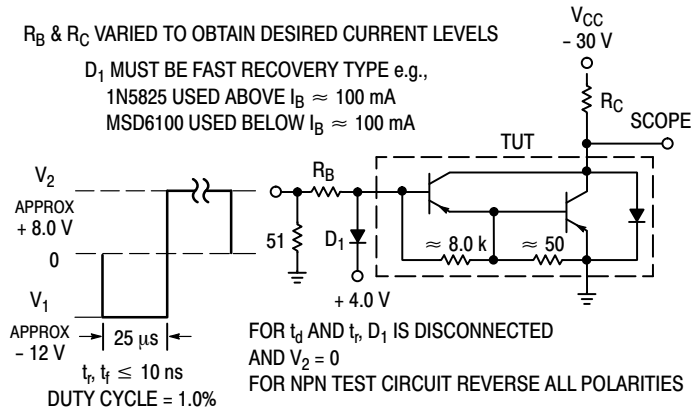

Figure 2. Switching Times Test Circuit

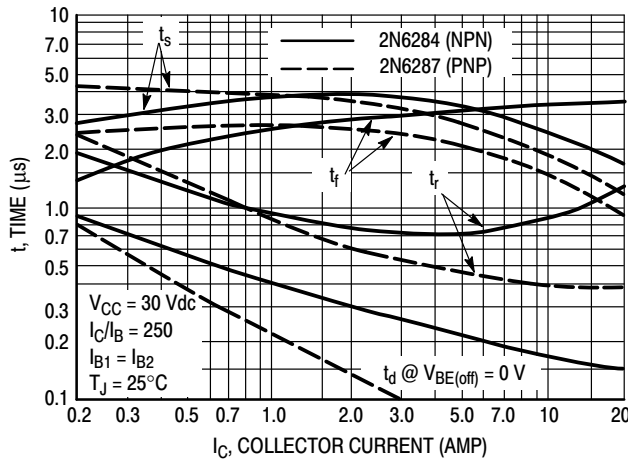

Figure 3. Switching Times

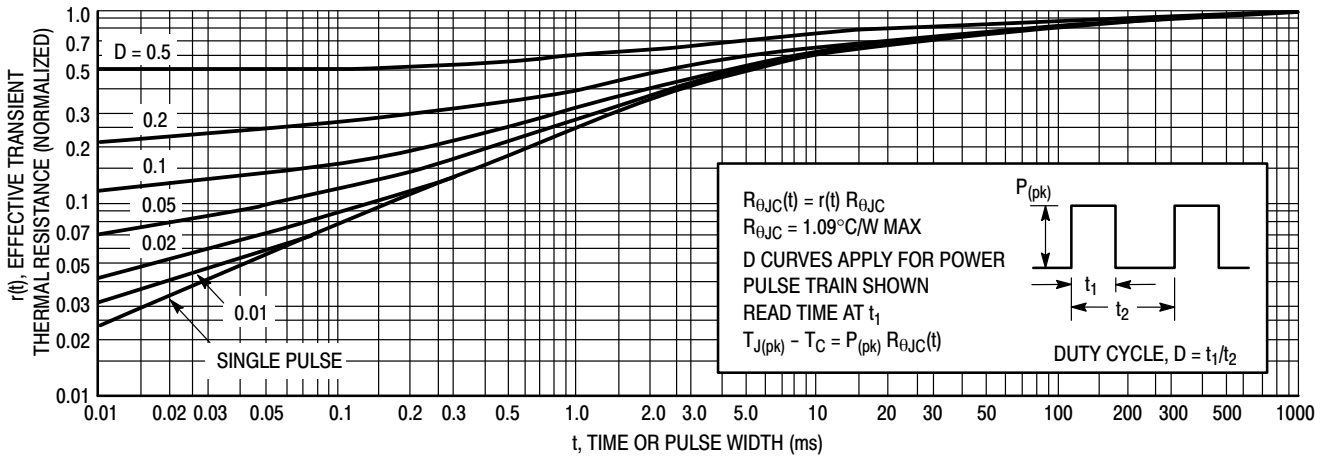

Figure 4. Thermal Response

2N6284 (NPN); 2N6286, 2N6287 (PNP)

ACTIVE-REGION SAFE OPERATING AREA

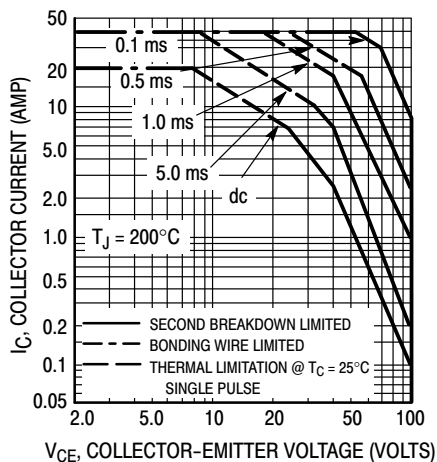

Figure 5. 2N6284, 2N6287

There are two limitations on the power handling ability of a transistor: average junction temperature and second breakdown. Safe operating area curves indicate $I_C - V_{CE}$ limits of the transistor that must be observed for reliable operation; i.e. the transistor must not be subjected to greater dissipation than the curves indicate.

The data of Figure 5 is based on $T_{J(pk)} = 200^\circ\text{C}$; T_C is variable depending on conditions. Second breakdown pulse limits are valid for duty cycles to 10% provided $T_{J(pk)} < 200^\circ\text{C}$. $T_{J(pk)}$ may be calculated from the data in Figure 4. At high case temperatures, thermal limitations will reduce the power that can be handled to values less than the limitations imposed by second breakdown.

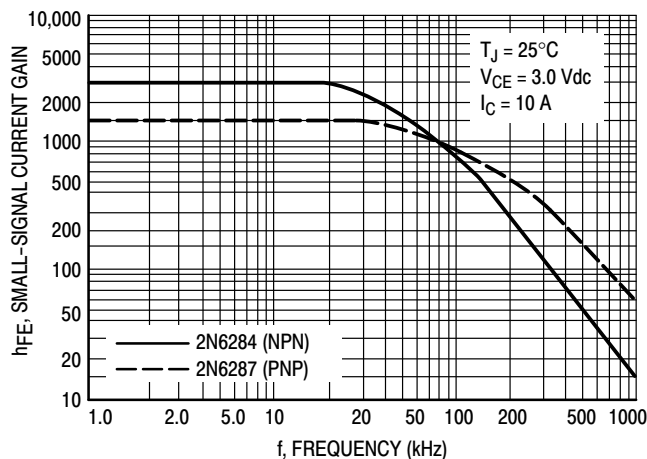

Figure 6. Small-Signal Current Gain

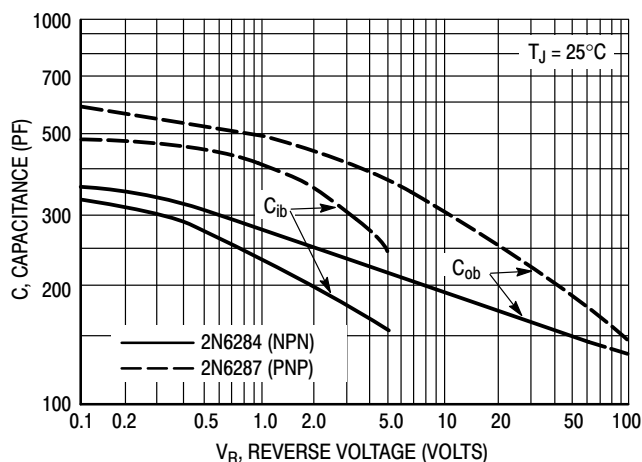

Figure 7. Capacitance

2N6284 (NPN); 2N6286, 2N6287 (PNP)

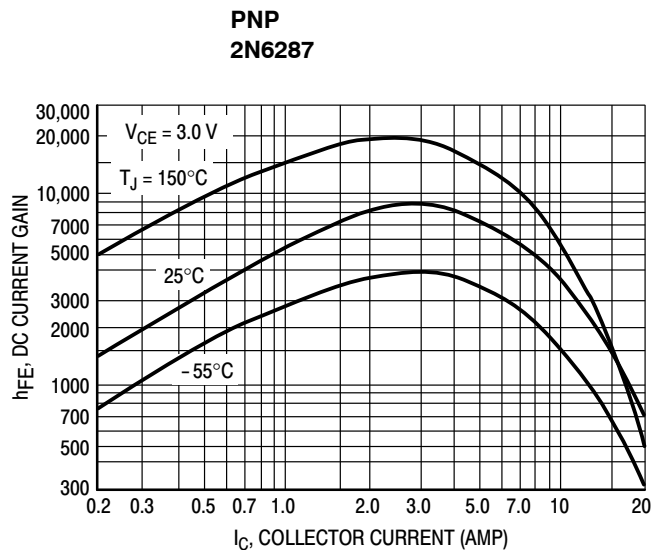
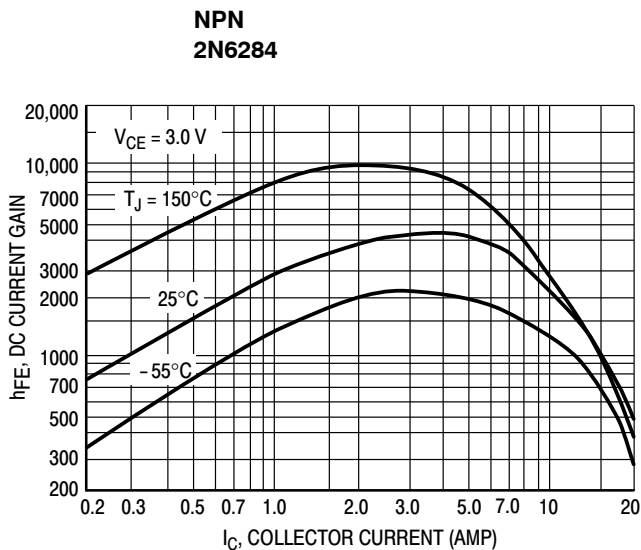

Figure 8. DC Current Gain

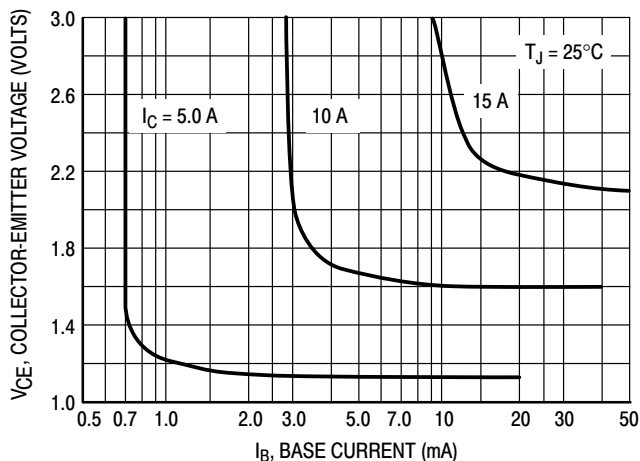
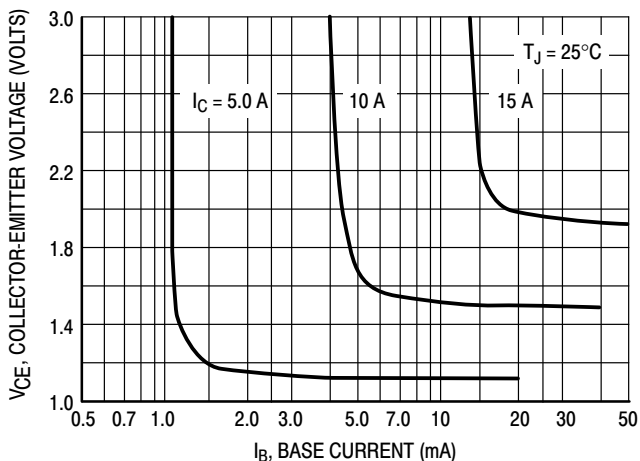

Figure 9. Collector Saturation Region

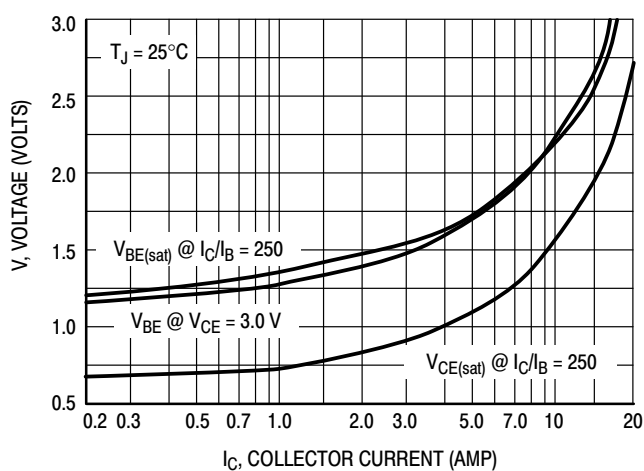
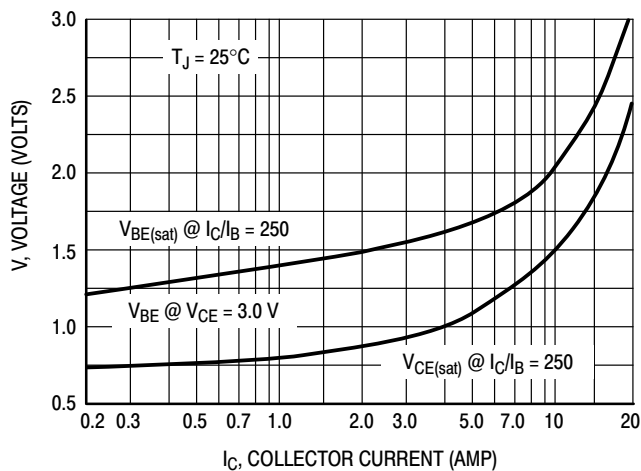

Figure 10. "On" Voltages

2N6284 (NPN); 2N6286, 2N6287 (PNP)

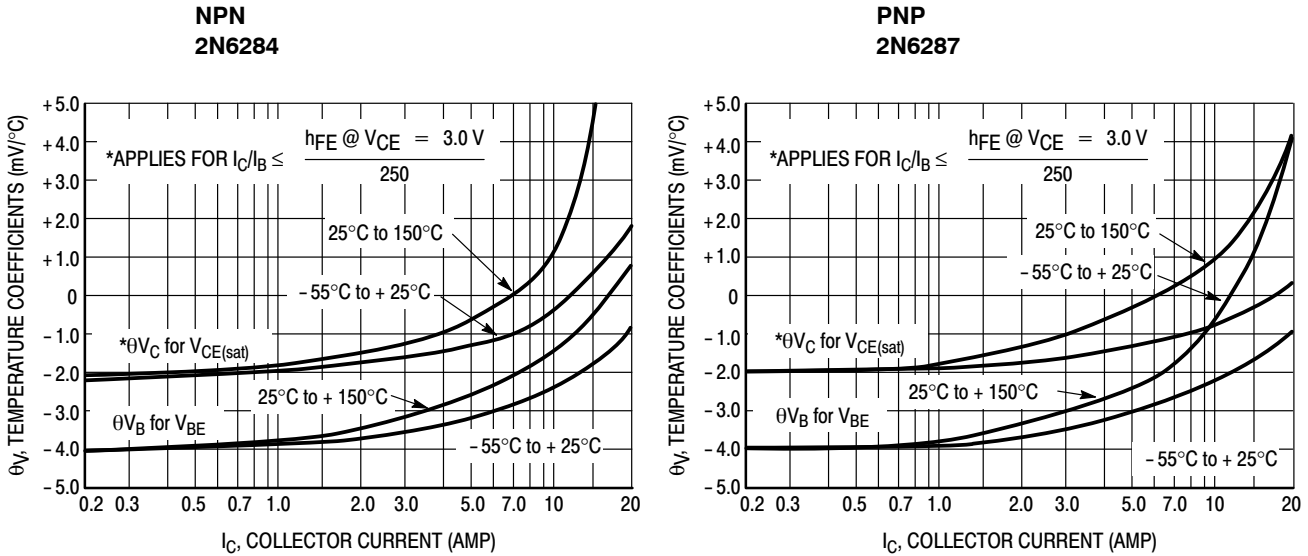

Figure 11. Temperature Coefficients

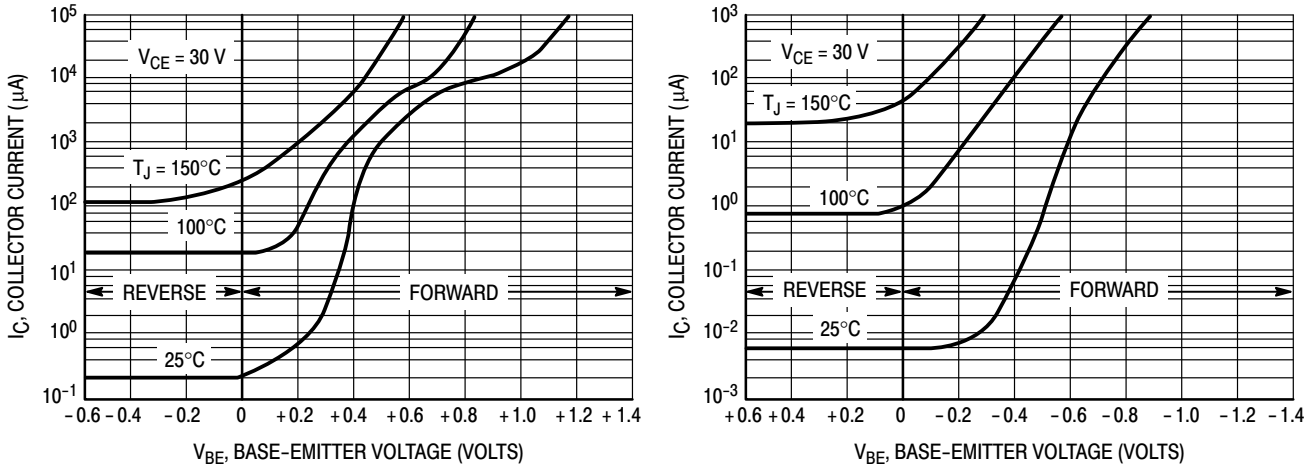

Figure 12. Collector Cut-Off Region

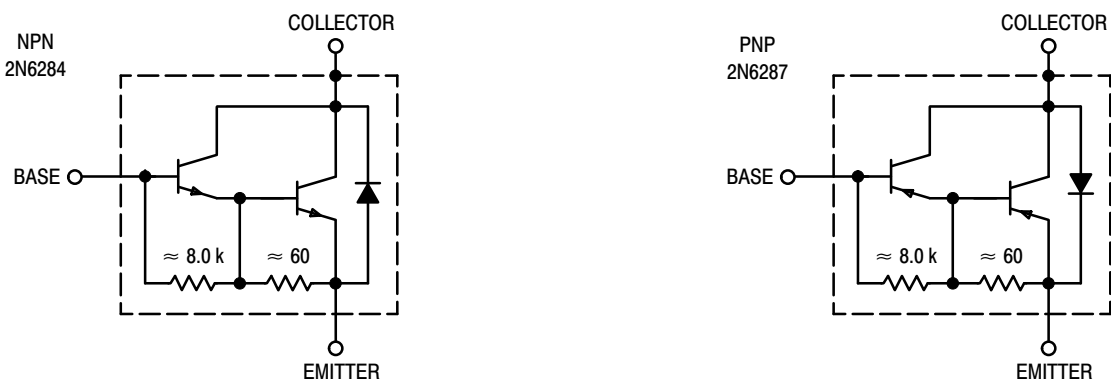

Figure 13. Darlington Schematic

