



RFMD
RF5632

RF5632
RFMD

Features

- 34dB Small Signal Gain (Typ.)
- High Gain; 34dB
- 2.5% EVM WiMAX +28.5dBm, 5.0V
- 2.5% EVM WLAN at 28.5dBm, 5.0V
- Multiple Frequency Ranges
- High Efficiency

Applications

- IEEE 802.11b/g/n WiFi Systems
- 2.4GHz ISM Band Applications
- Commercial and Consumer Systems
- WiBro 2.3GHz to 2.4GHz Band Applications
- WiFi 2.4GHz to 2.5GHz Band Applications
- WiMAX 2.5GHz to 2.7GHz Band Applications

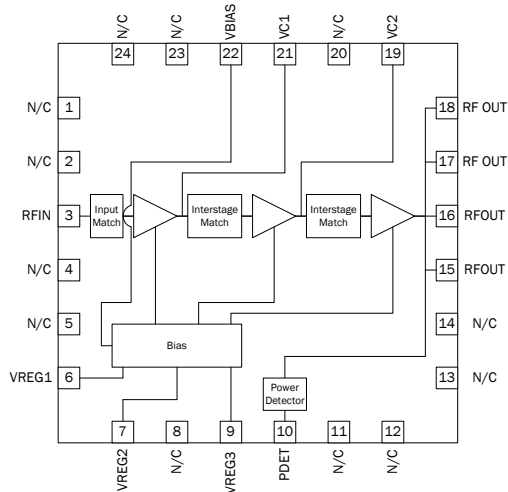

Functional Block Diagram

Product Description

The RF5632 is a linear power amplifier IC designed specifically for WiMAX or WLAN final or driver stage applications. The device is manufactured on an advanced InGaP Heterojunction Bipolar Transistor (HBT) process, and is provided in a leadless chip carrier with a backside ground. The RF5632 is designed to maintain linearity over a wide range of temperatures and power outputs. The external match offers tunability for output power over multiple bands. RF5632 features internal input and interstage match, Low Gain mode, and output power detector.

Optimum Technology Matching® Applied

- | | | | |
|---|--------------------------------------|-------------------------------------|-----------------------------------|
| <input type="checkbox"/> GaAs HBT | <input type="checkbox"/> SiGe BiCMOS | <input type="checkbox"/> GaAs pHEMT | <input type="checkbox"/> GaN HEMT |
| <input type="checkbox"/> GaAs MESFET | <input type="checkbox"/> Si BiCMOS | <input type="checkbox"/> Si CMOS | <input type="checkbox"/> RF MEMS |
| <input checked="" type="checkbox"/> InGaP HBT | <input type="checkbox"/> SiGe HBT | <input type="checkbox"/> Si BJT | |

Absolute Maximum Ratings

Parameter	Rating	Unit
Supply Voltage, RF Applied	-0.5 to +5.25	V _{DC}
Supply Voltage, no RF Applied	-0.5 to +6.0V	V _{DC}
DC Supply Current (RMS)	1200	mA
Input RF Power with 50Ω Output Load	+10	dBm
Input RF Power with non-50Ω Output Load	+5	dBm
Operating Ambient Temperature	-40 to +85	°C
Storage Temperature	-40 to +150	°C
Moisture Sensitivity	MSL2	



Caution! ESD sensitive device.

Exceeding any one or a combination of the Absolute Maximum Rating conditions may cause permanent damage to the device. Extended application of Absolute Maximum Rating conditions to the device may reduce device reliability. Specified typical performance or functional operation of the device under Absolute Maximum Rating conditions is not implied.

RoHS status based on EUDirective2002/95/EC (at time of this document revision).

The information in this publication is believed to be accurate and reliable. However, no responsibility is assumed by RF Micro Devices, Inc. ("RFMD") for its use, nor for any infringement of patents, or other rights of third parties, resulting from its use. No license is granted by implication or otherwise under any patent or patent rights of RFMD. RFMD reserves the right to change component circuitry, recommended application circuitry and specifications at any time without prior notice.

Parameter	Specification			Unit	Condition
	Min.	Typ.	Max.		
WLAN IEEE802.11b/g/n					Nominal Condition T=25 °C, V _{CC} =5.0V, V _{REG 1, 2, and 3} =5.0V, Frequency=2400MHz to 2500MHz, Duty Cycle 10% to 100% unless otherwise noted.
Frequency Range	2400		2500	MHz	
Compliance					IEEE802.11g/n and IEEE802.11b
Output Power	28	28.5		dBm	With a standard IEEE802.11g waveform (54Mbps), V _{CC} =5.0V
EVM		2.5	3	%	54Mbps 11g Modulation: RMS, Mean; at P _{OUT} - 28dBm; Duty Cycle 100%
Gain	32	34	36		At rated P _{OUT}
Low Gain Mode - Gain Reduction		26		dB	Drop in gain versus high gain mode, by setting V _{REG2} =0.0V
IEEE802.11b P _{OUT}	30	30.5		dBm	
ACP1			-33	dBc	Using 11b waveform at 1Mbps
ACP2			-53	dBc	Using 11b waveform at 1Mbps
Input Return Loss		-12	-8	dB	
Power Detect Voltage	0.2		2.2	V	P _{OUT} =0 to 30dBm. Usable power detector range is P _{OUT} =0 to 34dBm.
Noise Figure		5		dB	
Power Supply					
Operating Voltage		5	5.25	V	At V _{CC1} , V _{CC2} , V _{CC3} , and V _{BIAS}
V _{REG1} , V _{REG2} , V _{REG3} Input Voltage	4.75	5	5.25	V _{DC}	Operating
Current					
Operating		800	1000	mA	At P _{OUT} =28dBm and V _{CC} =5.0V
Quiescent	400	500	600	mA	V _{CC} =5.0V; V _{REG} =5.0V
I _{REG}		8	10	mA	V _{CC} =5.0V; V _{REG} =5.0V

Parameter	Specification			Unit	Condition
	Min.	Typ.	Max.		
WiMAX IEEE802.16e					Nominal Condition T=25 °C, V _{CC} =5.0V, V _{REG} 1, 2, and 3=5.0V, Frequency=2500MHz to 2700MHz. Duty cycle 37% duty cycle unless otherwise noted.
Frequency Range	2500		2700	MHz	
Compliance					IEEE802.16e
Output Power	28	28.5		dBm	With a standard IEEE802.116e waveform BW=10MHz, V _{CC} =5.0V
EVM		2.5	3.25	%	RMS, Mean; at P _{OUT} =28dBm
EVM		2.5	3.25	%	RMS, Mean; at P _{OUT} =27 dBm over temperature
Gain	31.5	33.5	35.5		At nominal condition and V _{CC} =5.0V
Gain Flatness			3	dB	Peak-to-peak over 200MHz bandwidth
Low Gain Mode - Gain Reduction		25		dB	Drop in gain versus high gain mode, by setting V _{REG2} =0.0V
Input Return Loss		-12	-7	dB	
Power Detect Voltage	0.2		2.2	V	P _{OUT} =0 to 30dBm. Usable power detector range is P _{OUT} =0 to 34dBm.
Noise Figure		4.5		dB	
Power Supply					
Operating Voltage		5	5.25	V	
V _{REG1} , V _{REG2} , V _{REG3} Input Voltage	4.75	5	5.25	V _{DC}	Operating
Current					
Operating		875	1000	mA	At P _{OUT} =28dBm and V _{CC} =5.0V
Quiescent	375	450	525	mA	V _{CC} =5.0V; V _{REG} =5.0V
I _{REG}		8	10	mA	V _{CC} =5.0V; V _{REG} =5.0V
Specifications - WL, WM, WB Tunes					
Shutdown		0.2	0.6	μA	V _{CC} =5V, V _{REG} =0V, T=25 °C
			6	μA	V _{CC} =5V, V _{REG} =0V, T=85 °C
Turn-on Time From Setting V _{REG}			400	nsec	Output stable to within 90% of final gain
ESD Withstand Capability	500			V	HBM, all pin combinations
Stability	0		34	dBm	
Stable into Output VSWR			4:1		No spurs above -47dBm
Thermal Resistance		21		°C/W	Junction to evaluation board. Maintain board temp ≤ 85 °C
Duty cycle		75		%	Max recommended duty cycle is 75% for long term reliable operation at max board temperature=85 °C. 100% duty cycles can be used if the board temperature is not above 65 °C

Parameter	Specification			Unit	Condition
	Min.	Typ.	Max.		
WiBro					Nominal Condition T=25 °C, V _{CC} =5.0V, V _{REG1, 2, and 3} =5.0V, Frequency=2300MHz to 2400MHz. Duty cycle 37% duty cycle unless otherwise noted.
Frequency Range	2300		2400	MHz	
Compliance					IEEE802.16e
Output Power	28	28.5		dBm	With a standard IEEE802.116e waveform BW=10MHz, V _{CC} =5.0V
EVM		2.75	3.5	%	RMS, Mean; at P _{OUT} =28dBm
Gain	33	35	37.5		At rated P _{OUT}
Low Gain Mode - Gain Reduction		28		dB	Drop in gain versus high gain mode, by setting V _{REG2} =0.0V
Input Return Loss		-20	-12	dB	
Power Detect Voltage	0.2		2.2	V	P _{OUT} =0 to 30dBm. Usable power detector range is P _{OUT} =0 to 34dBm.
Noise Figure		5		dB	
Power Supply					
Operating Voltage		5	5.25	V	
V _{REG1, VREG2, VREG3} Input Voltage	4.75	5	5.25	V _{DC}	Operating
Current					
Operating		800	950	mA	At P _{OUT} =28dBm and V _{CC} =5.0V
Quiescent	400	500	600	mA	V _{CC} =5.0V; V _{REG} =5.0V
I _{REG}		8	10	mA	V _{CC} =5.0V; V _{REG} =5.0V

Pin	Function	Description
3	RFIN	RF input. This pin is matched to 50Ω and is DC-blocked internally.
6	VREG1	First stage input bias voltage. This pin requires a regulated supply to maintain nominal bias current.
7	VREG2	Second stage input bias voltage. This pin requires a regulated supply to maintain nominal bias current.
9	VREG3	Third stage input bias voltage. This pin requires a regulated supply to maintain nominal bias current.
10	PDET	Power detector provides an output voltage proportional to the RF level VCC3/RF OUT.
15-18	VCC3/RFOUT	RF output and bias for the third stage. Output is externally matched to 50Ω and needs DC block.
19	VCC2	Second stage supply voltage.
21	VCC1	First stage supply voltage.
22	VBIAS	Supply voltage for the bias reference and control circuits. May be connected with VCC1, VCC2, VCC3 as long as appropriate isolation is provided.
1, 2, 4, 5, 8, 11, 12, 13, 14, 20, 23, 24	N/C	No internal connection. May be connected to ground.
Pkg Base	GND	Ground connection. The back side of the package should be connected to the ground plane through as short a connection as possible, e.g., PCB vias under the device.

Package Drawing

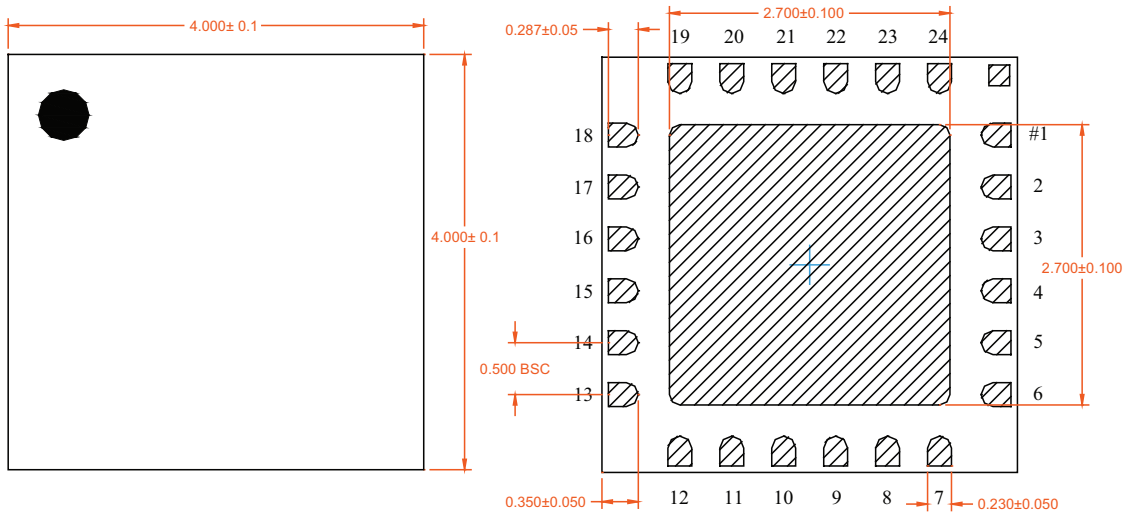

A = 0.230 x 0.287 (mm)
 B = 0.287 x 0.230 (mm)
 C = 2.700 x 2.700 (mm)

A = 0.380 x 0.437 (mm)
 B = 0.437 x 0.380 (mm)
 C = 2.850 x 2.850 (mm)

A = 0.207 x 0.258 (mm)
 B = 0.258 x 0.207 (mm)
 C = 1.125 x 1.125 (mm)

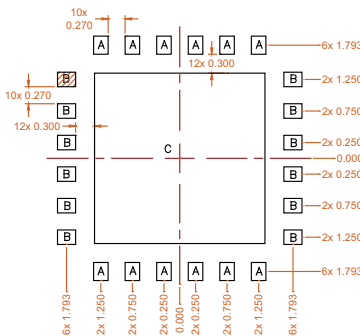

PCB METAL LAND PATTERN

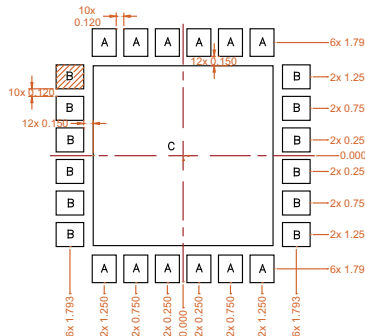

PCB SOLDER MASK PATTERN

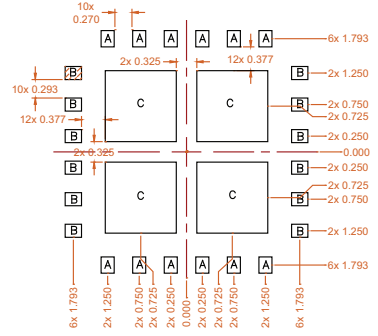

PCB STENCIL PATTERN

Thermal vias for center slug "C" should be incorporated into the PCB design. The number and size of thermal vias will depend on the application, the power dissipation, and the electrical requirements. Example of the number and size of vias can be found on the RFMD evaluation board layout.

Evaluation Board Schematic - WLAN 2.4GHz to 2.5GHz

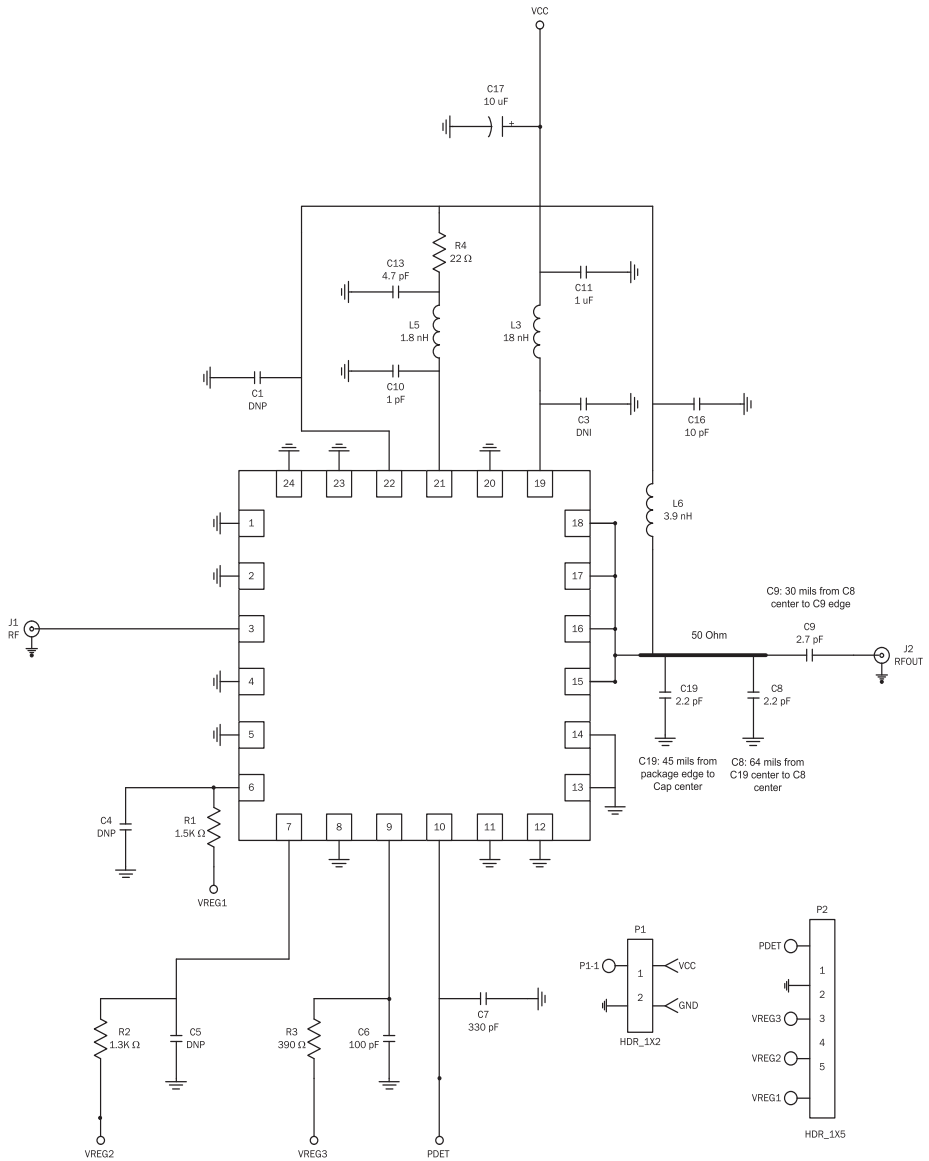

Evaluation Board Schematic - WiMAX 2.5GHz to 2.7 GHz

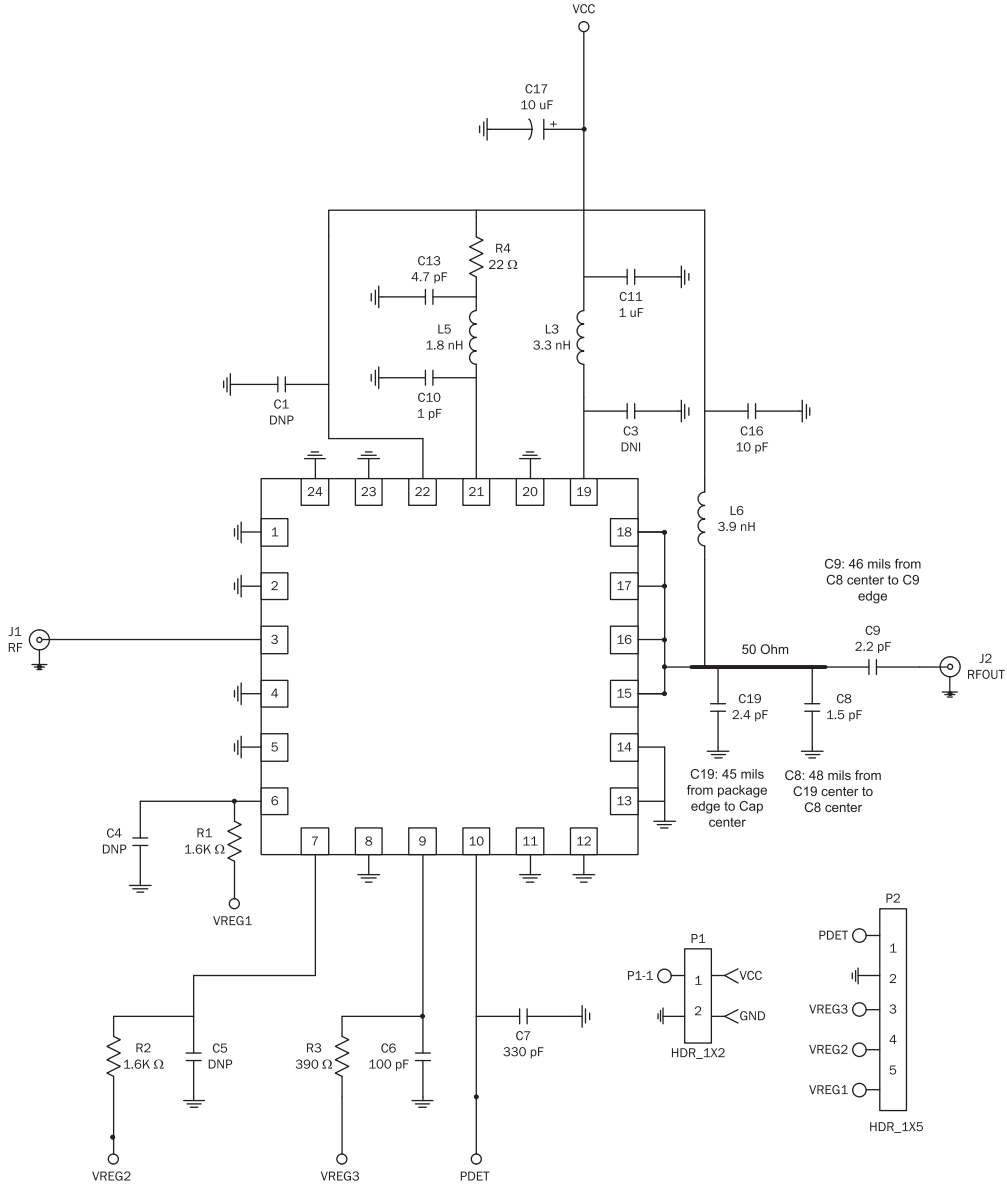

Evaluation Board Schematic - WiBro 2.3GHz to 2.4GHz

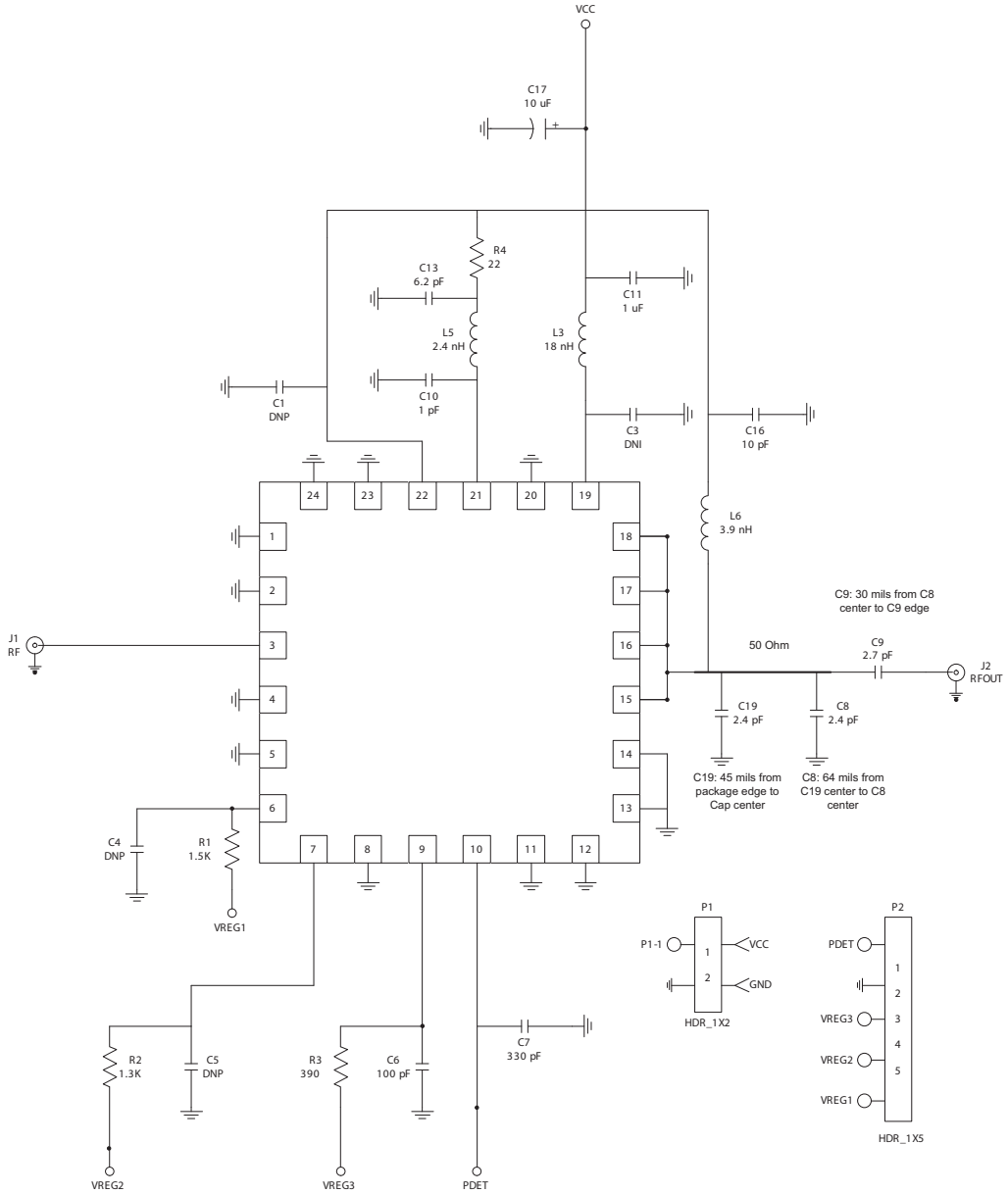

Evaluation Board Layout

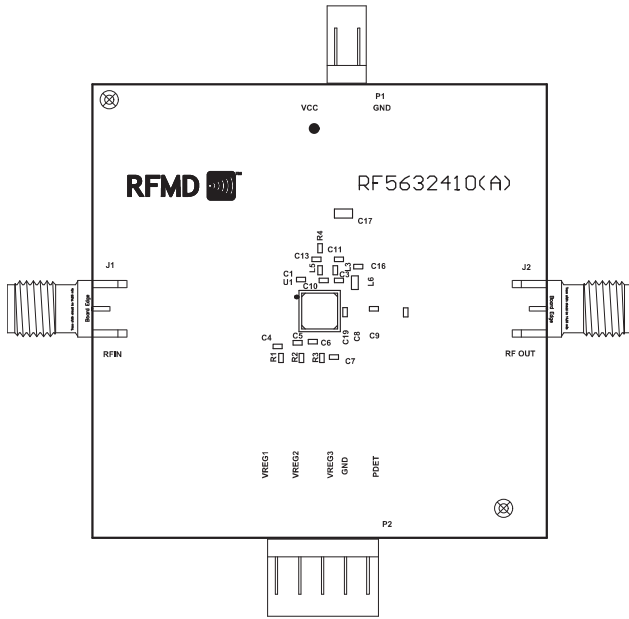

Assembly

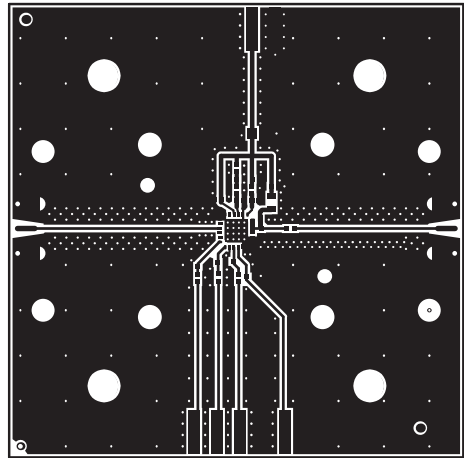

Top

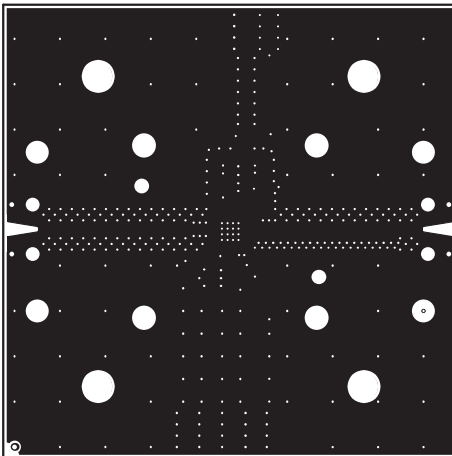

In1

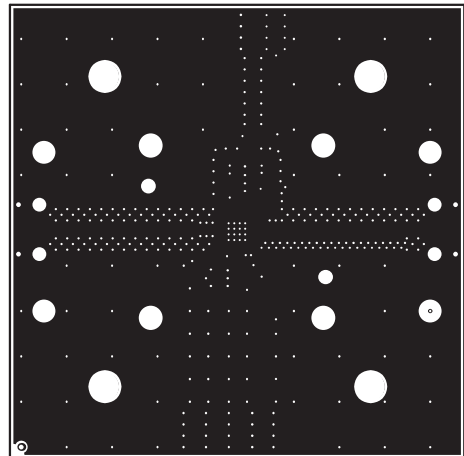

In2

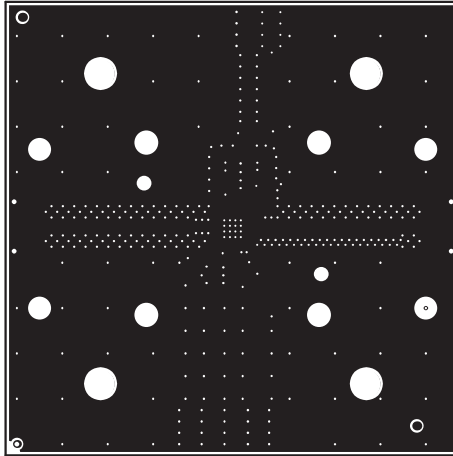

Back

WLAN Performance Plots

EVM(%) vs. Pout(dBm)
-40° C
Vcc=5Vdc Vreg=5Vdc

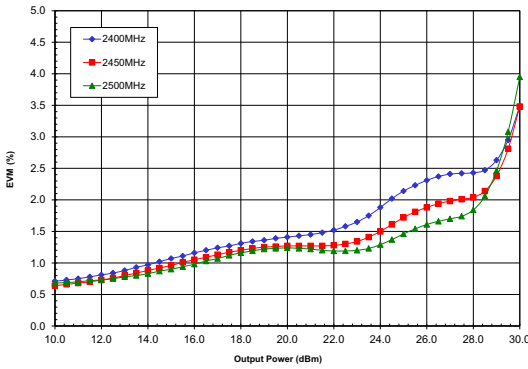

EVM(%) vs. Pout(dBm)
25° C
Vcc=5Vdc Vreg=5Vdc

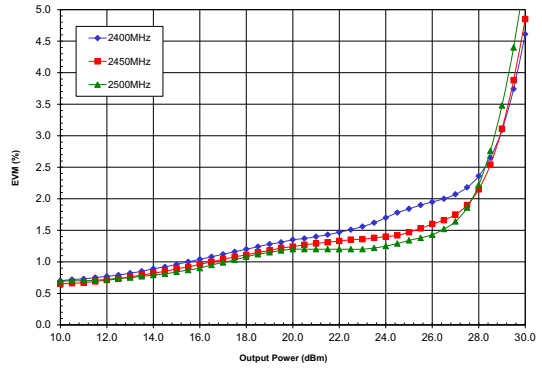

EVM(%) vs. Pout(dBm)
85° C
Vcc=5Vdc Vreg=5Vdc

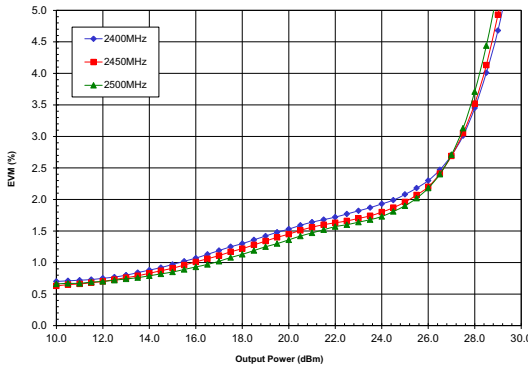

Icc(A) vs. Pout(dBm)
-40° C
Vcc=5Vdc Vreg=5Vdc

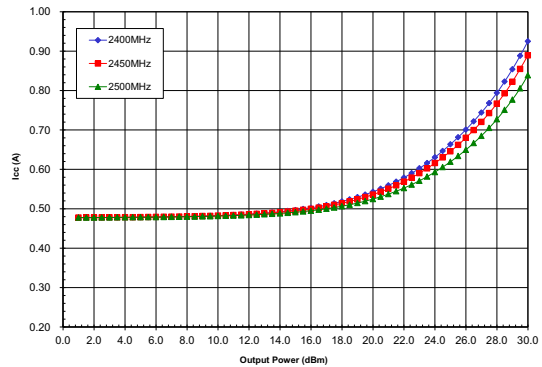

Icc(A) vs. Pout(dBm)
25° C
Vcc=5Vdc Vreg=5Vdc

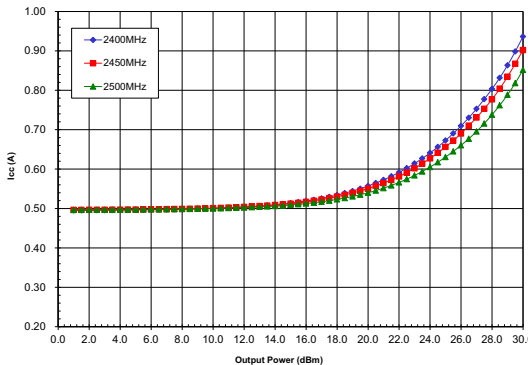

Icc(A) vs. Pout(dBm)
85° C
Vcc=5Vdc Vreg=5Vdc

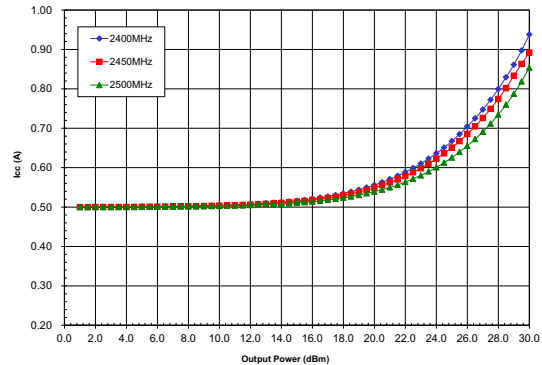

Gain(dB) vs. Pout(dBm)
-40° C
Vcc=5Vdc Vreg=5Vdc

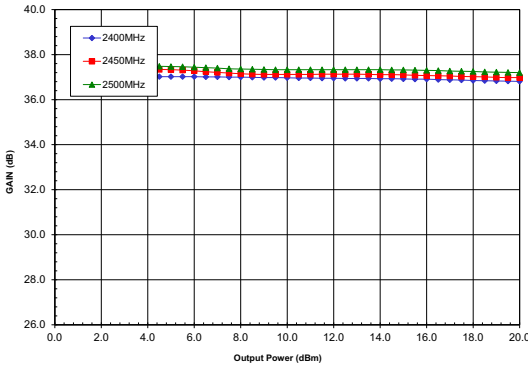

Gain(dB) vs. Pout(dBm)
25° C
Vcc=5Vdc Vreg=5Vdc

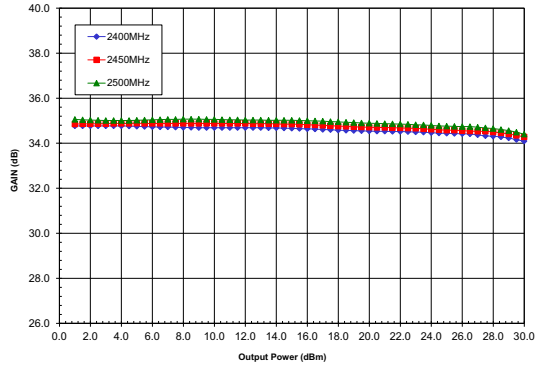

Gain(dB) vs. Pout(dBm)
85° C
Vcc=5Vdc Vreg=5Vdc

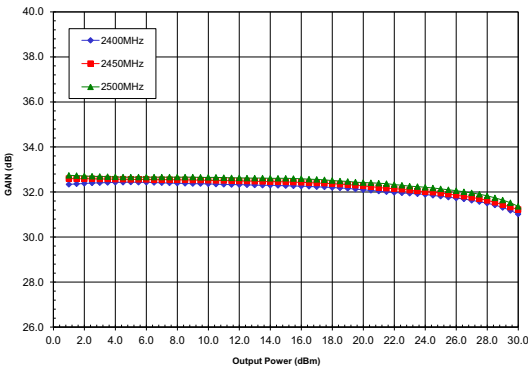

Power Detect (V) vs. Pout(dBm)
-40° C
Vcc=5Vdc Vreg=5Vdc

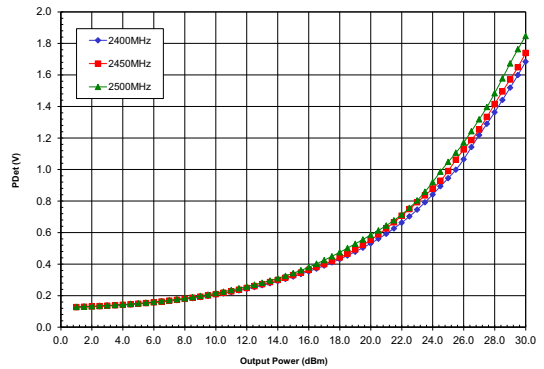

Power Detect (V) vs. Pout(dBm)
25° C
Vcc=5Vdc Vreg=5Vdc

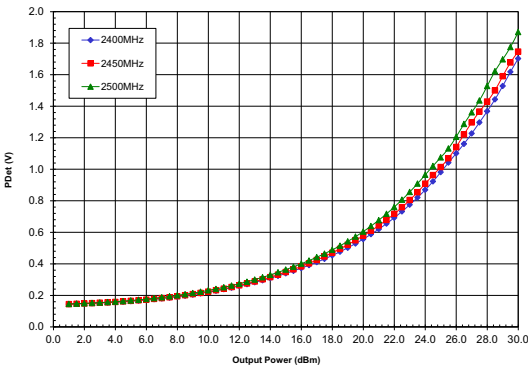

Power Detect (V) vs. Pout(dBm)
85° C
Vcc=5Vdc Vreg=5Vdc

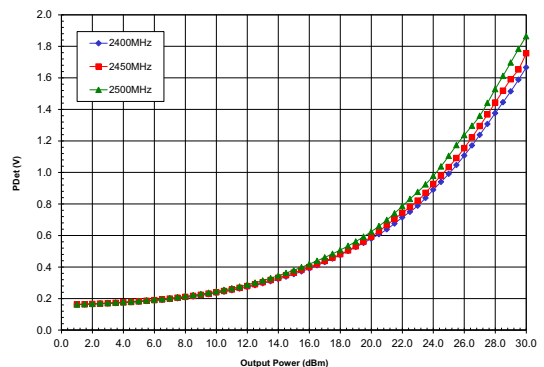

WiMax Performance Plots

EVM(%) vs. Pout(dBm)
- 40° C
Vcc=5Vdc Vreg=5Vdc

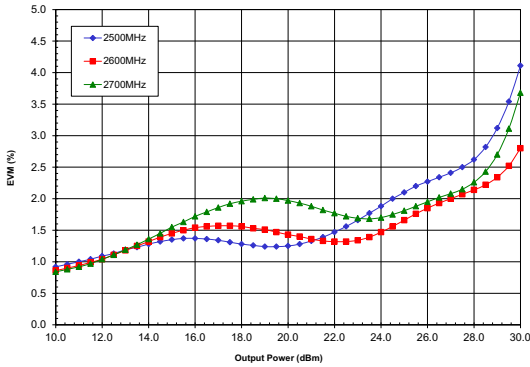

EVM(%) vs. Pout(dBm)
25° C
Vcc=5Vdc Vreg=5Vdc

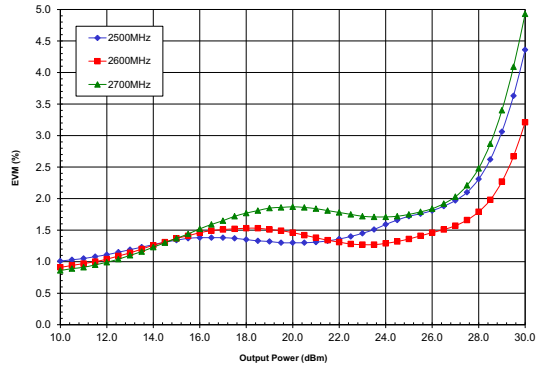

EVM(%) vs. Pout(dBm)
85° C
Vcc=5Vdc Vreg=5Vdc

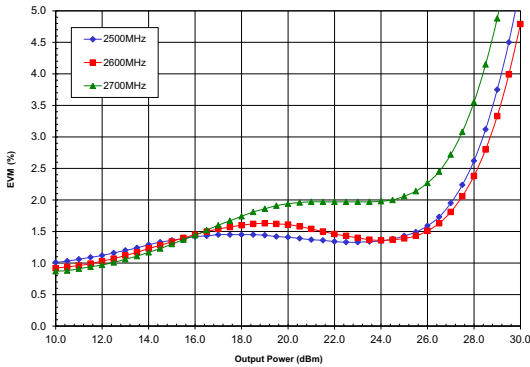

Icc(A) vs. Pout(dBm)
- 40° C
Vcc=5Vdc Vreg=5Vdc

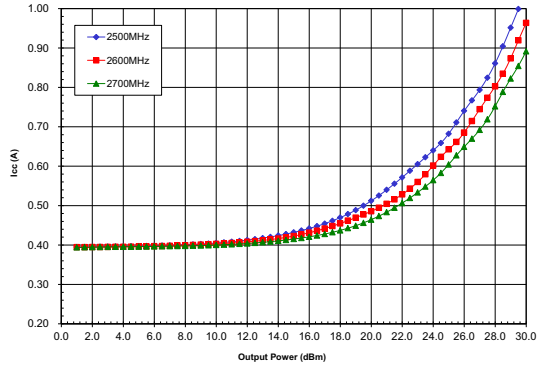

Icc(A) vs. Pout(dBm)
25° C
Vcc=5Vdc Vreg=5Vdc

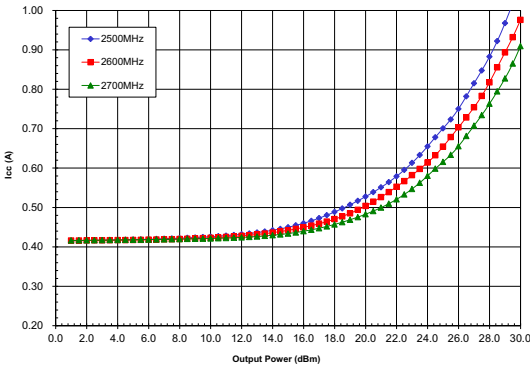

Icc(A) vs. Pout(dBm)
85° C
Vcc=5Vdc Vreg=5Vdc

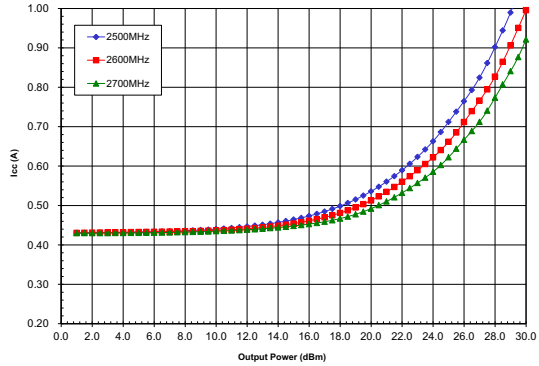

Gain(dB) vs. Pout(dBm)
40° C
Vcc=5Vdc Vreg=5Vdc

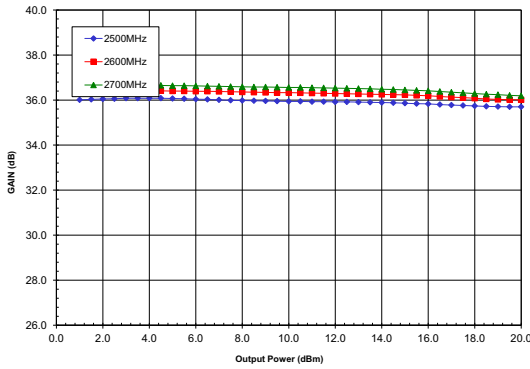

Gain(dB) vs. Pout(dBm)
25° C
Vcc=5Vdc Vreg=5Vdc

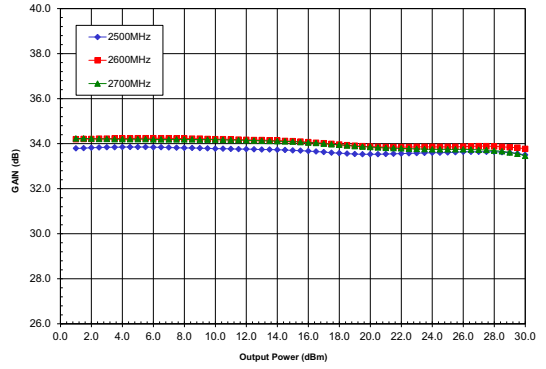

Gain(dB) vs. Pout(dBm)
85° C
Vcc=5Vdc Vreg=5Vdc

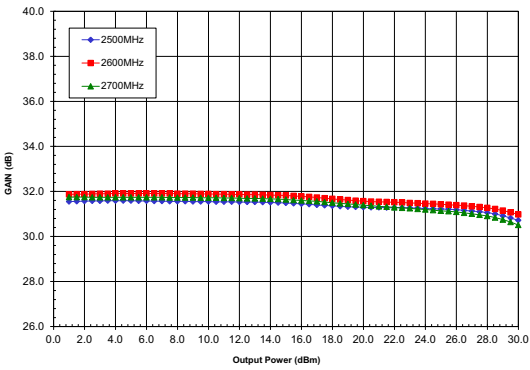

Power Detect (V) vs. Pout(dBm)
40° C
Vcc=5Vdc Vreg=5Vdc

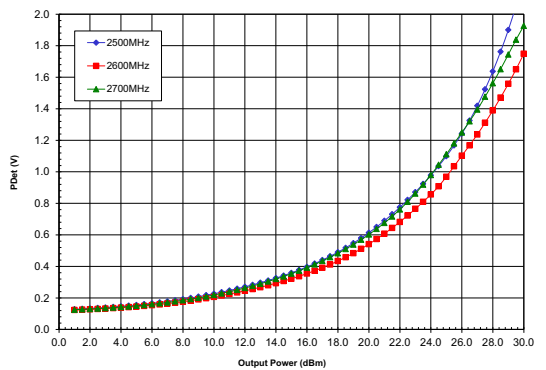

Power Detect (V) vs. Pout(dBm)
25° C
Vcc=5Vdc Vreg=5Vdc

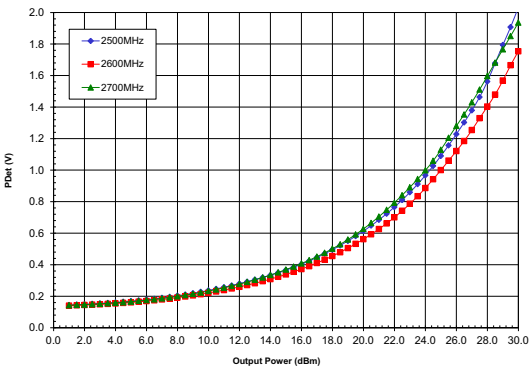

Power Detect (V) vs. Pout(dBm)
85° C
Vcc=5Vdc Vreg=5Vdc

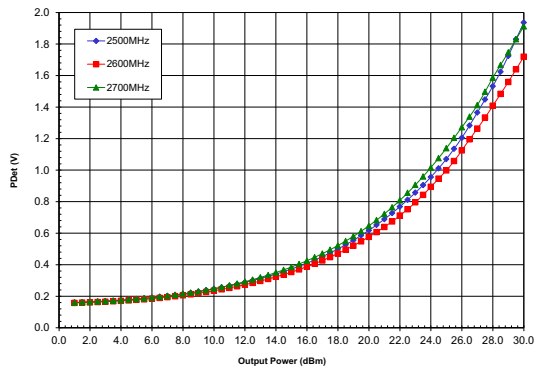

WiBro Performance Plots

EVM(%) vs. Pout(dBm)
-40° C
Vcc=5Vdc Vreg=5Vdc

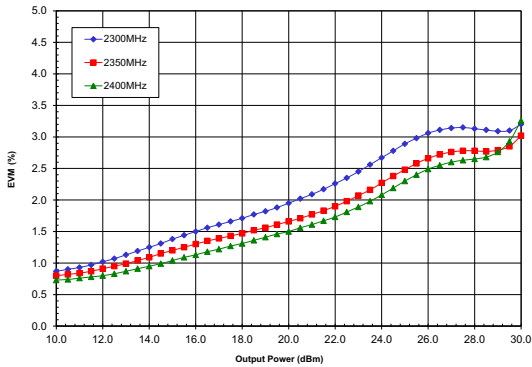

EVM(%) vs. Pout(dBm)
25° C
Vcc=5Vdc Vreg=5Vdc

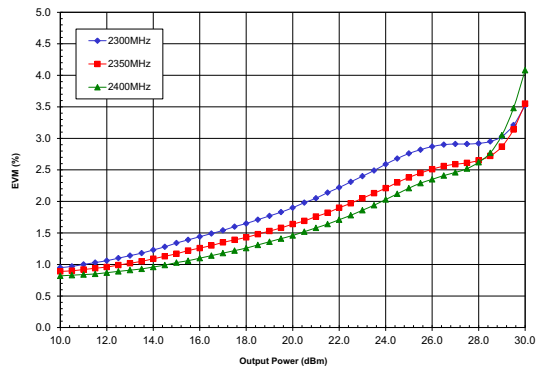

EVM(%) vs. Pout(dBm)
85° C
Vcc=5Vdc Vreg=5Vdc

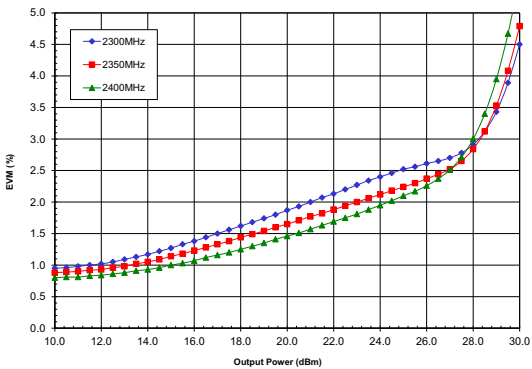

Icc(A) vs. Pout(dBm)
-40° C
Vcc=5Vdc Vreg=5Vdc

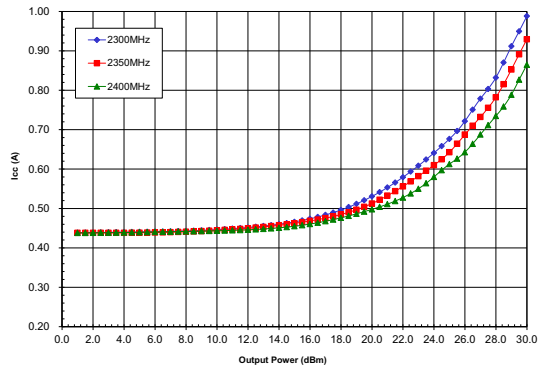

Icc(A) vs. Pout(dBm)
25° C
Vcc=5Vdc Vreg=5Vdc

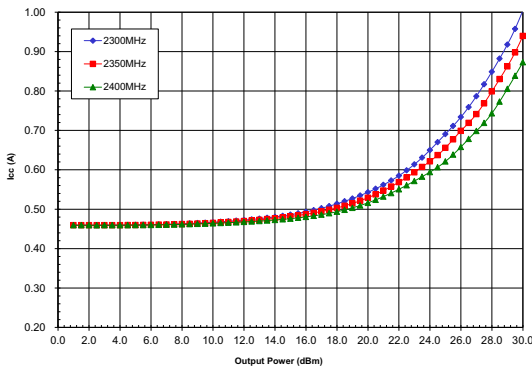

Icc(A) vs. Pout(dBm)
85° C
Vcc=5Vdc Vreg=5Vdc

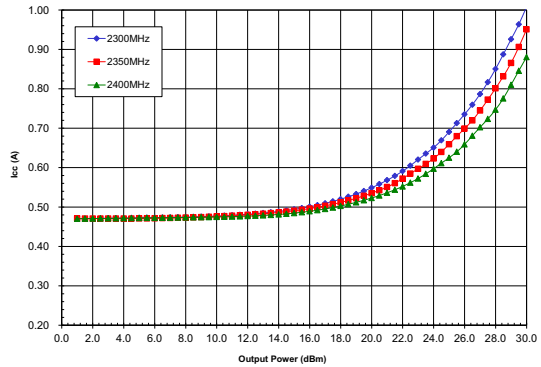

Gain(dB) vs. Pout(dBm)
40° C
Vcc=5Vdc Vreg=5Vdc

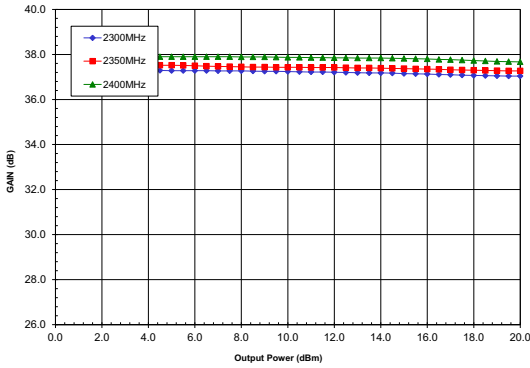

Gain(dB) vs. Pout(dBm)
25° C
Vcc=5Vdc Vreg=5Vdc

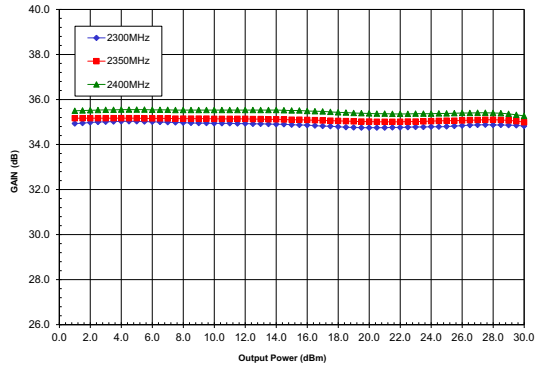

Gain(dB) vs. Pout(dBm)
85° C
Vcc=5Vdc Vreg=5Vdc

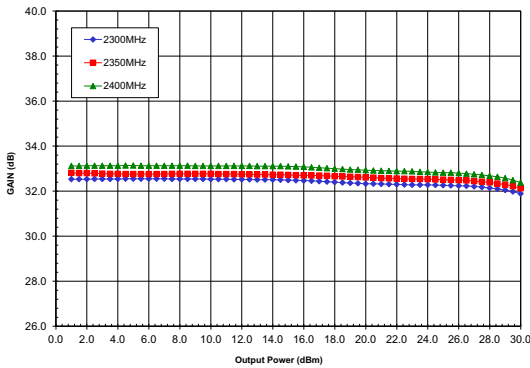

Power Detect (V) vs. Pout(dBm)
-40° C
Vcc=5Vdc Vreg=5Vdc

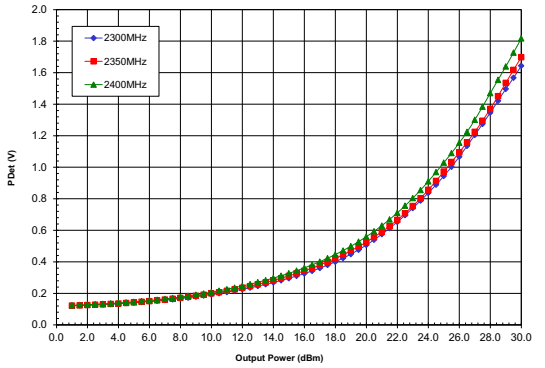

Power Detect (V) vs. Pout(dBm)
25° C
Vcc=5Vdc Vreg=5Vdc

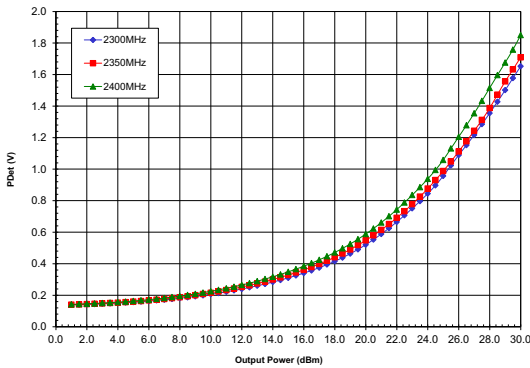

Power Detect (V) vs. Pout(dBm)
85° C
Vcc=5Vdc Vreg=5Vdc

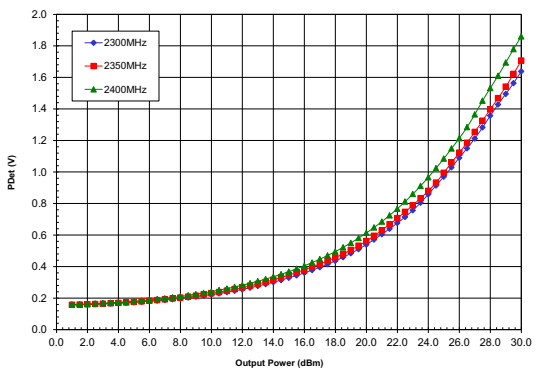

Ordering Information

Part Number	Description
RF5632	Standard 25 piece bag
RF5632SB	Standard 5 piece bag
RF5632SR	Standard 100 piece bag
RF5632TR13	Standard 2500 piece reel
RF5632PCK-410	Fully assembled RF5632 PCBA and 5 loose pcs for WiBro tune 2.3GHz to 2.4GHz
RF5632PCK-411	Fully assembled RF5632 PCBA and 5 loose pcs for WLAN tune 2.4GHz to 2.5GHz
RF5632PCK-412	Fully assembled RF5632 PCBA and 5 loose pcs for WiMAX tune 2.5GHz to 2.7GHz