

Package Style: Module 6.63mmx5.24mmx1.0mm



Features

- 8kV Robust ESD Protection at Antenna Port
- Enhanced Performance Transmit Module
- No External Routing
- High Efficiency at rated P_{OUT}
V_{BATT} = 3.5V
GSM900 41%
DCS1800 38%
- Low RX Insertion Loss
- Symmetrical RX Ports
- 0dBm to 6dBm Drive Level, >50dB of Dynamic Range
- Integrated Power Flattening Circuit

Applications

- 3V Dual-Band GSM/GPRS Handsets
- GSM900/DCS1800 Products
- GPRS Class 12 Compliant
- Portable Battery-Powered Equipment

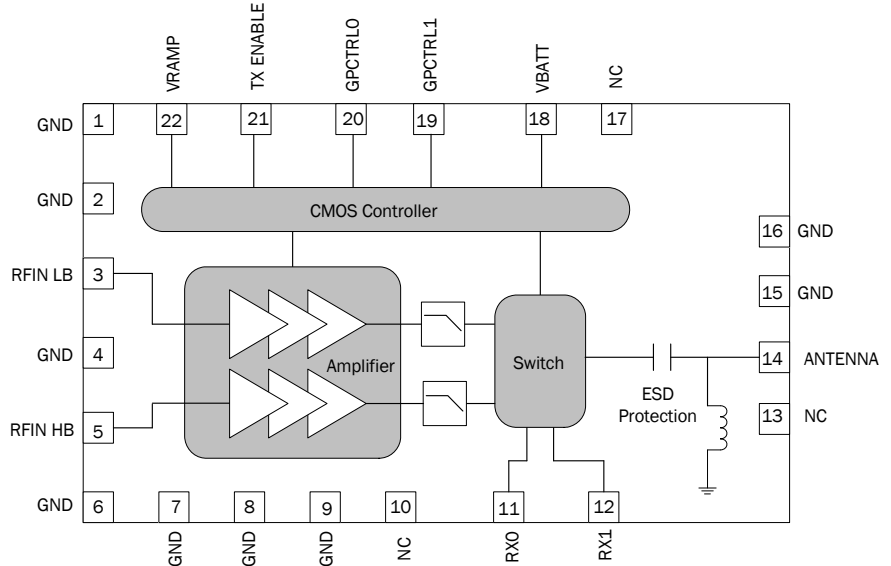

Functional Block Diagram

Product Description

The RF7166 is a dual band (EGSM900/DCS1800) GSM/GPRS Class 12 compliant transmit module with two symmetrical receive ports. This transmit module builds upon RFMD’s leading power amplifier with PowerStar® integrated power control technology, pHEMT switch technology, and integrated transmit filtering for best-in-class harmonic performance. The results are high performance, a reduced solution size, and ease of implementation. The device is designed for use as the final portion of the transmitter section in a GSM900/DCS1800 handset and eliminates the need for PA-to-antenna switch module matching network. The device provides 50Ω matched input and output ports requiring no external matching components.

The RF7166 features RFMD’s latest integrated power-flattening circuit, which significantly reduces current and power variation into load mismatch. The RF7166 also integrates an ESD filter to provide excellent ESD protection at the antenna port. The RF7166 is designed to provide maximum efficiency at rated P_{OUT}.

RF7166	Dual-Band GSM900/DCS1800 Transmit Module
RF7166SB	Transmit Module 5-Piece Sample Pack
RF7166PCBA-41X	Fully Assembled Evaluation Board

Optimum Technology Matching® Applied

- | | | | |
|--|--------------------------------------|--|-----------------------------------|
| <input checked="" type="checkbox"/> GaAs HBT | <input type="checkbox"/> SiGe BiCMOS | <input checked="" type="checkbox"/> GaAs pHEMT | <input type="checkbox"/> GaN HEMT |
| <input type="checkbox"/> GaAs MESFET | <input type="checkbox"/> Si BiCMOS | <input checked="" type="checkbox"/> Si CMOS | <input type="checkbox"/> RF MEMS |
| <input type="checkbox"/> InGaP HBT | <input type="checkbox"/> SiGe HBT | <input type="checkbox"/> Si BJT | <input type="checkbox"/> LD MOS |

RF MICRO DEVICES®, RFMD®, Optimum Technology Matching®, Enabling Wireless Connectivity™, PowerStar®, POLARIS™ TOTAL RADIO™ and UltimateBlue™ are trademarks of RFMD, LLC. BLUETOOTH is a trademark owned by Bluetooth SIG, Inc., U.S.A. and licensed for use by RFMD. All other trade names, trademarks and registered trademarks are the property of their respective owners. ©2006, RF Micro Devices, Inc.

Absolute Maximum Ratings

Parameter	Rating	Unit
Supply Voltage in Standby Mode	-0.3 to +6.0	V
Supply Voltage in Idle Mode	-0.3 to +6.0	V
Supply Voltage in Operating Mode	-0.3 to +6.0	V
Power Control Voltage (V_{RAMP})	-0.3 to +1.8	V
Input RF Power	+10	dBm
Max Duty Cycle	50	%
Output Load VSWR	20:1	
Operating Temperature	-30 to +85	°C
Storage Temperature	-55 to +150	°C



Caution! ESD sensitive device.

Exceeding any one or a combination of the Absolute Maximum Rating conditions may cause permanent damage to the device. Extended application of Absolute Maximum Rating conditions to the device may reduce device reliability. Specified typical performance or functional operation of the device under Absolute Maximum Rating conditions is not implied.

RoHS status based on EUDirective2002/95/EC (at time of this document revision).

The information in this publication is believed to be accurate and reliable. However, no responsibility is assumed by RF Micro Devices, Inc. ("RFMD") for its use, nor for any infringement of patents, or other rights of third parties, resulting from its use. No license is granted by implication or otherwise under any patent or patent rights of RFMD. RFMD reserves the right to change component circuitry, recommended application circuitry and specifications at any time without prior notice.

Parameter	Specification			Unit	Condition
	Min.	Typ.	Max.		
ESD					
ESD RF Ports			1000	V	HBM, JESD22-A114
			1000	V	CDM, JED22-A114
ESD Antenna Port			8	KV	IEC, 61000-4-2
ESD Any Other Port			1000	V	HBM, JESD22-A114
			1000	V	CDM, JEDEC, JESD22-C101
Overall Power Control					
V_{RAMP}					
Power Control "ON"			1.8	V	Max. P_{OUT}
Power Control "OFF"		0.25		V	Min. P_{OUT}
V_{RAMP} Input Capacitance		15	20	pF	DC to 200kHz
V_{RAMP} Input Current			10	μA	$V_{RAMP} = V_{RAMP\ MAX}$
Power Control Range		50		dB	$V_{RAMP} = 0.25V$ to $V_{RAMP\ MAX}$
Overall Power Supply					
Power Supply Voltage	3.0	3.5	4.8	V	Operating Limits
Power Supply Current		1	20	μA	$P_{IN} < -30dBm$, TX Enable=Low, $V_{RAMP} = 0.25V$, Temp = -20 °C to +85 °C, $V_{BATT} = 4.8V$
Overall Control Signals					
GpCtrl0, GpCtrl1 "Low"	0	0	0.5	V	
GpCtrl0, GpCtrl1 "High"	1.25	2.0	3.0	V	
GpCtrl0, GpCtrl1 "High Current"		1	2	μA	
TX Enable "Low"	0	0	0.5	V	
TX Enable "High"	1.25	2.0	3.0	V	
TX Enable "High Current"		1	2	μA	
RF Port Input and Output Impedance		50		Ω	

TX ENABLE	GpCtrl1	GpCtrl0	TX Module Mode
0	0	0	Low Power Mode (Stand-by)
0	1	0	RX 0
0	1	1	RX 1
1	1	0	GSM900 TX Mode
1	1	1	DCS1800 TX Mode

Parameter	Specification			Unit	Condition
	Min.	Typ.	Max.		
GSM900 Band					Nominal conditions unless otherwise stated. All unused ports are terminated. $V_{BATT}=3.5V$, $P_{IN}=3\text{ dBm}$, Temp= $+25^{\circ}\text{C}$, TX Enable=High, $V_{RAMP}=1.8V$ TX Mode: GpCtrl1=High, GpCtrl0=Low, Duty Cycle=25%, Pulse Width=1154 μs
Operating Frequency Range	880		915	MHz	
Input Power	0	3	6	dBm	Full P_{OUT} guaranteed at minimum drive level.
Input VSWR			2.5:1		Over P_{OUT} range (5 dBm to 33 dBm)
Maximum Output Power	33	33.7		dBm	Duty Cycle=25%, Pulse Width=1154 μs
	31	33.6		dBm	$V_{BATT}=3.0V$ to 4.8V, $P_{IN}=0\text{ dBm}$ to 6 dBm, Temp= -20°C to $+85^{\circ}\text{C}$, Duty Cycle=50%, Pulse Width=2308 μs , $V_{RAMP}\leq 1.8V$
Minimum Power Into 3:1 VSWR	30.5			dBm	The measured delivered output power to the load with the mismatch loss already taken into account with 1dB variation margin. $V_{BATT}=3.7V$.
Efficiency	36	41	60	%	Set $V_{RAMP}=V_{RAMP}$ rated for $P_{OUT}=33\text{ dBm}$
2nd Harmonic		-40*	-33	dBm	$V_{RAMP}=V_{RAMP}$ rated for $P_{OUT}=33\text{ dBm}$. *Typical value measured from worst case harmonic frequency across the band.
3rd Harmonic		-40*	-33	dBm	$V_{RAMP}=V_{RAMP}$ rated for $P_{OUT}=33\text{ dBm}$. *Typical value measured from worst case harmonic frequency across the band.
All other harmonics up to 12.75GHz		-40	-33	dBm	$V_{RAMP}=V_{RAMP}$ rated for $P_{OUT}=33\text{ dBm}$.
Non-Harmonic Spurious up to 12.75GHz			-36	dBm	$V_{RAMP}=V_{RAMP}$ rated for $P_{OUT}=33\text{ dBm}$, also over all power levels (5 dBm to 33 dBm)
Forward Isolation 1		-54	-41	dBm	TX Enable=Low, $P_{IN}=6\text{ dBm}$, $V_{RAMP}=0.25V$
Forward Isolation 2		-28	-15	dBm	TX Enable=High, $P_{IN}=6\text{ dBm}$, $V_{RAMP}=0.25V$
Output Noise Power					
925 MHz to 935 MHz		-87	-77	dBm	$V_{RAMP}=V_{RAMP}$ rated for $P_{OUT}=33\text{ dBm}$, RBW=100 kHz
935 MHz to 960 MHz		-89	-83	dBm	
1805 MHz to 1880 MHz		-93	-87	dBm	
Output Load VSWR Stability (Spurious Emissions)			-36	dBm	VSWR=12:1; all phase angles (Set $V_{RAMP}=V_{RAMP}$ rated for $P_{OUT}\leq 33\text{ dBm}$ into 50 Ω load; load switched to VSWR=12:1)
Output Load VSWR Ruggedness	No damage or permanent degradation to device				VSWR=20:1; all phase angles (Set $V_{RAMP}=V_{RAMP}$ rated for $P_{OUT}=33\text{ dBm}$ into 50 Ω load; load switched to VSWR=20:1)

Parameter	Specification			Unit	Condition
	Min.	Typ.	Max.		
DCS1800 Band					Nominal conditions unless otherwise stated. All unused ports are terminated. $V_{BATT}=3.5V$, $P_{IN}=3\text{ dBm}$, Temp= $+25^{\circ}\text{C}$, TX Enable=High, $V_{RAMP}=1.8V$ TX Mode: GpCtrl1=High, GpCtrl0=High, Duty Cycle=25%, Pulse Width=1154 μs
Operating Frequency Range	1710		1785	MHz	
Input Power	0	3	6	dBm	Full P_{OUT} guaranteed at minimum drive level.
Input VSWR			2.5:1		Over P_{OUT} range (0dBm to 30dBm)
Maximum Output Power	30.0	31.5		dBm	Duty Cycle=25%, Pulse Width=1154 μs
	28	31.5		dBm	$V_{BATT}=3.0V$ to 4.8V, $P_{IN}=0\text{ dBm}$ to 6dBm, Temp= -20°C to $+85^{\circ}\text{C}$, Duty Cycle=50%, Pulse Width=2308 μs , $V_{RAMP}\leq 1.8V$
Minimum Power Into 3:1 VSWR	27			dBm	The measured delivered output power to the load with the mismatch loss already taken into account with 1dB variation margin. $V_{BATT}=3.7V$.
Efficiency	32	38	60	%	Set $V_{RAMP}=V_{RAMP}$ rated for $P_{OUT}=30\text{ dBm}$
2nd Harmonic		-39*	-33	dBm	$V_{RAMP}=V_{RAMP}$ rated for $P_{OUT}=30\text{ dBm}$. *Typical value measured from worst case harmonic frequency across the band.
3rd Harmonic		-40*	-33	dBm	$V_{RAMP}=V_{RAMP}$ rated for $P_{OUT}=30\text{ dBm}$. *Typical value measured from worst case harmonic frequency across the band.
All other harmonics up to 12.75GHz		-40	-33	dBm	$V_{RAMP}=V_{RAMP}$ rated for $P_{OUT}=30\text{ dBm}$
Non-Harmonic Spurious up to 12.75GHz			-36	dBm	$V_{RAMP}=V_{RAMP}$ rated for $P_{OUT}=30\text{ dBm}$, also over all power levels (0dBm to 30dBm)
Forward Isolation 1		-55	-53	dBm	TX Enable=Low, $P_{IN}=6\text{ dBm}$, $V_{RAMP}=0.25V$
Forward Isolation 2		-25	-15	dBm	TX Enable=High, $P_{IN}=6\text{ dBm}$, $V_{RAMP}=0.25V$
Output Noise Power					
925 MHz to 935 MHz		-98	-77	dBm	$V_{RAMP}=V_{RAMP}$ rated for $P_{OUT}=30\text{ dBm}$, RBW = 100 kHz
935 MHz to 960 MHz		-98	-83	dBm	
1805 MHz to 1880 MHz		-92	-79	dBm	
Output Load VSWR Stability (Spurious Emissions)			-36	dBm	VSWR = 12:1; all phase angles (Set $V_{RAMP}=V_{RAMP}$ rated for $P_{OUT}\leq 30\text{ dBm}$ into 50 Ω load; load switched to VSWR = 12:1)
Output Load VSWR Ruggedness	No damage or permanent degradation to device				VSWR = 20:1; all phase angles (Set $V_{RAMP}=V_{RAMP}$ rated for $P_{OUT}=30\text{ dBm}$ into 50 Ω load; load switched to VSWR = 20:1)

Parameter	Specification			Unit	Condition
	Min.	Typ.	Max.		
RX Section					Nominal conditions unless otherwise stated. $V_{BATT} = 3.5V$, $P_{IN} = -10dBm$, Temp = +25°C, TX Enable = Low, $V_{RAMP} = 0.2V$ RX0 mode: GpCtrl1 = High, GpCtrl0 = Low RX1 mode: GpCtrl1 = High, GpCtrl0 = High, RX0 Freq = 925 MHz to 960 MHz, RX1 Freq = 1805 MHz to 1880 MHz
Insertion Loss GSM900 ANT-RX0/ RX1		1.1	1.3	dB	RX0 Freq = 925 MHz to 960 MHz.
In-Band Ripple GSM900 ANT-RX0/RX1		0.1	0.2	dB	RX0 Freq = 925 MHz to 960 MHz
Input VSWR GSM900 ANT-RX0/RX1		1.5:1	1.7:1		RX0 Freq = 925 MHz to 960 MHz
Insertion Loss DCS1800 ANT-RX0/RX1		1.3	1.6	dB	Freq = 1805 MHz to 1880 MHz.
In-Band Ripple DCS1800 ANT-RX0/RX1		0.1	0.2	dB	Freq = 1805 MHz to 1880 MHz
Input VSWR DCS1800 ANT-RX0/RX1		1.8:1	2.0:1		Freq = 1805 MHz to 1880 MHz
TX Section					
Switch Leakage P_{OUT} at RX Port GSM900 ANT-RX0/RX1		2	8	dBm	GSM900 TX mode: Freq = 880 MHz to 915 MHz, GpCtrl1 = High, GpCtrl0 = Low, $V_{RAMP} = V_{RAMP}$ rated for $P_{OUT} = 33dBm$ at antenna port. See Note 1.
Switch Leakage P_{OUT} at RX Port DCS1800 ANT-RX0/RX1		4	6	dBm	DCS1800 TX mode: Freq = 1710 MHz to 1785 MHz, GpCtrl1 = High, GpCtrl0 = High, $V_{RAMP} = V_{RAMP}$ rated for $P_{OUT} = 30dBm$ at antenna port. See Note 1.

Note:

1. The insertion loss values listed are measured into 50Ω without matching. Improved performance can be obtained by properly matching the antenna/receiver ports.

2. Isolation specification set to ensure at least the following isolation at rated power:

Calculation Example: Isolation = $P_{OUT} @ Antenna - P_{OUT} @ RX Port$. Isolation LB = 33-2 = 31 dB, HB = 30-4 = 26 dB.

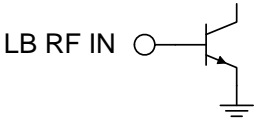
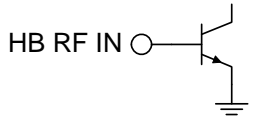
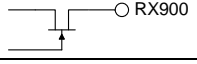
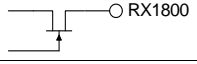
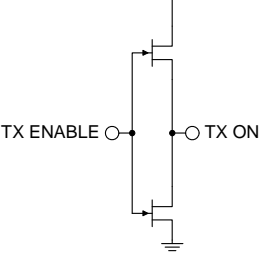
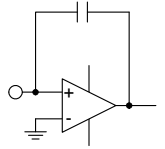
Pin	Function	Description	Interface Schematic
1	GND		
2	GND		
3	RFIN LB	RF input to the GSM900 band. This is a 50Ω input.	
4	GND		
5	RFIN HB	RF input to the DCS1800 band. This is a 50Ω input.	
6	GND		
7	GND		
8	GND		
9	GND		
10	NC		
11	RX0	RX0 port of antenna switch. This is a 50Ω output. RX0 is interchangeable with RX1.	
12	RX1	RX1 port of antenna switch. This is a 50Ω output. RX1 is interchangeable with RX0.	
13	NC		
14	ANTENNA	Antenna port.	
15	GND		
16	GND		
17	NC		
18	VBATT	Power supply for the module. This should be connected to the battery terminal using as wide a trace as possible.	
19	GPCTRL1	Control pin that together with GpCtrl0 selects band of operation.	
20	GPCTRL0	Control pin that together with GpCtrl1 selects band of operation.	
21	TX ENABLE	This signal enables the PA module for operation with a logic high. The switch is put in TX mode determined by GpCtrl0 and GpCtrl1.	
22	VRAMP	V _{RAMP} ramping signal from DAC. A simple RC filter is integrated into the RF7166 module. V _{RAMP} may or may not require additional filtering depending on the baseband selected.	
23	GND		

Pin Out
(Top View)

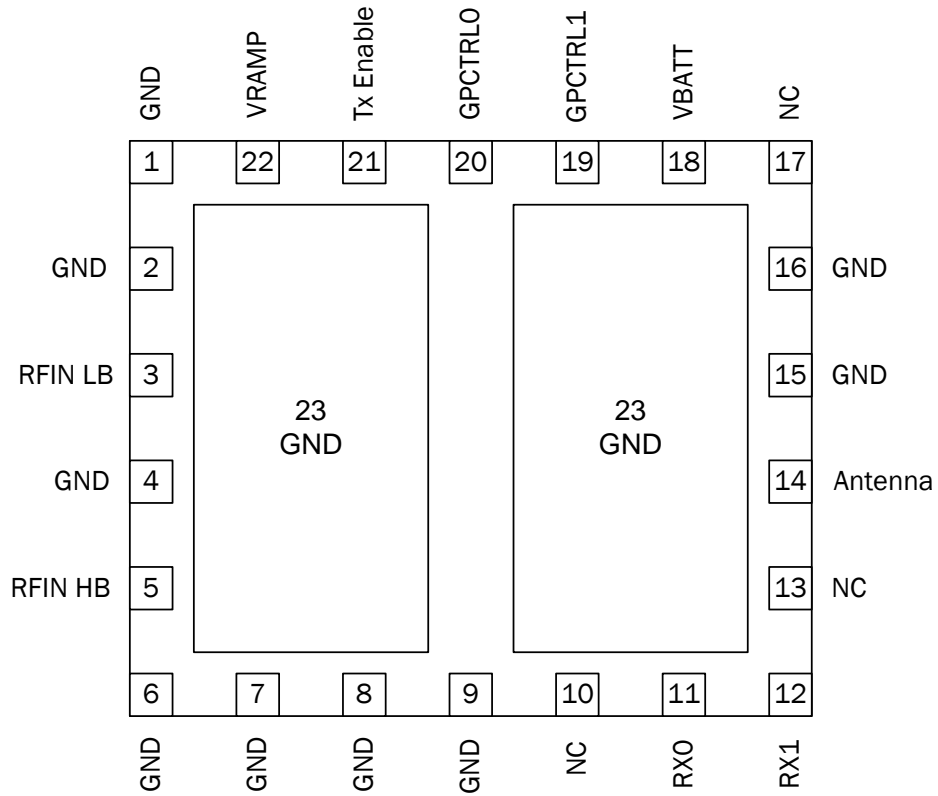

Theory of Operation

Product Description

The RF7166 is a dual-band, transmit module (TXM) with fully-integrated power control functionality, harmonic filtering, band selectivity, and TX/RX switching. The TXM is self-contained, having 50Ω I/O terminals and two symmetrical RX ports allowing dual-band operation. The power control function eliminates all power control circuitry, including directional couplers, diode detectors, and power control ASICs, etc. The power control capability provides 50dB of continuous control range and 70dB of total control range, using a DAC-compatible, analog voltage input. The TX Enable feature provides for PA activation (TX mode) or RX mode/standby. Internal switching provides a low-loss, low-distortion path from the antenna port to the TX path (or RX port), while maintaining proper isolation. Integrated filtering provides ETSI-compliant harmonic suppression at the antenna port even under high mismatch conditions, which is important as modern antennas often present a load that significantly deviates from nominal impedance.

Overview

The RF7166 simplifies the phone design by eliminating the need for the complicated control loop, harmonic filters, and TX/RX switch along with their associated matching components. The power control loop can be driven directly from the DAC output in the baseband circuit. The module has two RX ports for EGSM900 and DCS1800 bands of operation. The two RX ports are symmetrical; they can be used either as EGSM900 or DCS1800. To control the mode of operation, there are three logic control signals: TX Enable, GpCtrl0, and GpCtrl1. The RF7166 offers high efficiency at the rated P_{OUT} as backed-off efficiency is improved in this TXM.

Power Ramping and Timing

The RF7166 should be powered on according to the power-on sequence below. It is designed to prevent operation of the amplifier under conditions that could cause damage to the device or erratic operation.

There are some setup times associated with the control signals of the RF7166. The most important of these is the settling time between TXEN going high and when V_{RAMP} can begin to increase. This time is often referred to as the "pedestal" and is required so that the internal power control loop and bias circuitry can settle after being turned on. The RF7166 requires at least 2μs or two quarter-bit times for proper settling of the power control loop.

The power-down sequence is in opposite order of the power-on sequence. As described in the figure below, V_{BATT} is applied first to provide bias to the silicon control chip. Then the RF drive is applied. Finally, when TXEN is high, the V_{RAMP} signal is held at a constant 0.25V, and 2μs later, V_{RAMP} begins to ramp up. The shape of V_{RAMP} is important for maintaining the switching transients. The basic shape of the ramping function should be raised cosine to achieve best transient performance.

Power On Sequence

Power On Sequence

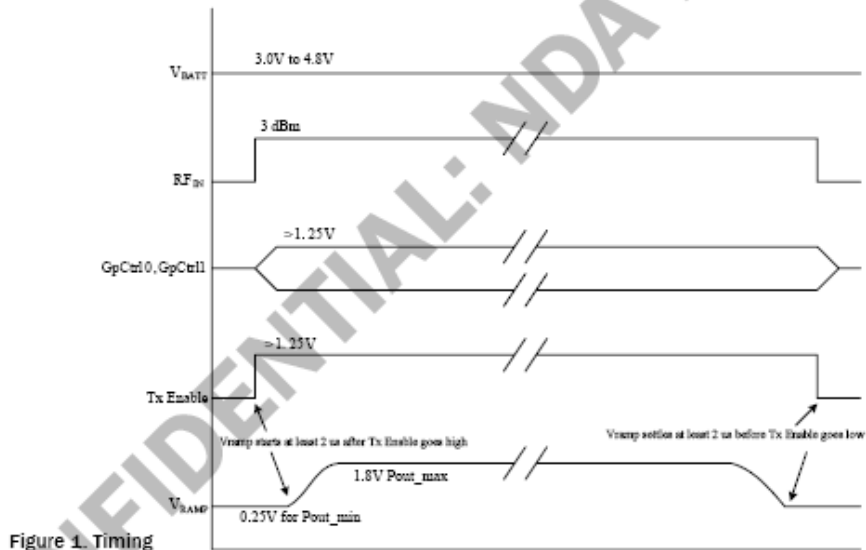

Figure 1. Timing

Figure 1. Timing Diagram

1. Apply V_{BATT}
2. Apply GpCtrl0, GpCtrl1, RF_{IN} and TX Enable
3. Apply V_{RAMP} at least 2 μs after TX Enable
4. The Power Down Sequence is in opposite order of the Power On Sequence

Power Flattening and V_{BATT} Tracking

The RF7166 has an integrated power flattening circuit that reduces the amount of current variation when a mismatch is presented to the output of the PA. When a mismatch is presented to the output of the PA, its output impedance is varied and could present a load that will increase output power. As the output power increases, so does current consumption. The current consumption can become very high if not monitored and limited. The power flattening circuit is integrated onto the CMOS controller and requires no input from the user.

Into a mismatch, the current varies as the phase changes. The power flattening circuit monitors current through an internal sense resistor. As the current changes, the loop is adjusted in order to maintain current. The result is flatter power and reduced current into mismatch. The transceiver/baseband to regulate the ramping signal as the supply voltage decreases. The internal circuit monitors the supply voltage and adjusts the ramping signal such that the switching spectrum is minimally impacted.

The RF7166 also incorporates a V_{BATT} tracking feature that eliminates the need for the transceiver/baseband to regulate the ramping signal as the supply voltage decreases. The internal circuit monitors the supply voltage and adjusts the ramping signal such that the switching spectrum is minimally impacted.

Application Schematic

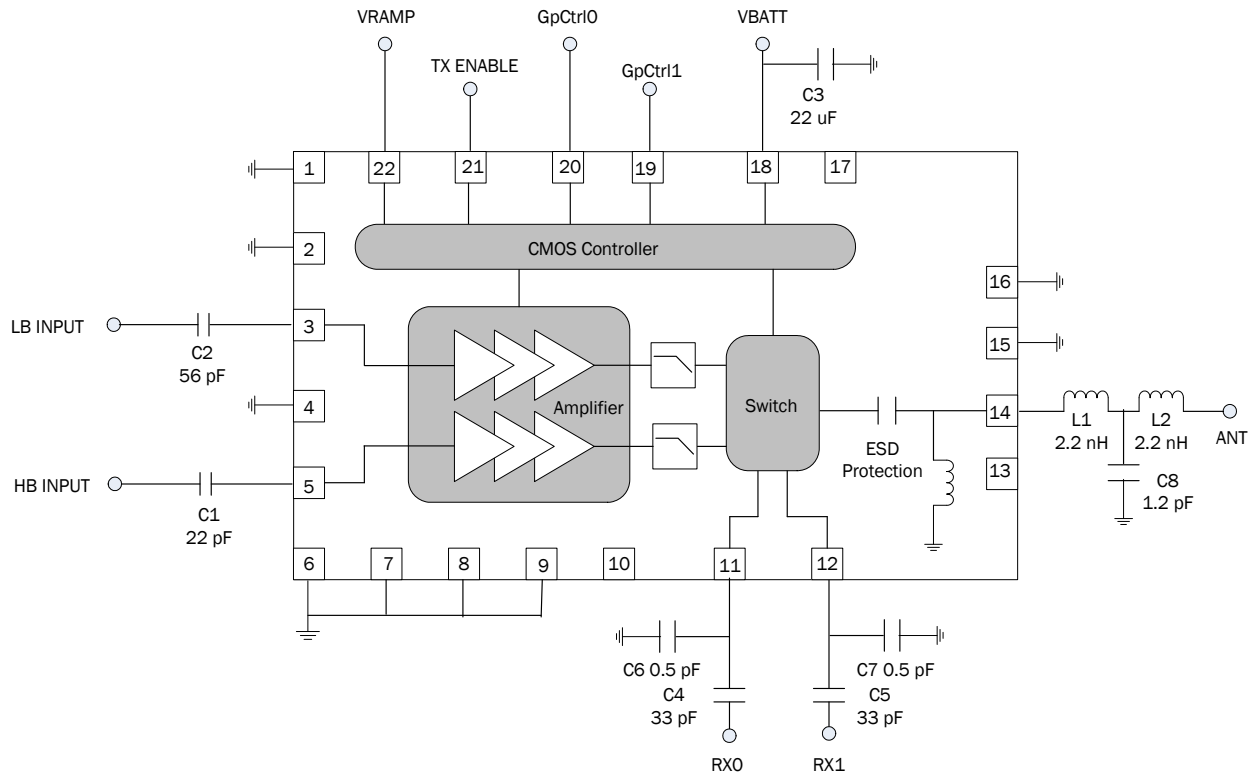

*All inputs, outputs, and antenna traces are 50 Ω micro strip.
 **VBATT capacitor value may change depending on application.
 ***RX0 and RX1 usually connect to SAW filters; C4 and C5 are used to block dc voltage present on the RX ports. C6 and C7 are used to match the RX ports to a 50 Ω filter.
 ****If placing an attenuation network on the input to the power amplifier, ensure that it is positioned on the transceiver side of capacitor C1 (or C2) to prevent adversely affecting the base biasing of the power amplifier.
 *****L1, L2, and C8 is a suggested external LPF to suppress higher order harmonics. Actual component values will depend on the application.

Evaluation Board Layout Board Size 2.0" x 2.0" Board Thickness 0.032", Board Material FR-4/Rogers, Multi-layer

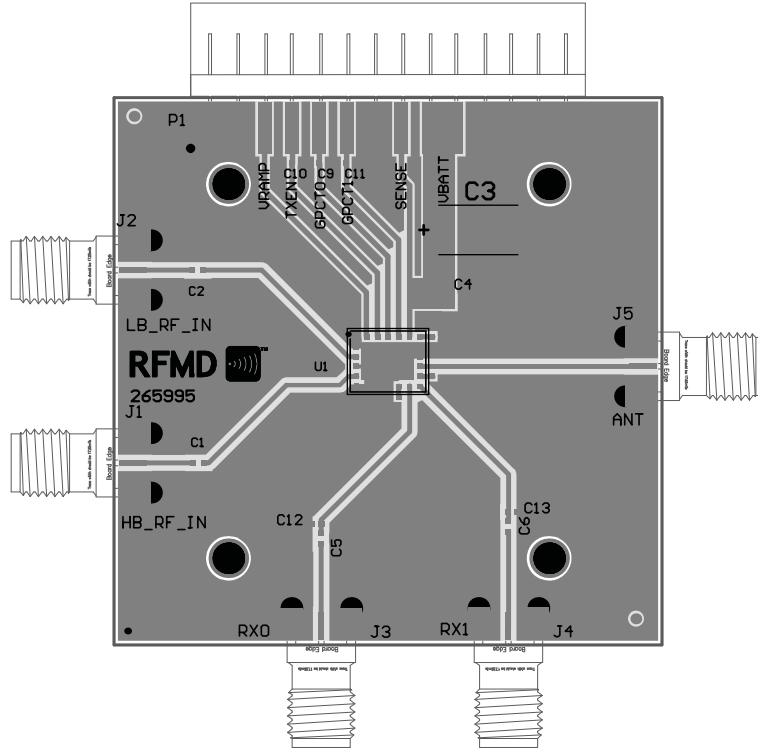

Package Drawing

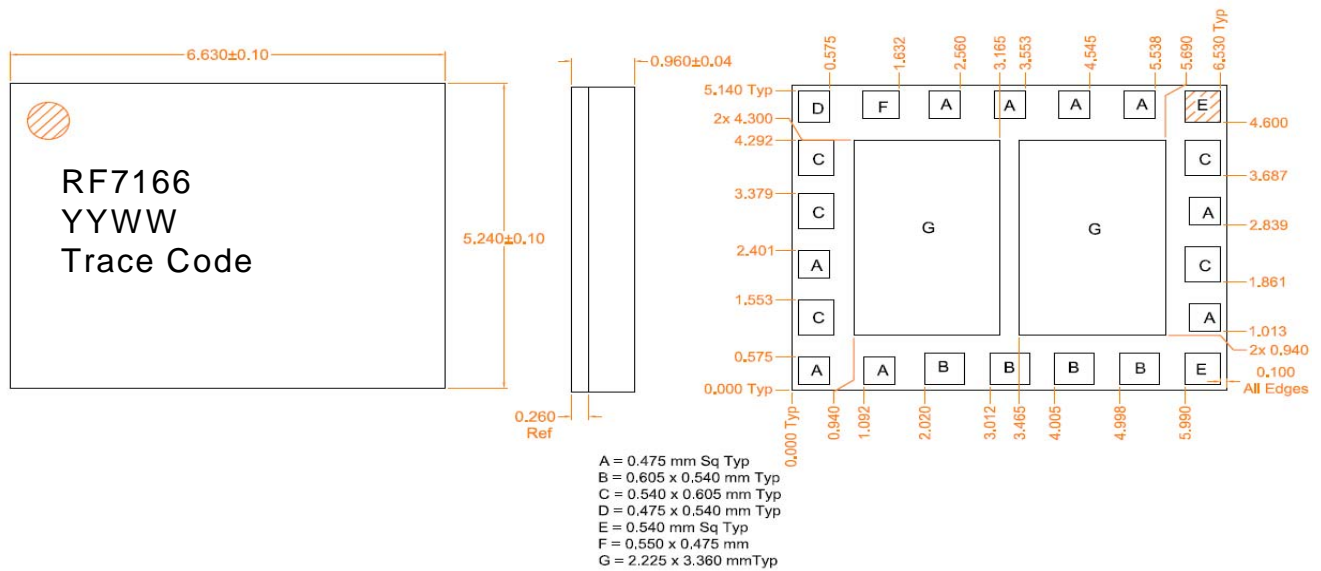

Notes:

YY indicates year, WW indicates work week, and Trace Code is a sequential number assigned at device assembly. Shaded areas represent Pin 1 location.

PCB Design Requirements

PCB Surface Finish

The PCB surface finish used for RFMD's qualification process is electroless nickel, immersion gold. Typical thickness is 3µinch to 8µinch gold over 180µinch nickel.

PCB Land Pattern Recommendation

PCB land patterns for RFMD components are based on IPC-7351 standards and RFMD empirical data. The pad pattern shown has been developed and tested for optimized assembly at RFMD. The PCB land pattern has been developed to accommodate lead and package tolerances. Since surface mount processes vary from company to company, careful process development is recommended.

PCB Metal Land and Solder Mask Pattern

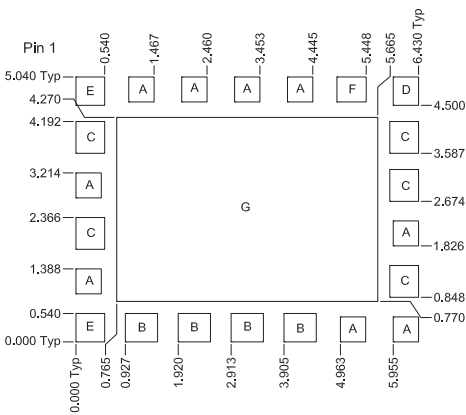

PCB METAL LAND PATTERN

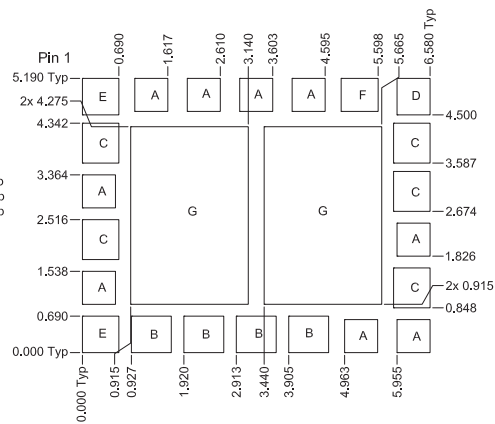

PCB SOLDER MASK PATTERN

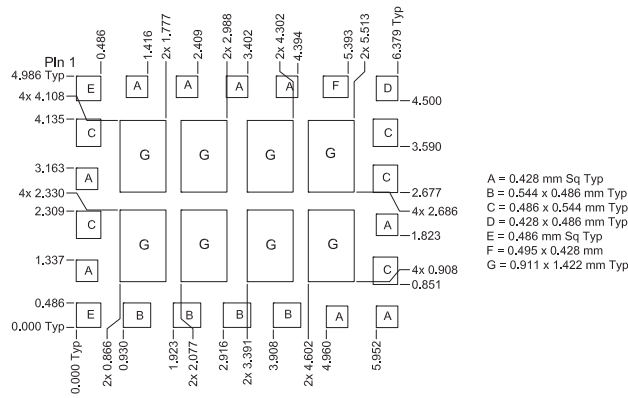

PCB STENCIL PATTERN

Tape and Reel

Carrier tape basic dimensions are based on EIA 481. The pocket is designed to hold the part for shipping and loading onto SMT manufacturing equipment, while protecting the body and the solder terminals from damaging stresses. The individual pocket design can vary from vendor to vendor, but width and pitch will be consistent.

Carrier tape is wound or placed onto a shipping reel either 330mm (13 inches) in diameter or 178mm (7 inches) in diameter. The center hub design is large enough to ensure the radius formed by the carrier tape around it does not put unnecessary stress on the parts.

Prior to shipping, moisture sensitive parts (MSL level 2a-5a) are baked and placed into the pockets of the carrier tape. A cover tape is sealed over the top of the entire length of the carrier tape. The reel is sealed in a moisture barrier ESD bag with the appropriate units of desiccant and a humidity indicator card, which is placed in a cardboard shipping box. It is important to note that unused moisture sensitive parts need to be resealed in the moisture barrier bag. If the reels exceed the exposure limit and need to be rebaked, most carrier tape and shipping reels are not rated as bakeable at 125 °C. If baking is required, devices may be baked according to section 4, table 4-1, of Joint Industry Standard IPC/JEDEC J-STD-033.

The table below provides information for carrier tape and reels used for shipping the devices described in this document.

Tape and Reel

RFMD Part Number	Reel Diameter Inch (mm)	Hub Diameter Inch (mm)	Width (mm)	Pocket Pitch (mm)	Feed	Units per Reel
RF7166TR13	13 (330)	4 (102)	12	8	Single	2500
RF7166TR7	7 (178)	2.4 (61)	12	8	Single	750

Unless otherwise specified, all dimension tolerances per EIA-481.

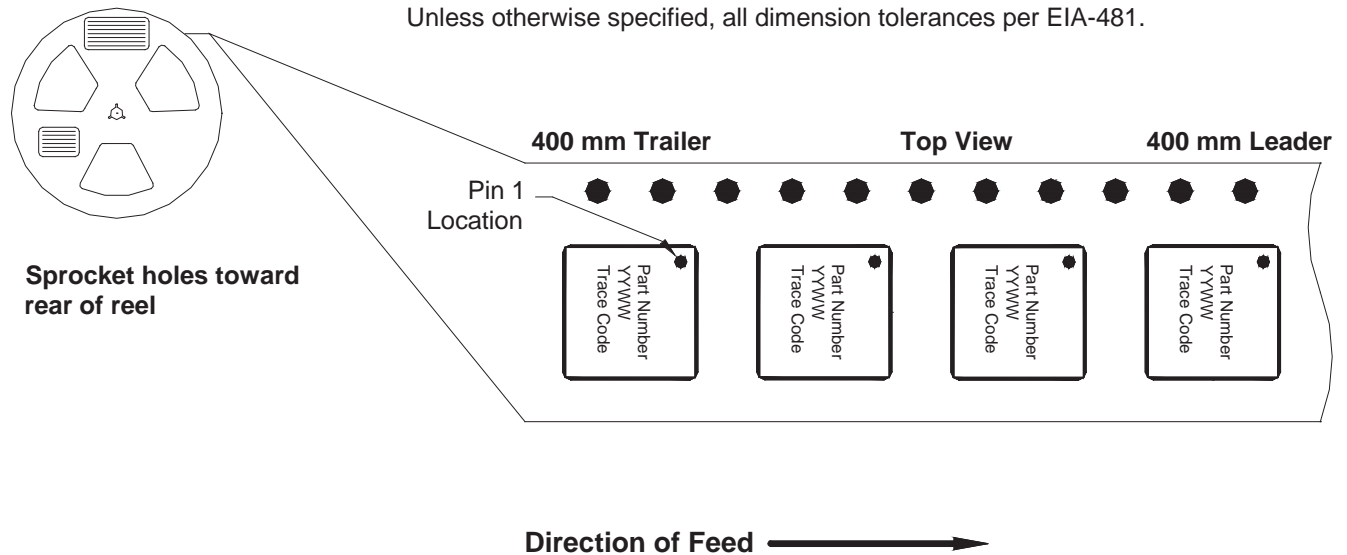

Figure 1. 5.24mmx6.63mm (Carrier Tape Drawing with Part Orientation)

RoHS* Banned Material Content

RoHS Compliant: Yes
 Package total weight in grams (g): 0.121
 Compliance Date Code: -
 Bill of Materials Revision: -
 Pb Free Category: e4

Bill of Materials	Parts Per Million (PPM)					
	Pb	Cd	Hg	Cr VI	PBB	PBDE
Die	0	0	0	0	0	0
Molding Compound	0	0	0	0	0	0
Lead Frame	0	0	0	0	0	0
Die Attach Epoxy	0	0	0	0	0	0
Wire	0	0	0	0	0	0
Solder Plating	0	0	0	0	0	0

This RoHS banned material content declaration was prepared solely on information, including analytical data, provided to RFMD by its suppliers, and applies to the Bill of Materials (BOM) revision noted above.

* DIRECTIVE 2002/95/EC OF THE EUROPEAN PARLIAMENT AND OF THE COUNCIL of 27 January 2003 on the restriction of the use of certain hazardous substances in electrical and electronic equipment