



Features

- RF: 1300MHz to 2200MHz
- LO: 1200MHz to 2400MHz
- IF: 50MHz to 300MHz
- Operates Both High and Low-Side LO
- Conversion Gain: 8.5dB (IF=50MHz)
- Input IP3: 29dBm
- Input P1dB: 12dBm
- Adjustable Current and IP3 (via IFBIAS)
- Single +5V Supply

Applications

- Cellular, 3G Infrastructure
- WiBro, WiMax LTE
- Wireless Backhaul
- High Performance Communications Systems
- GMSK, QPSK, DQPSK, QAM Modulation

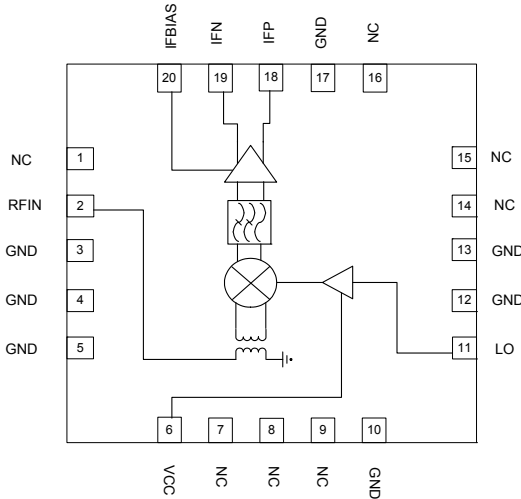

Functional Block Diagram

Product Description

The RFX1015 is a high linearity downconverter module designed for use in Cellular, 3G, LTE, and other high performance communications systems. The RFX1015 contains an integrated LO buffer amp and a passive mixer core with an amplified differential IF output. The integrated LO buffer lowers the LO drive requirement to a friendly 0dBm typical. The RFX1015 supports both low and high-side LO injection for IF frequencies up to 300MHz. The RFX1015 also offers an adjustable IP3 range via the IFBIAS pin. Users can lower the IF amplifier DC current to save DC power when they don't require the device's peak linearity performance.

Ordering Information

RFMX1015SQ	Sample Bag with 25 pieces
RFMX1015SR	7" Reel with 100 pieces
RFMX1015TR7	7" Reel with 750 pieces
RFMX1015TR13	13" Reel with 2500 pieces
RFMX1015PCK-410	1300MHz to 2200MHz PCBA with 5-piece Sample Bag

Optimum Technology Matching® Applied

- | | | | |
|---|--|-------------------------------------|------------------------------------|
| <input type="checkbox"/> GaAs HBT | <input type="checkbox"/> SiGe BiCMOS | <input type="checkbox"/> GaAs pHEMT | <input type="checkbox"/> GaN HEMT |
| <input checked="" type="checkbox"/> GaAs MESFET | <input type="checkbox"/> Si BiCMOS | <input type="checkbox"/> Si CMOS | <input type="checkbox"/> BIFET HBT |
| <input checked="" type="checkbox"/> InGaP HBT | <input checked="" type="checkbox"/> SiGe HBT | <input type="checkbox"/> Si BJT | <input type="checkbox"/> LDMOS |

Absolute Maximum Ratings

Parameter	Rating	Unit
Supply Voltage (V_{CC})	5.5	V
Maximum RF Input Power	18	dBm
Maximum LO Input Power	10	dBm
Maximum Power Dissipation	1.5	W
Operating Temperature Range	-40 to +85	°C
Storage Temperature Range	-40 to +150	°C
Maximum Junction Temperature	+150	°C
ESD Rating - Human Body Model	Class 1A	
Moisture Sensitivity Level	MSL 3	



Caution! ESD sensitive device.

Exceeding any one or a combination of the Absolute Maximum Rating conditions may cause permanent damage to the device. Extended application of Absolute Maximum Rating conditions to the device may reduce device reliability. Specified typical performance or functional operation of the device under Absolute Maximum Rating conditions is not implied.

RoHS status based on EUDirective2002/95/EC (at time of this document revision).

The information in this publication is believed to be accurate and reliable. However, no responsibility is assumed by RF Micro Devices, Inc. ("RFMD") for its use, nor for any infringement of patents, or other rights of third parties, resulting from its use. No license is granted by implication or otherwise under any patent or patent rights of RFMD. RFMD reserves the right to change component circuitry, recommended application circuitry and specifications at any time without prior notice.

Parameter	Specification			Unit	Condition
	Min.	Typ.	Max.		
General Performance					
Conversion Gain	7.5	8.5	9.5	dB	$f_{RF}=1960\text{MHz}$, $f_{LO}=1810\text{MHz}$
Input Third Order Intercept		29		dBm	$f_{RF1}=1960\text{MHz}$, $f_{RF2}=1961\text{MHz}$, $f_{LO}=1810\text{MHz}$, -5dBm/tone
Input 1dB Compression Point		12		dBm	$f_{RF}=1960\text{MHz}$, $f_{LO}=1810\text{MHz}$
Noise Figure		14.5		dB	SSB NF, $f_{RF}=1960\text{MHz}$, $f_{LO}=1910\text{MHz}$
LO Leakage at RF Port		-24		dBm	$LO=0\text{dBm}$, $f_{RF}=1960\text{MHz}$, $f_{LO}=1810\text{MHz}$
LO Leakage at IF Port		-26		dBm	$LO=0\text{dBm}$, $f_{RF}=1960\text{MHz}$, $f_{LO}=1810\text{MHz}$
RF to IF Isolation		43		dB	$LO=0\text{dBm}$, $P_{RF}=0\text{dBm}$, $f_{RF}=1960\text{MHz}$, $f_{LO}=1810\text{MHz}$
2RF to 2LO Spurious Response		-65		dBc	$P_{RF}=-10\text{dBm}$, $f_{RF}=1960\text{MHz}$, $f_{LO}=1810\text{MHz}$
3RF to 3LO Spurious Response		-76		dBc	$P_{RF}=-10\text{dBm}$, $f_{RF}=1960\text{MHz}$, $f_{LO}=1810\text{MHz}$
RF Interface					
Frequency Range	1300		2200	MHz	
Input Return Loss		>10		dB	IF port terminated, $LO=0\text{dBm}$, $1.7\text{GHz}<f_{RF}<2.2\text{GHz}$
Input Impedance		50		Ω	
LO Interface					
Frequency Range	1200		2400	MHz	
LO Input Power	-3	0	3	dBm	
Return Loss		15		dB	IF port terminated
Impedance		50		Ω	
IF Interface					
Frequency Range	50		300	MHz	
Output Return Loss		15		dB	
Differential Output Impedance		200		Ω	
Power Supply					
Supply Voltage (V_{CC})	4.75	5	5.25	V	
Supply Current (I_{CC})	150	200	240	mA	Sum of all currents.
Thermal Resistance of LO Amp		93		C/W	Based on LO Amp current (pin 6)
Thermal Resistance of IF Amp		88		C/W	Based on IF Amp current (pins 18 and 19)

Notes:

- Data shown for $V_{CC}=5.0\text{V}$, $LO\text{ Power}=0\text{dBm}$, $T=25^\circ\text{C}$
- All measurements performed with an RFMD IF BALUN (P/N RFXF2553) on the EVM.

Typical Performance: $V_{CC}=5.0V$, $P_{LO}=0dBm$, $P_{RF}=0dBm$, $f_{IF}=150MHz$, unless otherwise noted

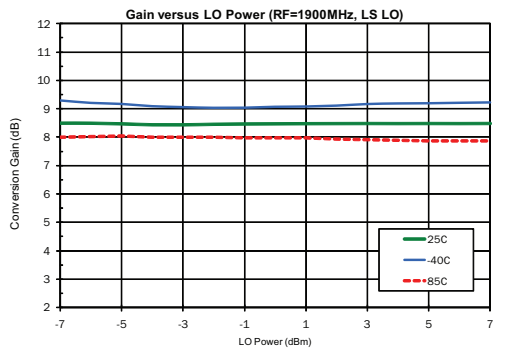
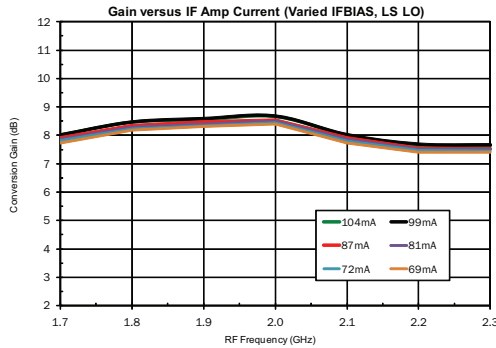
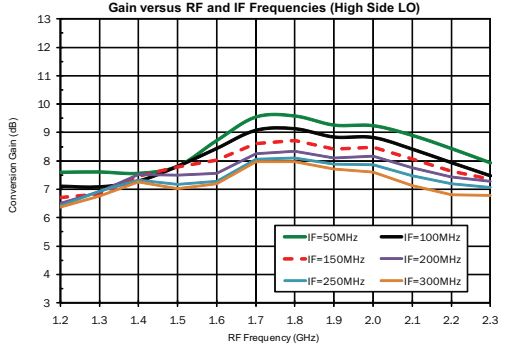
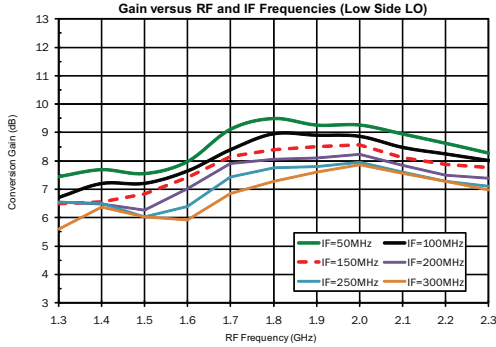
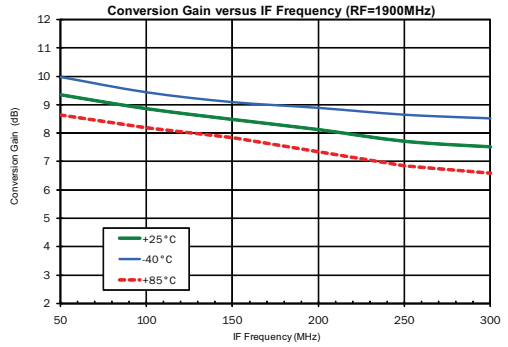
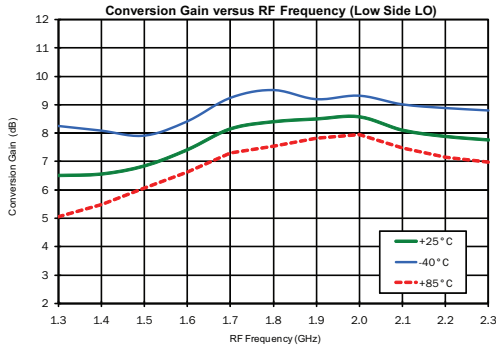

Typical Performance: $V_{CC}=5.0V$, $P_{LO}=0dBm$, $P_{RF}=0dBm$, $f_{IF}=150MHz$, unless otherwise noted

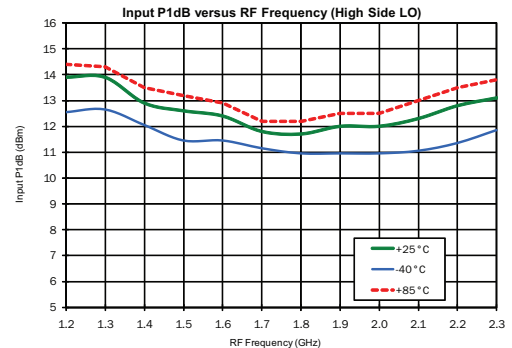
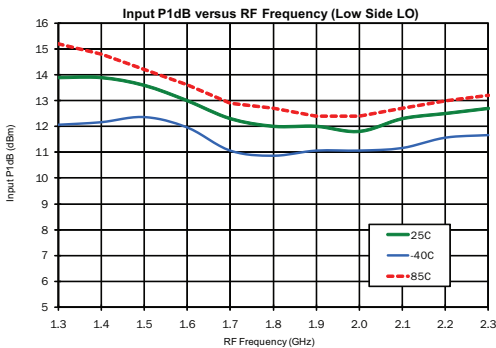
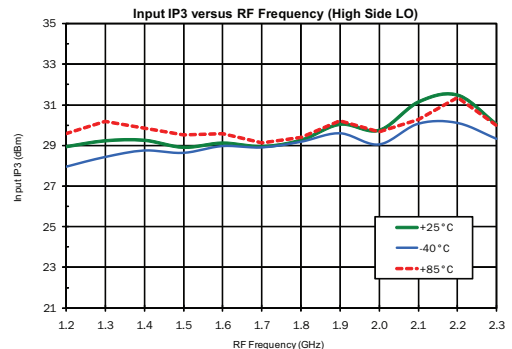
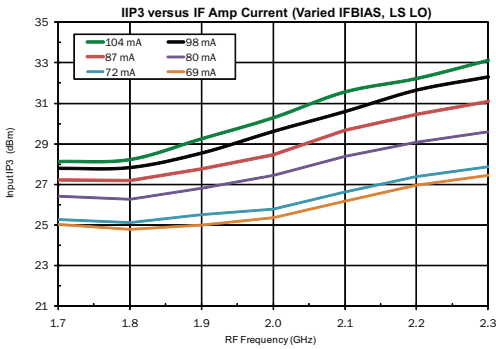
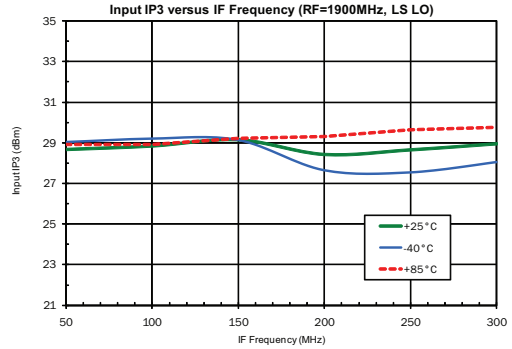
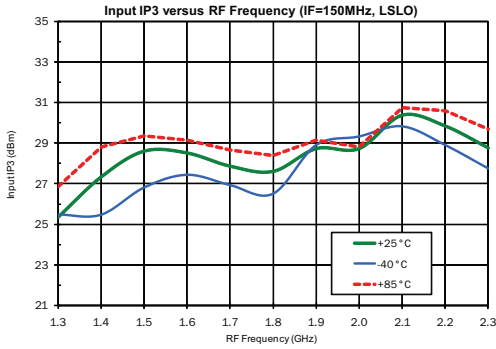

Typical Performance: $V_{CC}=5.0V$, $P_{LO}=0dBm$, $P_{RF}=0dBm$, $f_{IF}=150MHz$, unless otherwise noted

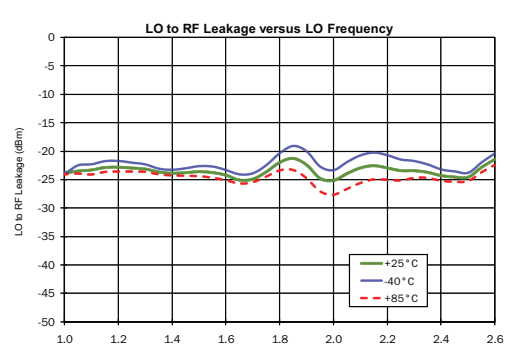
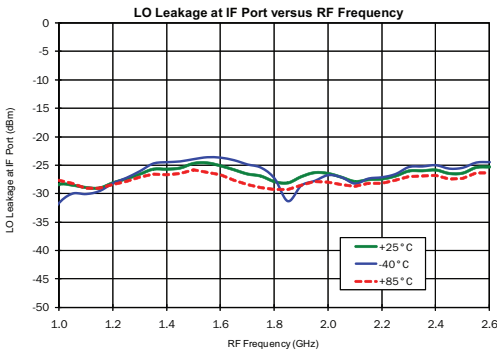
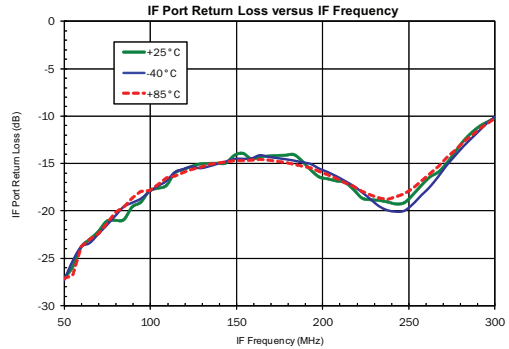
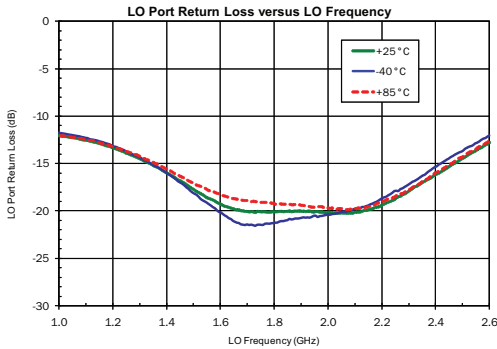
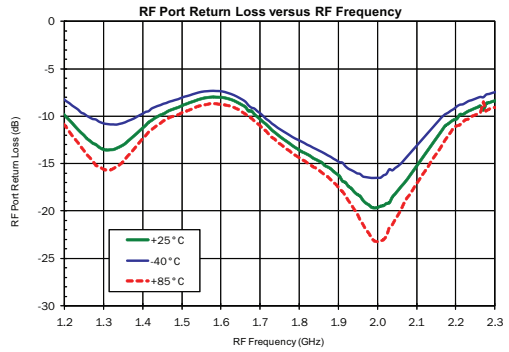
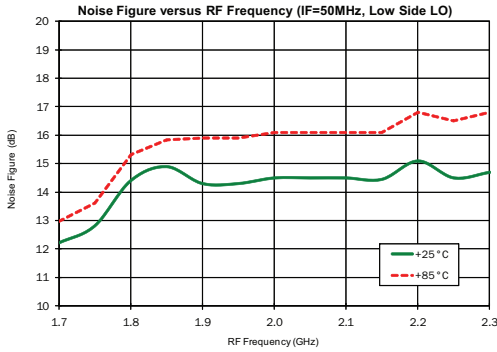

Typical Performance: $V_{CC}=5.0V$, $P_{LO}=0dBm$, $P_{RF}=0dBm$, $f_{IF}=150MHz$, unless otherwise noted.

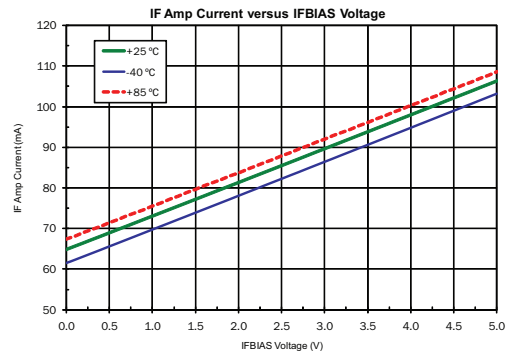
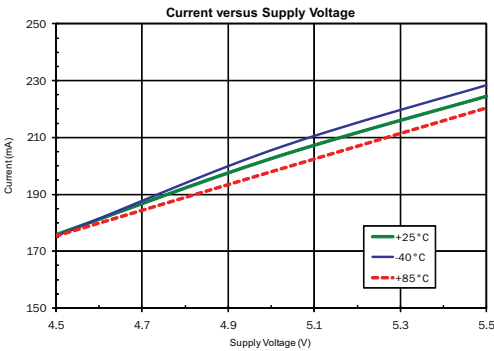
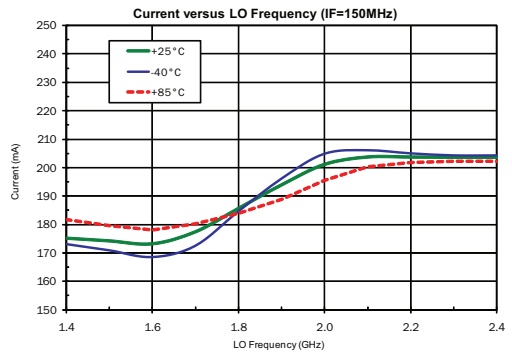
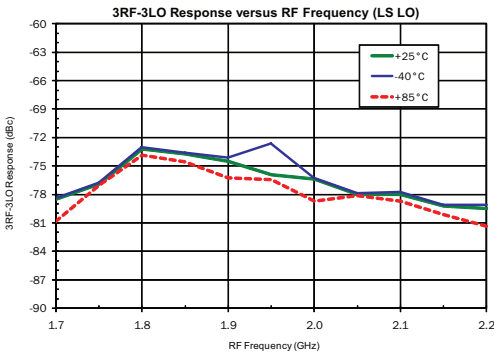
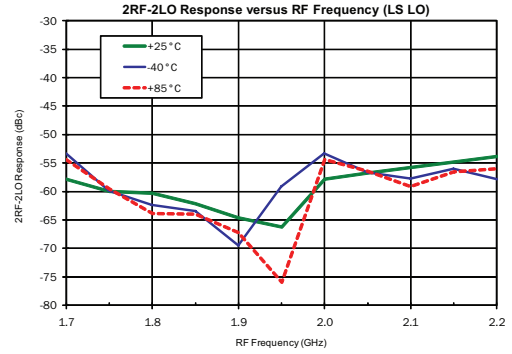
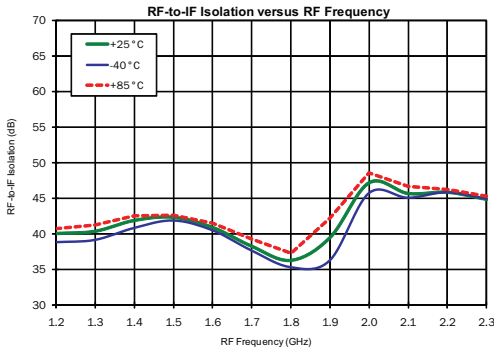

Evaluation Board Schematic

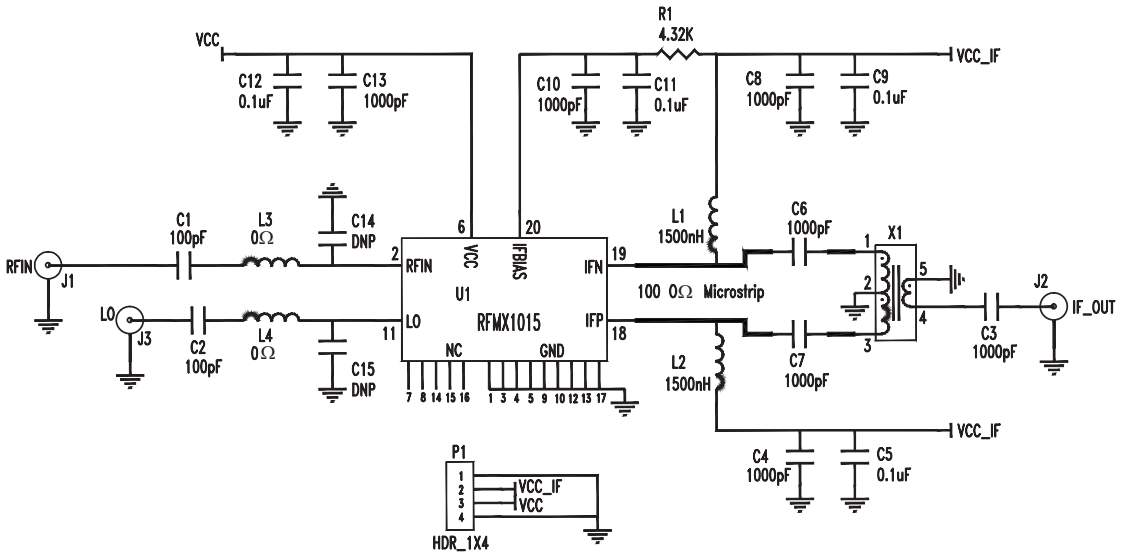

Evaluation Board Bill of Materials (BOM)

Description	Reference Designator	Manufacturer	Manufacturer's P/N
PCB			MXxO15410(C)
2GHz Differential IF Downconverter Module	U1	RFMD	RFX1015
CAP, 100pF, 5%, 50V, COG, 0402	C1-C2	Murata Electronics	GRM1555C1H101JZ01D
CAP, 1000pF, 10%, 50V, X7R, 0402	C3-C4, C6-C8, C10, C13	Murata Electronics	GRM155R71H102KA01E
CAP, 0.1uF, 10%, 16V, X7R, 0603	C5, C9, C11-C12	Murata Electronics	GRM188R71C104KA01D
CONN, SMA, END LNCH, MINI, FLT, 0.062"	J1-J3	Emerson Network Power	142-0741-851
IND, 1500nH, 5%, W/W, 1008	L1-L2	Coilcraft	1008CS-152XJBC
CONN, HDR, ST, PLRZD, 4-PIN, 0.100"	P1	ITW Pancon	MPSS100-4-C
RES, 4.32K, 1%, 1/16W, 0402	R1	Vishay Dale Electronics	CRCW0402 4K32 1% 100 RT7
RFXF2553, WELDED 350MHZ 1:4 TRANSFORMER	X1	RFMD	RFXF2553
RES, 0Ω, 0402	L3-L4	Kamaya, Inc	RMC1/16SJPTH
DNP	C14-C15		

Evaluation Board Assembly Drawing

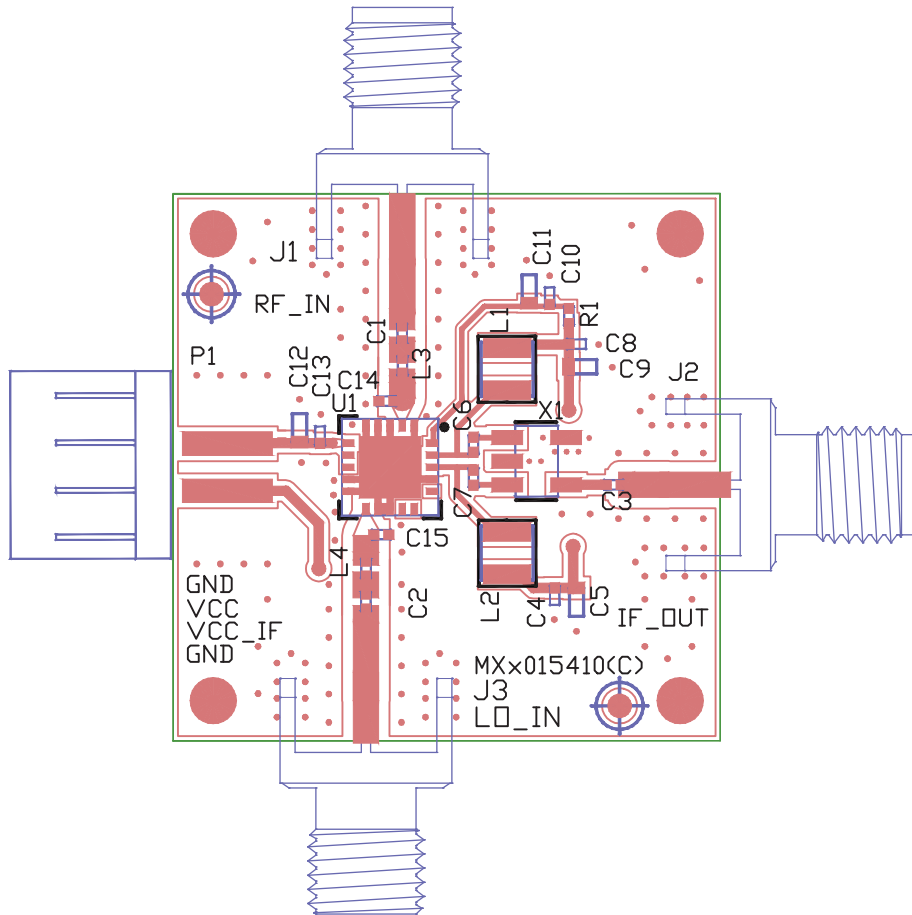

Pin Names and Description

Pin	Function	Description
1	NC	No internal connection. Can be NC or GND on the PCB.
2	RFIN	RF Single-ended input, external DC block required.
3	GND	Ground.
4	GND	Ground.
5	GND	Ground.
6	VCC	Supply voltage to Mixer and LO buffer amplifier.
7	NC	No internal connection. Can be NC or GND on the PCB.
8	NC	No internal connection. Can be NC or GND on the PCB.
9	NC	No internal connection. Can be NC or GND on the PCB.
10	GND	Ground.
11	LO	Local Oscillator Single-ended Input, external DC block required.
12	GND	Ground.
13	GND	Ground.
14	NC	No internal connection. Can be NC or GND on the PCB.
15	NC	No internal connection. Can be NC or GND on the PCB.
16	NC	No internal connection. Can be NC or GND on the PCB.
17	GND	Ground.
18	IFP	IF Differential Output and V _{CC} for IF Amplifier (collector voltage).
19	IFN	IF Differential Output and V _{CC} for IF Amplifier (collector voltage).
20	IFBIAS	IF Amplifier Current control (36mA range) Min Current: IFBIAS=0V (~69mA) Max Current: IFBIAS=5V (~105mA) Current between 69mA to 105mA: IFBIAS voltage between 0V to 5V.

IF Amplifier Current Adjustment Guidelines

(IFBIAS Voltage)

IF Amp Current (mA)	R1 Value (K Ω)	R1 Connection
105	0.0	IFBIAS to Vcc_IF
99	4.32	IFBIAS to Vcc_IF
89	100	IFBIAS to Vcc_IF
88	100.0	Open Circuit
81	10	IFBIAS to GND
72	1	IFBIAS to GND
77	0.1	IFBIAS to GND
69	0.0	IFBIAS to GND

Package Drawing (Dimensions in millimeters)

