



Package: SOT-89



Product Description

RFMD's SXB2089Z amplifier is a high linearity InGaP/GaAs Heterojunction Bipolar Transistor (HBT) MMIC housed in a low-cost, surface-mountable plastic package. These amplifiers are specially designed for use as driver devices for infrastructure equipment in the 5 MHz to 2500 MHz Cellular, ISM, WLL, PCS, and W-CDMA applications. It's high linearity makes it an ideal choice for multi-carrier as well as digital applications.

Features

- High OIP₃: +43 dBm at 1960 MHz
- P_{1dB}: 24 dBm
- High Linearity/ACP Performance
- Robust 2000V ESD, Class 2
- SOT-89 Package

Applications

- PA Driver Amplifier
- IF Amplifier
- Cellular, PCS, ISM, WLL, W-CDMA

Optimum Technology Matching® Applied

- GaAs HBT
- GaAs MESFET
- InGaP HBT
- SiGe BiCMOS
- Si BiCMOS
- SiGe HBT
- GaAs pHEMT
- Si CMOS
- Si BJT
- GaN HEMT
- RF MEMS

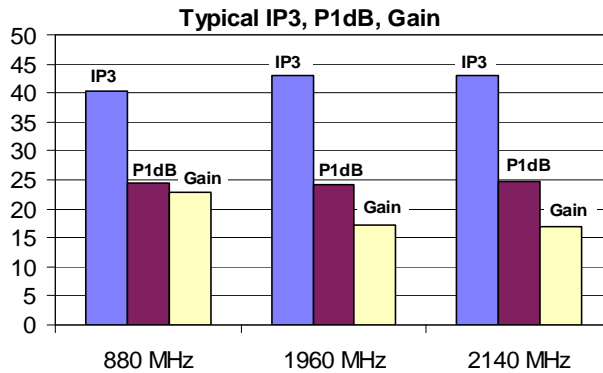

Parameter	Specification			Unit	Condition	
	Min.	Typ.	Max.			
Small Signal Gain		25.0		dBm	450MHz	
		21.5	23.0	24.5	dBm	880MHz
		15.5	17.0	21.5	dBm	1960MHz
			17.0		dBm	2140MHz
Input VSWR		1.1			450MHz	
		1.4	2.5		880MHz	
		1.6			1960MHz	
		1.3			2140MHz	
Output Power at 1dB Compression		24.0		dBm	450MHz	
	23.0	24.5		dBm	880MHz and 1960MHz	
		24.5		dBm	2140MHz	
		40.0		dBm	450MHz	
Third Order Intercept Point	38.0	41.0		dBm	880MHz	
	40.0	43.0		dBm	1960MHz	
		43.0		dBm	2140MHz	
		4.9		dB	450MHz	
Noise Figure		4.5	6.0	dB	880MHz	
		4.7		dB	1960MHz	
		4.2		dB	2140MHz	
		16.0		dBm	450MHz, IS-95, -55dBc ACP	
Channel Power IS-95		16.3		dBm	880MHz, IS-95, -55dBc ACP	
		15.5		dBm	1960MHz, IS-95, -55dBc ACP	
		15.6		dBm	2140MHz, WCDMA, -50dBc ACP	
	Thermal Resistance		51.3		°C/W	junction - lead
Device Operating Current	120	135	150	mA	V _S =8v, R _{BIAS} =20Ω, V _{DEVICE} =5.2V	

Test Conditions: T_A=25 °C, Z₀=50Ω, P_{OUT} per tone=+11dBm, ToneSpacing=1MHz

Absolute Maximum Ratings

Parameter	Rating	Unit
Device Current (I_{DQ})	190	mA
Device Voltage (V_D)	6	V
RF Input Power	20	dBm
Junction Temp (T_J)	+150	°C
Operating Temp Range (T_L)	-40 to +85	°C
Storage Temp	+150	°C
Operating Dissipated Power (quiescent)	1.0	W
ESD Rating - Human Body Model (HBM)	Class 2	
Moisture Sensitivity Level	MSL 2	

Operation of this device beyond any one of these limits may cause permanent damage. For reliable continuous operation, the device voltage and current must not exceed the maximum operating values specified in the table on page one.

Bias Conditions should also satisfy the following expression:

$$I_D V_D < (T_J - T_L) / R_{TH}, |J-I| \text{ and } T_L = T_{LEAD}$$



Caution! ESD sensitive device.

Exceeding any one or a combination of the Absolute Maximum Rating conditions may cause permanent damage to the device. Extended application of Absolute Maximum Rating conditions to the device may reduce device reliability. Specified typical performance or functional operation of the device under Absolute Maximum Rating conditions is not implied.

The information in this publication is believed to be accurate and reliable. However, no responsibility is assumed by RF Micro Devices, Inc. ("RFMD") for its use, nor for any infringement of patents, or other rights of third parties, resulting from its use. No license is granted by implication or otherwise under any patent or patent rights of RFMD. RFMD reserves the right to change component circuitry, recommended application circuitry and specifications at any time without prior notice.



RFMD Green: RoHS compliant per EU Directive 2002/95/EC, halogen free per IEC 61249-2-21, < 1000ppm each of antimony trioxide in polymeric materials and red phosphorus as a flame retardant, and <2% antimony in solder.

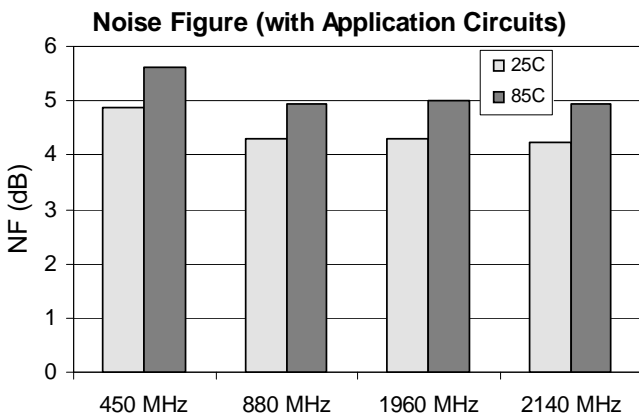
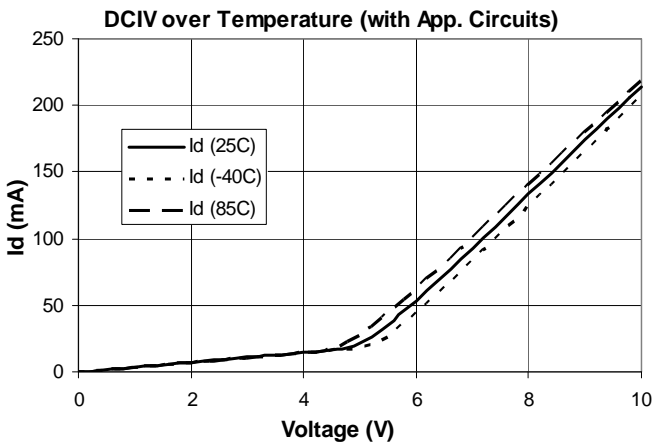

Simplified Device Schematic with ESD diodes

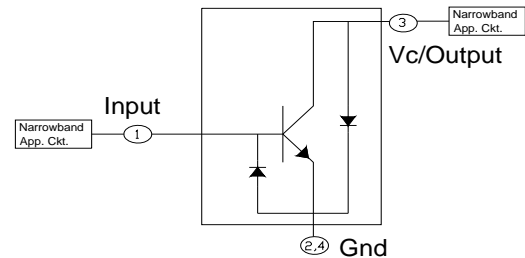

880 MHz Application Circuit Data, $I_D=135mA$, $T=+25C$, $R_{Bias}=20\text{ Ohm}$, $V_S=8V$

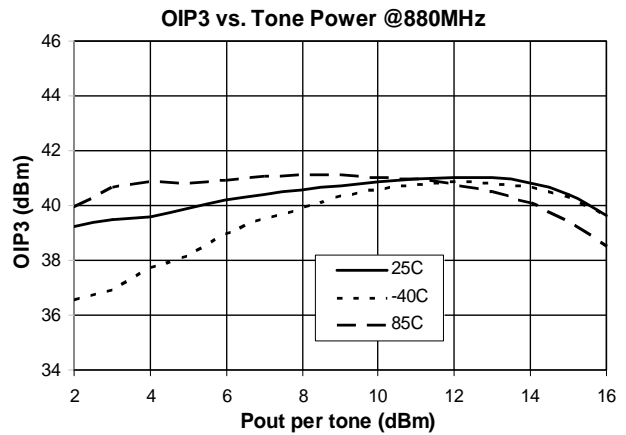
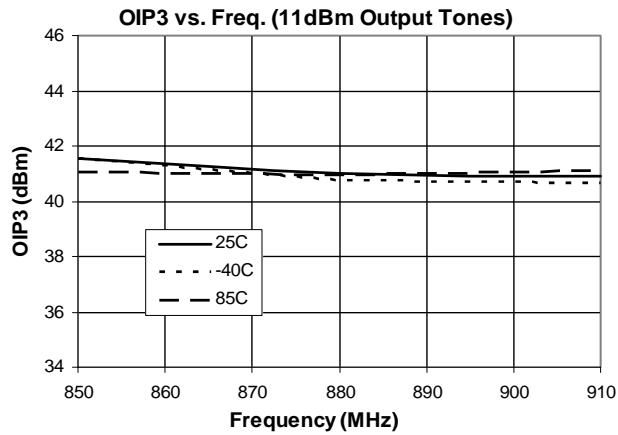
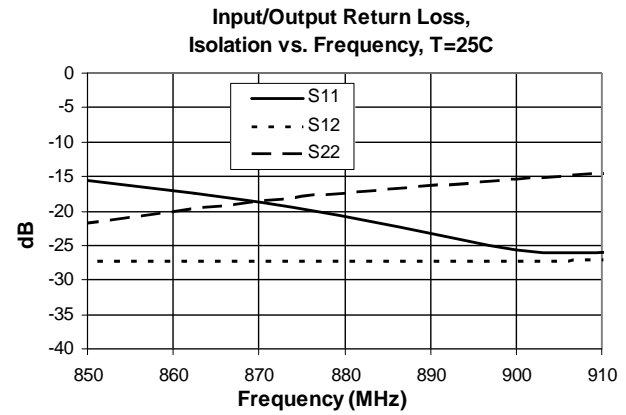
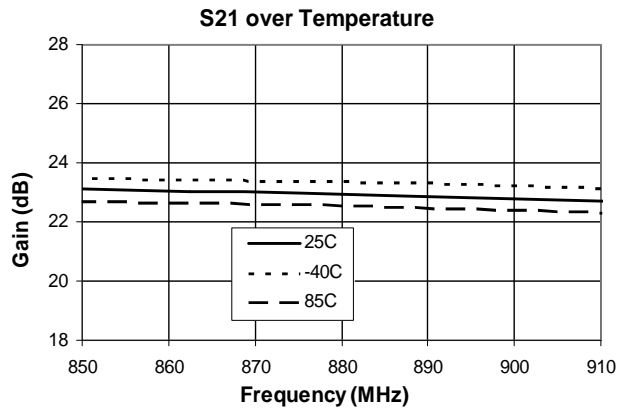
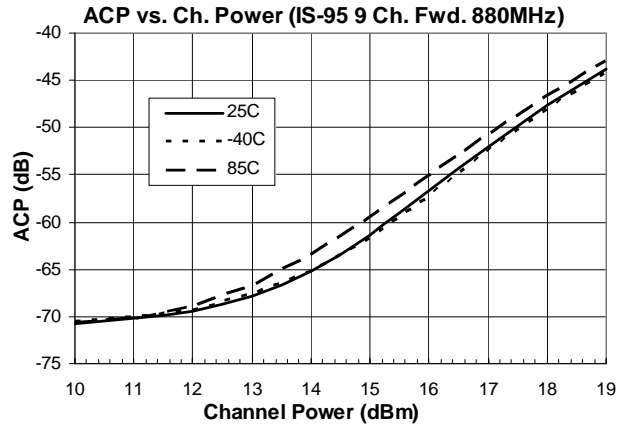
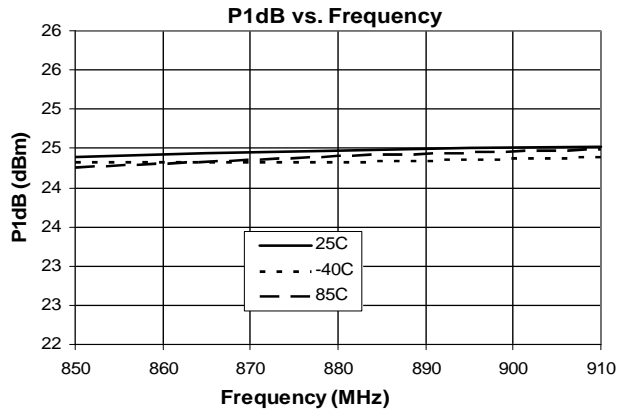

1960 MHz Application Circuit Data, $I_D=135\text{mA}$, $T=+25\text{C}$, $R_{\text{Bias}}=20\ \Omega$, $V_S=8\text{V}$

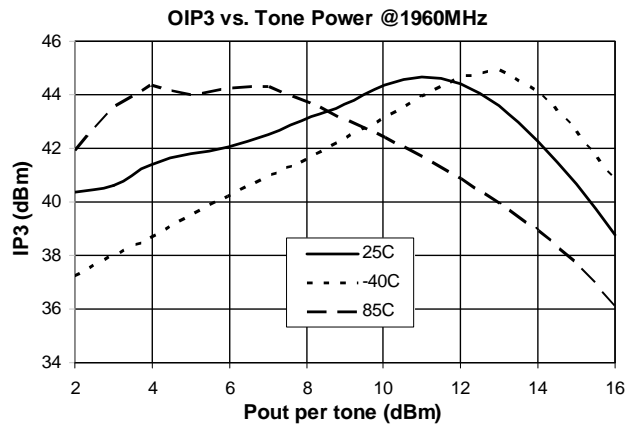
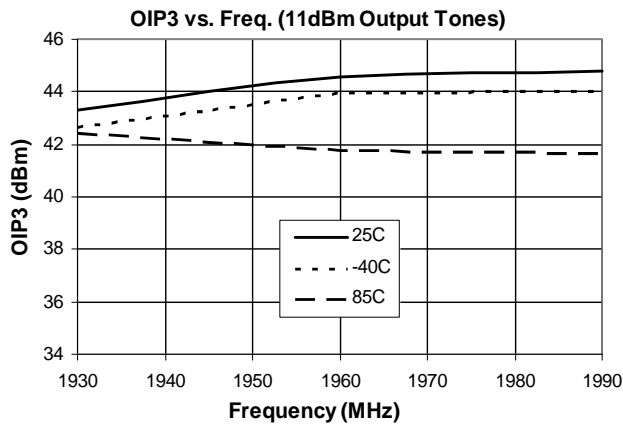
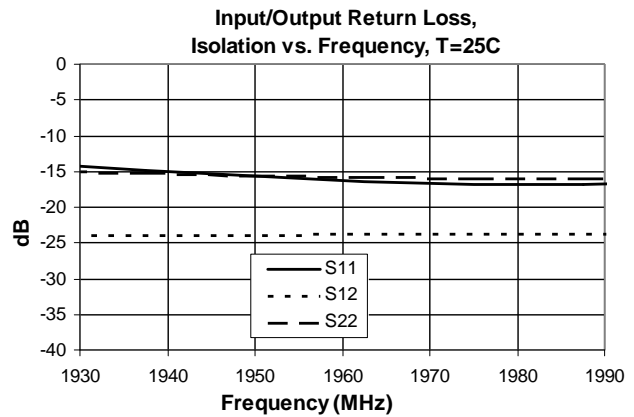
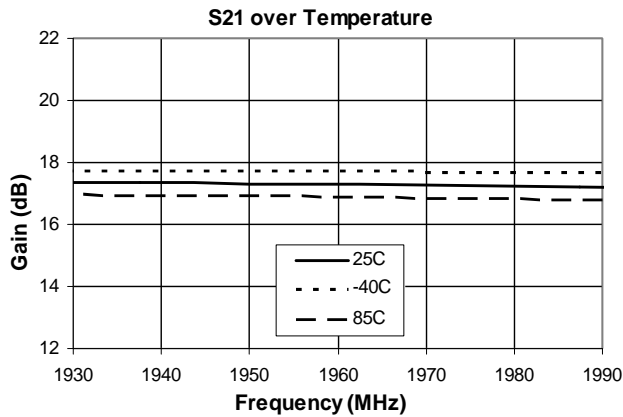
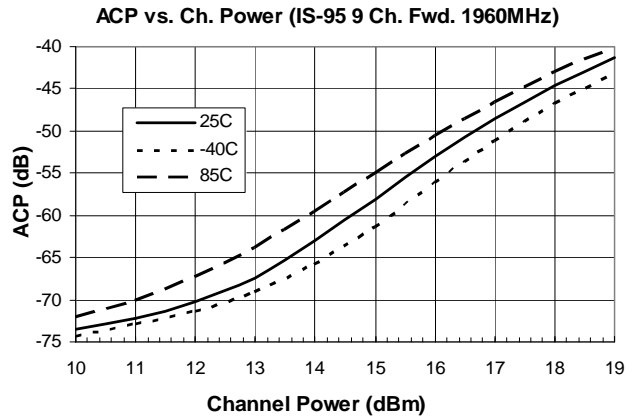
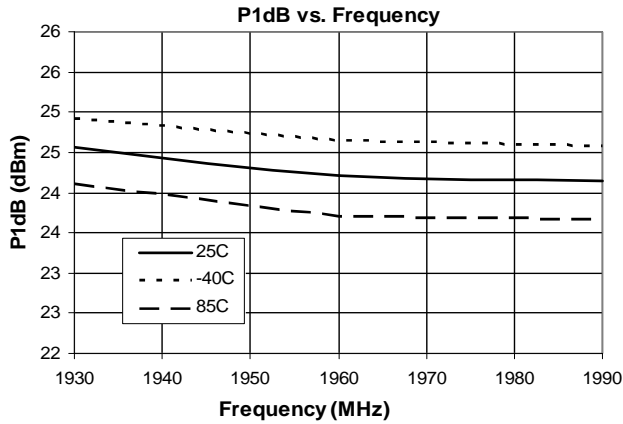

Pin	Function	Description
1	RF IN	RF input pin. This pin requires the use of an external DC blocking capacitor and matching components chosen for the frequency of operation.
2, 4	GND	Connection to ground. Use via holes for best performance to reduce lead inductance as close to ground leads as possible.
3	RF OUT/BIAS	RF output pin. This pin requires the use of an external DC blocking capacitor, choke, and matching components as shown in the Application Schematic.

Suggested Pad Layout

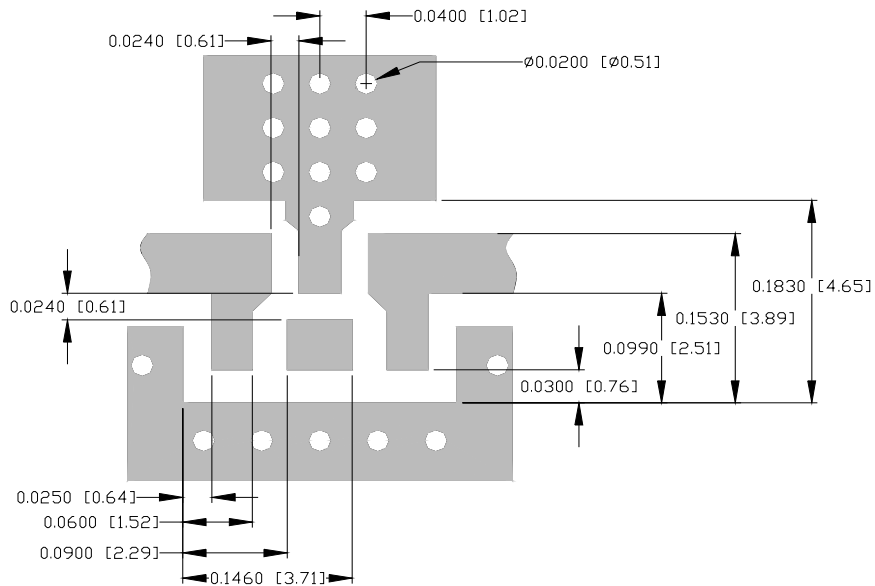

Package Drawing

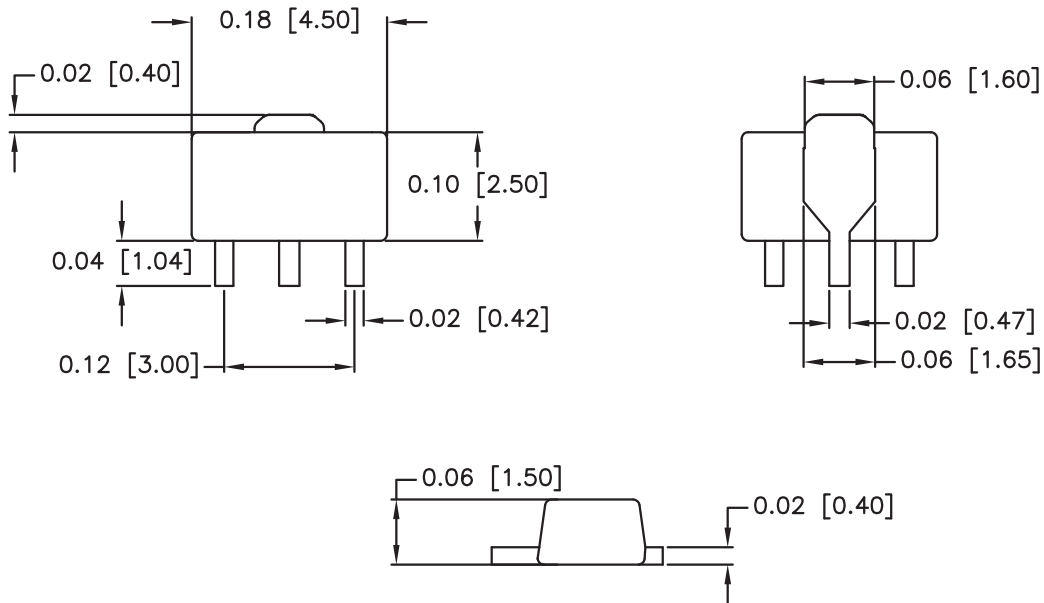

880MHz Application Schematic

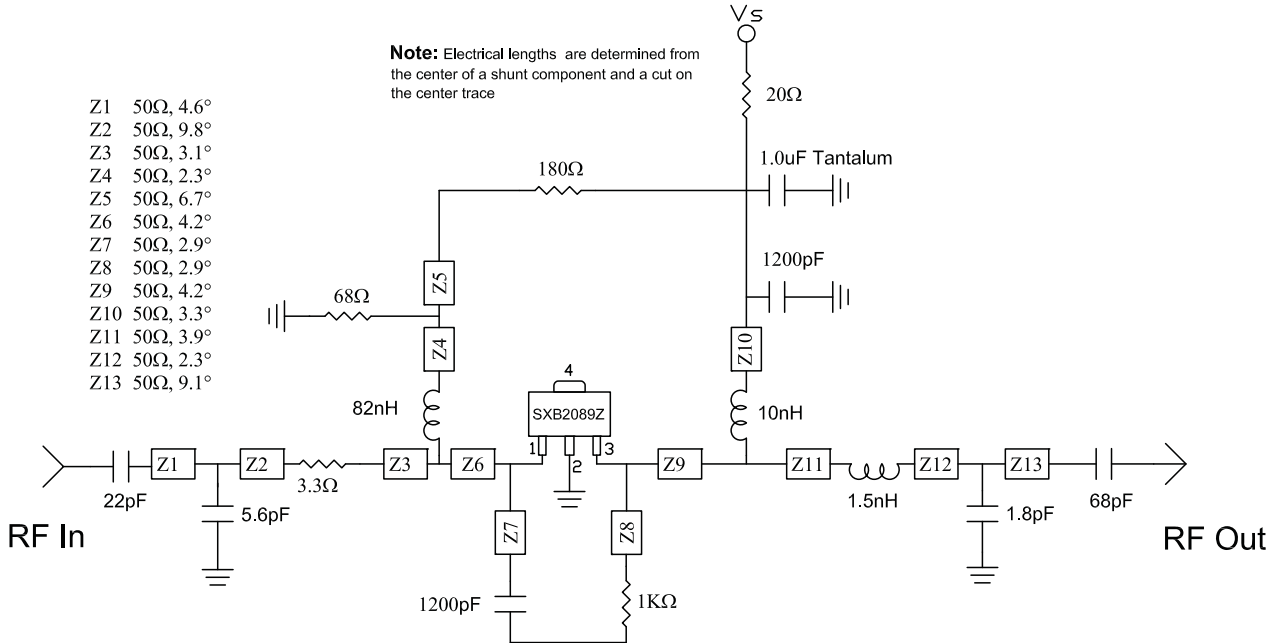

Evaluation Board Layout and Bill of Materials

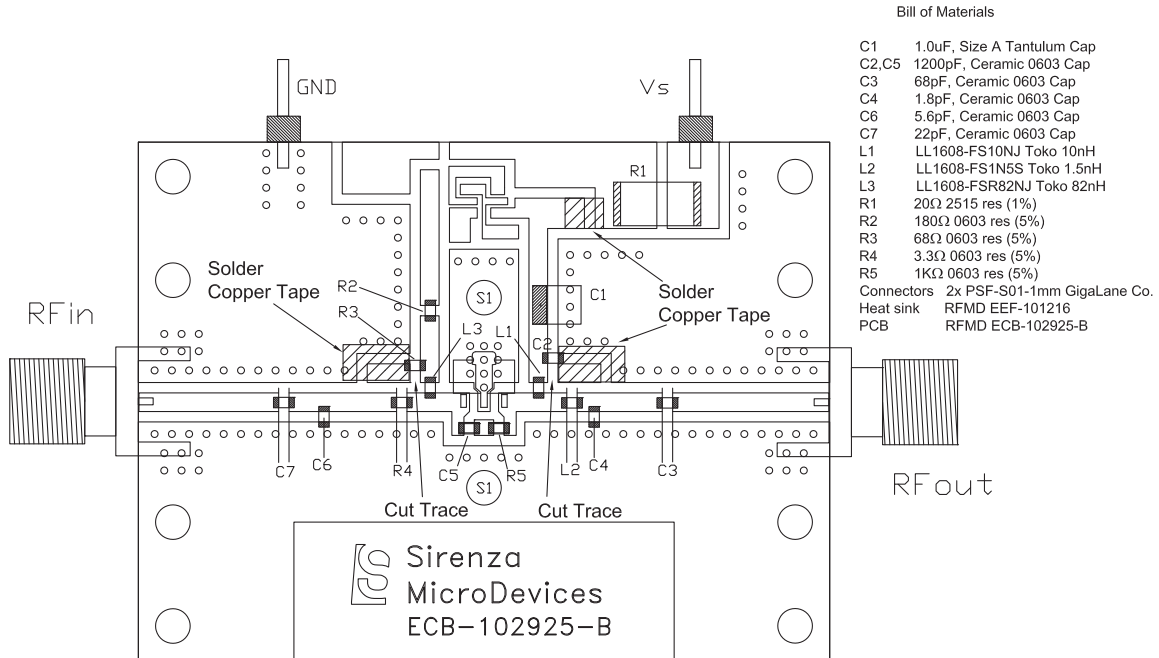

1960MHz Application Schematic

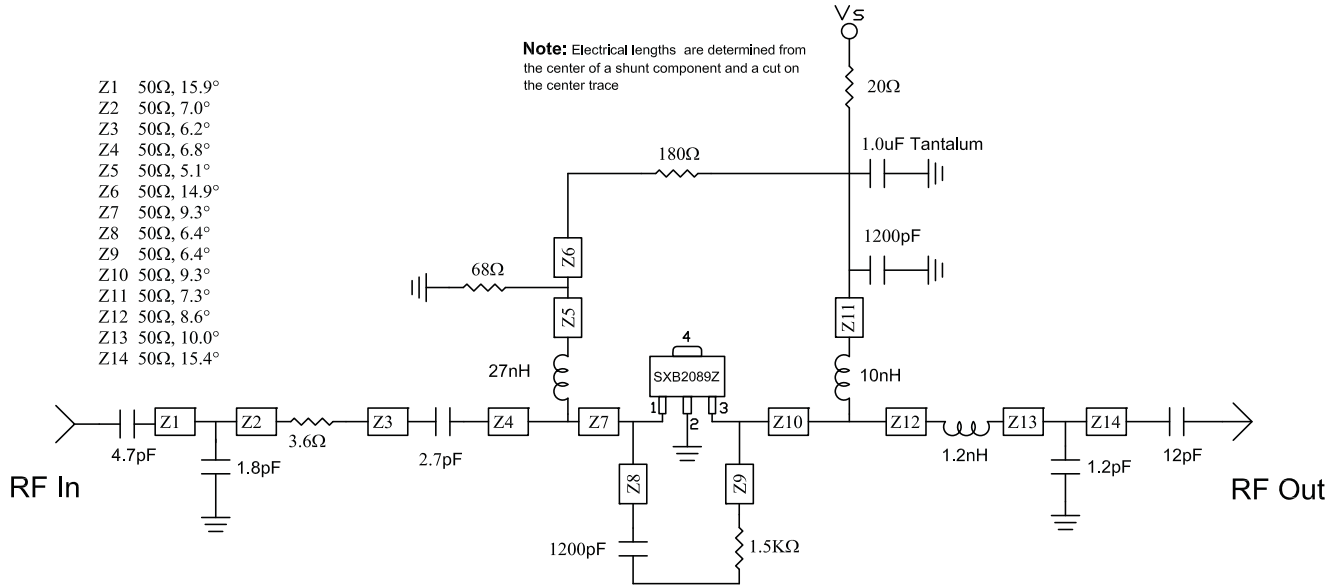

Evaluation Board Layout and Bill of Materials

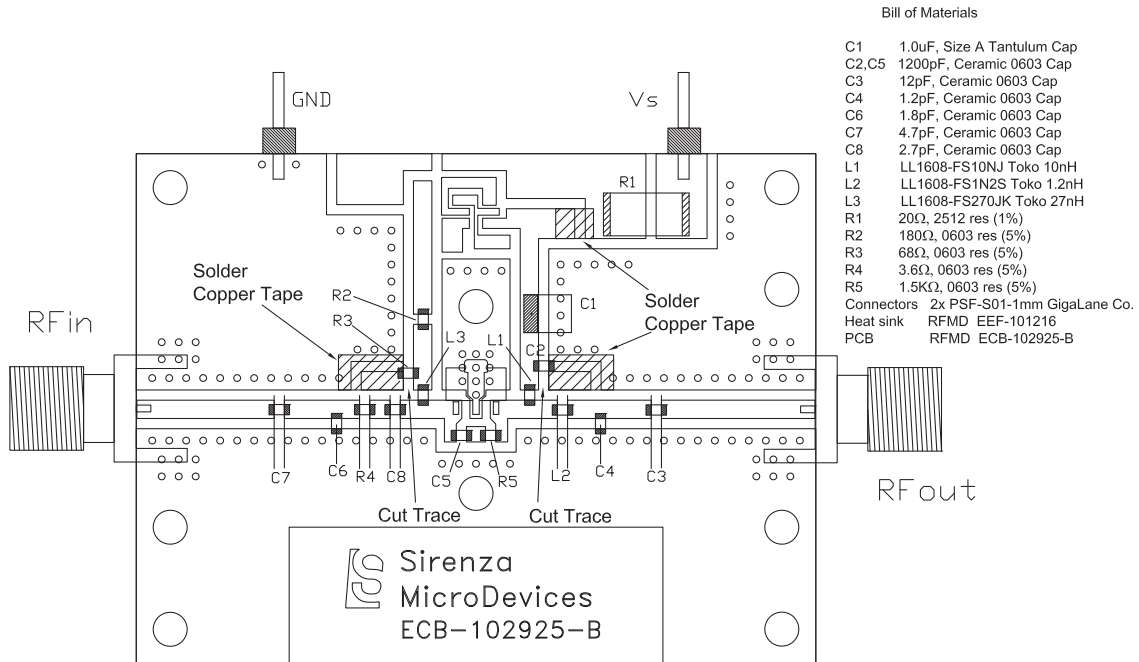

Part Identification

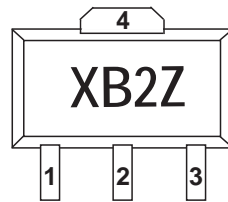

Alternate marking: "SXB2089Z" on line 1 with Trace Code on line 2.

Ordering Information

Ordering Code	Description
SXB2089Z	7" Reel with 1000 pieces
SXB2089ZSQ	Sample Bag with 25 pieces
SXB2089ZSR	7" Reel with 100 pieces
SXB2089Z-EVB1	880MHz, 8V Operation PCBA
SXB2089Z-EVB2	1960MHz, 8V Operation PCBA