

General Description

The AAT3221 and AAT3222 PowerLinear NanoPower low dropout (LDO) linear regulators are ideal for portable applications where extended battery life is critical. These devices feature extremely low quiescent current, typically 1.1µA. Dropout voltage is also very low, typically less than 200mV at the maximum output current of 150mA. The AAT3221/2 have an enable pin feature which, when asserted, will enter the LDO regulator into shutdown mode, removing power from its load and offering extended power conservation capabilities for portable battery-powered applications.

The AAT3221/2 have output short-circuit and over-current protection. In addition, the devices also have an over-temperature protection circuit, which will shut down the LDO regulator during extended over-current events. The devices are available with active high or active low enable input.

The AAT3221 and AAT3222 are available in Pb-free, space-saving 5-pin SOT23 packages. The AAT3221 is also available in a Pb-free, 8-pin SC70JW package. The devices are rated over the -40°C to +85°C temperature range. Since only a small, 1µF ceramic output capacitor is recommended, often the only space used is that occupied by the AAT3221/2 itself. The AAT3221/2 provide a compact and cost-effective voltage conversion solution.

The AAT3221 and AAT3222 are similar to the AAT3220, with the exception that they offer further power savings with an enable pin.

Features

- 1.1µA Quiescent Current
- Low Dropout: 200mV (typical)
- Guaranteed 150mA Output
- High Accuracy: ±2%
- Current Limit Protection
- Over-Temperature Protection
- Extremely Low Power Shutdown Mode
- Low Temperature Coefficient
- Factory-Programmed Output Voltages
 - 1.5V to 3.5V
- Stable Operation With Virtually Any Output Capacitor Type
- Active High or Low Enable Pin
- 4kV ESD
- 5-Pin SOT23 or 8-Pin SC70JW (AAT3221 only) Package
- -40°C to +85°C Temperature Range

Applications

- Cellular Phones
- Digital Cameras
- Handheld Electronics
- Notebook Computers
- PDAs
- Portable Communication Devices
- Remote Controls

Typical Application

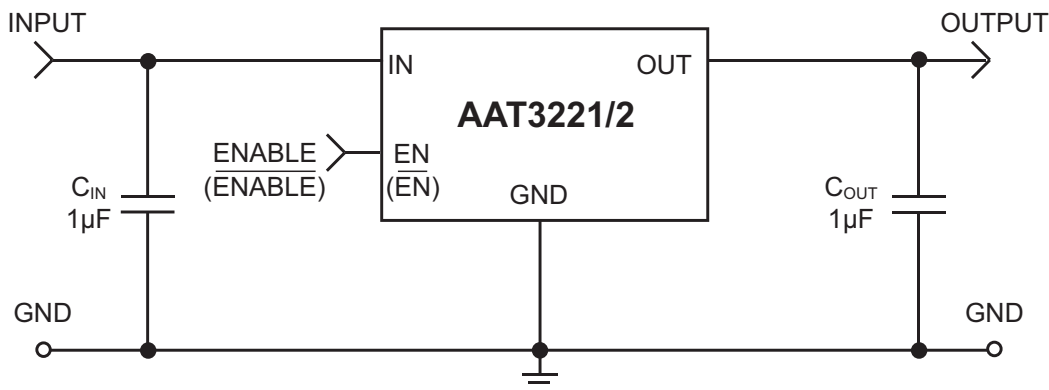

AAT3221/3222*150mA Nanopower™ LDO Linear Regulator***Pin Descriptions**

Pin #		Symbol	Function
AAT3221	AAT3222		
SOT23-5	SC70JW-8		
1	2	IN	Input pin.
2	5, 6, 7, 8	GND	Ground connection pin.
3	4	EN ($\overline{\text{EN}}$)	Enable input. Logic compatible enable with active high or active low option available; see Ordering Information and Applications Information for details.
4	3	NC	Not connected.
5	1	OUT	Output pin; should be decoupled with 1 μ F or greater capacitor.

Pin Configuration

AAT3221
SOT23-5
(Top View)

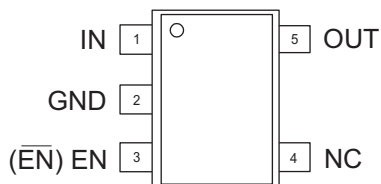

AAT3221
SC70JW-8
(Top View)

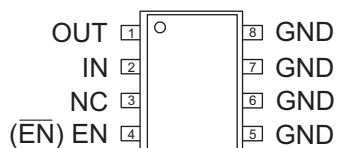

AAT3222
SOT23-5
(Top View)

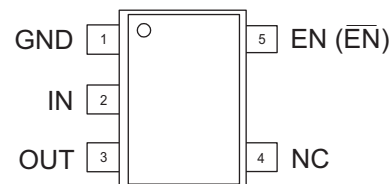

AAT3221/3222**150mA Nanopower™ LDO Linear Regulator****Absolute Maximum Ratings¹**

Symbol	Description	Value	Units
V_{IN}	Input Voltage, <30ms, 10% DC (continuous max = 6.0V)	-0.3 to 7	V
V_{EN}	EN (\overline{EN}) to GND Voltage	-0.3 to 6	
$V_{ENIN(MAX)}$	Maximum EN (\overline{EN}) to Input Voltage	0.3	
I_{OUT}	Maximum DC Output Current	$P_D/(V_{IN}-V_O)$	mA
T_J	Operating Junction Temperature Range	-40 to 150	°C

Thermal Information²

Symbol	Description	Value	Units
Θ_{JA}	Thermal Resistance	SOT23-5	150
		SC70JW-8	160
P_D	Power Dissipation	SOT23-5	667
		SC70JW-8	625

Recommended Operating Conditions

Symbol	Description	Rating	Units
V_{IN}	Input Voltage ³	$(V_{OUT} + V_{DO})$ to 5.5	V
T	Ambient Temperature Range	-40 to +85	°C

1. Stresses above those listed in Absolute Maximum Ratings may cause permanent damage to the device. Functional operation at conditions other than the operating conditions specified is not implied.

2. Mounted on a demo board.

3. To calculate minimum input voltage, use the following equation: $V_{IN(MIN)} = V_{OUT(MAX)} + V_{DO(MAX)}$ as long as $V_{IN} \geq 2.5V$.

AAT3221/3222

150mA Nanopower™ LDO Linear Regulator

Electrical Characteristics

$V_{IN} = V_{OUT(NOM)} + 1V$, $I_{OUT} = 1mA$, $C_{OUT} = 1\mu F$, $T_A = 25^\circ C$, unless otherwise noted.

Symbol	Description	Conditions	Min	Typ	Max	Units
V_{OUT}	DC Output Voltage Tolerance		-2.0		2.0	%
I_{OUT}	Output Current	$V_{OUT} > 1.2V$	150			mA
I_{SC}	Short-Circuit Current	$V_{OUT} < 0.4V$		350		
I_Q	Ground Current	$V_{IN} = 5V$, No Load		1.1	2.5	μA
I_{SD}	Shutdown Current	EN = Inactive		20		nA
$\Delta V_{OUT}/V_{OUT} * \Delta V_{IN}$	Line Regulation	$V_{IN} = 4.0V$ to $5.5V$		0.15	0.4	%/V
$\Delta V_{OUT}/V_{OUT}$	Load Regulation	$I_{OUT} = 1$ to $100mA$	$V_{OUT} = 1.5$	1.3	1.72	%
			$V_{OUT} = 1.6$	1.2	1.69	
			$V_{OUT} = 1.7$	1.1	1.67	
			$V_{OUT} = 1.8$	1.0	1.65	
			$V_{OUT} = 1.9$	1.0	1.62	
			$V_{OUT} = 2.0$	0.9	1.58	
			$V_{OUT} = 2.3$	0.8	1.45	
			$V_{OUT} = 2.4$		1.40	
			$V_{OUT} = 2.5$		1.35	
			$V_{OUT} = 2.6$	0.7	1.30	
			$V_{OUT} = 2.7$		1.25	
			$V_{OUT} = 2.8$		1.20	
			$V_{OUT} = 2.85$		1.20	
			$V_{OUT} = 2.9$		1.18	
			$V_{OUT} = 3.0$	0.6	1.15	
			$V_{OUT} = 3.1$		1.06	
			$V_{OUT} = 3.3$	0.5	1.00	
$V_{OUT} = 3.5$	1.00					
V_{DO}	Dropout Voltage ^{1, 2}	$I_{OUT} = 100mA$	$V_{OUT} = 2.3$	230	275	mV
			$V_{OUT} = 2.4$	220	265	
			$V_{OUT} = 2.5$	210	255	
			$V_{OUT} = 2.6$	205	247	
			$V_{OUT} = 2.7$	200	240	
			$V_{OUT} = 2.8$	190	235	
			$V_{OUT} = 2.85$		230	
			$V_{OUT} = 2.9$		228	
			$V_{OUT} = 3.0$	188	225	
			$V_{OUT} = 3.1$		222	
			$V_{OUT} = 3.3$	180	220	
$V_{OUT} = 3.5$	220					
$V_{EN(L)}$	EN Input Low Voltage				0.8	V
$V_{EN(H)}$	EN Input High Voltage	$V_{IN} = 2.7V$ to $3.6V$	2.0			
		$V_{IN} = 5V$	2.4			
$I_{EN(SINK)}$	EN Input Leakage	$V_{ON} = 5.5V$		0.01	1	μA
PSRR	Power Supply Rejection Ratio	100Hz		50		dB
T_{SD}	Over-Temperature Shutdown Threshold			140		$^\circ C$
T_{HYS}	Over-Temperature Shutdown Hysteresis			20		
e_N	Output Noise			350		μV_{RMS}
T_C	Output Voltage Temperature Coefficient			80		PPM/ $^\circ C$

1. V_{DO} is defined as $V_{IN} - V_{OUT}$ when V_{OUT} is 98% of nominal.

2. For $V_{OUT} < 2.3V$, $V_{DO} = 2.5V - V_{OUT}$.

AAT3221/3222

150mA Nanopower™ LDO Linear Regulator

Typical Characteristics

Unless otherwise noted, $V_{IN} = V_{OUT} + 1V$, $T_A = 25^\circ C$, $C_{OUT} = 5.6\mu F$ Ceramic, $I_{OUT} = 100mA$.

Output Voltage vs. Output Current

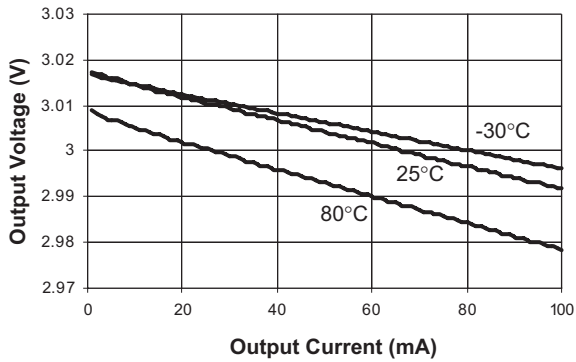

Output Voltage vs. Input Voltage

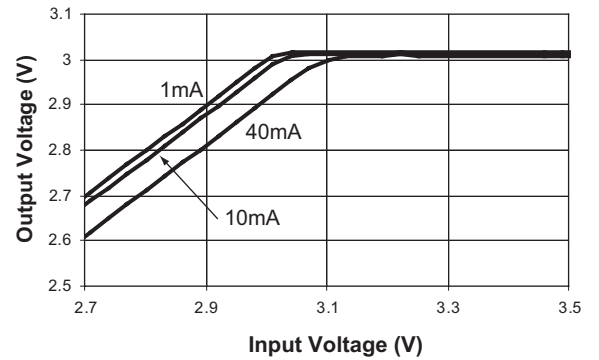

Output Voltage vs. Input Voltage

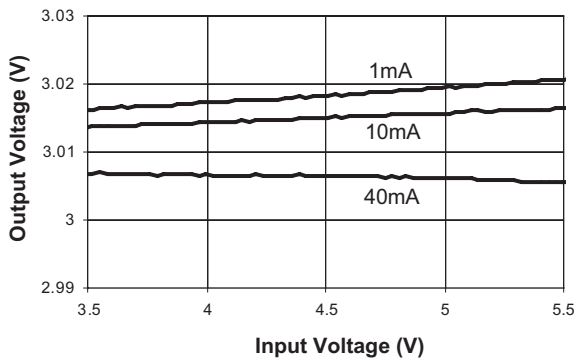

Dropout Voltage vs. Output Current

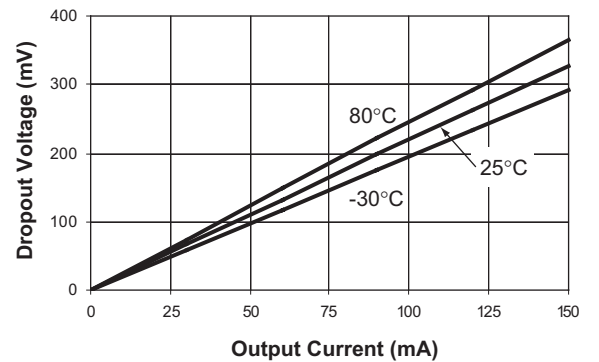

Supply Current vs. Input Voltage

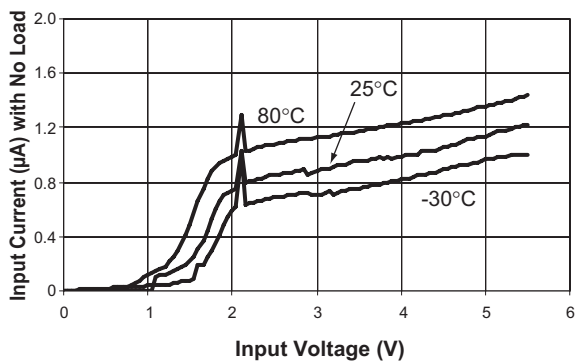

PSRR with 10mA Load

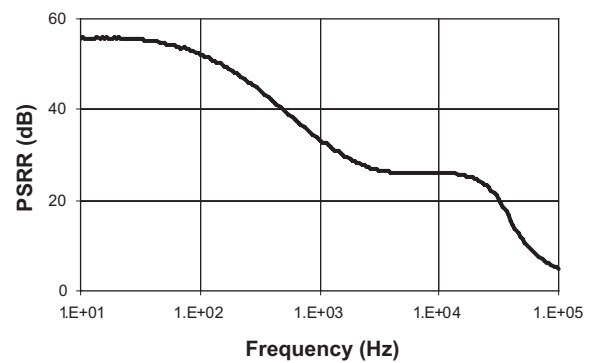

AAT3221/3222

150mA Nanopower™ LDO Linear Regulator

Typical Characteristics

Unless otherwise noted, $V_{IN} = V_{OUT} + 1V$, $T_A = 25^\circ C$, $C_{OUT} = 5.6\mu F$ Ceramic, $I_{OUT} = 100mA$.

Noise Spectrum

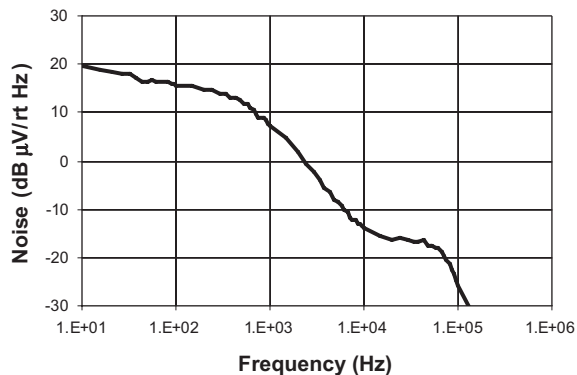

Line Response with 1mA Load

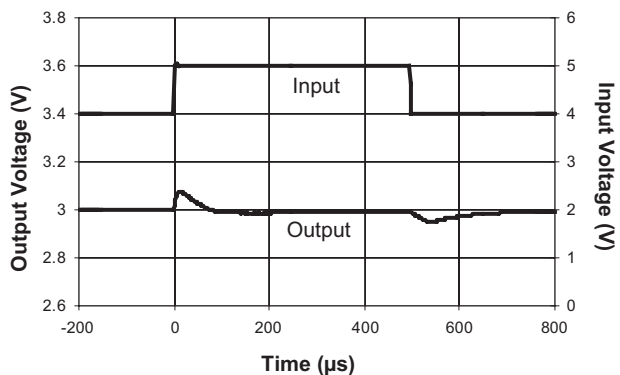

Line Response with 10mA Load

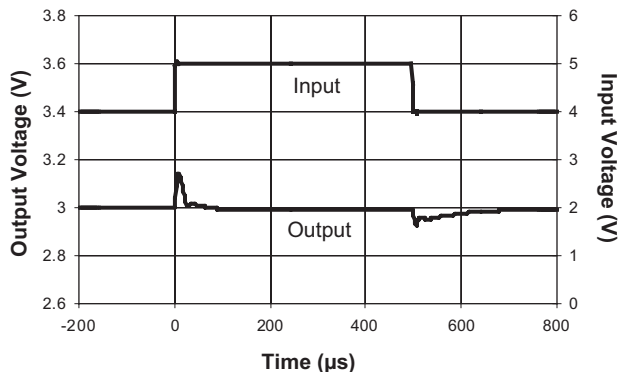

Line Response with 100mA Load

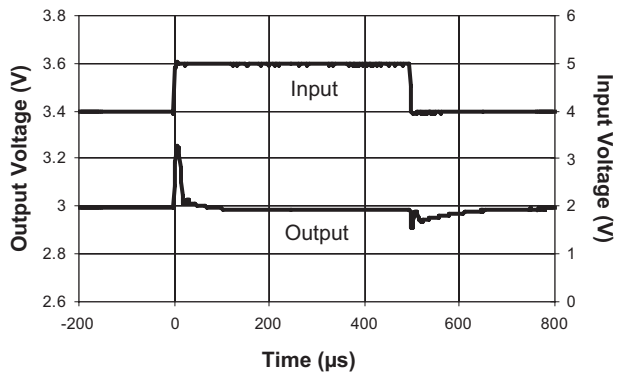

Load Transient - 1mA / 40mA

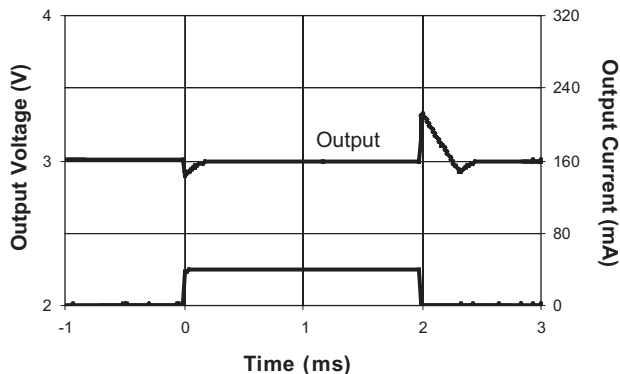

Load Transient - 1mA / 80mA

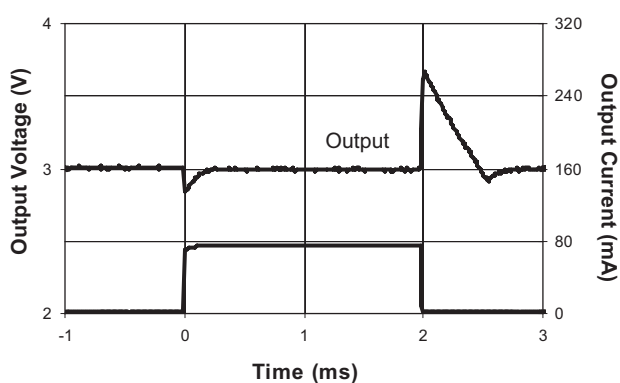

AAT3221/3222

150mA Nanopower™ LDO Linear Regulator

Typical Characteristics

Unless otherwise noted, $V_{IN} = V_{OUT} + 1V$, $T_A = 25^\circ C$, $C_{OUT} = 5.6\mu F$ Ceramic, $I_{OUT} = 100mA$.

Power-Up with 1mA Load

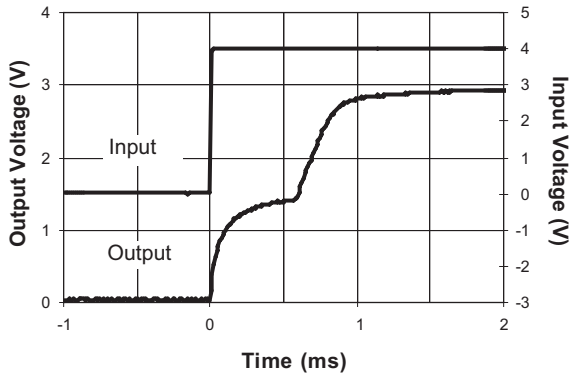

Turn-On with 1mA Load

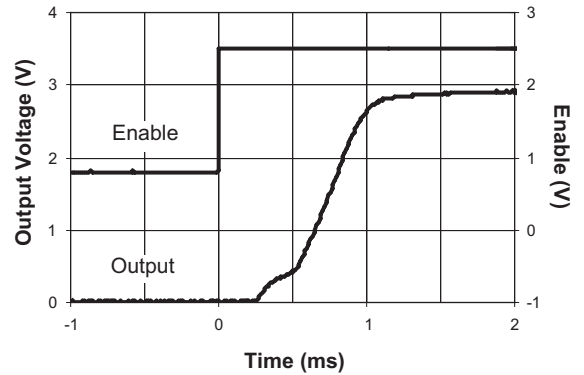

Power-Up with 10mA Load

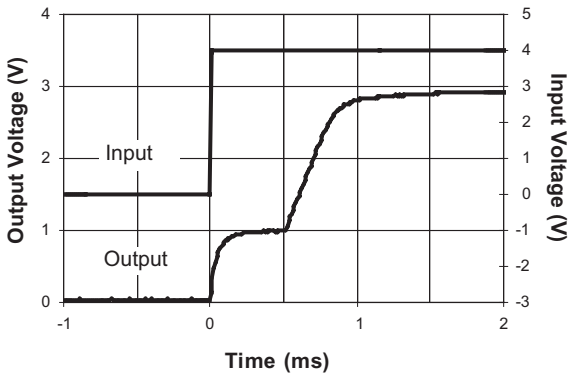

Turn-On with 10mA Load

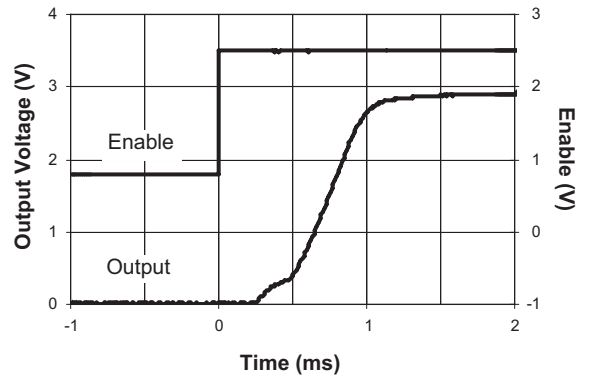

Power-Up with 100mA Load

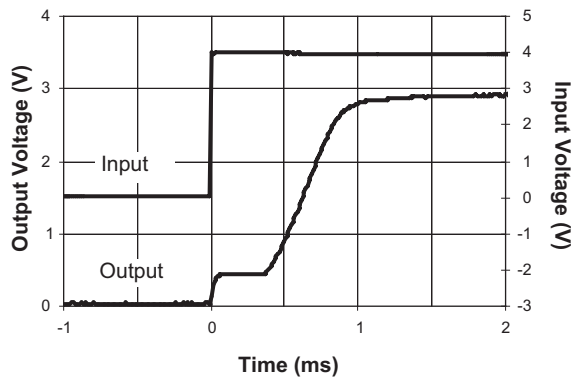

Turn-On with 100mA Load

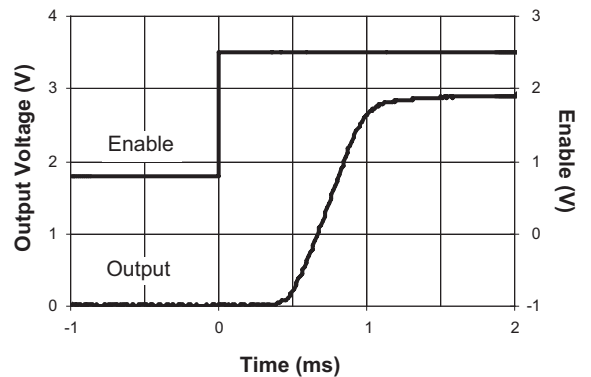

AAT3221/3222

150mA Nanopower™ LDO Linear Regulator

Functional Block Diagram

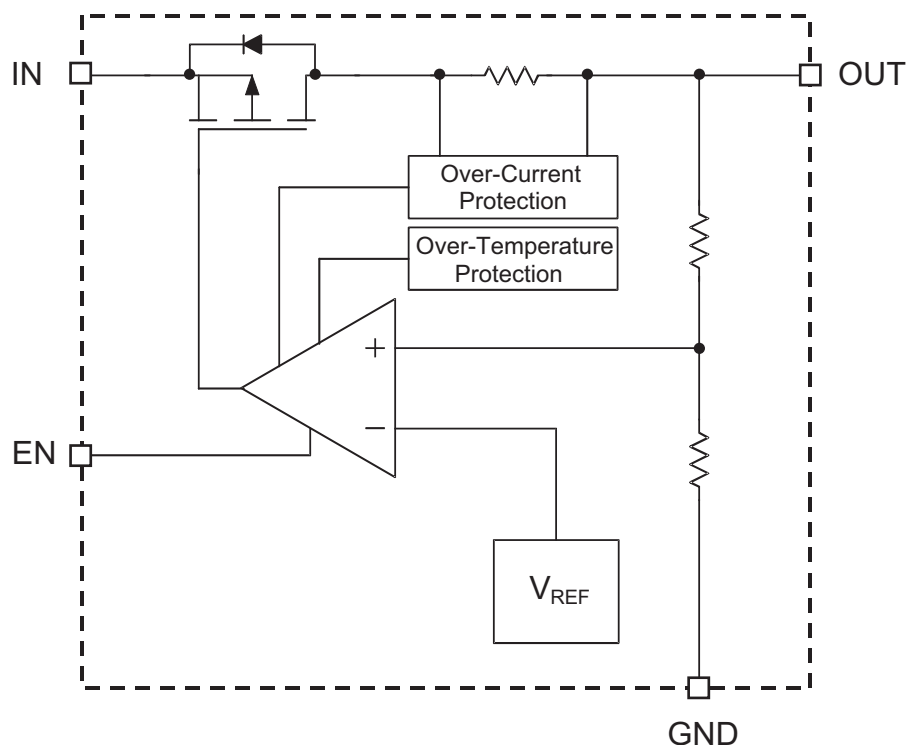

Functional Description

The AAT3221 and AAT3222 are intended for LDO regulator applications where output current load requirements range from no load to 150mA. The advanced circuit design of the AAT3221/2 has been optimized for very low quiescent or ground current consumption, making it ideal for use in power management systems for small battery-operated devices. The typical quiescent current level is just 1.1 μ A. AAT3221/2 devices also contain an enable circuit which has been provided to shut down the LDO regulator for additional power conservation in portable products. In the shutdown state, the LDO draws less than 1 μ A from input supply.

The LDO also demonstrates excellent power supply ripple rejection (PSRR) and load and line transient response characteristics. The AAT3221/2 high performance LDO

regulators are especially well suited for circuit applications that are sensitive to load circuit power consumption and extended battery life.

The LDO regulator output has been specifically optimized to function with low-cost, low-ESR ceramic capacitors. However, the design will allow for operation with a wide range of capacitor types.

The AAT3221/2 have complete short-circuit and thermal protection. The integral combination of these two internal protection circuits gives the AAT3221/2 a comprehensive safety system to guard against extreme adverse operating conditions. Device power dissipation is limited to the package type and thermal dissipation properties. Refer to the Thermal Considerations section of this document for details on device operation at maximum output load levels.

AAT3221/3222

150mA Nanopower™ LDO Linear Regulator

Applications Information

To ensure that the maximum possible performance is obtained from the AAT3221/2, please refer to the following application recommendations.

Input Capacitor

A 1 μ F or larger capacitor is typically recommended for C_{IN} in most applications. A C_{IN} capacitor is not required for basic LDO regulator operation. However, if the AAT3221/2 are physically located any distance more than one or two centimeters from the input power source, a C_{IN} capacitor will be needed for stable operation. C_{IN} should be located as closely to the device V_{IN} pin as practically possible. C_{IN} values greater than 1 μ F will offer superior input line transient response and will assist in maximizing the power supply ripple rejection.

Ceramic, tantalum, or aluminum electrolytic capacitors may be selected for C_{IN}, as there is no specific capacitor ESR requirement. For 150mA LDO regulator output operation, ceramic capacitors are recommended for C_{IN} due to their inherent capability over tantalum capacitors to withstand input current surges from low impedance sources such as batteries in portable devices.

Output Capacitor

For proper load voltage regulation and operational stability, a capacitor is required between pins V_{OUT} and GND. The C_{OUT} capacitor connection to the LDO regulator ground pin should be made as direct as practically possible for maximum device performance. The AAT3221/2 have been specifically designed to function with very low ESR ceramic capacitors. Although the device is intended to operate with these low ESR capacitors, it is stable over a wide range of capacitor ESR, thus it will also work with some higher ESR tantalum or aluminum electrolytic capacitors. However, for best performance, ceramic capacitors are recommended.

The value of C_{OUT} typically ranges from 0.47 μ F to 10 μ F; however, 1 μ F is sufficient for most operating conditions.

If large output current steps are required by an application, then an increased value for C_{OUT} should be considered. The amount of capacitance needed can be calculated from the step size of the change in output load current expected and the voltage excursion that the load can tolerate.

The total output capacitance required can be calculated using the following formula:

$$C_{OUT} = \frac{\Delta I}{\Delta V} \cdot 15\mu F$$

Where:

ΔI = maximum step in output current

ΔV = maximum excursion in voltage that the load can tolerate

Note that use of this equation results in capacitor values approximately two to four times the typical value needed for an AAT3221/2 at room temperature. The increased capacitor value is recommended if tight output tolerances must be maintained over extreme operating conditions and maximum operational temperature excursions. If tantalum or aluminum electrolytic capacitors are used, the capacitor value should be increased to compensate for the substantial ESR inherent to these capacitor types.

Capacitor Characteristics

Ceramic composition capacitors are highly recommended over all other types of capacitors for use with the AAT3221/2. Ceramic capacitors offer many advantages over their tantalum and aluminum electrolytic counterparts. A ceramic capacitor typically has very low ESR, is lower cost, has a smaller PCB footprint, and is non-polarized. Line and load transient response of the LDO regulator is improved by using low-ESR ceramic capacitors. Since ceramic capacitors are non-polarized, they are less prone to damage if incorrectly connected.

Equivalent Series Resistance (ESR)

ESR is a very important characteristic to consider when selecting a capacitor. ESR is the internal series resistance associated with a capacitor, which includes lead resistance, internal connections, capacitor size and area, material composition, and ambient temperature. Typically, capacitor ESR is measured in milliohms for ceramic capacitors and can range to more than several ohms for tantalum or aluminum electrolytic capacitors.

Ceramic Capacitor Materials

Ceramic capacitors less than 0.1 μ F are typically made from NPO or COG materials. NPO and COG materials are typically tight tolerance and very stable over temperature. Larger capacitor values are typically composed of

AAT3221/3222

150mA Nanopower™ LDO Linear Regulator

X7R, X5R, Z5U, and Y5V dielectric materials. Large ceramic capacitors, typically greater than 2.2μF, are often available in low-cost Y5V and Z5U dielectrics. These two material types are not recommended for use with LDO regulators since the capacitor tolerance can vary more than ±50% over the operating temperature range of the device. A 2.2μF Y5V capacitor could be reduced to 1μF over the full operating temperature range. This can cause problems for circuit operation and stability. X7R and X5R dielectrics are much more desirable. The temperature tolerance of X7R dielectric is better than ±15%.

Capacitor area is another contributor to ESR. Capacitors that are physically large in size will have a lower ESR when compared to a smaller sized capacitor of equivalent material and capacitance value. These larger devices can also improve circuit transient response when compared to an equal value capacitor in a smaller package size.

Consult capacitor vendor datasheets carefully when selecting capacitors for use with LDO regulators.

Enable Function

The AAT3221/2 features an LDO regulator enable / disable function. This pin (EN) is compatible with CMOS logic. Active high or active low options are available (see Ordering Information). For a logic high signal, the EN control level must be greater than 2.4 volts. A logic low signal is asserted when the voltage on the EN pin falls below 0.8 volts. For example, the active high version AAT3221/2 will turn on when a logic high is applied to the EN pin. If the enable function is not needed in a specific application, it may be tied to the respective voltage level to keep the LDO regulator in a continuously on state; e.g., the active high version AAT3221/2 will tie V_{IN} to EN to remain on.

Short-Circuit Protection and Thermal Protection

The AAT3221/2 is protected by both current limit and over-temperature protection circuitry. The internal short-circuit current limit is designed to activate when the output load demand exceeds the maximum rated output. If a short-circuit condition were to continually draw more than the current limit threshold, the LDO regulator's output voltage will drop to a level necessary to supply the current demanded by the load. Under short-circuit or other over-current operating conditions, the output voltage will drop and the AAT3221/2 die temperature will

rapidly increase. Once the regulator's power dissipation capacity has been exceeded and the internal die temperature reaches approximately 140°C, the system thermal protection circuit will become active. The internal thermal protection circuit will actively turn off the LDO regulator output pass device to prevent the possibility of over-temperature damage. The LDO regulator output will remain in a shutdown state until the internal die temperature falls back below the 140°C trip point.

The interaction between the short-circuit and thermal protection systems allows the LDO regulator to withstand indefinite short-circuit conditions without sustaining permanent damage.

No-Load Stability

The AAT3221/2 are designed to maintain output voltage regulation and stability under operational no-load conditions. This is an important characteristic for applications where the output current may drop to zero. An output capacitor is required for stability under no-load operating conditions. Refer to the output capacitor considerations section of this document for recommended typical output capacitor values.

Thermal Considerations and High Output Current Applications

The AAT3221/2 are designed to deliver a continuous output load current of 150mA under normal operating conditions. The limiting characteristic for the maximum output load safe operating area is essentially package power dissipation and the internal preset thermal limit of the device. In order to obtain high operating currents, careful device layout and circuit operating conditions need to be taken into account. The following discussions will assume the LDO regulator is mounted on a printed circuit board utilizing the minimum recommended footprint and the printed circuit board is 0.062-inch thick FR4 material with one ounce copper.

At any given ambient temperature (T_A), the maximum package power dissipation can be determined by the following equation:

$$P_{D(MAX)} = \frac{T_{J(MAX)} - T_A}{\Theta_{JA}}$$

Constants for the AAT3221/2 are $T_{J(MAX)}$, the maximum junction temperature for the device which is 125°C and $\Theta_{JA} = 150^\circ\text{C/W}$, the package thermal resistance. Typically,

AAT3221/3222

150mA Nanopower™ LDO Linear Regulator

maximum conditions are calculated at the maximum operating temperature where $T_A = 85^\circ\text{C}$, under normal ambient conditions $T_A = 25^\circ\text{C}$. Given $T_A = 85^\circ\text{C}$, the maximum package power dissipation is 267mW. At $T_A = 25^\circ\text{C}$, the maximum package power dissipation is 667mW.

The maximum continuous output current for the AAT3221/2 is a function of the package power dissipation and the input-to-output voltage drop across the LDO regulator. Refer to the following simple equation:

$$I_{\text{OUT(MAX)}} = \frac{P_{\text{D(MAX)}}}{(V_{\text{IN}} - V_{\text{OUT}})}$$

For example, if $V_{\text{IN}} = 5\text{V}$, $V_{\text{OUT}} = 2.5\text{V}$ and $T_A = 25^\circ\text{C}$, $I_{\text{OUT(MAX)}} < 267\text{mA}$. The output short-circuit protection threshold is set between 150mA and 300mA. If the output load current were to exceed 267mA or if the ambient temperature were to increase, the internal die temperature would increase. If the condition remained constant and the short-circuit protection did not activate, there would be a potential damage hazard to the LDO regulator since the thermal protection circuit would only activate after a short-circuit event occurred on the LDO regulator output.

To determine the maximum input voltage for a given load current, refer to the following equation. This calculation accounts for the total power dissipation of the LDO regulator, including that caused by ground current.

$$P_{\text{D(MAX)}} = (V_{\text{IN}} - V_{\text{OUT}}) \cdot I_{\text{OUT}} + (V_{\text{IN}} \cdot I_{\text{GND}})$$

This formula can be solved for V_{IN} to determine the maximum input voltage.

$$V_{\text{IN(MAX)}} = \frac{P_{\text{D(MAX)}} + (V_{\text{OUT}} \cdot I_{\text{OUT}})}{I_{\text{OUT}} + I_{\text{GND}}}$$

The following is an example for an AAT3221/2 set for a 2.5 volt output:

$$\begin{aligned} V_{\text{OUT}} &= 2.5 \text{ volts} \\ I_{\text{OUT}} &= 150 \text{ mA} \\ I_{\text{GND}} &= 1.1 \mu\text{A} \end{aligned}$$

$$\begin{aligned} V_{\text{IN(MAX)}} &= \frac{667\text{mW} + (2.5\text{V} \cdot 150\text{mA})}{150\text{mA} + 1.1\mu\text{A}} \\ &= 6.95\text{V} \end{aligned}$$

From the discussion above, $P_{\text{D(MAX)}}$ was determined to equal 667mW at $T_A = 25^\circ\text{C}$. Thus, the AAT3221/2 can sustain a constant 2.5V output at a 150mA load current as long as V_{IN} is $\leq 6.95\text{V}$ at an ambient temperature of 25°C . 5.5V is the maximum input operating voltage for the AAT3221/2, thus at 25°C the device would not have any thermal concerns or operational $V_{\text{IN(MAX)}}$ limits.

This situation can be different at 85°C . The following is an example for an AAT3221/2 set for a 2.5 volt output at 85°C :

$$\begin{aligned} V_{\text{OUT}} &= 2.5 \text{ volts} \\ I_{\text{OUT}} &= 150 \text{ mA} \\ I_{\text{GND}} &= 1.1 \mu\text{A} \end{aligned}$$

$$V_{\text{IN(MAX)}} = \frac{267\text{mW} + (2.5\text{V} \cdot 150\text{mA})}{(150\text{mA} + 1.1\mu\text{A})}$$

$$V_{\text{IN(MAX)}} = 4.28\text{V}$$

From the discussion above, $P_{\text{D(MAX)}}$ was determined to equal 267mW at $T_A = 85^\circ\text{C}$.

Higher input-to-output voltage differentials can be obtained with the AAT3221/2, while maintaining device functions in the thermal safe operating area. To accomplish this, the device thermal resistance must be reduced by increasing the heat sink area or by operating the LDO regulator in a duty-cycled mode.

For example, an application requires $V_{\text{IN}} = 5.0\text{V}$ while $V_{\text{OUT}} = 2.5\text{V}$ at a 150mA load and $T_A = 85^\circ\text{C}$. V_{IN} is greater than 4.28V, which is the maximum safe continuous input level for $V_{\text{OUT}} = 2.5\text{V}$ at 150mA for $T_A = 85^\circ\text{C}$. To maintain this high input voltage and output current level, the LDO regulator must be operated in a duty-cycled mode. Refer to the following calculation for duty-cycle operation:

$$\begin{aligned} I_{\text{GND}} &= 1.1 \mu\text{A} \\ I_{\text{OUT}} &= 150 \text{ mA} \\ V_{\text{IN}} &= 5.0 \text{ volts} \\ V_{\text{OUT}} &= 2.5 \text{ volts} \end{aligned}$$

$$\%DC = \frac{P_{\text{D(MAX)}}}{(V_{\text{IN}} - V_{\text{OUT}}) \cdot I_{\text{OUT}} + (V_{\text{IN}} \cdot I_{\text{GND}})}$$

$$\%DC = \frac{267\text{mW}}{(5.0\text{V} - 2.5\text{V}) \cdot 150\text{mA} + (5.0\text{V} \cdot 1.1\mu\text{A})}$$

$$\%DC = 71.2\%$$

$P_{\text{D(MAX)}}$ is assumed to be 267mW.

AAT3221/3222

150mA Nanopower™ LDO Linear Regulator

For a 150mA output current and a 2.5 volt drop across the AAT3221/2 at an ambient temperature of 85°C, the maximum on-time duty cycle for the device would be 71.2%.

The following family of curves shows the safe operating area for duty-cycled operation from ambient room temperature to the maximum operating level.

Device Duty Cycle vs. V_{DROD}
($V_{OUT} = 2.5V @ 25^{\circ}C$)

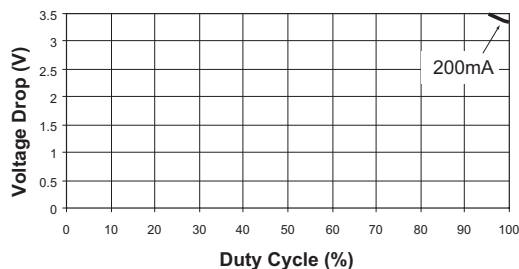

Device Duty Cycle vs. V_{DROD}
($V_{OUT} = 2.5V @ 50^{\circ}C$)

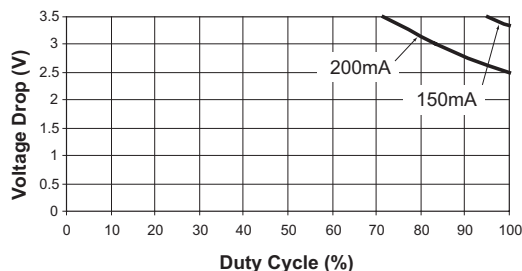

Device Duty Cycle vs. V_{DROD}
($V_{OUT} = 2.5V @ 85^{\circ}C$)

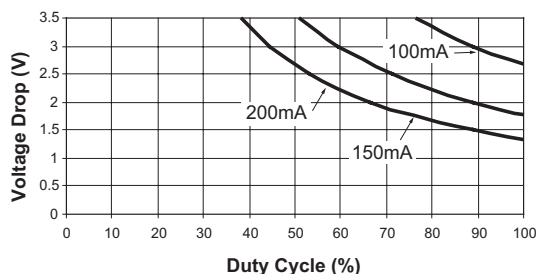

High Peak Output Current Applications

Some applications require the LDO regulator to operate at continuous nominal levels with short duration, high-current peaks. The duty cycles for both output current levels must be taken into account. To do so, one would first need to calculate the power dissipation at the nominal continuous level, then factor in the addition power dissipation due to the short duration, high-current peaks.

For example, a 2.5V system using an AAT3221/2IGV-2.5-T1 operates at a continuous 100mA load current level and has short 150mA current peaks. The current peak occurs for 378 μ s out of a 4.61ms period. It will be assumed the input voltage is 5.0V.

First, the current duty cycle percentage must be calculated:

$$\begin{aligned} \% \text{ Peak Duty Cycle: } X/100 &= 378\text{ms}/4.61\text{ms} \\ \% \text{ Peak Duty Cycle} &= 8.2\% \end{aligned}$$

The LDO regulator will be under the 100mA load for 91.8% of the 4.61ms period and have 150mA peaks occurring for 8.2% of the time. Next, the continuous nominal power dissipation for the 100mA load should be determined then multiplied by the duty cycle to conclude the actual power dissipation over time.

$$\begin{aligned} P_{D(\text{MAX})} &= (V_{IN} - V_{OUT})I_{OUT} + (V_{IN} \cdot I_{GND}) \\ P_{D(100\text{mA})} &= (5.0V - 2.5V)100\text{mA} + (5.0V \cdot 1.1\mu\text{A}) \\ P_{D(100\text{mA})} &= 250\text{mW} \end{aligned}$$

$$\begin{aligned} P_{D(91.8\%D/C)} &= \%DC \cdot P_{D(100\text{mA})} \\ P_{D(91.8\%D/C)} &= 0.918 \cdot 250\text{mW} \\ P_{D(91.8\%D/C)} &= 229.5\text{mW} \end{aligned}$$

The power dissipation for a 100mA load occurring for 91.8% of the duty cycle will be 229.5mW. Now the power dissipation for the remaining 8.2% of the duty cycle at the 150mA load can be calculated:

$$\begin{aligned} P_{D(\text{MAX})} &= (V_{IN} - V_{OUT})I_{OUT} + (V_{IN} \cdot I_{GND}) \\ P_{D(150\text{mA})} &= (5.0V - 2.5V)150\text{mA} + (5.0V \cdot 1.1\mu\text{A}) \\ P_{D(150\text{mA})} &= 375\text{mW} \end{aligned}$$

$$\begin{aligned} P_{D(8.2\%D/C)} &= \%DC \cdot P_{D(150\text{mA})} \\ P_{D(8.2\%D/C)} &= 0.082 \cdot 375\text{mW} \\ P_{D(8.2\%D/C)} &= 30.75\text{mW} \end{aligned}$$

AAT3221/3222

150mA Nanopower™ LDO Linear Regulator

The power dissipation for a 150mA load occurring for 8.2% of the duty cycle will be 30.75mW. Finally, the two power dissipation levels can be summed to determine the total true power dissipation under the varied load:

$$P_{D(\text{total})} = P_{D(100\text{mA})} + P_{D(150\text{mA})}$$

$$P_{D(\text{total})} = 229.5\text{mW} + 30.75\text{mW}$$

$$P_{D(\text{total})} = 260.25\text{mW}$$

The maximum power dissipation for the AAT3221/2 operating at an ambient temperature of 85°C is 267mW. The device in this example will have a total power dissipation of 260.25mW. This is within the thermal limits for safe operation of the device.

Printed Circuit Board Layout Recommendations

In order to obtain the maximum performance from the AAT3221/2 LDO regulator, very careful attention must be considered in regard to the printed circuit board layout. If grounding connections are not properly made, power supply ripple rejection and LDO regulator transient response can be compromised.

The LDO regulator external capacitors C_{IN} and C_{OUT} should be connected as directly as possible to the ground pin of the LDO regulator. For maximum performance with the AAT3221/2, the ground pin connection should then be made directly back to the ground or common of the source power supply. If a direct ground return path is not possible due to printed circuit board layout limitations, the LDO ground pin should then be connected to the common ground plane in the application layout.

AAT3221/3222

150mA Nanopower™ LDO Linear Regulator

Ordering Information

Output Voltage	Enable	Package	Marking ¹	Part Number (Tape and Reel) ²		
1.6V	Active high	SOT23-5	GYXX	AAT3221IGV-1.6-T1		
1.7V			GBXX	AAT3221IGV-1.7-T1		
1.8V			BBXX	AAT3221IGV-1.8-T1		
1.9V			CGXX	AAT3221IGV-1.9-T1		
2.0V			BLXX	AAT3221IGV-2.0-T1		
2.3V			FLXX	AAT3221IGV-2.3-T1		
2.4V			FMXX	AAT3221IGV-2.4-T1		
2.5V			AKXX	AAT3221IGV-2.5-T1		
2.6V			GPXX	AAT3221IGV-2.6-T1		
2.7V			GDXX	AAT3221IGV-2.7-T1		
2.8V			AQXX	AAT3221IGV-2.8-T1		
2.85V			BYXX	AAT3221IGV-2.85-T1		
2.9V			JCXX	AAT3221IGV-2.9-T1		
3.0V			ALXX	AAT3221IGV-3.0-T1		
3.1V			GVXX	AAT3221IGV-3.1-T1		
3.3V			AMXX	AAT3221IGV-3.3-T1		
1.5V			Active high	SC70JW-8	CFXX	AAT3221IJS-1.5-T1
1.6V						AAT3221IJS-1.6-T1
1.7V						AAT3221IJS-1.7-T1
1.8V					BBXX	AAT3221IJS-1.8-T1
1.9V	CGXX	AAT3221IJS-1.9-T1				
2.0V	BLXX	AAT3221IJS-2.0-T1				
2.3V	FLXX	AAT3221IJS-2.3-T1				
2.4V	FMXX	AAT3221IJS-2.4-T1				
2.5V	AKXX	AAT3221IJS-2.5-T1				
2.6V	GPXX	AAT3221IJS-2.6-T1				
2.7V	GDXX	AAT3221IJS-2.7-T1				
2.8V	AQXX	AAT3221IJS-2.8-T1				
2.85V	BYXX	AAT3221IJS-2.85-T1				
2.9V	JCXX	AAT3221IJS-2.9-T1				
3.0V	ALXX	AAT3221IJS-3.0-T1				
3.1V	GVXX	AAT3221IJS-3.1-T1				
3.2V	LEXX	AAT3221IJS-3.2-T1				
3.3V	AMXX	AAT3221IJS-3.3-T1				
3.5V	BMXX	AAT3221IJS-3.5-T1				
2.8V	Active low	SOT23-5			BIXX	AAT3222IGV-2.8-T1
2.9V				AAT3222IGV-2.9-T1		
2.8V			CXXX	AAT3221IGV-2.8-2 T1		

1. XX = assembly and date code.

2. Sample stock is generally held on part numbers listed in **BOLD**.

Skyworks Green™ products are compliant with all applicable legislation and are halogen-free.

For additional information, refer to *Skyworks Definition of Green™*, document number SQ04-0074.

AAT3221/3222

150mA Nanopower™ LDO Linear Regulator

Package Information

SOT23-5

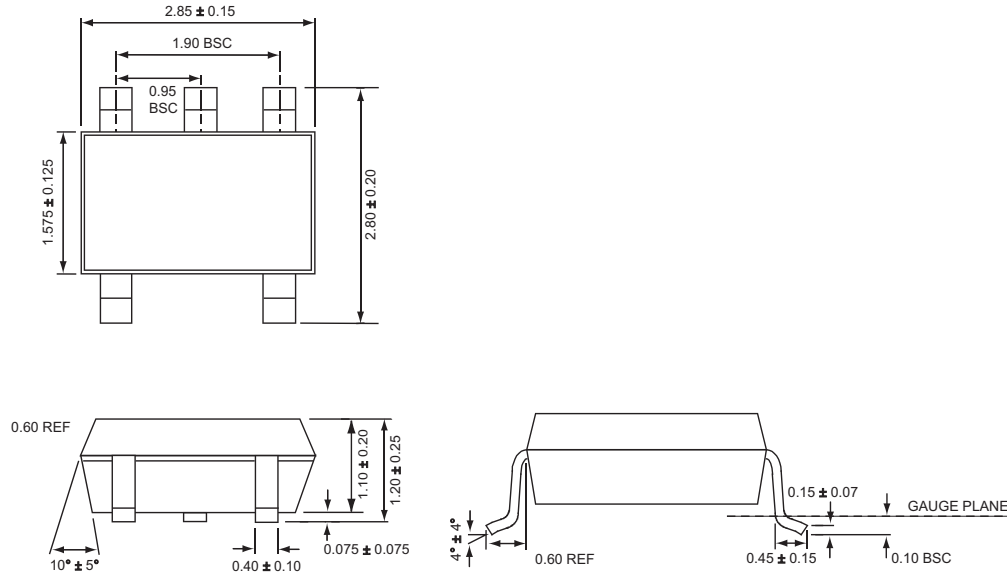

All measurements in millimeters.

SC70JW-8

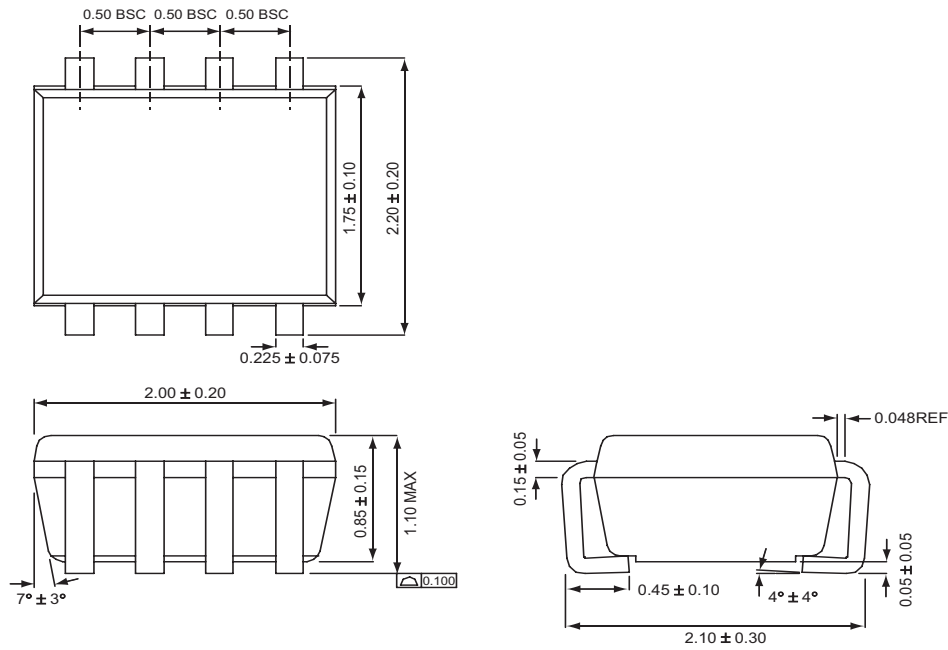

All measurements in millimeters.

AAT3221/3222

150mA Nanopower™ LDO Linear Regulator

Copyright © 2012 Skyworks Solutions, Inc. All Rights Reserved.

Information in this document is provided in connection with Skyworks Solutions, Inc. ("Skyworks") products or services. These materials, including the information contained herein, are provided by Skyworks as a service to its customers and may be used for informational purposes only by the customer. Skyworks assumes no responsibility for errors or omissions in these materials or the information contained herein. Skyworks may change its documentation, products, services, specifications or product descriptions at any time, without notice. Skyworks makes no commitment to update the materials or information and shall have no responsibility whatsoever for conflicts, incompatibilities, or other difficulties arising from any future changes.

No license, whether express, implied, by estoppel or otherwise, is granted to any intellectual property rights by this document. Skyworks assumes no liability for any materials, products or information provided hereunder, including the sale, distribution, reproduction or use of Skyworks products, information or materials, except as may be provided in Skyworks Terms and Conditions of Sale.

THE MATERIALS, PRODUCTS AND INFORMATION ARE PROVIDED "AS IS" WITHOUT WARRANTY OF ANY KIND, WHETHER EXPRESS, IMPLIED, STATUTORY, OR OTHERWISE, INCLUDING FITNESS FOR A PARTICULAR PURPOSE OR USE, MERCHANTABILITY, PERFORMANCE, QUALITY OR NON-INFRINGEMENT OF ANY INTELLECTUAL PROPERTY RIGHT; ALL SUCH WARRANTIES ARE HEREBY EXPRESSLY DISCLAIMED. SKYWORKS DOES NOT WARRANT THE ACCURACY OR COMPLETENESS OF THE INFORMATION, TEXT, GRAPHICS OR OTHER ITEMS CONTAINED WITHIN THESE MATERIALS. SKYWORKS SHALL NOT BE LIABLE FOR ANY DAMAGES, INCLUDING BUT NOT LIMITED TO ANY SPECIAL, INDIRECT, INCIDENTAL, STATUTORY, OR CONSEQUENTIAL DAMAGES, INCLUDING WITHOUT LIMITATION, LOST REVENUES OR LOST PROFITS THAT MAY RESULT FROM THE USE OF THE MATERIALS OR INFORMATION, WHETHER OR NOT THE RECIPIENT OF MATERIALS HAS BEEN ADVISED OF THE POSSIBILITY OF SUCH DAMAGE.

Skyworks products are not intended for use in medical, lifesaving or life-sustaining applications, or other equipment in which the failure of the Skyworks products could lead to personal injury, death, physical or environmental damage. Skyworks customers using or selling Skyworks products for use in such applications do so at their own risk and agree to fully indemnify Skyworks for any damages resulting from such improper use or sale.

Customers are responsible for their products and applications using Skyworks products, which may deviate from published specifications as a result of design defects, errors, or operation of products outside of published parameters or design specifications. Customers should include design and operating safeguards to minimize these and other risks. Skyworks assumes no liability for applications assistance, customer product design, or damage to any equipment resulting from the use of Skyworks products outside of stated published specifications or parameters.

Skyworks, the Skyworks symbol, and "Breakthrough Simplicity" are trademarks or registered trademarks of Skyworks Solutions, Inc., in the United States and other countries. Third-party brands and names are for identification purposes only, and are the property of their respective owners. Additional information, including relevant terms and conditions, posted at www.skyworksinc.com, are incorporated by reference.