

General Description

The AAT4610A SmartSwitch is a current limited P-channel MOSFET power switch designed for high-side load switching applications. This switch operates with inputs ranging from 2.4V to 5.5V, making it ideal for both 3V and 5V systems. An integrated current-limiting circuit protects the input supply against large currents which may cause the supply to fall out of regulation. The AAT4610A is also protected from thermal overload which limits power dissipation and junction temperatures. It can be used to control loads that require up to 1A. Current limit threshold is programmed with a resistor from SET to ground. The quiescent supply current is typically a low 9 μ A. In shutdown mode, the supply current decreases to less than 1 μ A.

The AAT4610A is available in a Pb-free 5-pin SOT23 or 8-pin SC70JW package and is specified over the -40°C to +85°C temperature range.

Features

- Input Voltage Range: 2.4V to 5.5V
- Programmable Over-Current Threshold
- Fast Transient Response:
 - 400ns Response to Short Circuit
- Low Quiescent Current
 - 9 μ A Typical
 - 1 μ A Max with Switch Off
- 145m Ω Typical $R_{DS(ON)}$
- Only 2.5V Needed for ON/OFF Control
- Under-Voltage Lockout
- Thermal Shutdown
- 4kV ESD Rating
- UL Approved—File No. E217765
- 5-Pin SOT23 or 8-Pin SC70JW Package
- Temperature Range: -40°C to +85°C

Applications

- Hot Swap Supplies
- Notebook Computers
- Peripheral Ports
- Personal Communication Devices



UL Recognized Component

Typical Application

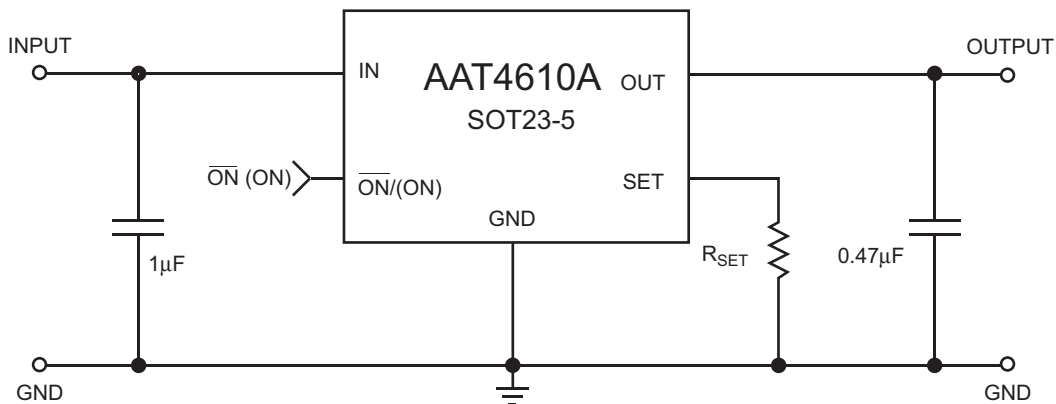

AAT4610A**Current Limited Load Switch****Pin Descriptions**

Pin Number		Symbol	Function
SOT23-5	SC70JW-8		
1	5	OUT	P-channel MOSFET drain. Connect a 0.47 μ F capacitor from OUT to GND.
2	6, 7, 8	GND	Ground connection.
3	1	SET	Current limit set input. A resistor from SET to ground sets the current limit for the switch.
4	2	$\overline{\text{ON}}$	Enable input. Two versions are available, active-high and active-low. See Ordering Information for details.
5	3, 4	IN	P-channel MOSFET source. Connect a 1 μ F capacitor from IN to GND.

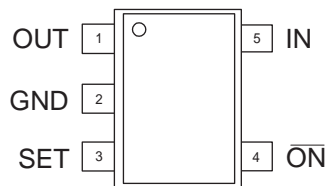
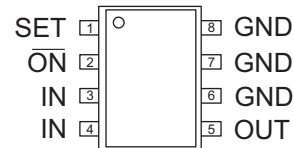
Pin Configuration**SOT23-5
(Top View)****SC70JW-8
(Top View)**

DATA SHEET

AAT4610A

Current Limited Load Switch

Absolute Maximum Ratings¹

$T_A = 25^\circ\text{C}$, unless otherwise noted.

Symbol	Description	Value	Units
V_{IN}	IN to GND	-0.3 to 6	V
V_{ON}	\overline{ON} (ON) to GND	-0.3 to $V_{IN} + 0.3$	V
V_{SET}, V_{OUT}	SET, OUT to GND	-0.3 to $V_{IN} + 0.3$	V
I_{MAX}	Maximum Continuous Switch Current	2	A
T_J	Operating Junction Temperature Range	-40 to 150	$^\circ\text{C}$
T_{LEAD}	Maximum Soldering Temperature (at Leads)	300	$^\circ\text{C}$
V_{ESD}	ESD Rating ² - HBM	4000	V

Thermal Characteristics³

Symbol	Description	Value	Units
Θ_{JA}	Thermal Resistance (SOT23-5 or SC70JW-8)	150	$^\circ\text{C}/\text{W}$
P_D	Power Dissipation (SOT23-5 or SC70JW-8)	667	mW

1. Stresses above those listed in Absolute Maximum Ratings may cause permanent damage to the device. Functional operation at conditions other than the operating conditions specified is not implied. Only one Absolute Maximum Rating should be applied at any one time.
2. Human body model is a 100pF capacitor discharged through a 1.5k Ω resistor into each pin.
3. Mounted on a demo board.

DATA SHEET

AAT4610A

Current Limited Load Switch

Electrical Characteristics

$V_{IN} = 5V$, $T_A = -40^{\circ}C$ to $+85^{\circ}C$, unless otherwise noted. Typical values are $T_A = 25^{\circ}C$.

Symbol	Description	Conditions	Min	Typ	Max	Units
V_{IN}	Operation Voltage		2.4		5.5	V
I_Q	Quiescent Current	$V_{IN} = 5V$, ON (\overline{ON}) = Active, $I_{OUT} = 0$		9	25	μA
$I_{Q(OFF)}$	Off Supply Current	ON (\overline{ON}) = Inactive, $V_{IN} = 5.5V$			1	μA
$I_{SD(OFF)}$	Off Switch Current	ON (\overline{ON}) = Inactive, $V_{IN} = 5.5V$, $V_{OUT} = 0$		0.01	1	μA
V_{UVLO}	Under-Voltage Lockout	Rising Edge, 1% Hysteresis		1.8	2.4	V
$R_{DS(ON)}$	On Resistance	$V_{IN} = 5.0V$, $T_A = 25^{\circ}C$		145	180	m Ω
		$V_{IN} = 4.5V$, $T_A = 25^{\circ}C$		150		
		$V_{IN} = 3.0V$, $T_A = 25^{\circ}C$		190	230	
TC_{RDS}	On Resistance Temperature Coefficient			2800		ppm/ $^{\circ}C$
I_{LIM}	Current Limit	$R_{SET} = 6.8k\Omega$	0.75	1	1.25	A
$I_{LIM(MIN)}$	Minimum Current Limit			130		mA
$V_{ON(L)}$	ON (\overline{ON}) Input Low Voltage	$V_{IN} = 2.7V$ to $5.5V^1$			0.8	V
$V_{ON(H)}$	ON (\overline{ON}) Input High Voltage	$V_{IN} = 2.7V$ to $< 4.2V^1$	2.0			V
		$V_{IN} \geq 4.2V$ to $5.0V^1$	2.4			
$I_{ON(SINK)}$	ON (\overline{ON}) Input Leakage	$V_{ON} = 5.5V$		0.01	1	μA
T_{RESP}	Current Limit Response Time	$V_{IN} = 5V$		0.4		μs
T_{OFF}	Turn-Off Time	$V_{IN} = 5V$, $R_L = 10\Omega$		4	12	μs
T_{ON}	Turn-On Time	$V_{IN} = 5V$, $R_L = 10\Omega$		12	200	μs
T_{SD}	Over-Temperature Threshold	$V_{IN} = 5V$	T_J Increasing		125	$^{\circ}C$
			T_J Decreasing		115	

1. For V_{IN} outside this range, consult Typical ON (\overline{ON}) Threshold curve.

DATA SHEET

AAT4610A

Current Limited Load Switch

Typical Characteristics

Unless otherwise noted, $V_{IN} = 5V$, $T_A = 25^\circ C$.

Quiescent Current vs. Temperature

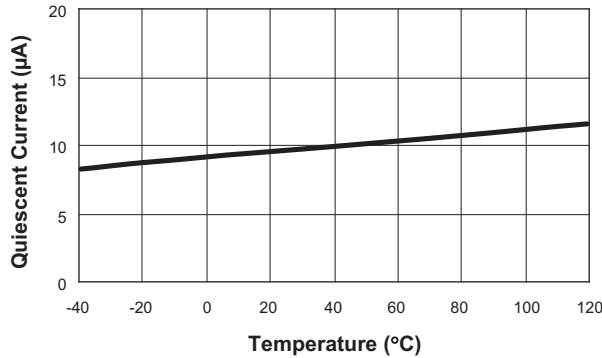

Quiescent Current vs. Input Voltage

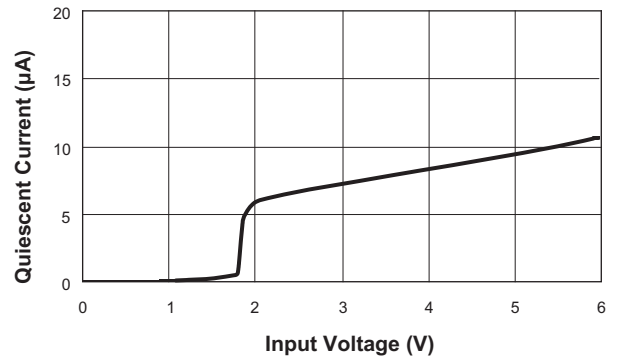

Output Current vs. Output Voltage
($R_{SET} = 16k\Omega$)

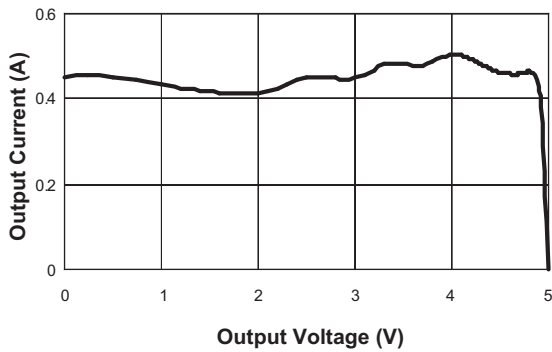

$R_{DS(ON)}$ vs. Temperature

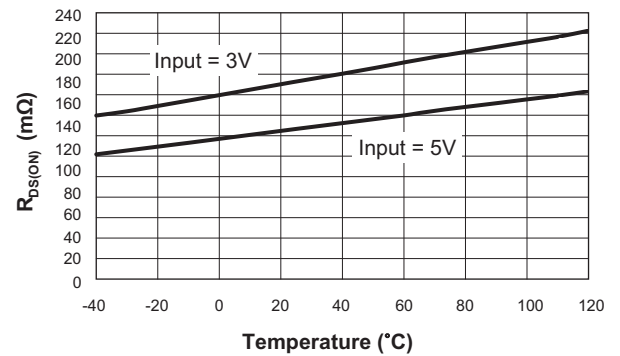

Off-Supply Current vs. Temperature

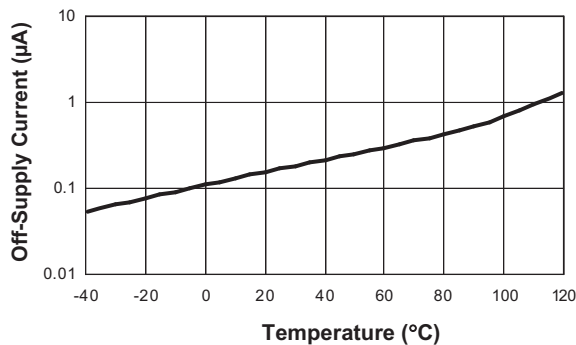

Off-Switch Current vs. Temperature

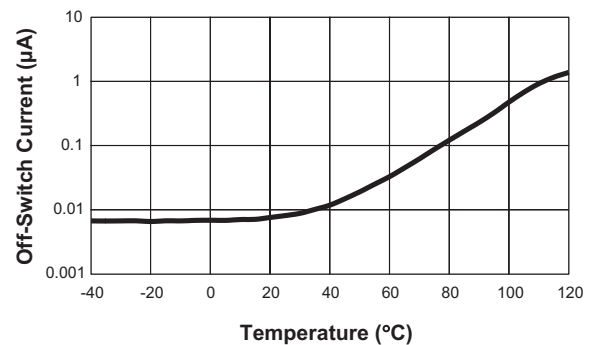

AAT4610A

Current Limited Load Switch

Typical Characteristics

Unless otherwise noted, $V_{IN} = 5V$, $T_A = 25^\circ C$.

Turn-On vs. Temperature
($R_{LOAD} = 10\Omega$; $C_{LOAD} = 0.47\mu F$)

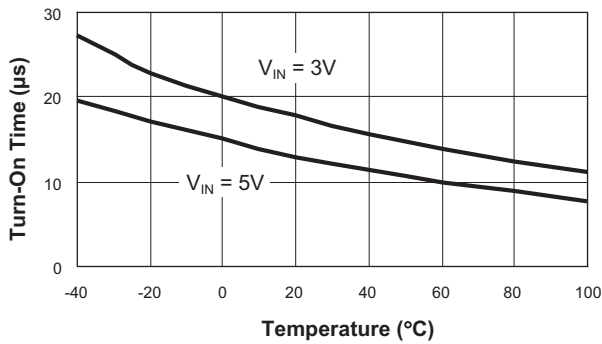

Turn-Off vs. Temperature
($R_{LOAD} = 10\Omega$; $C_{LOAD} = 0.47\mu F$)

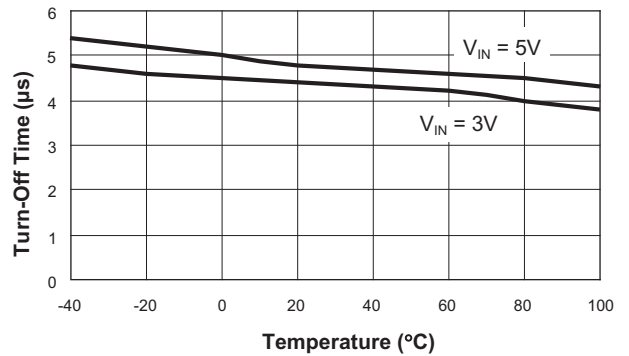

Turn-On
($R_L = 10\Omega$; $C_L = 0.47\mu F$)

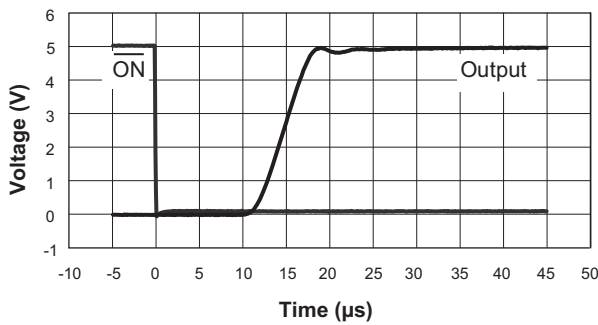

Turn-Off
($R_L = 10\Omega$; $C_L = 0.47\mu F$)

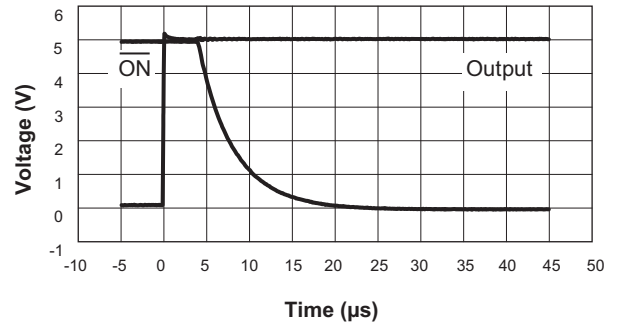

Short-Circuit Through 0.3 Ω

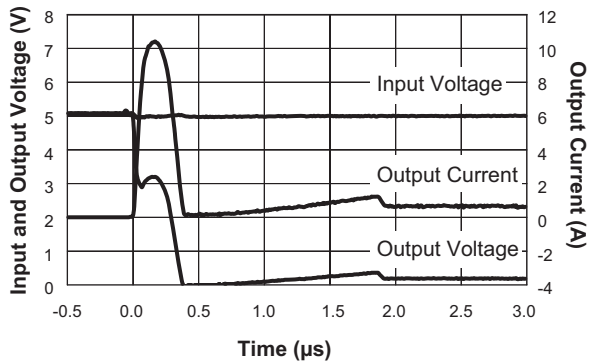

V_{IH} and V_{IL} vs. V_{IN}

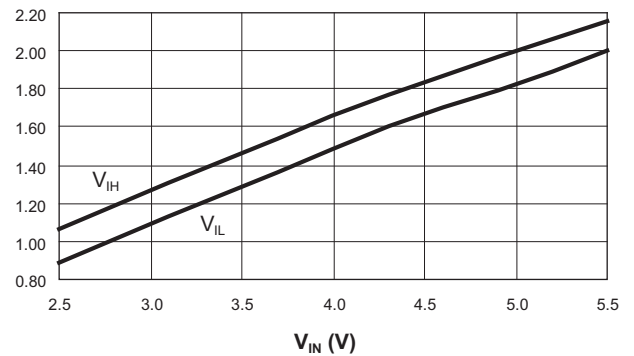

AAT4610A

Current Limited Load Switch

Typical Characteristics

Unless otherwise noted, $V_{IN} = 5V$, $T_A = 25^\circ C$.

R_{SET} vs. I_{LIM}

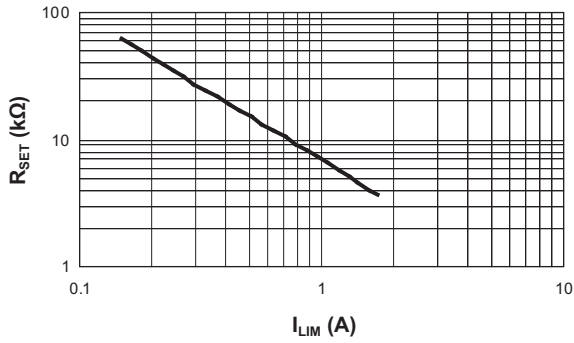

R_{SET} Coefficient vs. I_{LIM}

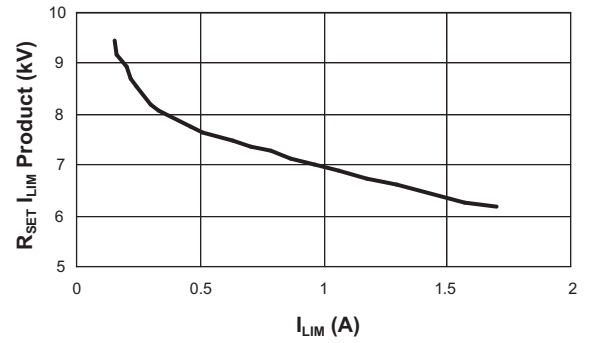

Current Limit vs. Temperature

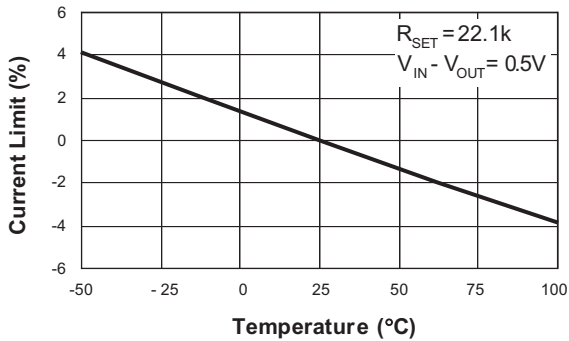

Functional Block Diagram

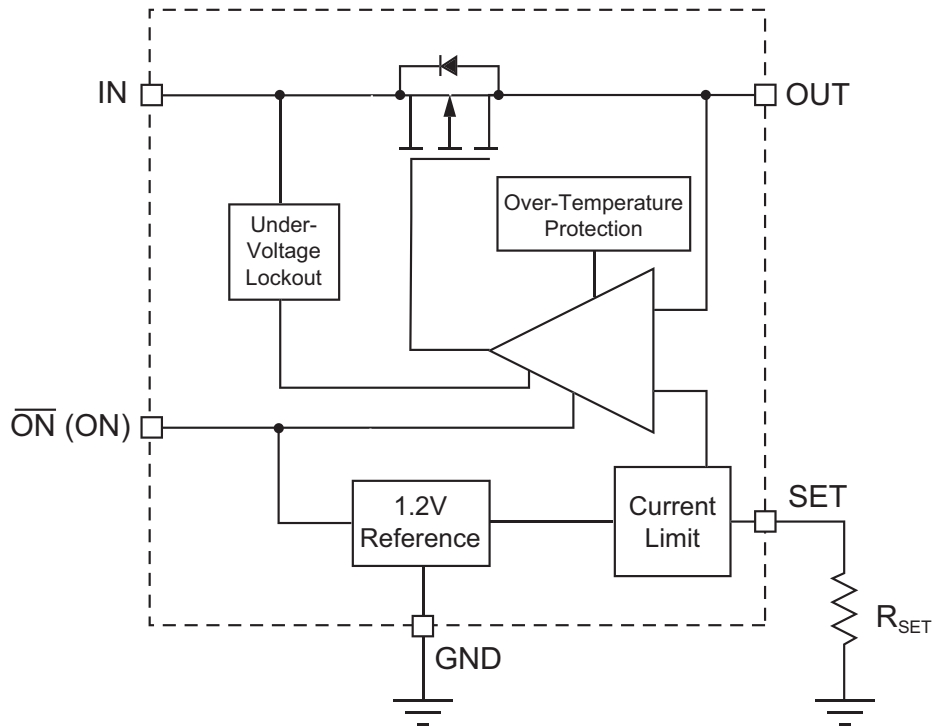

Application Information

Setting Current Limit

In most applications, the variation in I_{LIM} must be taken into account when determining R_{SET} . The I_{LIM} variation is due to processing variations from part to part, as well as variations in the voltages at IN and OUT, plus the operating temperature. See charts "Current Limit vs. Temperature" and "Output Current vs. V_{OUT} ." Together, these three factors add up to a $\pm 25\%$ tolerance (see I_{LIM} specification in Electrical Characteristics section). Figure 1 illustrates a cold device with a statistically higher current limit and a hot device with a statistically lower current limit, both with R_{SET} equal to $10.5k\Omega$. While the chart, " R_{SET} vs. I_{LIM} " indicates an I_{LIM} of $0.7A$ with an R_{SET} of $10.5k\Omega$, this figure shows that the actual current limit will be at least $0.525A$ and no greater than $0.880A$.

To determine R_{SET} , start with the maximum current drawn by the load and multiply it by 1.33 (typical $I_{LIM} = \text{minimum } I_{LIM} / 0.75$). This is the typical current limit value. Next, refer to " R_{SET} vs. I_{LIM} " and find the R_{SET} that corresponds to the typical current limit value. Choose the

largest resistor available that is less than or equal to it. For greater precision, the value of R_{SET} may also be calculated using the $I_{LIM} R_{SET}$ product found in the chart " R_{SET} Coefficient vs. I_{LIM} ." The maximum current is derived by multiplying the typical current for the chosen R_{SET} in the chart by 1.25. A few standard resistor values are listed in Table 1.

Current Limit Using $10.5k\Omega$

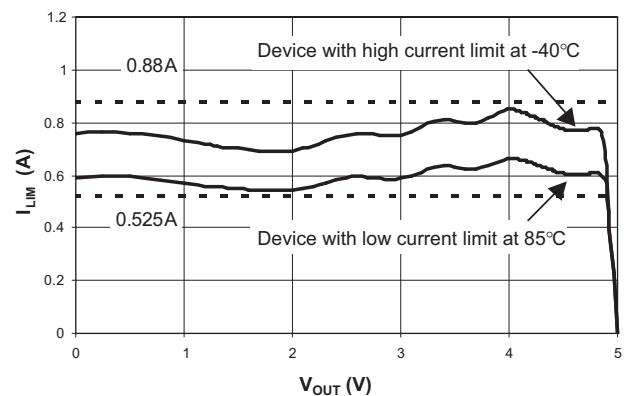

Figure 1: Current Limit Using $10.5k\Omega$.

AAT4610A

Current Limited Load Switch

R_{SET} (k Ω)	Current Limit Typ (mA)	Device Will Not Current Limit Below (mA)	Device Always Current Limits Below (mA)
40.2	200	150	250
30.9	250	188	313
24.9	300	225	375
22.1	350	263	438
19.6	400	300	500
17.8	450	338	563
16.2	500	375	625
14.7	550	413	688
13.0	600	450	750
10.5	700	525	875
8.87	800	600	1000
7.50	900	675	1125
6.81	1000	750	1250
6.04	1100	825	1375
5.49	1200	900	1500
4.99	1300	975	1625
4.64	1400	1050	1750

Table 1: Current Limit R_{SET} Values

Example: A USB port requires 0.5A. 0.5A multiplied by 1.33 is 0.665A. From the chart named " R_{SET} vs. I_{LIM} ," R_{SET} should be less than 11k Ω . 10.5k Ω is a standard value that is a little less than 11k Ω but very close. The chart reads approximately 0.700A as a typical I_{LIM} value for 10.5k Ω . Multiplying 0.700A by 0.75 and 1.25 shows that the AAT4610A will limit the load current to greater than 0.525A but less than 0.875A.

Operation in Current Limit

When a heavy load is applied to the output of the AAT4610A, the load current is limited to the value of I_{LIM} determined by R_{SET} (see Figure 2). Since the load is demanding more current than I_{LIM} , the voltage at the output drops. This causes the AAT4610A to dissipate a larger than normal quantity of power, and its die temperature to increase. When the die temperature exceeds an over-temperature limit, the AAT4610A will shut down until it has cooled sufficiently, at which point it will startup again. The AAT4610A will continue to cycle on and off until the load is removed, power is removed, or until a logic high level is applied to ON.

Enable Input

In many systems, power planes are controlled by integrated circuits which run at lower voltages than the power plane itself. The enable input ON of the AAT4610A has low and high threshold voltages that accommodate this condition. The threshold voltages are compatible with 5V TTL and 2.5V to 5V CMOS.

Reverse Voltage

The AAT4610A is designed to control current flowing from IN to OUT. If a voltage is applied to OUT which is greater than the voltage on IN, large currents may flow. This could cause damage to the AAT4610A.

Overload Operation

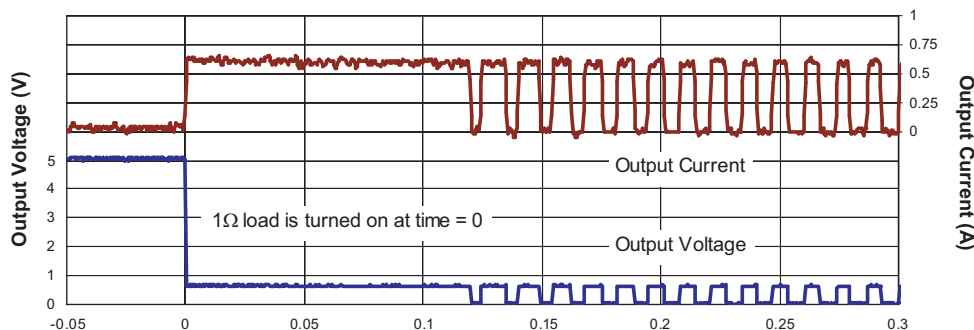
**Figure 2: Overload Operation.**

AAT4610A

Current Limited Load Switch

Ordering Information

Package	Enable	Marking ¹	Part Number (Tape and Reel) ²
SOT23-5	ON (active low)	ERXY	AAT4610AIGV-T1
SOT23-5	ON (active high)	HXXYY	AAT4610AIGV-1-T1
SC70JW-8	ON (active low)	FKXY	AAT4610AIJS-T1
SC70JW-8	ON (active high)	HXXYY	AAT4610AIJS-1-T1



Skyworks Green™ products are compliant with all applicable legislation and are halogen-free. For additional information, refer to *Skyworks Definition of Green™*, document number SQ04-0074.

Package Information

SOT23-5

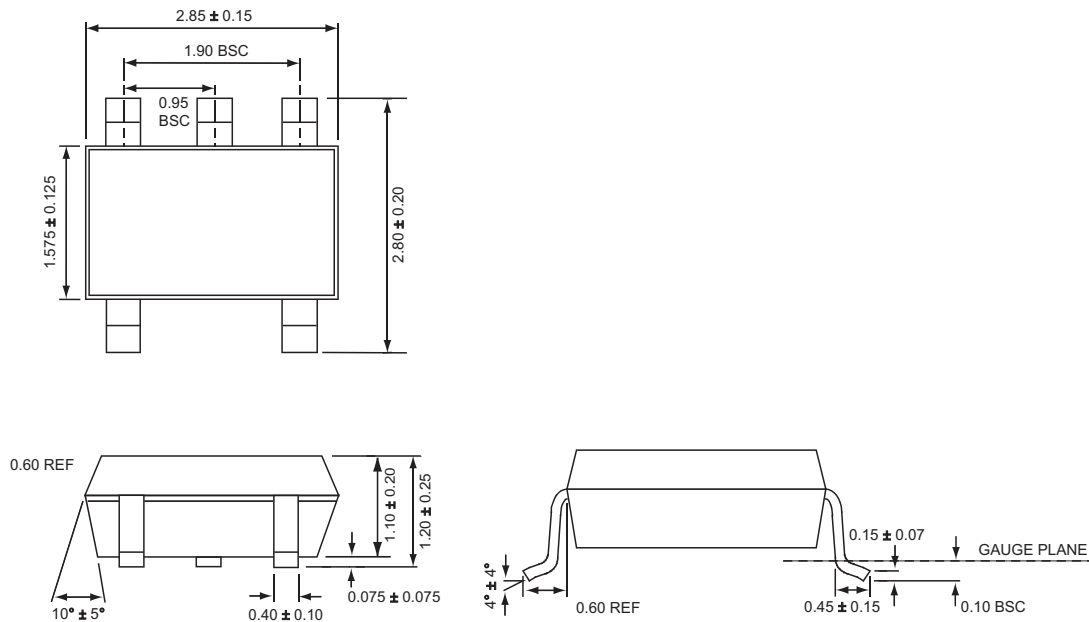

All dimensions in millimeters.

1. XYY = assembly and date code.
 2. Sample stock is generally held on part numbers listed in **BOLD**.

AAT4610A

Current Limited Load Switch

SC70JW-8

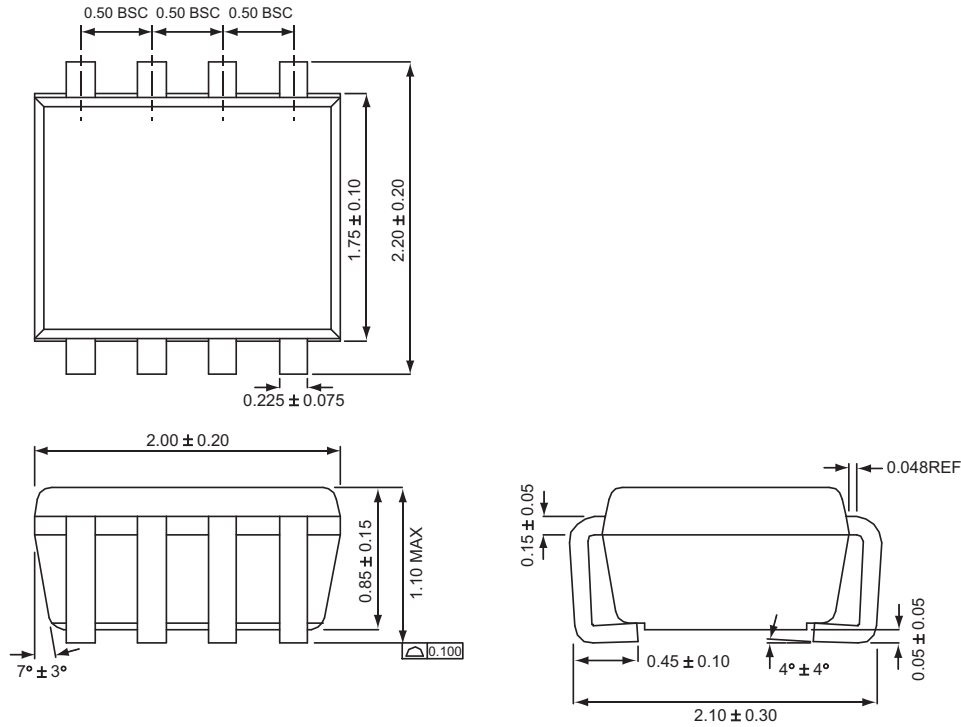

All dimensions in millimeters.

Copyright © 2012 Skyworks Solutions, Inc. All Rights Reserved.

Information in this document is provided in connection with Skyworks Solutions, Inc. ("Skyworks") products or services. These materials, including the information contained herein, are provided by Skyworks as a service to its customers and may be used for informational purposes only by the customer. Skyworks assumes no responsibility for errors or omissions in these materials or the information contained herein. Skyworks may change its documentation, products, services, specifications or product descriptions at any time, without notice. Skyworks makes no commitment to update the materials or information and shall have no responsibility whatsoever for conflicts, incompatibilities, or other difficulties arising from any future changes.

No license, whether express, implied, by estoppel or otherwise, is granted to any intellectual property rights by this document. Skyworks assumes no liability for any materials, products or information provided hereunder, including the sale, distribution, reproduction or use of Skyworks products, information or materials, except as may be provided in Skyworks Terms and Conditions of Sale.

THE MATERIALS, PRODUCTS AND INFORMATION ARE PROVIDED "AS IS" WITHOUT WARRANTY OF ANY KIND, WHETHER EXPRESS, IMPLIED, STATUTORY, OR OTHERWISE, INCLUDING FITNESS FOR A PARTICULAR PURPOSE OR USE, MERCHANTABILITY, PERFORMANCE, QUALITY OR NON-INFRINGEMENT OF ANY INTELLECTUAL PROPERTY RIGHT; ALL SUCH WARRANTIES ARE HEREBY EXPRESSLY DISCLAIMED. SKYWORKS DOES NOT WARRANT THE ACCURACY OR COMPLETENESS OF THE INFORMATION, TEXT, GRAPHICS OR OTHER ITEMS CONTAINED WITHIN THESE MATERIALS. SKYWORKS SHALL NOT BE LIABLE FOR ANY DAMAGES, INCLUDING BUT NOT LIMITED TO ANY SPECIAL, INDIRECT, INCIDENTAL, STATUTORY, OR CONSEQUENTIAL DAMAGES, INCLUDING WITHOUT LIMITATION, LOST REVENUES OR LOST PROFITS THAT MAY RESULT FROM THE USE OF THE MATERIALS OR INFORMATION, WHETHER OR NOT THE RECIPIENT OF MATERIALS HAS BEEN ADVISED OF THE POSSIBILITY OF SUCH DAMAGE.

Skyworks products are not intended for use in medical, lifesaving or life-sustaining applications, or other equipment in which the failure of the Skyworks products could lead to personal injury, death, physical or environmental damage. Skyworks customers using or selling Skyworks products for use in such applications do so at their own risk and agree to fully indemnify Skyworks for any damages resulting from such improper use or sale.

Customers are responsible for their products and applications using Skyworks products, which may deviate from published specifications as a result of design defects, errors, or operation of products outside of published parameters or design specifications. Customers should include design and operating safeguards to minimize these and other risks. Skyworks assumes no liability for applications assistance, customer product design, or damage to any equipment resulting from the use of Skyworks products outside of stated published specifications or parameters.

Skyworks, the Skyworks symbol, and "Breakthrough Simplicity" are trademarks or registered trademarks of Skyworks Solutions, Inc., in the United States and other countries. Third-party brands and names are for identification purposes only, and are the property of their respective owners. Additional information, including relevant terms and conditions, posted at www.skyworksinc.com, are incorporated by reference.