

PRELIMINARY DATA SHEET

MAFR-000493-000001: 1030-1090 MHz Single Junction Drop-In Circulator

Applications

- Radar systems
- Power amplifiers

Features

- BeO free
- Operating frequency range: 1030 MHz to 1090 MHz



Skyworks Green™ products are compliant with all applicable legislation and are halogen-free. For additional information, refer to *Skyworks Definition of Green™*, document number SQ04-0074.

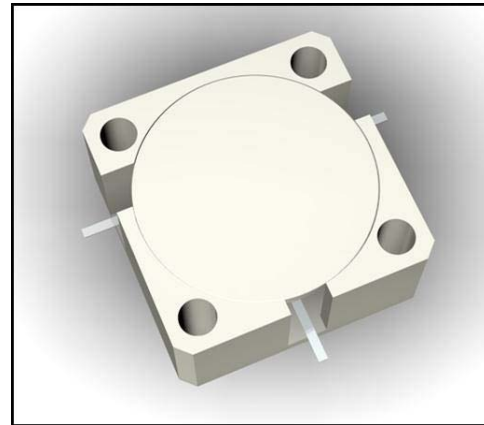

Description

The MAFR-000493-000001 is a single-junction circulator designed for radar and Power Amplifier (PA) applications. It operates over the frequency range of 1030 MHz to 1090 MHz. Insertion loss is less than 0.30 dB over an operating temperature range of $-40\text{ }^{\circ}\text{C}$ to $+85\text{ }^{\circ}\text{C}$.

The MAFR-000493-000001 comes in an industry-recognized package designed for drop-in assembly.

A block diagram of the MAFR-000493-000001 is shown in Figure 1. The absolute maximum ratings of the MAFR-000493-000001 are provided in Table 1.

Electrical specifications are provided in Table 2. Plating information is shown in Table 3.

Figure 2 shows the package dimensions.

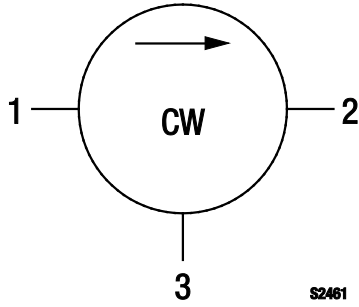

Figure 1. MAFR-000493-000001 Block Diagram

Table 1. MAFR-000493-000001 Absolute Maximum Ratings

Parameter	Symbol	Minimum	Maximum	Units
Average power	P _{AVG}		200	W
Peak power	P _{PEAK}		1200	W
Operating temperature	T _{OP}	-40	+85	°C
Storage temperature	T _{ST}	-55	+125	°C

Note: Exposure to maximum rating conditions for extended periods may reduce device reliability. There is no damage to device with only one parameter set at the limit and all other parameters set at or below their nominal value. Exceeding any of the limits listed here may result in permanent damage to the device.

Table 2. MAFR-000493-000001 Electrical Specifications (Note 1)

(T_{OP} = -40 °C to +85 °C)

Parameter	Symbol	Test Condition	Min	Typical	Max	Units
Frequency range	f		1030		1090	MHz
Impedance				50		Ω
Insertion loss	IL				0.30	dB
Isolation	ISO		18			dB
Return loss	RL		18			dB

Note 1: Performance is guaranteed only under the conditions listed in this Table.

Note 2: See Skyworks Application Note, *Intermodulation Distortion Measurements of Ferrites*, document number 201537 for further details.

Table 3. MAFR-000493-000001 Plating

Section	Material	Plating
Leads	Copper	Silver
Housing	Steel	Nickel

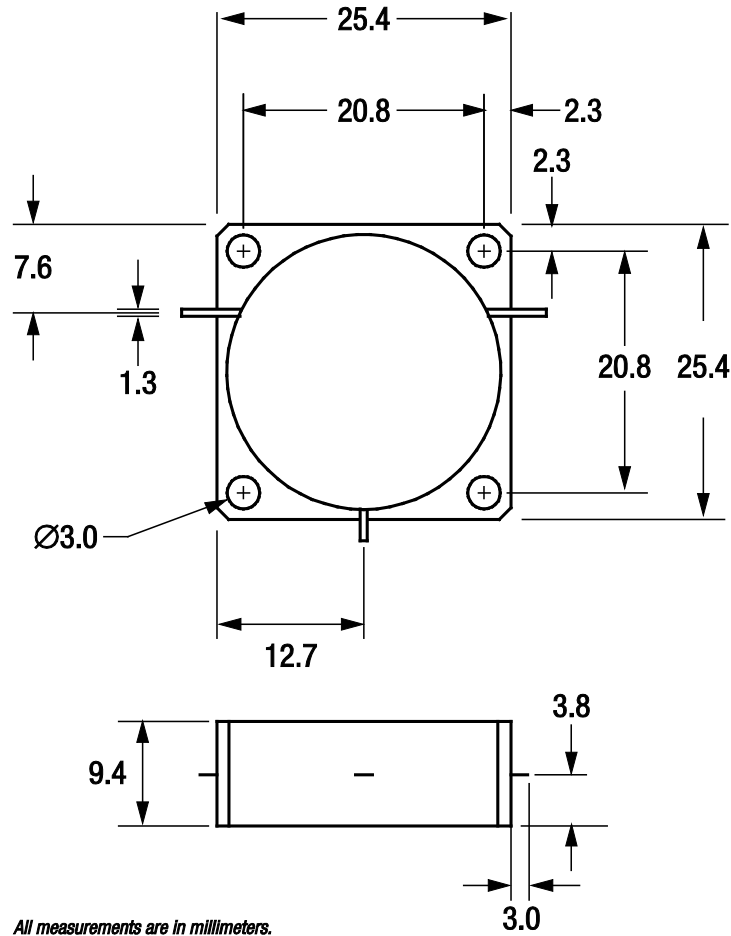

All measurements are in millimeters.

Tolerance: ± 0.2 mm unless otherwise noted.

Lead thickness is 0.12 mm.

Model number, lot code, and port designation printed on top side of device.

S2599a

Figure 2. MAFR-000493-000001 Package Dimensions

Ordering Information

Model Name	Manufacturing Part Number	Evaluation Board Part Number
MAFR-000493-000001 Single Junction Drop-In Circulator	MAFR-000493-000001	MAFX-999999-000PPR

Copyright © 2011 Skyworks Solutions, Inc. All Rights Reserved.

Information in this document is provided in connection with Skyworks Solutions, Inc. ("Skyworks") products or services. These materials, including the information contained herein, are provided by Skyworks as a service to its customers and may be used for informational purposes only by the customer. Skyworks assumes no responsibility for errors or omissions in these materials or the information contained herein. Skyworks may change its documentation, products, services, specifications or product descriptions at any time, without notice. Skyworks makes no commitment to update the materials or information and shall have no responsibility whatsoever for conflicts, incompatibilities, or other difficulties arising from any future changes.

No license, whether express, implied, by estoppel or otherwise, is granted to any intellectual property rights by this document. Skyworks assumes no liability for any materials, products or information provided hereunder, including the sale, distribution, reproduction or use of Skyworks products, information or materials, except as may be provided in Skyworks Terms and Conditions of Sale.

THE MATERIALS, PRODUCTS AND INFORMATION ARE PROVIDED "AS IS" WITHOUT WARRANTY OF ANY KIND, WHETHER EXPRESS, IMPLIED, STATUTORY, OR OTHERWISE, INCLUDING FITNESS FOR A PARTICULAR PURPOSE OR USE, MERCHANTABILITY, PERFORMANCE, QUALITY OR NON-INFRINGEMENT OF ANY INTELLECTUAL PROPERTY RIGHT; ALL SUCH WARRANTIES ARE HEREBY EXPRESSLY DISCLAIMED. SKYWORKS DOES NOT WARRANT THE ACCURACY OR COMPLETENESS OF THE INFORMATION, TEXT, GRAPHICS OR OTHER ITEMS CONTAINED WITHIN THESE MATERIALS. SKYWORKS SHALL NOT BE LIABLE FOR ANY DAMAGES, INCLUDING BUT NOT LIMITED TO ANY SPECIAL, INDIRECT, INCIDENTAL, STATUTORY, OR CONSEQUENTIAL DAMAGES, INCLUDING WITHOUT LIMITATION, LOST REVENUES OR LOST PROFITS THAT MAY RESULT FROM THE USE OF THE MATERIALS OR INFORMATION, WHETHER OR NOT THE RECIPIENT OF MATERIALS HAS BEEN ADVISED OF THE POSSIBILITY OF SUCH DAMAGE.

Skyworks products are not intended for use in medical, lifesaving or life-sustaining applications, or other equipment in which the failure of the Skyworks products could lead to personal injury, death, physical or environmental damage. Skyworks customers using or selling Skyworks products for use in such applications do so at their own risk and agree to fully indemnify Skyworks for any damages resulting from such improper use or sale.

Customers are responsible for their products and applications using Skyworks products, which may deviate from published specifications as a result of design defects, errors, or operation of products outside of published parameters or design specifications. Customers should include design and operating safeguards to minimize these and other risks. Skyworks assumes no liability for applications assistance, customer product design, or damage to any equipment resulting from the use of Skyworks products outside of stated published specifications or parameters.

Skyworks, the Skyworks symbol, and "Breakthrough Simplicity" are trademarks or registered trademarks of Skyworks Solutions, Inc., in the United States and other countries. Third-party brands and names are for identification purposes only, and are the property of their respective owners. Additional information, including relevant terms and conditions, posted at www.skyworksinc.com, are incorporated by reference.