

DATA SHEET

SKY12329-350LF: GaAs Digital Attenuator

5-Bit, 1 dB LSB 400 MHz–4 GHz

Applications

- Transceiver transmit automatic level control or receive automatic gain control in WiMAX, GSM, CDMA, WCDMA, WLAN, Bluetooth®, Zigbee®, Land Mobile Radio Base stations or Terminal Equipment
- General purpose signal attenuation in telecommunications and instrumentation applications

Features

- Broadband: 400 MHz–4 GHz
- Attenuation range: 31 dB
- Least significant bit attenuation: 1 dB
- Low insertion loss: 1.2 dB @ 900 MHz
- Single positive control voltage: 2.7–5.5 V
- Low current consumption: <100 μ A @ 5 V
- Small QFN-16 3 x 3 mm package with exposed paddle
- Lead (Pb)-free and RoHS-compliant MSL-1 @ 260 °C per JEDEC J-STD-020

Description

The SKY12329-350LF is a monolithic GaAs, binary-weighted, 5-bit, single positive control voltage digital attenuator which operates from 400 MHz–4 GHz. The attenuator has a least significant bit (LSB) of 1 dB and total attenuation of 31 dB. The two RF ports are bilateral; each can be used as the RF input or the RF output. This attenuator requires an external supply voltage of 2.7–5.5 V.

The SKY12329-350LF is comprised of 5 fixed attenuators in cascade, each of which having a shunt bypass switch. Beginning at the LSB, which is 1 dB, each succeeding fixed attenuator produces twice the attenuation of the preceding stage. The state of each bypass switch is controlled by the logic level voltage applied to the associated control voltage input; a logic high voltage closes the associated switch, thereby

Functional Block Diagram

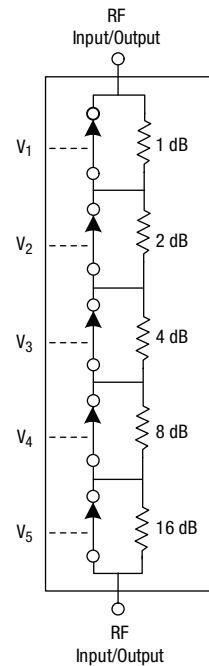

bypassing that fixed attenuator stage, and a logic low opens the switch to force the input signal to that stage through the associated attenuator.

DC power consumption is very low, 100 μ A maximum with control voltage and supply voltage of 5 V. The switch can operate over the temperature range of -40 °C to +85 °C.

An evaluation board is available upon request.

NEW Skyworks offers lead (Pb)-free, RoHS (Restriction of Hazardous Substances)-compliant packaging.



Electrical Specifications

V_{CTL} = 0 V/5 V, T = 25 °C, P_{INPUT} = 0 dBm, Z₀ = 50 Ω, unless otherwise noted

Parameter	Condition	Frequency	Min.	Typ.	Max.	Unit
Insertion loss		0.4–1.0 GHz		1.2	1.6	dB
		1.0–2.0 GHz		1.5	1.9	dB
		2.0–3.0 GHz		1.8	2.2	dB
		3.0–4.0 GHz		2.7	3.1	dB
Attenuation range				31		dB
Attenuation accuracy	Attenuation referred to insertion loss. All attenuation states	0.4–1.0 GHz	± (0.35 + 3% of attenuation setting in dB)			dB
	All attenuation states	1.0–3.0 GHz	± (0.3 + 3% of attenuation setting in dB)			dB
	1–15 dB attenuation states	3.0–4.0 GHz	± (0.5 + 5% of attenuation setting in dB)			dB
	16–31 dB attenuation states	3.0–4.0 GHz	± (0.6 + 6% of attenuation setting in dB)			dB
Return loss		0.4–1.0 GHz		7		dB
		1.0–4.0 GHz		10		dB

Operating Characteristics

V_{CTL} = 0 V/5 V, T = 25 °C, P_{INPUT} = 0 dBm, Z₀ = 50 Ω, unless otherwise noted

Parameter	Condition	Frequency	Min.	Typ.	Max.	Unit
Switching characteristics						
On/rise time	50/90% or 10/90% RF			150		ns
Off/fall time	50/10% or 90/10% RF			500		ns
Input power for 1 dB compression	V _{LOW} = 0 V, V _{HIGH} = 3 V V _{LOW} = 0 V, V _{HIGH} = 5 V	900 MHz		29		dBm
		900 MHz		31		dBm
Input third order intermodulation intercept	For two input tones. +5 dBm each tone V _{LOW} = 0 V, V _{HIGH} = 3 V V _{LOW} = 0 V, V _{HIGH} = 5 V	1–4 GHz		39		dBm
		1–4 GHz		41		dBm
Thermal resistance	Junction to package terminal			45		°C/W
Supply voltage			V _{HIGH} - 0.2		V _{HIGH} + 0.2	V
Control voltage	High		2.7		5.5	V
	Low		-0.2		0.2	V
Control port current	V _{CTL} = V _{HIGH}			15	100	μA
	V _{CTL} = V _{LOW}			5	20	μA

Typical Performance Data

$V_{CTL} = 0\text{ V/5 V}$, $T = 25\text{ }^\circ\text{C}$, $P_{INPUT} = 0\text{ dBm}$, $Z_0 = 50\text{ }\Omega$, unless otherwise noted

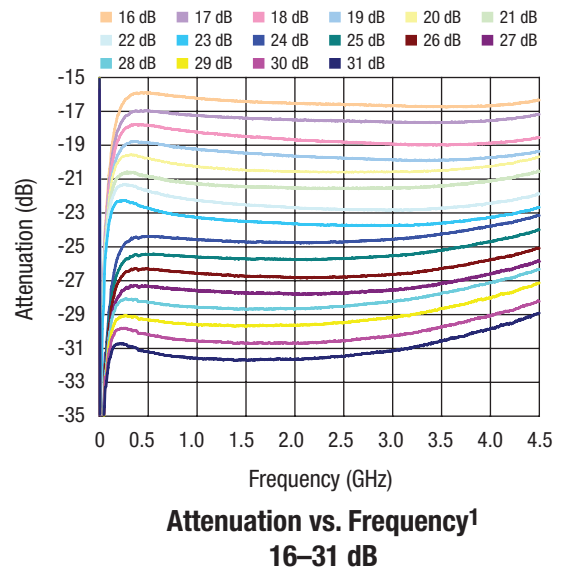
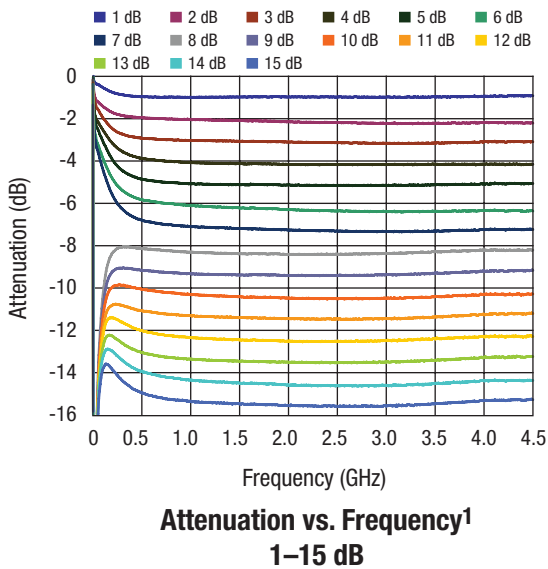
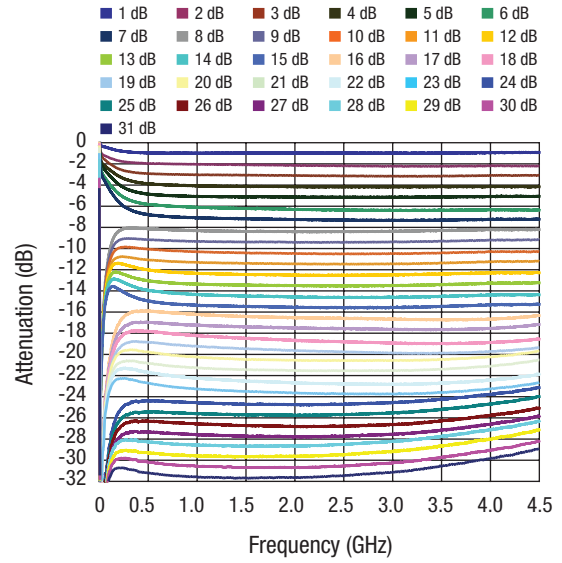
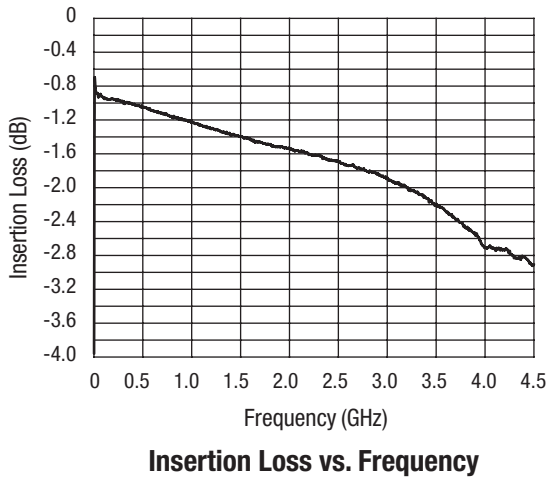

1. Attenuation normalized to insertion loss

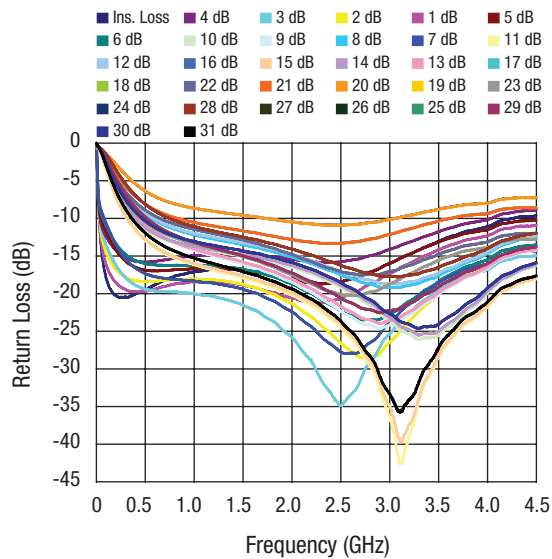

Input Return Loss vs. Frequency

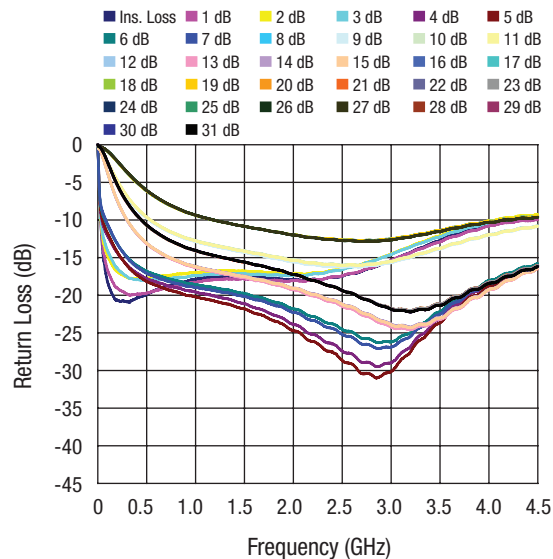

Output Return Loss vs. Frequency

Truth Table

V ₁	V ₂	V ₃	V ₄	V ₅	Attenuation
V _{HIGH}	V _{HIGH}	V _{HIGH}	V _{HIGH}	V _{HIGH}	Reference insertion loss
V _{LOW}	V _{HIGH}	V _{HIGH}	V _{HIGH}	V _{HIGH}	1 dB
V _{HIGH}	V _{LOW}	V _{HIGH}	V _{HIGH}	V _{HIGH}	2 dB
V _{HIGH}	V _{HIGH}	V _{LOW}	V _{HIGH}	V _{HIGH}	4 dB
V _{HIGH}	V _{HIGH}	V _{HIGH}	V _{LOW}	V _{HIGH}	8 dB
V _{HIGH}	V _{HIGH}	V _{HIGH}	V _{HIGH}	V _{LOW}	16 dB
V _{LOW}	V _{LOW}	V _{LOW}	V _{LOW}	V _{LOW}	31 dB

2.7 V ≤ V_{HIGH} ≤ 5.5 V, V_S = V_{HIGH} ± 0.2 V, 0 ≤ V_{LOW} ≤ 0.2 V.

Part Marking

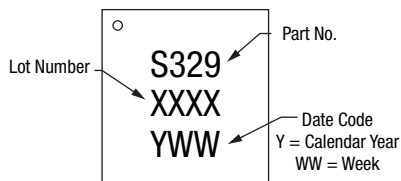

Absolute Maximum Ratings

Characteristic	Value
RF input power	33 dBm for f > 400 MHz, V _{CTL} = 0/8 V
Control voltage range	-0.2 ≤ V _C ≤ 8 V
Operating temperature range	-40 °C to +85 °C
Storage temperature range	-65 °C to +150 °C

Performance is guaranteed only under the conditions listed in the specifications table and is not guaranteed under the full range(s) described by the Absolute Maximum specifications. Exceeding any of the absolute maximum/minimum specifications may result in permanent damage to the device and will void the warranty.

CAUTION: Although this device is designed to be as robust as possible, ESD (Electrostatic Discharge) can damage this device. This device must be protected at all times from ESD. Static charges may easily produce potentials of several kilovolts on the human body or equipment, which can discharge without detection. Industry-standard ESD precautions must be employed at all times.

Recommended Solder Reflow Profiles

Refer to the [“Recommended Solder Reflow Profile”](#) Application Note.

Tape and Reel Information

Refer to the [“Discrete Devices and IC Switch/Attenuators Tape and Reel Package Orientation”](#) Application Note.

Pin Out

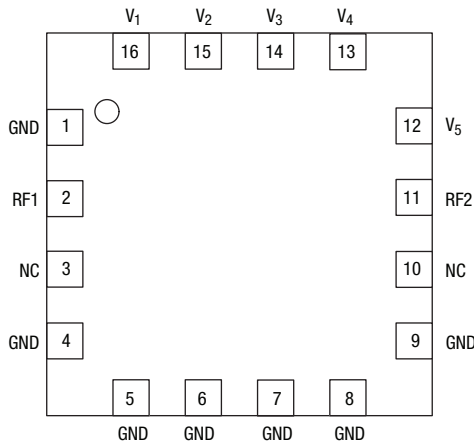

SKY12329-350LF Evaluation Circuit PCB

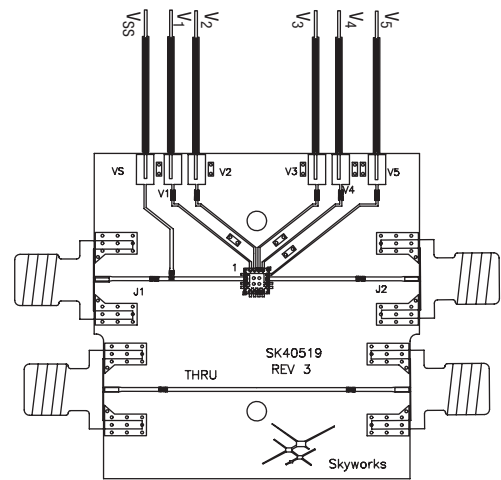

Pin Descriptions

Pin Number	Pin Name	Description
1, 4-9	GND	Equipotential Point—Equipotential points for control voltages and RF circuits. Must be connected to PCB ground via lowest possible
2	RF1	RF Input/Output—RF input or output port. A DC block is required for this port.
3, 10	N/C	No connection
11	RF2	RF Input/Output—RF input or output port. A DC block is required for this port.
12	V ₅	Control Voltage—Control voltage input for 16 dB weighted bit (MSB)
13	V ₄	Control Voltage—Control voltage input for 8 dB weighted bit
14	V ₃	Control Voltage—Control voltage input for 4 dB weighted bit
15	V ₂	Control Voltage—Control voltage input for 2 dB weighted bit
16	V ₁	Control Voltage—Control voltage input for 1 dB weighted bit (LSB)

SKY12329-350LF Evaluation Circuit

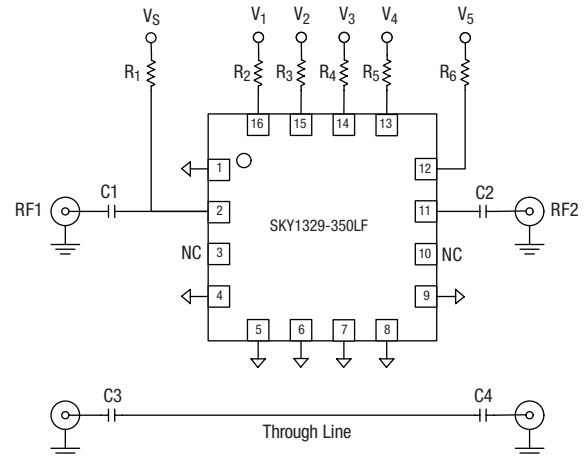

Evaluation Board

The evaluation board for SKY12329-350LF allows the part to be fully exercised. The insertion loss of the transmission lines between J₁–U₁ and U₁–J₂ can be determined by measuring the performance of the calibration through line, which contains two DC block capacitors (560 pF) in identical positions to the DC blocks present in the main circuit.

The state of the SKY12329-350LF is controlled by applying the appropriate logic level voltages to ports V₁ through V₅, per the Truth Table

Evaluation Board Components

Component	Description	Default
C ₁ –C ₄	DC blocking capacitor	560 pF, size 0402
R ₁	RF block	10k Ω, size 0402
R ₂ –R ₆	Current limiting	100 Ω
U ₁	SKY12329-350LF GaAs digital attenuator	
J ₁ , J ₂	SMA connectors	

CAUTION: Although this device is designed to be as robust as possible, ESD (Electrostatic Discharge) can damage this device. This device must be protected at all times from ESD. Static charges may easily produce potentials of several kilovolts on the human body or equipment, which can discharge without detection. Industry-standard ESD precautions must be employed at all times.

Land Pattern

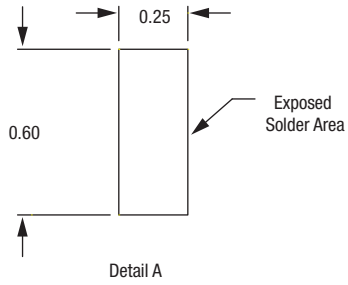
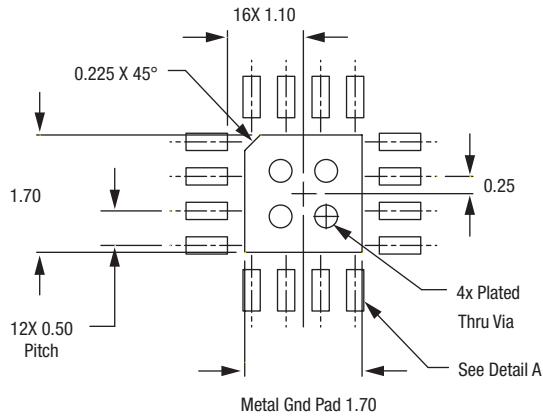

-350 (QFN 3 x 3)

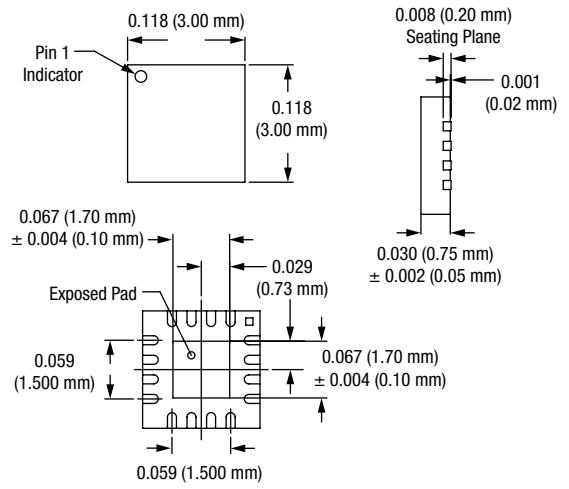

Copyright © 2007, 2008, 2009, Skyworks Solutions, Inc. All Rights Reserved.

Information in this document is provided in connection with Skyworks Solutions, Inc. ("Skyworks") products or services. These materials, including the information contained herein, are provided by Skyworks as a service to its customers and may be used for informational purposes only by the customer. Skyworks assumes no responsibility for errors or omissions in these materials or the information contained herein. Skyworks may change its documentation, products, services, specifications or product descriptions at any time, without notice. Skyworks makes no commitment to update the materials or information and shall have no responsibility whatsoever for conflicts, incompatibilities, or other difficulties arising from any future changes.

No license, whether express, implied, by estoppel or otherwise, is granted to any intellectual property rights by this document. Skyworks assumes no liability for any materials, products or information provided hereunder, including the sale, distribution, reproduction or use of Skyworks products, information or materials, except as may be provided in Skyworks Terms and Conditions of Sale.

THE MATERIALS, PRODUCTS AND INFORMATION ARE PROVIDED "AS IS" WITHOUT WARRANTY OF ANY KIND, WHETHER EXPRESS, IMPLIED, STATUTORY, OR OTHERWISE, INCLUDING FITNESS FOR A PARTICULAR PURPOSE OR USE, MERCHANTABILITY, PERFORMANCE, QUALITY OR NON-INFRINGEMENT OF ANY INTELLECTUAL PROPERTY RIGHT; ALL SUCH WARRANTIES ARE HEREBY EXPRESSLY DISCLAIMED. SKYWORKS DOES NOT WARRANT THE ACCURACY OR COMPLETENESS OF THE INFORMATION, TEXT, GRAPHICS OR OTHER ITEMS CONTAINED WITHIN THESE MATERIALS. SKYWORKS SHALL NOT BE LIABLE FOR ANY DAMAGES, INCLUDING BUT NOT LIMITED TO ANY SPECIAL, INDIRECT, INCIDENTAL, STATUTORY, OR CONSEQUENTIAL DAMAGES, INCLUDING WITHOUT LIMITATION, LOST REVENUES OR LOST PROFITS THAT MAY RESULT FROM THE USE OF THE MATERIALS OR INFORMATION, WHETHER OR NOT THE RECIPIENT OF MATERIALS HAS BEEN ADVISED OF THE POSSIBILITY OF SUCH DAMAGE.

Skyworks products are not intended for use in medical, lifesaving or life-sustaining applications, or other equipment in which the failure of the Skyworks products could lead to personal injury, death, physical or environmental damage. Skyworks customers using or selling Skyworks products for use in such applications do so at their own risk and agree to fully indemnify Skyworks for any damages resulting from such improper use or sale.

Customers are responsible for their products and applications using Skyworks products, which may deviate from published specifications as a result of design defects, errors, or operation of products outside of published parameters or design specifications. Customers should include design and operating safeguards to minimize these and other risks. Skyworks assumes no liability for applications assistance, customer product design, or damage to any equipment resulting from the use of Skyworks products outside of stated published specifications or parameters.

Skyworks, the Skyworks symbol, and "Breakthrough Simplicity" are trademarks or registered trademarks of Skyworks Solutions, Inc., in the United States and other countries. Third-party brands and names are for identification purposes only, and are the property of their respective owners. Additional information, including relevant terms and conditions, posted at www.skyworksinc.com, are incorporated by reference.