



EMIF04-VID01C2

4 LINES LOW CAPACITANCE EMI FILTER AND ESD PROTECTION

IPAD™

MAIN APPLICATION

Where EMI filtering in ESD sensitive equipment is required:

- LCD and camera for mobile phones
- Computers and printers
- Communication systems
- MCU board

DESCRIPTION

The EMIF04-VID01C2 is a 4 lines highly integrated array designed to suppress EMI / RFI noise in all systems subjected to electromagnetic interferences.

The EMIF04-VID01C2 Flip-Chip packaging means the package size is equal to the die size. Additionally, this filter includes an ESD protection circuitry which prevents the protected device from destruction when subjected to ESD surges up to 15 kV.

BENEFITS

- High efficiency EMI filtering (-40db @ 900MHz)
- Low line capacitance suitable for high speed data bus
- Low serial resistance for camera impedance adaptation
- Optimized PCB space consuming: 1.92mm x 1.29mm
- Very thin package: 0.69 mm
- High efficiency in ESD suppression on inputs pins (IEC61000-4-2 level 4)
- High reliability offered by monolithic integration
- High reducing of parasitic elements through integration & wafer level packaging
- Lead free package

COMPLIES WITH THE FOLLOWING STANDARDS: IEC61000-4-2

Level 4 on input pins 15kV (air discharge)
 8kV (contact discharge)

MIL STD 883E - Method 3015-6 Class 3

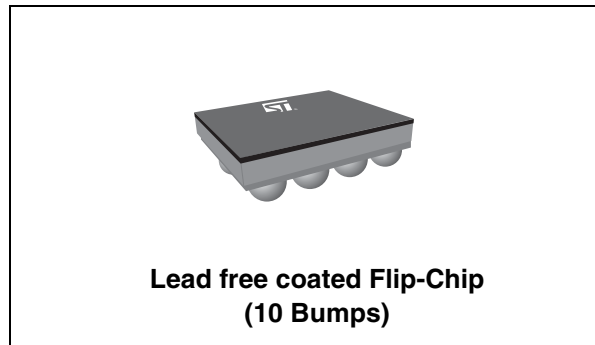

Table 1: Order Code

Part Number	Marking
EMIF04-VID01C2	GU

Figure 1: Pin Configuration (bump side)

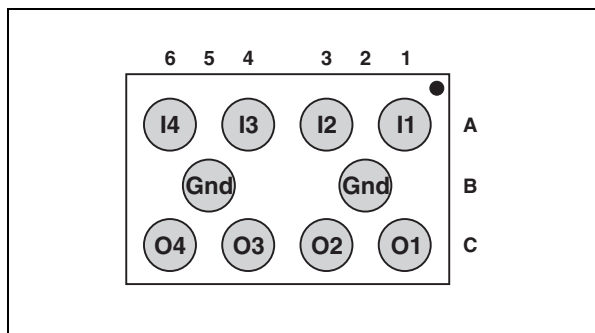
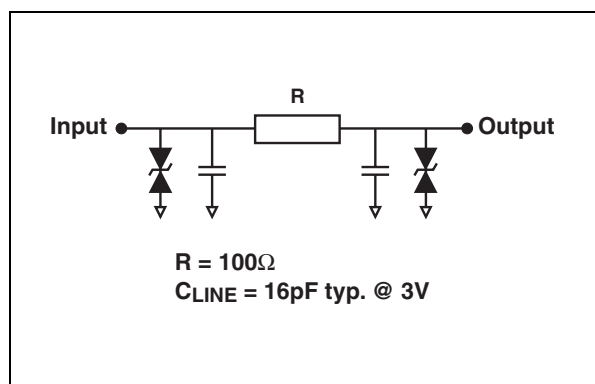

Figure 2: Configuration



TM: IPAD is a trademark of STMicroelectronics.

EMIF04-VID01C2

Table 2: Absolute Ratings (limiting values)

Symbol	Parameter and test conditions	Value	Unit
T_j	Maximum junction temperature	125	°C
T_{op}	Operating temperature range	- 40 to + 85	°C
T_{stg}	Storage temperature range	- 55 to + 150	°C

Table 3: Electrical Characteristics ($T_{amb} = 25^\circ\text{C}$)

Symbol	Parameter
V_{BR}	Breakdown voltage
I_{RM}	Leakage current @ V_{RM}
V_{RM}	Stand-off voltage
R	Series resistance between Input & Output
C_{line}	Input capacitance per line

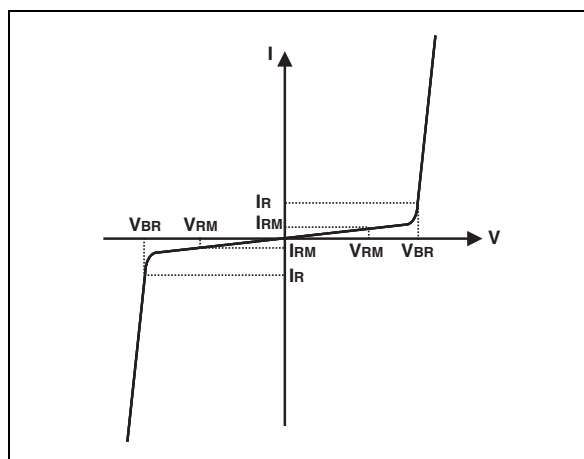

Symbol	Test conditions	Min.	Typ.	Max.	Unit
V_{BR}	$I_R = 1\text{mA}$	6	8	10	V
I_{RM}	$V_{RM} = 3\text{V per line}$			500	nA
R	$I = 10\text{mA}$	80	100	120	Ω
C_{line}	$V_R = 3\text{V DC}$ 1MHz $V_{OSC} = 30\text{mV}$		16	19	pF

Figure 3: S21 (dB) attenuation measurement

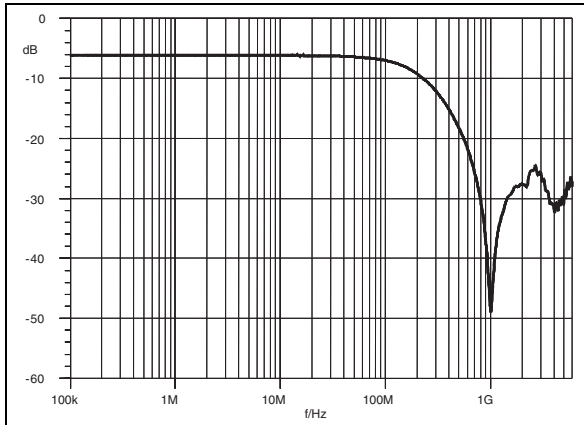

Figure 4: Analog crosstalk measurement

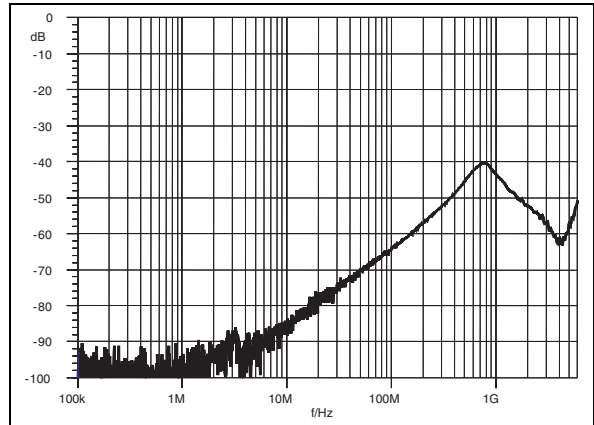

Figure 5: ESD response to IEC61000-4-2 (+15kV air discharge) on one input V(in) and on one output (Vout)

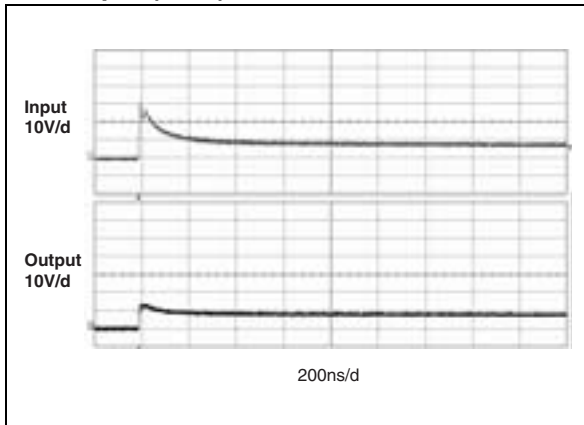

Figure 6: ESD response to IEC61000-4-2 (-15kV air discharge) on one input V(in) and on one output (Vout)

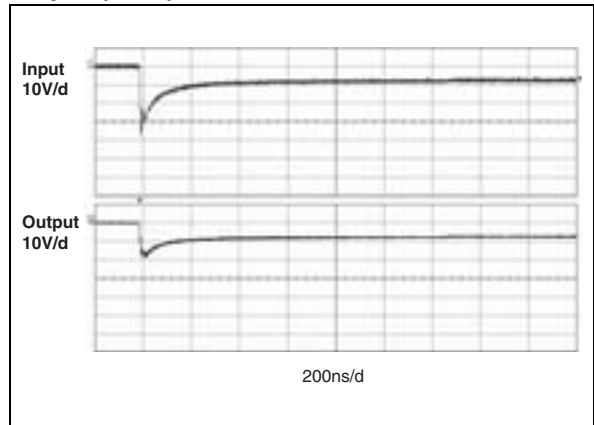

Figure 7: Junction capacitance versus reverse voltage applied (typical values)

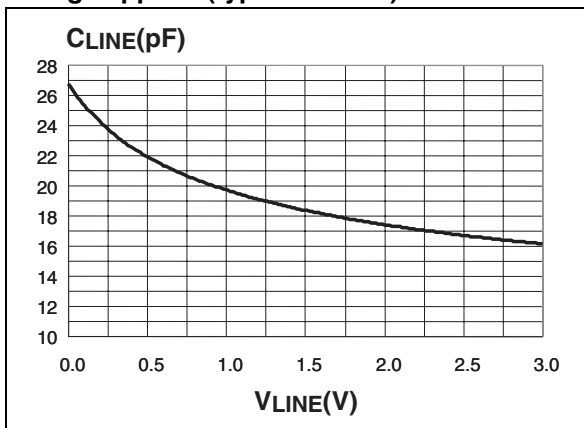

Figure 8: Ordering Information Scheme

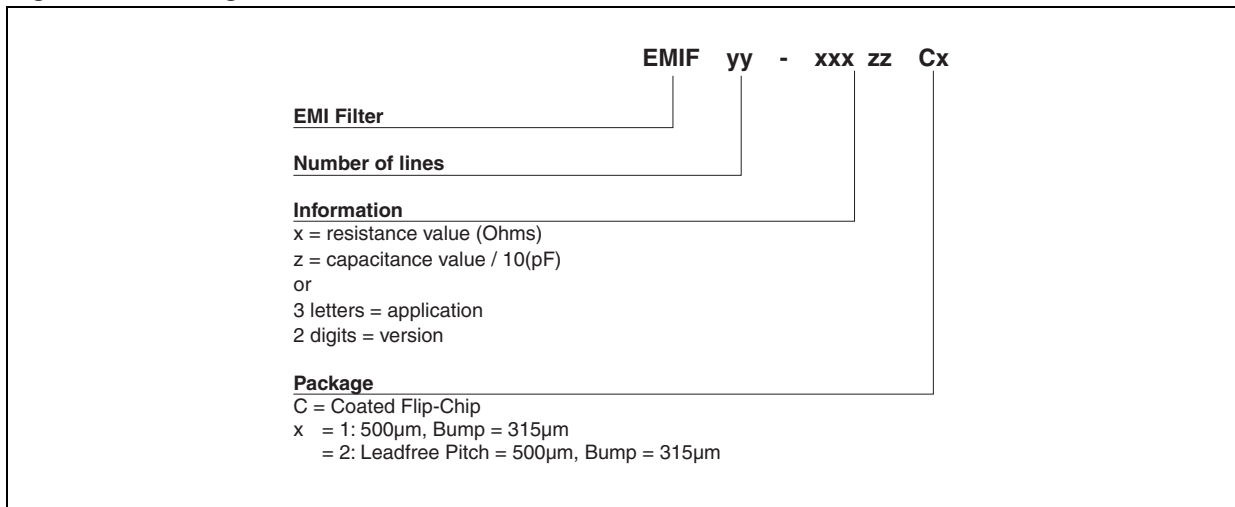

Figure 9: FLIP-CHIP Package Mechanical Data

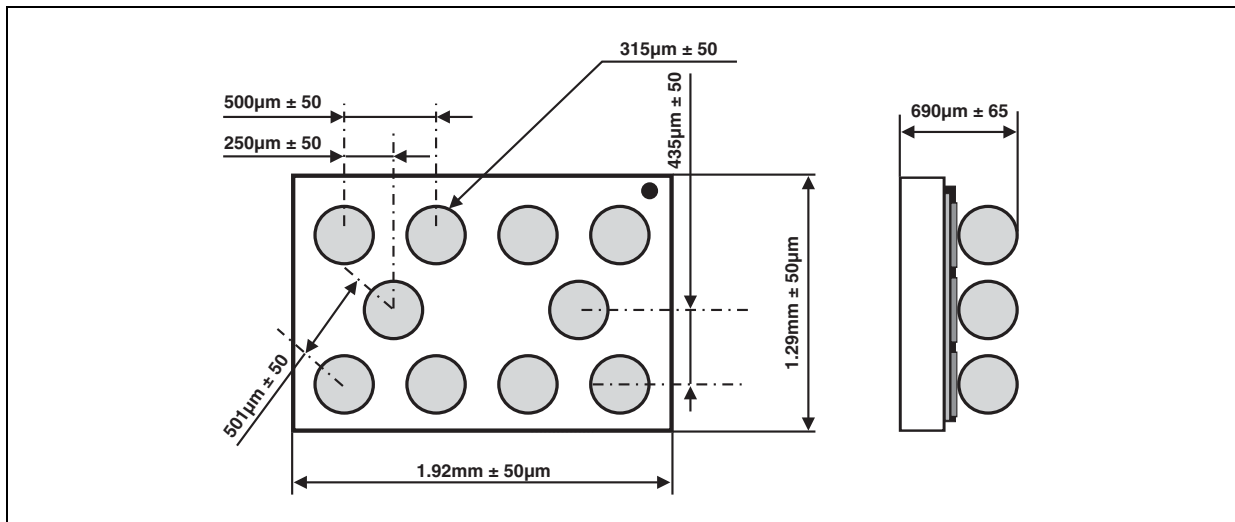

Figure 10: Foot Print Recommendations

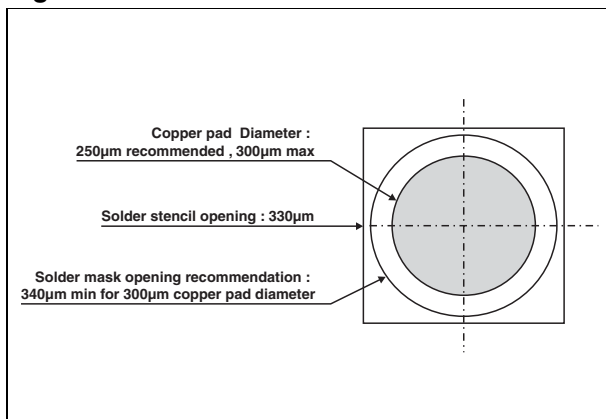

Figure 11: Marking

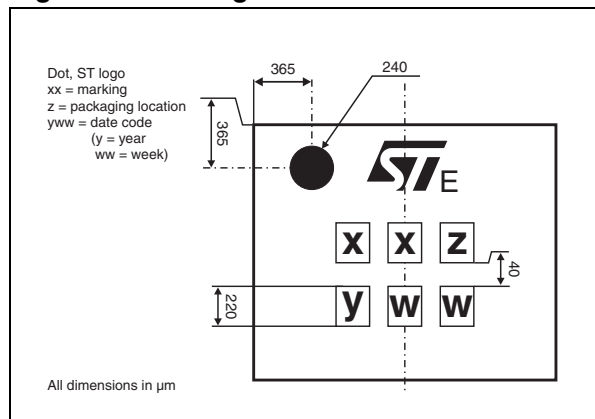
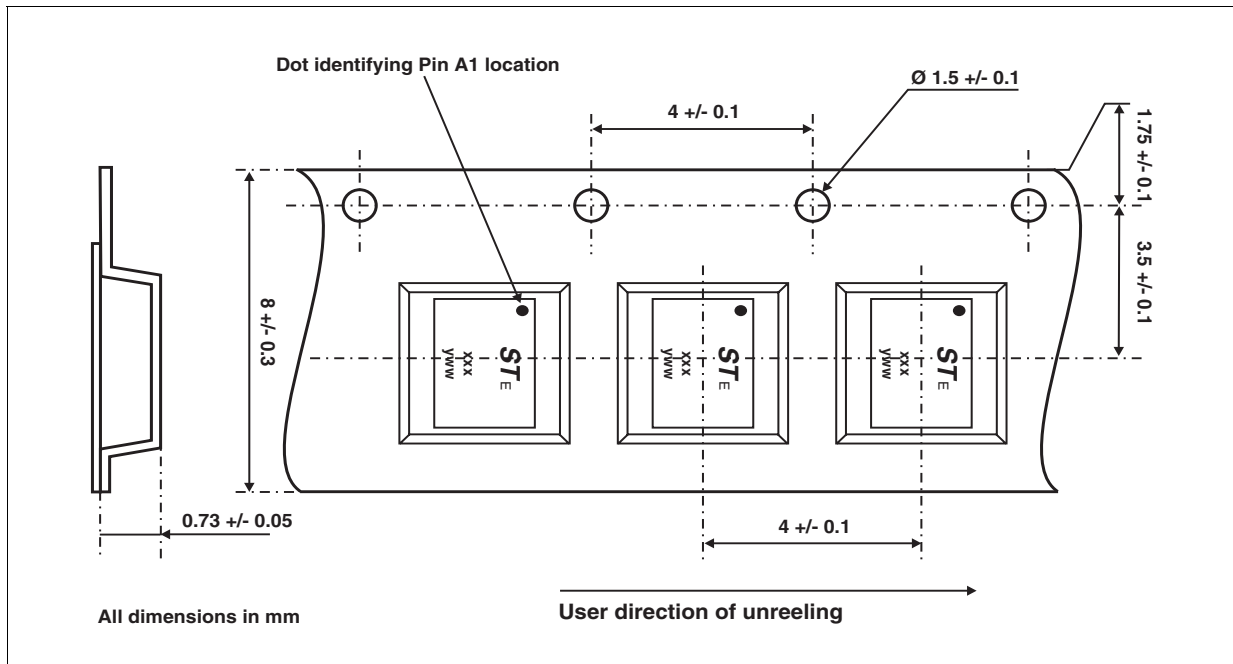

Figure 12: FLIP-CHIP Tape and Reel Specification



In order to meet environmental requirements, ST offers these devices in ECOPACK® packages. These packages have a Lead-free second level interconnect. The category of second level interconnect is marked on the package and on the inner box label, in compliance with JEDEC Standard JESD97. The maximum ratings related to soldering conditions are also marked on the inner box label. ECOPACK is an ST trademark. ECOPACK specifications are available at: www.st.com.

Table 4: Ordering Information

Ordering code	Marking	Package	Weight	Base qty	Delivery mode
EMIF04-VID01C2	GU	Flip-Chip	3.9 mg	5000	Tape & reel 7"

Note: More packing informations are available in the application note
 AN1235: "Flip-Chip: Package description and recommendations for use"
 AN1751: "EMI Filters: Recommendations and measurements"

Table 5: Revision History

Date	Revision	Description of Changes
12-Aug-2005	1	First issue.

Information furnished is believed to be accurate and reliable. However, STMicroelectronics assumes no responsibility for the consequences of use of such information nor for any infringement of patents or other rights of third parties which may result from its use. No license is granted by implication or otherwise under any patent or patent rights of STMicroelectronics. Specifications mentioned in this publication are subject to change without notice. This publication supersedes and replaces all information previously supplied. STMicroelectronics products are not authorized for use as critical components in life support devices or systems without express written approval of STMicroelectronics.

The ST logo is a registered trademark of STMicroelectronics.
All other names are the property of their respective owners

© 2005 STMicroelectronics - All rights reserved

STMicroelectronics group of companies

Australia - Belgium - Brazil - Canada - China - Czech Republic - Finland - France - Germany - Hong Kong - India - Israel - Italy - Japan -
Malaysia - Malta - Morocco - Singapore - Spain - Sweden - Switzerland - United Kingdom - United States of America
www.st.com