

## Very low quiescent current dual voltage regulator

### Features

- $V_{O1}$ : fixed
- $V_{O2}$ : adjustable from 1.25 to  $V_I - V_{DROP}$
- Guaranteed current of output 1: 1 A
- Guaranteed current of output 2: 1 A
- $\pm 2\%$  output tolerance (at 25 °C)
- $\pm 3\%$  output tolerance at overtemperature
- Typical dropout 1.1 V ( $I_{O1} = I_{O2} = 1$  A)
- Internal power and thermal limit
- Good stability with low ESR output capacitor
- Operating temperature range: 0 °C to 125 °C
- Very low quiescent current: 7 mA max overtemperature
- Available in DFN8 5x6 mm package

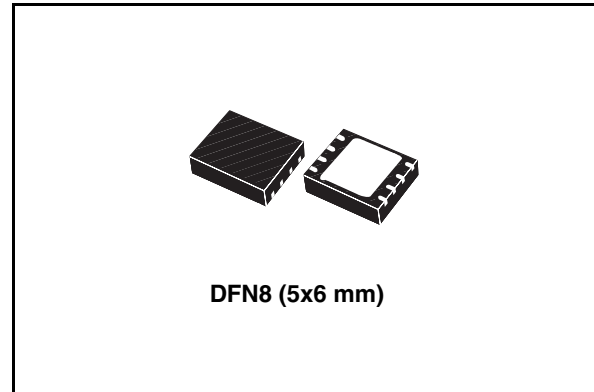

and overtemperature protected. Also noteworthy is the very good thermal performance of the DFN8 package, with only 2 °C/W of thermal resistance junction-to-case.

### Applications

- Hard disk drives
- CD/DVD-ROMs
- CD/DVD-R/RWs
- COMBO® (DVD-ROM+CD-R/RW)

### Description

Specifically designed for data storage applications, this device integrates two voltage regulators, each capable of supplying 1 A of current. It is assembled in an 8-pin DFN8 5x6 mm surface mounting package. One regulator block supplies 3.3 V and, on request, 1.5 V, 1.8 V, 2.5 V, 2.8 V and 3.0 V. The other is adjustable from 1.25 V to  $V_I - V_{DROP}$  which is suitable for powering several different types of microcontroller. Both outputs are current-limited

**Table 1. Device summary**

Order code	Package	Output voltage
ST2L05R3300PS	DFN8 (5x6 mm)	Adjustable

# Contents

1	<b>Block diagram</b> .....	3
2	<b>Pin configuration</b> .....	4
3	<b>Maximum ratings</b> .....	5
4	<b>Application circuits</b> .....	6
5	<b>Electrical characteristics</b> .....	7
6	<b>Application hints</b> .....	15
	6.1 External capacitors .....	15
	6.2 Input capacitor .....	15
	6.3 Output capacitor .....	15
	6.4 Adjustable regulator .....	15
7	<b>Typical characteristics</b> .....	17
8	<b>Package mechanical data</b> .....	24
9	<b>Different output voltage versions of the ST2L05-3300 available on request</b> .....	27
10	<b>Revision history</b> .....	28



## 2 Pin configuration

Figure 2. Pin connection (top through view)

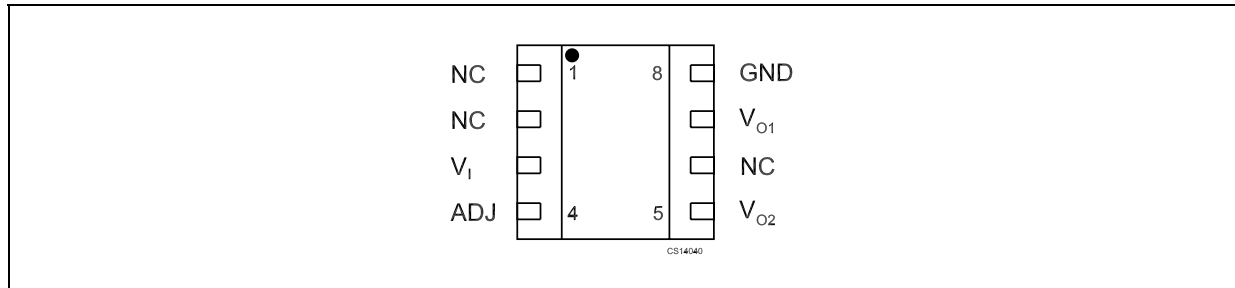

Table 2. Pin description

Pin n°	Symbol	Name and function
3	$V_I$	Bypass with a 4.7 $\mu$ F capacitor to GND
4	ADJ	Resistor divider connection
8	GND	Ground
5	$V_{O2}$	Adjustable output voltage: bypass with a 4.7 $\mu$ F capacitor to GND
7	$V_{O1}$	Fixed output voltage: bypass with a 4.7 $\mu$ F capacitor to GND
1, 2, 6	NC	Not connected

### 3 Maximum ratings

**Table 3. Absolute maximum ratings**

Symbol	Parameter	Value	Unit
$V_I$	Operating input voltage	10	V
$P_D$	Power dissipation	Internally limited	
$I_{OSH}$	Short circuit output current - 3.3 V and adjustable output	Internally limited	
$T_{OP}$	Operating junction temperature range	0 to 150	°C
$T_{STG}$	Storage temperature range <sup>(1)</sup>	- 65 to 150	°C
$T_{LEAD}$	Lead temperature (soldering) 10 sec.	260	°C

1. Storage temperatures > 125°C are only acceptable if the dual regulator is soldered to a PCBA.

*Note: Absolute maximum ratings are those values beyond which damage to the device may occur. Functional operation under these condition is not implied.*

**Table 4. Recommended operating conditions**

Symbol	Parameter	Value	Unit
$V_I$	Input voltage	4.5 to 7	V
$\Delta V_I$	Input voltage ripple	± 0.15	V
$t_{RISE}$	Input voltage rise time (from 10% to 90%)	≥ 1	µs
$t_{FALL}$	Input voltage fall time (from 10% to 90%)	≥ 1	µs

**Table 5. Thermal data**

Symbol	Parameter	Value	Unit
$R_{thJC}$	Thermal resistance junction-case	2	°C/W
$R_{thJA}$	Thermal resistance junction-ambient	36	°C/W

## 4 Application circuits

Figure 3. Application circuit of fixed / adj. version (1)

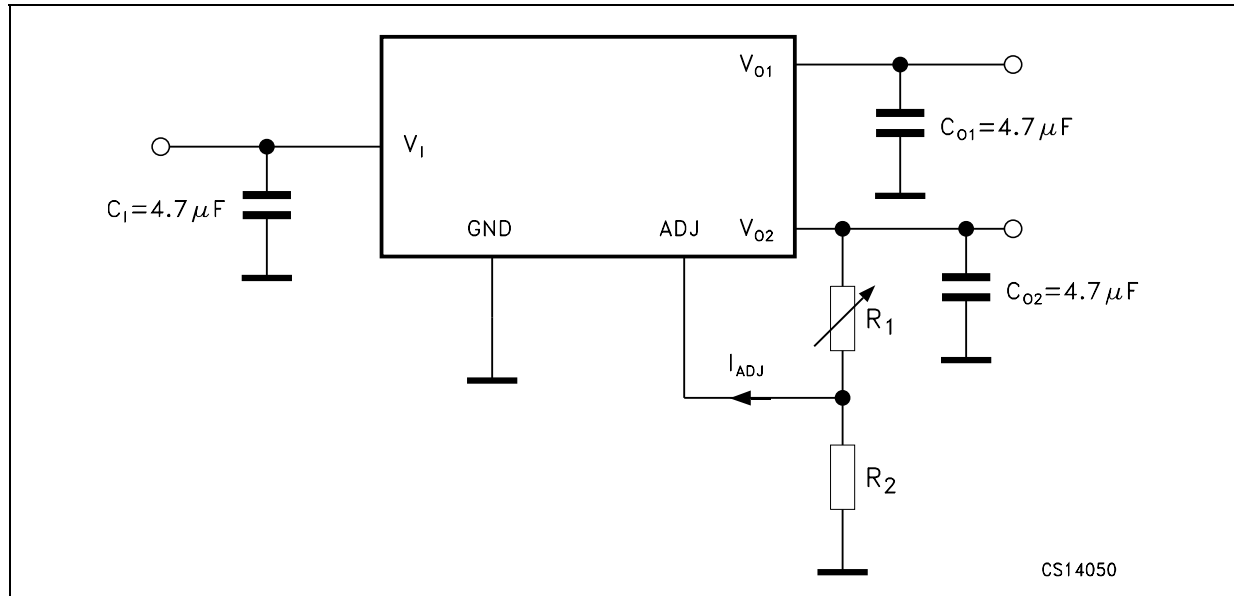

1. In the fixed / adj. version, the adjustable output voltage  $V_{O2}$  is designed to support output voltages from 1.25 V to  $V_1 - V_{DROD}$ . The adjustable output voltage  $V_{O2}$  is set using a resistor divider connected between  $V_{O2}$  (pin 4) and ground (pin 3) with its center tap connected to  $V_{O2}$  ADJ (pin 2). The voltage divider resistors are:  $R_1$  connected to  $V_{O2}$  and  $V_{O2}$  ADJ and  $R_2$  connected to  $V_{O2}$  ADJ and GND.  $V_{O2}$  is determined by  $V_{REF}$ ,  $R_1$ ,  $R_2$ , and  $I_{ADJ}$  as follows (for more details see the application hints section):  

$$V_{O2} = V_{REF} (1 + R_1 / R_2) + I_{ADJ} R_1$$

## 5 Electrical characteristics

$I_O = 10 \text{ mA to } 1 \text{ A}$ ,  $T_J = 0 \text{ to } 125 \text{ }^\circ\text{C}$ ,  $V_I = 4.5 \text{ V to } 7 \text{ V}$ ,  $C_I = 4.7 \text{ } \mu\text{F}$ ,  $C_{O1} = C_{O2} = 4.7 \text{ } \mu\text{F}$ , unless otherwise specified.

**Table 6. Output 1 and output 2 dual specification**

Symbol	Parameter	Test conditions	Min.	Typ.	Max.	Unit
$I_{\text{GND}}$	Quiescent current (fixed / adj.)	$V_I \leq 7 \text{ V}$ , $I_{\text{OUT}1,2} = 5 \text{ mA to } 1 \text{ A}$			5	mA
$I_{\text{ST}}$	Total current limit $I_{O1} + I_{O2}$		2			A
$T_{\text{SHDN}}$	Thermal shutdown			175		$^\circ\text{C}$
$DT_{\text{SHDN}}$	Thermal shutdown hysteresis			5		$^\circ\text{C}$

$I_O = 10 \text{ mA to } 1 \text{ A}$ ,  $T_J = 0 \text{ to } 125 \text{ }^\circ\text{C}$ ,  $V_I = 4.5 \text{ V to } 7 \text{ V}$ ,  $C_I = 4.7 \text{ } \mu\text{F}$ ,  $C_{O1} = C_{O2} = 4.7 \text{ } \mu\text{F}$ , unless otherwise specified.

**Table 7. Electrical characteristics of fixed output 1.5 V**

Symbol	Parameter	Test conditions	Min.	Typ.	Max.	Unit
$V_O$	Output voltage 1.5V	$I_O = 5\text{mA to } 1\text{A}$ , $V_I = 4.75 \text{ to } 5.25\text{V}$ $T = 25^\circ\text{C}$	1.47	1.5	1.53	V
$V_O$	Output voltage 1.5V	$I_O = 5\text{mA to } 1\text{A}$ , $V_I = 4.75 \text{ to } 5.25\text{V}$	1.455	1.5	1.545	V
$\Delta V_O$	Line regulation	$V_I = 4.75 \text{ to } 5.25\text{V}$ , $I_O = 5\text{mA to } 1\text{A}$			15	mV
$\Delta V_O$	Load regulation	$V_I = 4.75\text{V}$ , $I_O = 10\text{mA to } 1\text{A}$			12	mV
$V_D$	Dropout voltage $\Delta V_O = -1\%$	$I_O = 1\text{A}$			1.3	V
$I_S$	Current limit	$V_I = 5.5\text{V}$	1			A
$I_{O\text{MIN}}$	Min. output current for regulation				0	mA
$e_N$	RMS output noise <sup>(1) (5)</sup>	$T = 25^\circ\text{C}$		0.003		%
SVR	Supply voltage rejection <sup>(2)(5)</sup>	$V_I = 5\text{V}$	60			dB
$\Delta V_O/\Delta I_O$	Transient response change of $V_O$ with step load change <sup>(3)(5)</sup>	$V_I = 5\text{V}$ , $I_O = 1\text{mA to } 1\text{A}$ , $t_r \geq 1\mu\text{s}$			$10^{(4)}$	%
		$V_I = 5\text{V}$ , $I_O = 1\text{A to } 1\text{mA}$ , $t_r \geq 1\mu\text{s}$			$10^{(4)}$	
$\Delta V_{O1}/\Delta V_I$	Transient response change of $V_{O\text{UT}1}$ with application of $V_I$ <sup>(3)(5)</sup>	0 to 5V step input, $I_O = 1\text{mA to } 1\text{A}$ , $t_r \geq 1\mu\text{s}$			$10^{(4)}$	%
$\Delta V_O/\Delta I_O$	Transient response short circuit removal response <sup>(3)(5)</sup>	$V_I = 5\text{V}$ , $I_O = \text{short to } I_O = 10\text{mA}$			$20^{(4)}$	%
$T_R$	Thermal regulation <sup>(5)</sup>	$I_O = 1\text{A}$ , $t_{\text{PULSE}} = 30\text{ms}$		0.1		%/W
S	Temperature stability <sup>(5)</sup>			0.5		%
S	Long-term stability <sup>(5)</sup> (1000hrs)	$T_J = 125^\circ\text{C}$		0.3		%

1. Bandwidth of 10 Hz to 10 kHz.
2. 120 Hz input ripple.
3.  $C_I = 20 \text{ } \mu\text{F}$ ,  $C_{O1}$  and  $C_{O2} = 10 \text{ } \mu\text{F}$ .  $C_I$ ,  $C_{O1}$  and  $C_{O2}$  are all X7R ceramic capacitors.
4. % undershoot or overshoot of  $V_O$
5. Guaranteed by design, not tested in production.



$I_O = 10 \text{ mA to } 1 \text{ A}$ ,  $T_J = 0 \text{ to } 125 \text{ }^\circ\text{C}$ ,  $V_I = 4.5 \text{ V to } 7 \text{ V}$ ,  $C_I = 4.7 \text{ } \mu\text{F}$ ,  $C_{O1} = C_{O2} = 4.7 \text{ } \mu\text{F}$ , unless otherwise specified.

**Table 8. Electrical characteristics of fixed output 1.8 V**

Symbol	Parameter	Test conditions	Min.	Typ.	Max.	Unit
$V_O$	Output voltage 1.8V	$I_O = 5\text{mA to } 1\text{A}$ , $V_I = 4.75 \text{ to } 5.25\text{V}$ $T = 25^\circ\text{C}$	1.764	1.8	1.836	V
$V_O$	Output voltage 1.8V	$I_O = 5\text{mA to } 1\text{A}$ , $V_I = 4.75 \text{ to } 5.25\text{V}$	1.746	1.8	1.854	V
$\Delta V_O$	Line regulation	$V_I = 4.75 \text{ to } 5.25\text{V}$ , $I_O = 5\text{mA to } 1\text{A}$			15	mV
$\Delta V_O$	Load regulation	$V_I = 4.75\text{V}$ , $I_O = 10\text{mA to } 1\text{A}$			12	mV
$V_D$	Dropout voltage $\Delta V_O = -1\%$	$I_O = 1\text{A}$			1.3	V
$I_S$	Current limit	$V_I = 5.5\text{V}$	1			A
$I_{O\text{MIN}}$	Min. output current for regulation				0	mA
$e_N$	RMS output noise <sup>(1) (5)</sup>	$T = 25^\circ\text{C}$		0.003		%
SVR	Supply voltage rejection <sup>(2)(5)</sup>	$V_I = 5\text{V}$	60			dB
$\Delta V_O/\Delta I_O$	Transient response change of $V_O$ with step load change <sup>(3)(5)</sup>	$V_I = 5\text{V}$ , $I_O = 1\text{mA to } 1\text{A}$ , $t_r \geq 1\mu\text{s}$			$10^{(4)}$	%
		$V_I = 5\text{V}$ , $I_O = 1\text{A to } 1\text{mA}$ , $t_r \geq 1\mu\text{s}$			$10^{(4)}$	
$\Delta V_{O1}/\Delta V_I$	Transient response change of $V_{O\text{UT}1}$ with application of $V_I$ <sup>(3)(5)</sup>	0 to 5V step input, $I_O = 1\text{mA to } 1\text{A}$ , $t_r \geq 1\mu\text{s}$			$10^{(4)}$	%
$\Delta V_O/\Delta I_O$	Transient response short circuit removal response <sup>(3)(5)</sup>	$V_I = 5\text{V}$ , $I_O = \text{short to } I_O = 10\text{mA}$			$20^{(4)}$	%
$T_R$	Thermal regulation <sup>(5)</sup>	$I_O = 1\text{A}$ , $t_{\text{PULSE}} = 30\text{ms}$		0.1		%/W
S	Temperature stability <sup>(5)</sup>			0.5		%
S	Long-term stability <sup>(5)</sup> (1000hrs)	$T_J = 125^\circ\text{C}$		0.3		%

1. Bandwidth of 10 Hz to 10 kHz.
2. 120 Hz input ripple.
3.  $C_I = 20 \text{ } \mu\text{F}$ ,  $C_{O1}$  and  $C_{O2} = 10 \text{ } \mu\text{F}$ .  $C_I$ ,  $C_{O1}$  and  $C_{O2}$  are all X7R ceramic capacitors.
4. % undershoot or overshoot of  $V_O$
5. Guaranteed by design, not tested in production.

$I_O = 10 \text{ mA to } 1 \text{ A}$ ,  $T_J = 0 \text{ to } 125 \text{ }^\circ\text{C}$ ,  $V_I = 4.5 \text{ V to } 7 \text{ V}$ ,  $C_I = 4.7 \text{ } \mu\text{F}$ ,  $C_{O1} = C_{O2} = 4.7 \text{ } \mu\text{F}$ , unless otherwise specified.

**Table 9. Electrical characteristics of fixed output 2.5 V**

Symbol	Parameter	Test conditions	Min.	Typ.	Max.	Unit
$V_O$	Output voltage 2.5V	$I_O = 5\text{mA to } 1\text{A}$ , $V_I = 4.75 \text{ to } 5.25\text{V}$ $T = 25^\circ\text{C}$	2.45	2.5	2.55	V
$V_O$	Output voltage 2.5V	$I_O = 5\text{mA to } 1\text{A}$ , $V_I = 4.75 \text{ to } 5.25\text{V}$	2.425	2.5	2.575	V
$\Delta V_O$	Line regulation	$V_I = 4.75 \text{ to } 5.25\text{V}$ , $I_O = 5\text{mA to } 1\text{A}$			15	mV
$\Delta V_O$	Load regulation	$V_I = 4.75\text{V}$ , $I_O = 10\text{mA to } 1\text{A}$			12	mV
$V_D$	Dropout voltage $\Delta V_O = -1\%$	$I_O = 1\text{A}$			1.3	V
$I_S$	Current limit	$V_I = 5.5\text{V}$	1			A
$I_{O\text{MIN}}$	Min. output current for regulation				0	mA
$e_N$	RMS output noise <sup>(1) (5)</sup>	$T = 25^\circ\text{C}$		0.003		%
SVR	Supply voltage rejection <sup>(2)(5)</sup>	$V_I = 5\text{V}$	60			dB
$\Delta V_O/\Delta I_O$	Transient response change of $V_O$ with step load change <sup>(3)(5)</sup>	$V_I = 5\text{V}$ , $I_O = 1\text{mA to } 1\text{A}$ , $t_r \geq 1\mu\text{s}$			$10^{(4)}$	%
		$V_I = 5\text{V}$ , $I_O = 1\text{A to } 1\text{mA}$ , $t_r \geq 1\mu\text{s}$			$10^{(4)}$	
$\Delta V_{O1}/\Delta V_I$	Transient response change of $V_{OUT1}$ with application of $V_I$ <sup>(3)(5)</sup>	0 to 5V step input, $I_O = 1\text{mA to } 1\text{A}$ , $t_r \geq 1\mu\text{s}$			$10^{(4)}$	%
$\Delta V_O/\Delta I_O$	Transient response short circuit removal response <sup>(3)(5)</sup>	$V_I = 5\text{V}$ , $I_O = \text{short to } I_O = 10\text{mA}$			$20^{(4)}$	%
$T_R$	Thermal regulation <sup>(5)</sup>	$I_O = 1\text{A}$ , $t_{\text{PULSE}} = 30\text{ms}$		0.1		%/W
S	Temperature stability <sup>(5)</sup>			0.5		%
S	Long-term stability <sup>(5)</sup> (1000hrs)	$T_J = 125^\circ\text{C}$		0.3		%

1. Bandwidth of 10 Hz to 10 kHz.
2. 120 Hz input ripple.
3.  $C_I = 20 \text{ } \mu\text{F}$ ,  $C_{O1}$  and  $C_{O2} = 10 \text{ } \mu\text{F}$ .  $C_I$ ,  $C_{O1}$  and  $C_{O2}$  are all X7R ceramic capacitors.
4. % undershoot or overshoot of  $V_O$
5. Guaranteed by design, not tested in production.

$I_O = 10 \text{ mA to } 1 \text{ A}$ ,  $T_J = 0 \text{ to } 125 \text{ }^\circ\text{C}$ ,  $V_I = 4.5 \text{ V to } 7 \text{ V}$ ,  $C_I = 4.7 \text{ } \mu\text{F}$ ,  $C_{O1} = C_{O2} = 4.7 \text{ } \mu\text{F}$ , unless otherwise specified.

**Table 10. Electrical characteristics of fixed output 2.8 V**

Symbol	Parameter	Test conditions	Min.	Typ.	Max.	Unit
$V_O$	Output voltage 2.8V	$I_O = 5\text{mA to } 1\text{A}$ , $V_I = 4.75 \text{ to } 5.25\text{V}$ $T = 25^\circ\text{C}$	2.744	2.8	2.856	V
$V_O$	Output voltage 2.8V	$I_O = 5\text{mA to } 1\text{A}$ , $V_I = 4.75 \text{ to } 5.25\text{V}$	2.716	2.8	2.884	V
$\Delta V_O$	Line regulation	$V_I = 4.75 \text{ to } 5.25\text{V}$ , $I_O = 5\text{mA to } 1\text{A}$			15	mV
$\Delta V_O$	Load regulation	$V_I = 4.75\text{V}$ , $I_O = 10\text{mA to } 1\text{A}$			12	mV
$V_D$	Dropout voltage $\Delta V_O = -1\%$	$I_O = 1\text{A}$			1.3	V
$I_S$	Current limit	$V_I = 5.5\text{V}$	1			A
$I_{O\text{MIN}}$	Min. output current for regulation				0	mA
$e_N$	RMS output noise <sup>(1) (5)</sup>	$T = 25^\circ\text{C}$		0.003		%
SVR	Supply voltage rejection <sup>(2)(5)</sup>	$V_I = 5\text{V}$	60			dB
$\Delta V_O/\Delta I_O$	Transient response change of $V_O$ with step load change <sup>(3)(5)</sup>	$V_I = 5\text{V}$ , $I_O = 1\text{mA to } 1\text{A}$ , $t_r \geq 1\text{ } \mu\text{s}$			$10^{(4)}$	%
		$V_I = 5\text{V}$ , $I_O = 1\text{A to } 1\text{mA}$ , $t_r \geq 1\text{ } \mu\text{s}$			$10^{(4)}$	
$\Delta V_{O1}/\Delta V_I$	Transient response change of $V_{O\text{UT}1}$ with application of $V_I$ <sup>(3)(5)</sup>	0 to 5V step input, $I_O = 1\text{mA to } 1\text{A}$ , $t_r \geq 1\text{ } \mu\text{s}$			$10^{(4)}$	%
$\Delta V_O/\Delta I_O$	Transient response short circuit removal response <sup>(3)(5)</sup>	$V_I = 5\text{V}$ , $I_O = \text{short to } I_O = 10\text{mA}$			$20^{(4)}$	%
$T_R$	Thermal regulation <sup>(5)</sup>	$I_O = 1\text{A}$ , $t_{\text{PULSE}} = 30\text{ms}$		0.1		%/W
S	Temperature stability <sup>(5)</sup>			0.5		%
S	Long-term stability <sup>(5)</sup> (1000hrs)	$T_J = 125^\circ\text{C}$		0.3		%

1. Bandwidth of 10 Hz to 10 kHz.
2. 120 Hz input ripple.
3.  $C_I = 20 \text{ } \mu\text{F}$ ,  $C_{O1}$  and  $C_{O2} = 10 \text{ } \mu\text{F}$ .  $C_I$ ,  $C_{O1}$  and  $C_{O2}$  are all X7R ceramic capacitors.
4. % undershoot or overshoot of  $V_O$
5. Guaranteed by design, not tested in production.

$I_O = 10 \text{ mA to } 1 \text{ A}$ ,  $T_J = 0 \text{ to } 125 \text{ }^\circ\text{C}$ ,  $V_I = 4.5 \text{ V to } 7 \text{ V}$ ,  $C_I = 4.7 \text{ } \mu\text{F}$ ,  $C_{O1} = C_{O2} = 4.7 \text{ } \mu\text{F}$ , unless otherwise specified.

**Table 11. Electrical characteristics of fixed output 3.0 V**

Symbol	Parameter	Test conditions	Min.	Typ.	Max.	Unit
$V_O$	Output voltage 3.0V	$I_O = 5\text{mA to } 1\text{A}$ , $V_I = 4.75 \text{ to } 5.25\text{V}$ $T = 25^\circ\text{C}$	2.94	3.0	3.06	V
$V_O$	Output voltage 3.0V	$I_O = 5\text{mA to } 1\text{A}$ , $V_I = 4.75 \text{ to } 5.25\text{V}$	2.91	3.0	3.09	V
$\Delta V_O$	Line regulation	$V_I = 4.75 \text{ to } 5.25\text{V}$ , $I_O = 5\text{mA to } 1\text{A}$			15	mV
$\Delta V_O$	Load regulation	$V_I = 4.75\text{V}$ , $I_O = 10\text{mA to } 1\text{A}$			12	mV
$V_D$	Dropout voltage $\Delta V_O = -1\%$	$I_O = 1\text{A}$			1.3	V
$I_S$	Current limit	$V_I = 5.5\text{V}$	1			A
$I_{O\text{MIN}}$	Min. output current for regulation				0	mA
$e_N$	RMS output noise <sup>(1) (5)</sup>	$T = 25^\circ\text{C}$		0.003		%
SVR	Supply voltage rejection <sup>(2)(5)</sup>	$V_I = 5\text{V}$	60			dB
$\Delta V_O/\Delta I_O$	Transient response change of $V_O$ with step load change <sup>(3)(5)</sup>	$V_I = 5\text{V}$ , $I_O = 1\text{mA to } 1\text{A}$ , $t_r \geq 1\mu\text{s}$			$10^{(4)}$	%
		$V_I = 5\text{V}$ , $I_O = 1\text{A to } 1\text{mA}$ , $t_r \geq 1\mu\text{s}$			$10^{(4)}$	
$\Delta V_{O1}/\Delta V_I$	Transient response change of $V_{O\text{UT}1}$ with application of $V_I$ <sup>(3)(5)</sup>	0 to 5V step input, $I_O = 1\text{mA to } 1\text{A}$ , $t_r \geq 1\mu\text{s}$			$10^{(4)}$	%
$\Delta V_O/\Delta I_O$	Transient response short circuit removal response <sup>(3)(5)</sup>	$V_I = 5\text{V}$ , $I_O = \text{short to } I_O = 10\text{mA}$			$20^{(4)}$	%
$T_R$	Thermal regulation <sup>(5)</sup>	$I_O = 1\text{A}$ , $t_{\text{PULSE}} = 30\text{ms}$		0.1		%/W
S	Temperature stability <sup>(5)</sup>			0.5		%
S	Long-term stability <sup>(5)</sup> (1000hrs)	$T_J = 125^\circ\text{C}$		0.3		%

1. Bandwidth of 10 Hz to 10 kHz.
2. 120 Hz input ripple.
3.  $C_I = 20 \text{ } \mu\text{F}$ ,  $C_{O1}$  and  $C_{O2} = 10 \text{ } \mu\text{F}$ .  $C_I$ ,  $C_{O1}$  and  $C_{O2}$  are all X7R ceramic capacitors.
4. % undershoot or overshoot of  $V_O$
5. Guaranteed by design, not tested in production.

$I_O = 10 \text{ mA to } 1 \text{ A}$ ,  $T_J = 0 \text{ to } 125 \text{ }^\circ\text{C}$ ,  $V_I = 4.5 \text{ V to } 7 \text{ V}$ ,  $C_I = 4.7 \text{ } \mu\text{F}$ ,  $C_{O1} = C_{O2} = 4.7 \text{ } \mu\text{F}$ , unless otherwise specified.

**Table 12. Electrical characteristics of fixed output 3.3 V**

Symbol	Parameter	Test Conditions	Min.	Typ.	Max.	Unit
$V_O$	Output voltage 3.3V	$I_O = 5\text{mA to } 1\text{A}$ , $V_I = 4.75 \text{ to } 5.25\text{V}$ $T = 25^\circ\text{C}$	3.234	3.3	3.366	V
$V_O$	Output voltage 3.3V	$I_O = 5\text{mA to } 1\text{A}$ , $V_I = 4.75 \text{ to } 5.25\text{V}$	3.2	3.3	3.4	V
$\Delta V_O$	Line regulation	$V_I = 4.75 \text{ to } 5.25\text{V}$ , $I_O = 5\text{mA to } 1\text{A}$			15	mV
$\Delta V_O$	Load regulation	$V_I = 4.75\text{V}$ , $I_O = 10\text{mA to } 1\text{A}$			12	mV
$V_D$	Dropout voltage $\Delta V_O = -1\%$	$I_O = 1\text{A}$			1.3	V
$I_S$	Current limit	$V_I = 5.5\text{V}$	1			A
$I_{O\text{MIN}}$	Min. output current for regulation				0	mA
$e_N$	RMS output noise <sup>(1) (5)</sup>	$T = 25^\circ\text{C}$		0.003		%
SVR	Supply voltage rejection <sup>(2)(5)</sup>	$V_I = 5\text{V}$	60			dB
$\Delta V_O/\Delta I_O$	Transient response change of $V_O$ with step load change <sup>(3)(5)</sup>	$V_I = 5\text{V}$ , $I_O = 1\text{mA to } 1\text{A}$ , $t_r \geq 1\mu\text{s}$			$10^{(4)}$	%
		$V_I = 5\text{V}$ , $I_O = 1\text{A to } 1\text{mA}$ , $t_r \geq 1\mu\text{s}$			$10^{(4)}$	
$\Delta V_{O1}/\Delta V_I$	Transient response change of $V_{O\text{UT}1}$ with application of $V_I$ <sup>(3)(5)</sup>	0 to 5V step input, $I_O = 1\text{mA to } 1\text{A}$ , $t_r \geq 1\mu\text{s}$			$10^{(4)}$	%
$\Delta V_O/\Delta I_O$	Transient response short circuit removal response <sup>(3)(5)</sup>	$V_I = 5\text{V}$ , $I_O = \text{short to } I_O = 10\text{mA}$			$20^{(4)}$	%
$T_R$	Thermal regulation <sup>(5)</sup>	$I_O = 1\text{A}$ , $t_{\text{PULSE}} = 30\text{ms}$		0.1		%/W
S	Temperature stability <sup>(5)</sup>			0.5		%
S	Long-term stability <sup>(5)</sup> (1000hrs)	$T_J = 125^\circ\text{C}$		0.3		%

1. Bandwidth of 10 Hz to 10 kHz.
2. 120 Hz input ripple.
3.  $C_I = 20 \text{ } \mu\text{F}$ ,  $C_{O1}$  and  $C_{O2} = 10 \text{ } \mu\text{F}$ .  $C_I$ ,  $C_{O1}$  and  $C_{O2}$  are all X7R ceramic capacitors.
4. % undershoot or overshoot of  $V_O$
5. Guaranteed by design, not tested in production.

$I_O = 10 \text{ mA to } 1 \text{ A}$ ,  $T_J = 0 \text{ to } 125 \text{ }^\circ\text{C}$ ,  $V_I = 4.5 \text{ V to } 7 \text{ V}$ ,  $C_I = 4.7 \text{ } \mu\text{F}$ ,  $C_{O1} = C_{O2} = 4.7 \text{ } \mu\text{F}$ , unless otherwise specified.

**Table 13. Electrical characteristics of adjustable output**

Symbol	Parameter	Test conditions	Min.	Typ.	Max.	Unit
$V_O$	Reference voltage	$I_O = 5\text{mA to } 1\text{A}$ , $V_I = 4.75 \text{ to } 5.25\text{V}$ , $T = 25^\circ\text{C}$	1.225	1.25	1.275	V
$V_O$	Reference voltage	$I_O = 5\text{mA to } 1\text{A}$ , $V_I = 4.75 \text{ to } 5.25\text{V}$	1.212	1.25	1.287	V
$\Delta V_{O2}$	Line regulation 2	$V_I = 4.75 \text{ to } 5.25\text{V}$ , $I_O = 5\text{mA to } 1\text{A}$			0.35	%
$\Delta V_{O2}$	Load regulation 2	$V_I = 4.75\text{V}$ , $I_O = 10\text{mA to } 1\text{A}$			0.4	%
$V_D$	Dropout voltage $\Delta V_O = -1\%$	$I_O = 1\text{A}$			1.3	V
$I_S$	Current limit	$V_I = 5.5\text{V}$	1			A
$I_{ADJ}$	Adjustable current (sinking)				1	$\mu\text{A}$
$I_{\Delta ADJ}$	Adjustable current change	$I_O = 10\text{mA to } 1\text{A}$			200	nA
$I_{OMIN}$	Min. output current for regulation				2	mA
$e_N$	RMS output noise <sup>(1) (5)</sup>	$T = 25^\circ\text{C}$		0.003		%
SVR	Supply voltage rejection <sup>(2)(5)</sup>	$V_I = 5\text{V}$	60			dB
$\Delta V_{O2}/\Delta I_O$ 2	Transient response change of $V_O$ with step load change <sup>(3)(5)</sup>	$V_I = 5\text{V}$ , $I_O = 1\text{mA to } 1\text{A}$ , $t_r \geq 1\mu\text{s}$			$10^{(4)}$	%
		$V_I = 5\text{V}$ , $I_O = 1\text{A to } 1\text{mA}$ , $t_r \geq 1\mu\text{s}$			$10^{(4)}$	
$\Delta V_{O2}/\Delta V_I$	Transient response change of $V_{OUT1}$ with application of $V_I$ <sup>(3)(5)</sup>	0 to 5V step input, $I_O = 1\text{mA to } 1\text{A}$ , $t_r \geq 1\mu\text{s}$			$10^{(4)}$	%
$\Delta V_{O2}/\Delta I_O$ 2	Transient response short circuit removal response <sup>(3)(5)</sup>	$V_I = 5\text{V}$ , $I_O = \text{short to } I_O = 10\text{mA}$			$20^{(4)}$	%
$T_R$	Thermal regulation <sup>(5)</sup>	$I_O = 1\text{A}$ , $t_{PULSE} = 30\text{ms}$		0.1		%/W
S	Temperature stability <sup>(5)</sup>			0.5		%
S	Long-term stability <sup>(5)</sup> (1000hrs)	$T_J = 125^\circ\text{C}$		0.3		%

1. Bandwidth of 10 Hz to 10 kHz.
2. 120 Hz input ripple.
3.  $C_I = 20 \text{ } \mu\text{F}$ ,  $C_{O1}$  and  $C_{O2} = 10 \text{ } \mu\text{F}$ .  $C_I$ ,  $C_{O1}$  and  $C_{O2}$  are all X7R ceramic capacitors.
4. % undershoot or overshoot of  $V_O$
5. Guaranteed by design, not tested in production.

## 6 Application hints

### 6.1 External capacitors

Like any low-dropout regulator, the ST2L05-3300 requires external capacitors for stability. It is recommended to solder both capacitors as close as possible to the relative pins (1, 4 and 5).

### 6.2 Input capacitor

An input capacitor with a value of at least 2.2  $\mu\text{F}$  is required. The amount of input capacitance can be increased without limit if a good quality tantalum or aluminium capacitor is used. SMD X7R or Y5V ceramic multilayer capacitors may not ensure stability in any condition due to the variability of their frequency and temperature characteristics. The use of this capacitor type is strictly related to the use of the output capacitors. For additional details, please read the [Output capacitor](#) section below. The input capacitor must be located at a distance of not more than 0.5" from the input pin of the device and returned to a clean analog ground.

### 6.3 Output capacitor

The ST2L05-3300 is designed specifically to work with ceramic and tantalum capacitors. Special care must be taken when a ceramic multilayer capacitor is used. Due to their characteristics, this type of capacitor can sometimes have an ESR value lower than the minimum required by the ST2L05-3300, and their relatively large capacitance can vary greatly depending on the ambient temperature. The test results for the stability of the ST2L05-3300 using multilayer ceramic capacitors show that a minimum value of 2.2  $\mu\text{F}$  is needed for both regulators. This value can be increased without limit if the input capacitor value is greater than or equal to 4.7  $\mu\text{F}$ , and up to 10  $\mu\text{F}$  if the input capacitor is less than 4.7  $\mu\text{F}$ . Surface-mountable solid tantalum capacitors offer a good combination of small physical size, capacitance value and ESR in the range needed for the ST2L05-3300. Test results show good stability for both outputs with values of at least 1  $\mu\text{F}$ . The value can be increased without limit for even better performance in areas such as transient response and noise.

#### **Important:**

The output capacitor must maintain an ESR in the stable region over the full operating temperature to assure stability. Moreover, capacitor tolerance and variations due to temperature must be considered to assure that the minimum amount of capacitance is provided at all times. For this reason, when a ceramic multilayer capacitor is used, the better choice for temperature coefficient is the X7R type, which holds the capacitance within  $\pm 15\%$ . The output capacitor should be located not more than 0.5" from the output pins of the device and returned to a clean analog ground.

### 6.4 Adjustable regulator

The ST2L05-3300 has a 1.25 V reference voltage between the output and the adjust pins (pins 4 and 2, respectively). When resistor  $R_1$  is placed between these two terminals, a constant current flows through  $R_1$  and down to  $R_2$  to set the overall ( $V_{O2}$  to GND) output voltage. Minimum load current is 2 mA max in all temperature conditions.

Figure 4. Application circuit

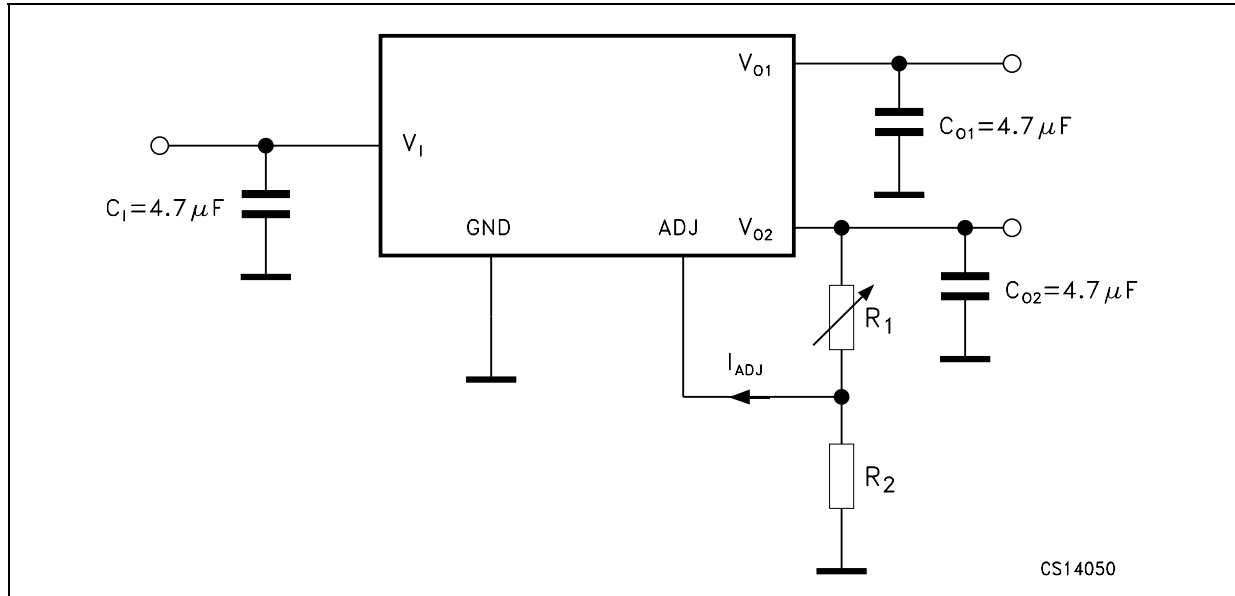

$$V_O = V_{REF} (1 + R_1 / R_2) + I_{ADJ}R_1$$

$I_{ADJ}$  is very small (typically 35  $\mu$ A) and constant: in the  $V_O$  calculation it can be ignored.



# 7 Typical characteristics

Figure 5. Reference voltage vs. temperature

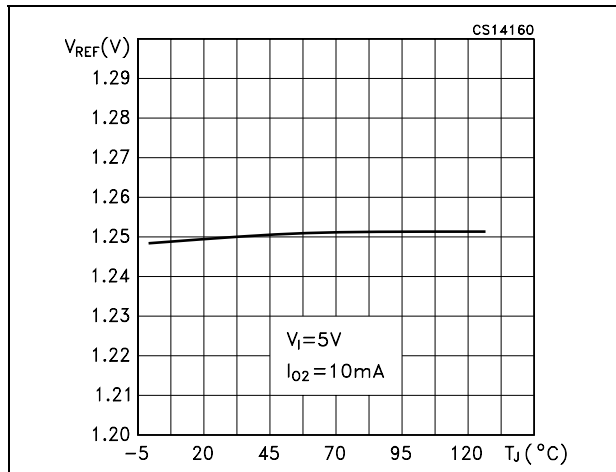

Figure 6. Reference line regulation vs. temperature

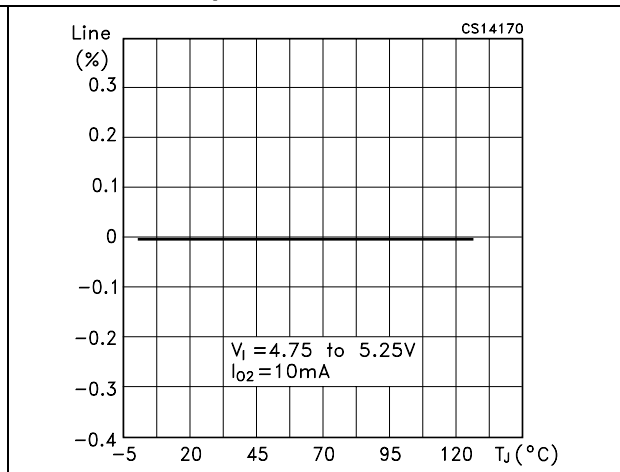

Figure 7. Reference load regulation vs. temperature

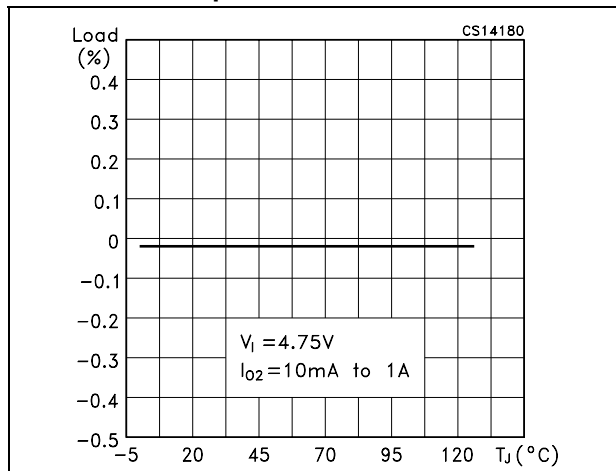
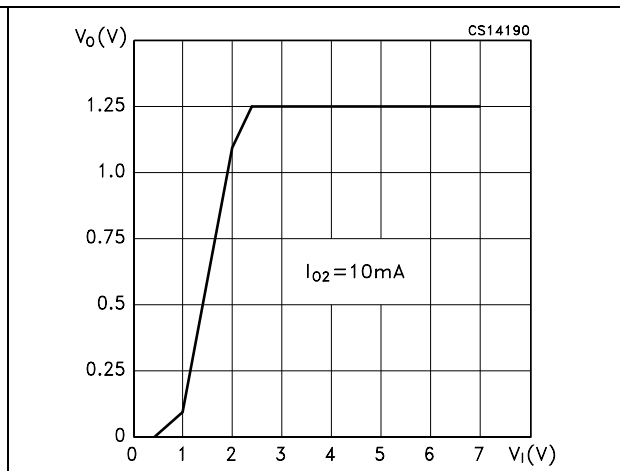
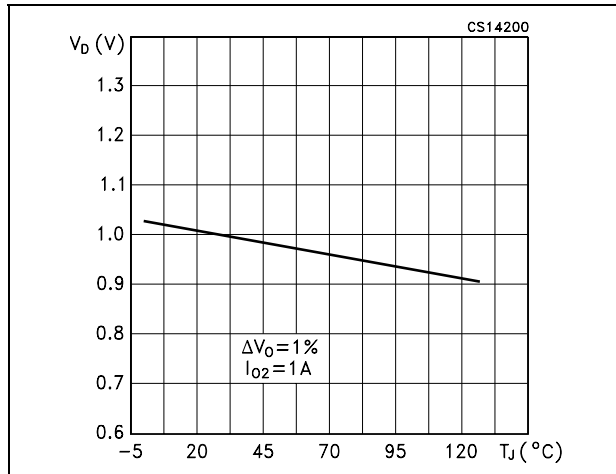

Figure 8. Reference voltage vs. input voltage



**Figure 9. Dropout voltage vs. temperature (adjustable output)**



**Figure 10. Dropout voltage vs. input voltage (adjustable output)**

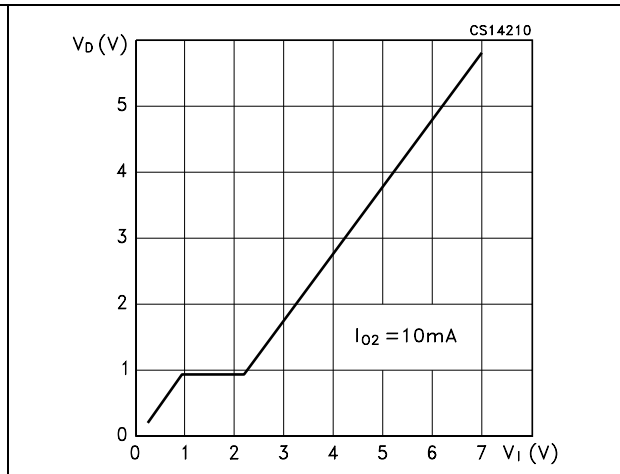

**Figure 11. Minimum load current vs. temperature (adjustable output)**

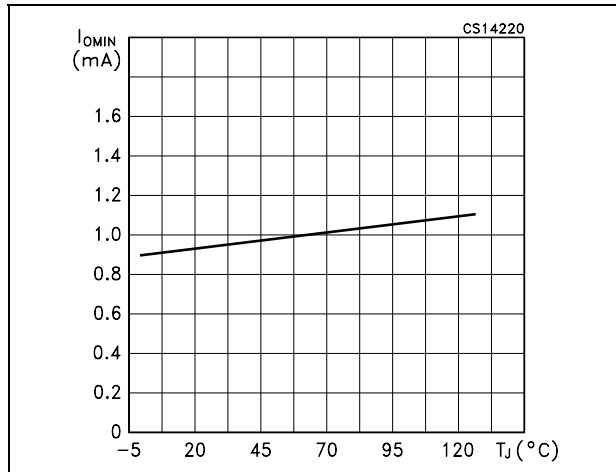

**Figure 12. Adjust pin current vs. temperature (adjustable output)**

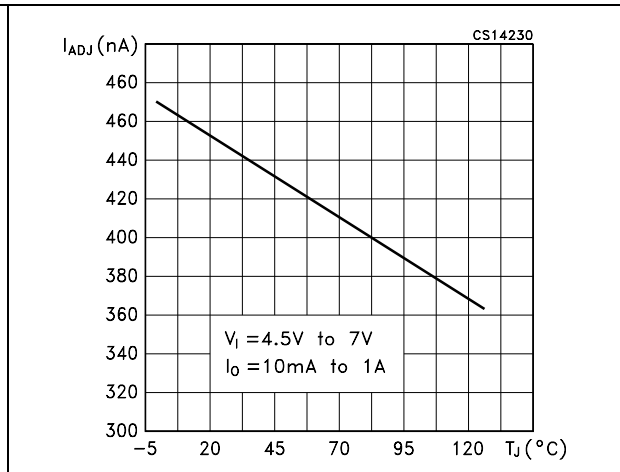

Figure 13. Output voltage vs. temperature

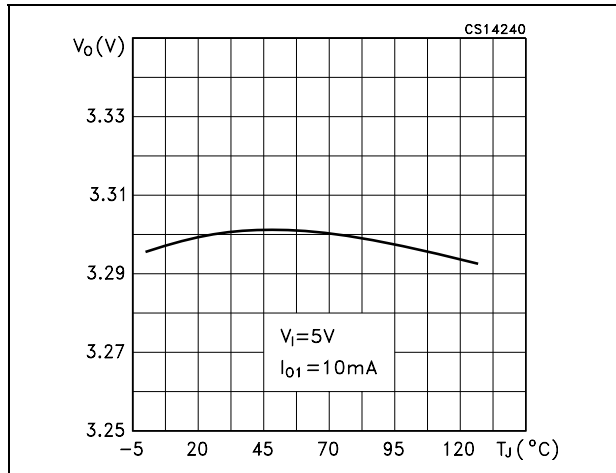

Figure 14. Line regulation vs. temperature

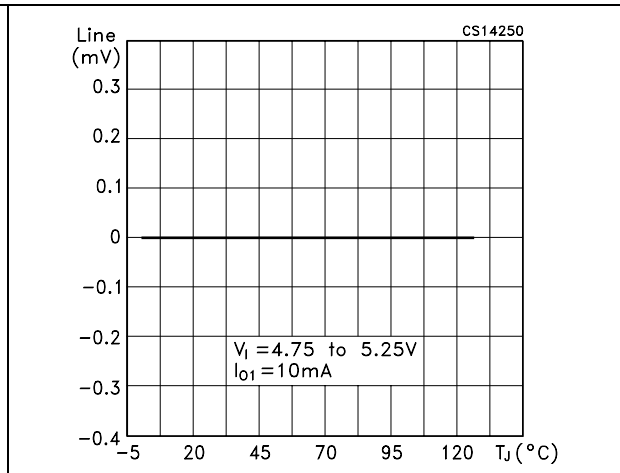

Figure 15. Load regulation vs. temperature

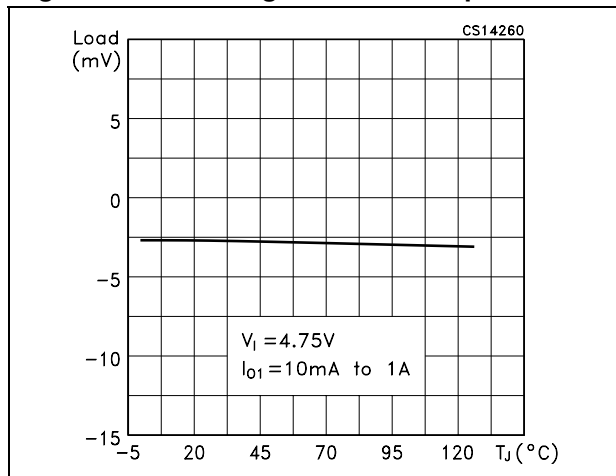

Figure 16. Output voltage vs. input voltage

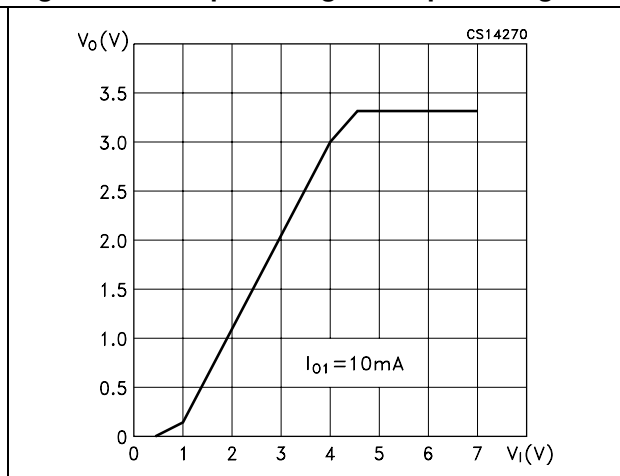

Figure 17. Dropout voltage vs. temperature (fixed output)

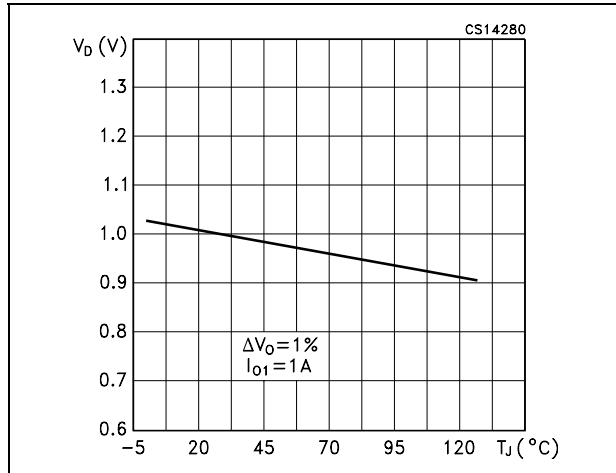

Figure 18. Dropout voltage vs. input voltage

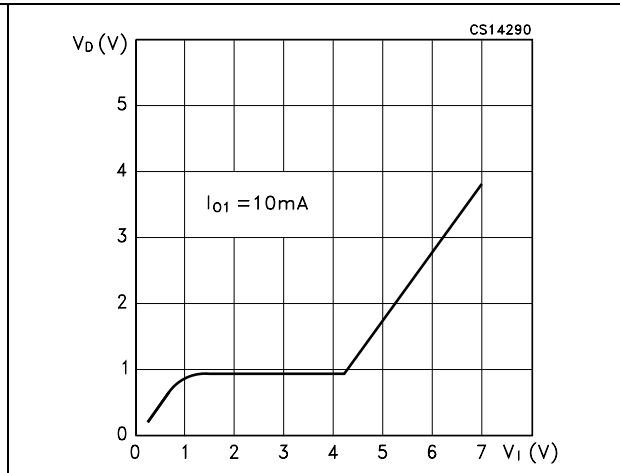

Figure 19. Supply voltage rejection vs. temperature

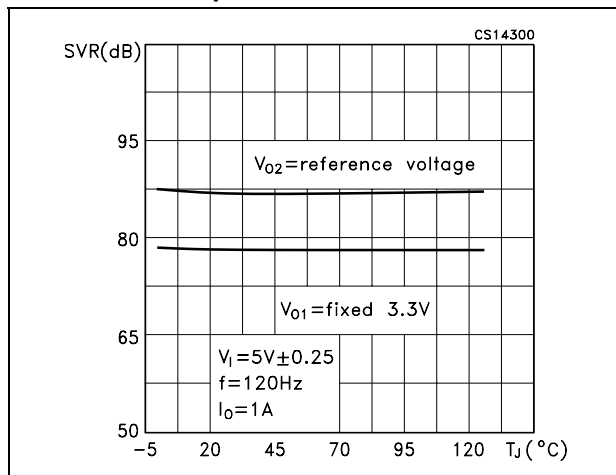

Figure 20. Supply voltage rejection vs. frequency

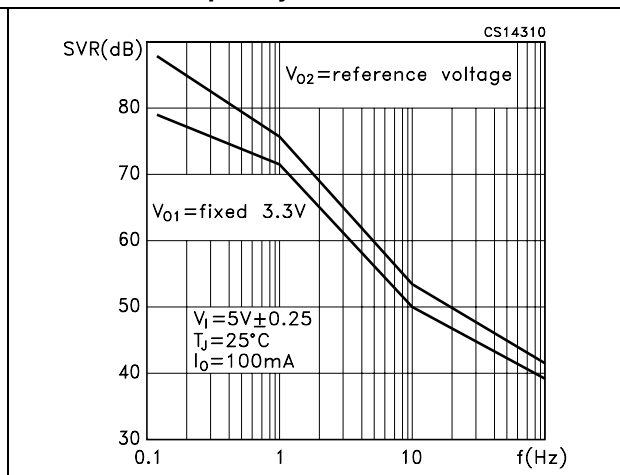

Figure 21. Quiescent current vs. temperature (fixed/adj. version)

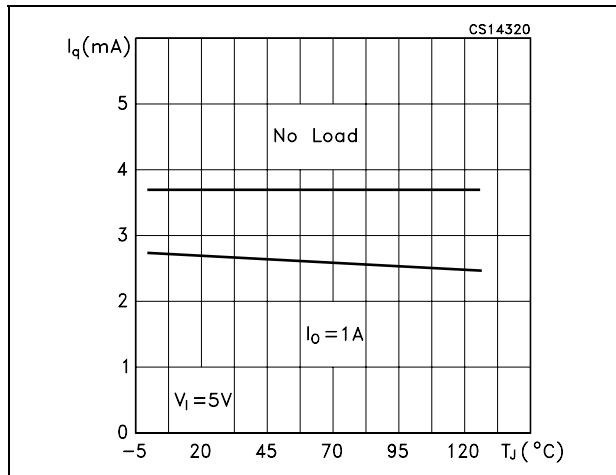

Figure 22. Quiescent current vs. temperature (fixed/fixed version)

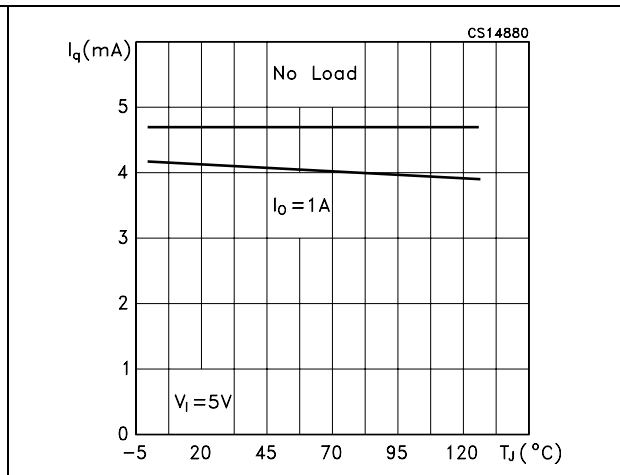

Figure 23. Short-circuit removal response

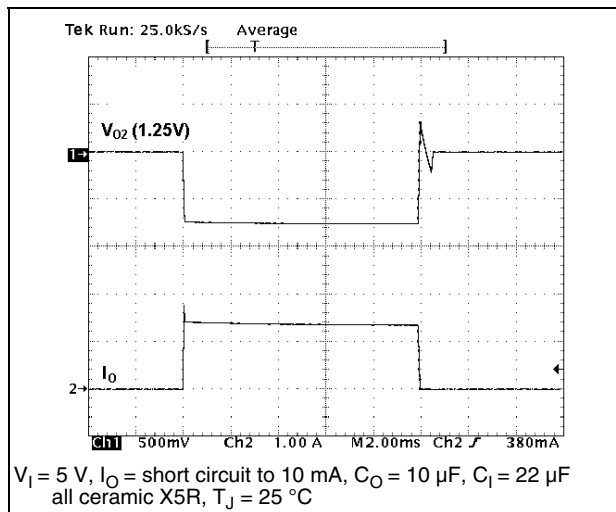

Figure 24. Change of V<sub>O</sub> with step load change

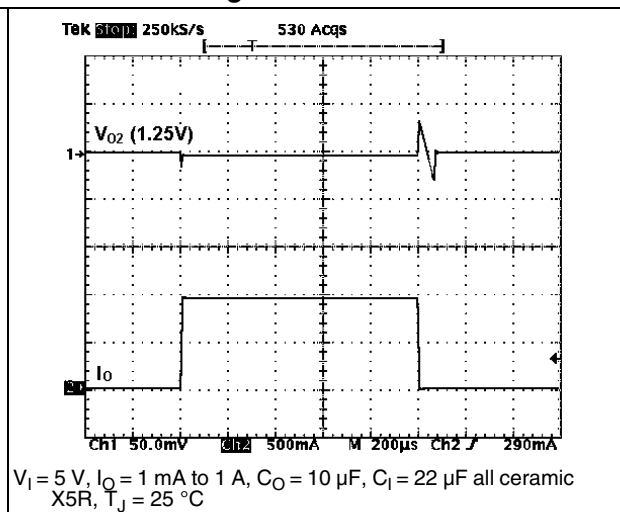

Figure 25. Change of  $V_O$  with step load change

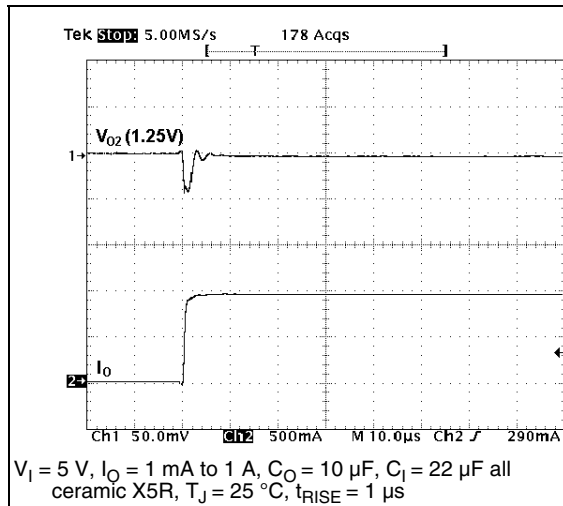

Figure 26. Change of  $V_O$  with step load change

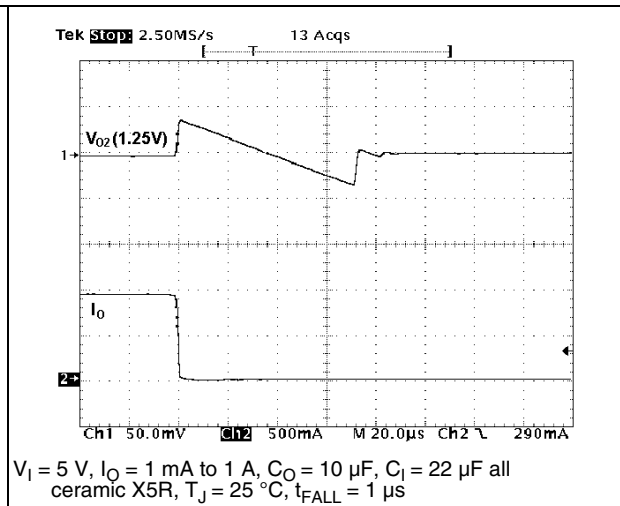

Figure 27. Short-circuit removal response

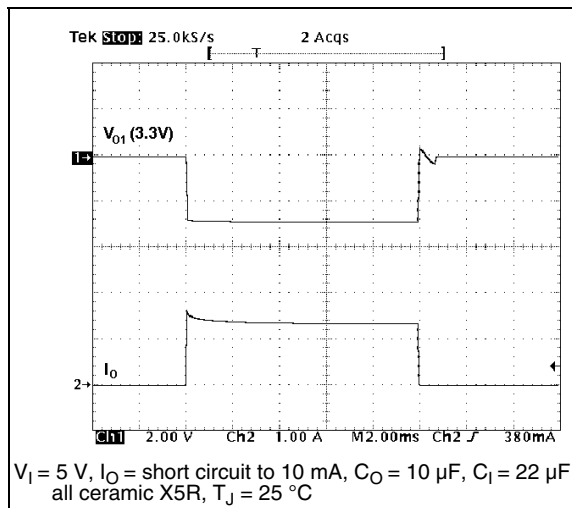

Figure 28. Change of  $V_O$  with step load change

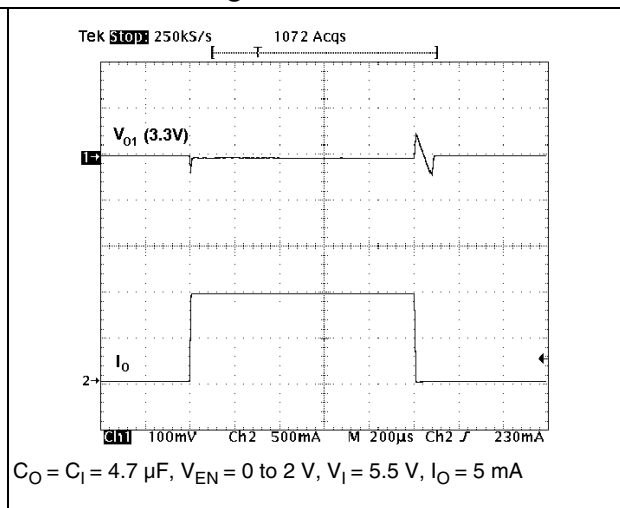

Figure 29. Change of  $V_O$  with step load change Figure 30. Change of  $V_O$  with step load change

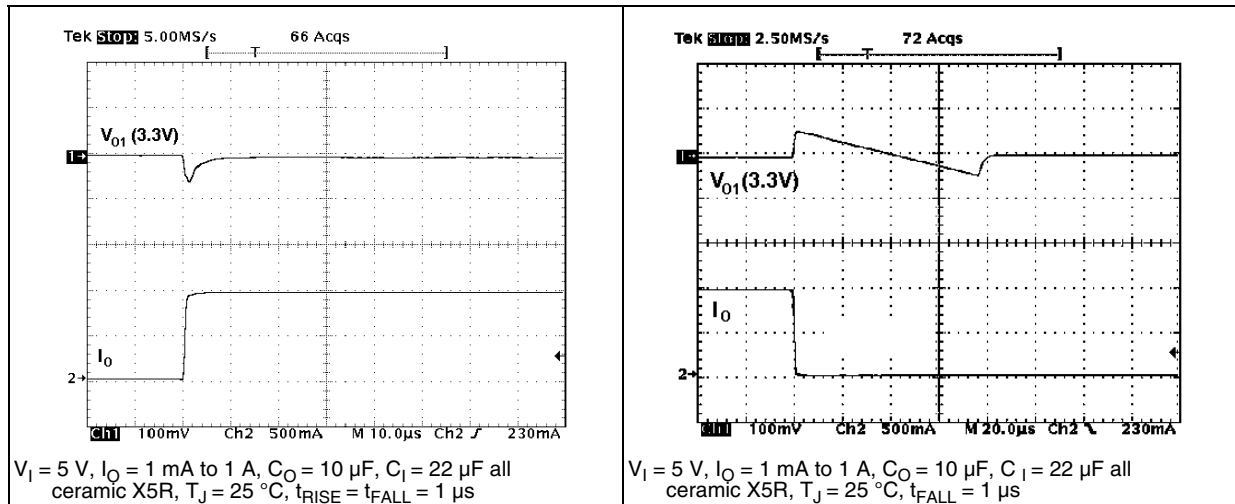

Figure 31. Start-up transient

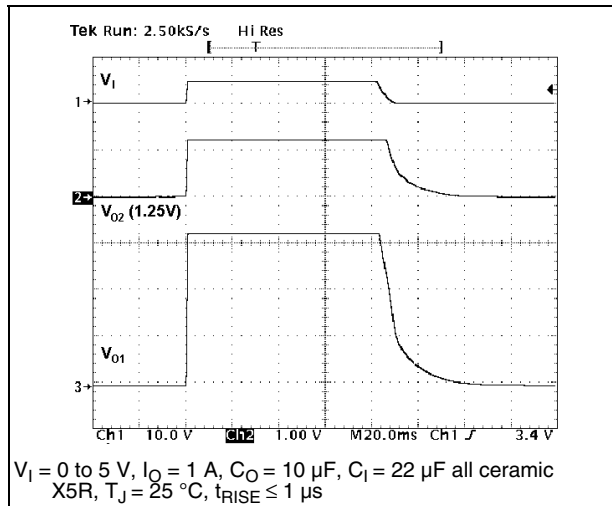
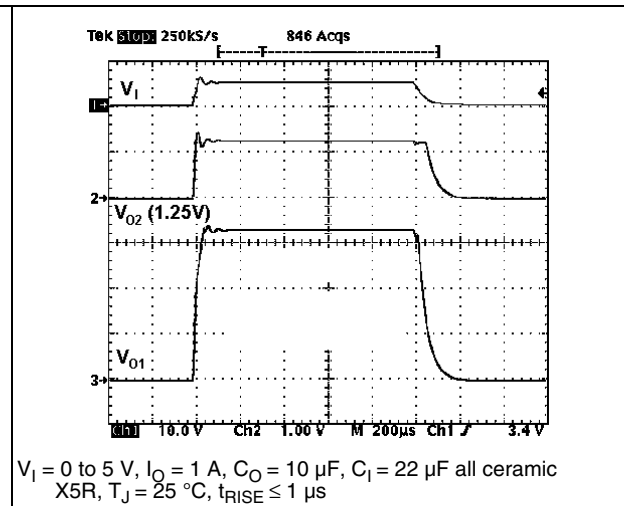

Figure 32. Start-up transient



## 8 Package mechanical data

In order to meet environmental requirements, ST offers these devices in different grades of ECOPACK® packages, depending on their level of environmental compliance. ECOPACK® specifications, grade definitions and product status are available at: [www.st.com](http://www.st.com). ECOPACK is an ST trademark.



**DFN8 (5x6 mm) mechanical data**

Dim.	mm.			inch.		
	Min.	Typ.	Max.	Min.	Typ.	Max.
A	0.80	0.90	1.00	0.032	0.035	0.039
A1		0.02	0.05		0.001	0.002
A3		0.20			0.008	
b	0.35	0.40	0.47	0.014	0.016	0.018
D		5.00			0.197	
D2	4.15	4.2	4.25	0.163	0.165	0.167
E		6.00			0.236	
E2	3.55	3.6	3.65	0.140	0.142	0.144
e		1.27			0.049	
F		1.99			0.078	
G		2.20			0.086	
H		0.40			0.015	
I		0.219			0.0086	
L	0.70		0.90	0.028		0.035

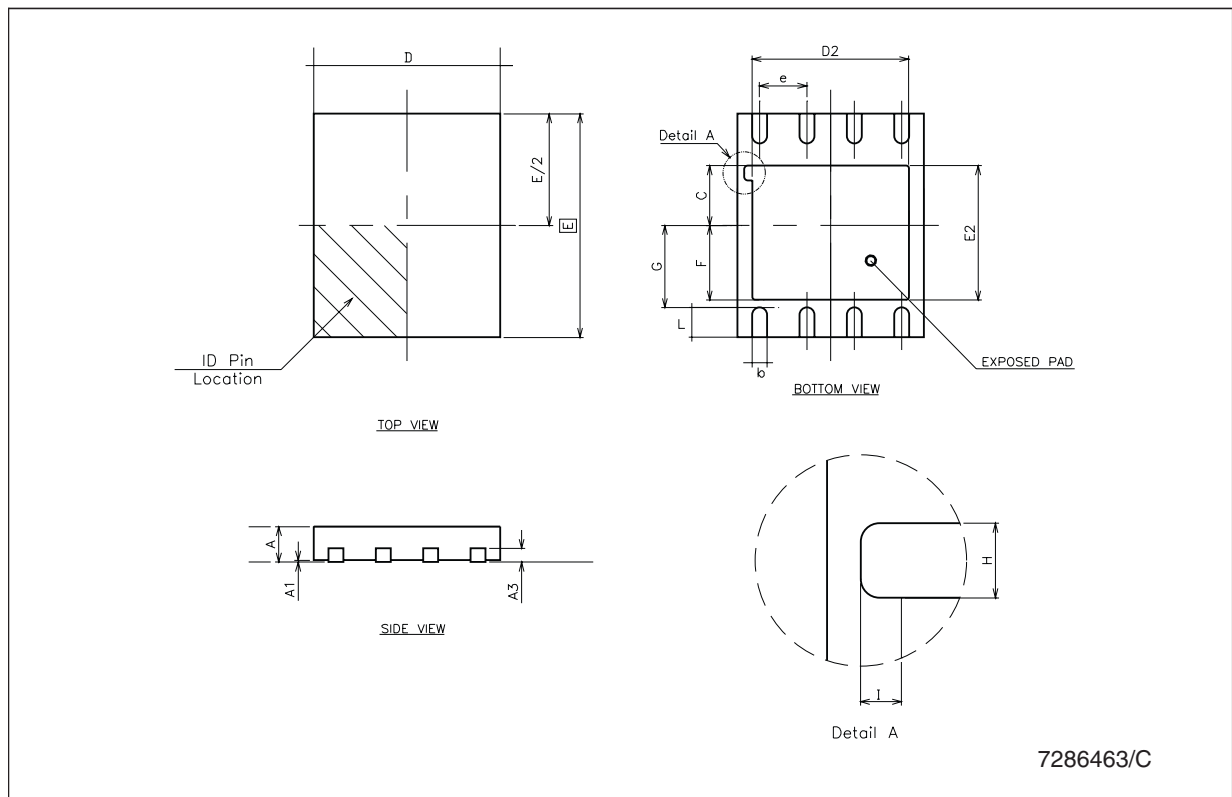

**Tape and reel QFNxx/DFNxx (5x6 mm) mechanical data**

Dim.	mm.			inch.		
	Min.	Typ.	Max.	Min.	Typ.	Max.
A			330			12.992
C	12.8		13.2	0.504		0.520
D	20.2			0.795		
N	99		101	3.898		3.976
T			14.4			0.567
Ao		5.30			0.209	
Bo		6.30			0.248	
Ko		1.20			0.047	
Po		4			0.157	
P		8			0.315	

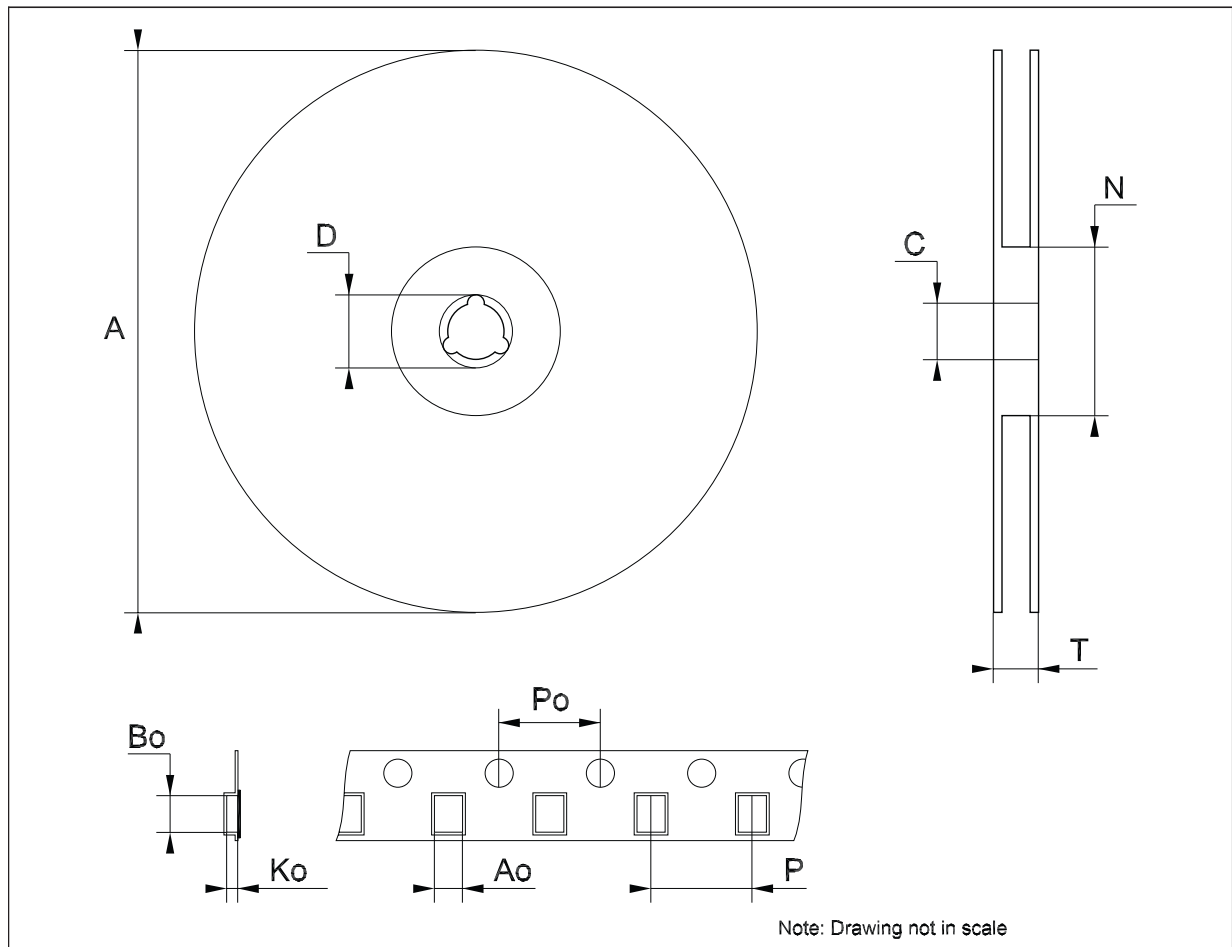

## 9 Different output voltage versions of the ST2L05-3300 available on request

Table 14. Options available on request

V <sub>O1</sub>	V <sub>O2</sub>	Order codes	Shipment
1.8 V	ADJ	ST2L05R1800PS	Tape and reel
2.5 V	ADJ	ST2L05R2500PS	Tape and reel
2.8 V	ADJ	ST2L05R2800PS	Tape and reel
3.0 V	1.5 V	ST2L05R3015PS	Tape and reel
3.0 V	ADJ	ST2L05R3000PS	Tape and reel

## 10 Revision history

**Table 15. Document revision history**

<b>Date</b>	<b>Revision</b>	<b>Changes</b>
18-Nov-2004	4	Removed PPAK version.
24-Nov-2004	5	Added new mechanical data.
06-Dec-2004	6	Modified mechanical data.
13-Feb-2009	7	Removed SPAK5-L version.

**Please Read Carefully:**

Information in this document is provided solely in connection with ST products. STMicroelectronics NV and its subsidiaries ("ST") reserve the right to make changes, corrections, modifications or improvements, to this document, and the products and services described herein at any time, without notice.

All ST products are sold pursuant to ST's terms and conditions of sale.

Purchasers are solely responsible for the choice, selection and use of the ST products and services described herein, and ST assumes no liability whatsoever relating to the choice, selection or use of the ST products and services described herein.

No license, express or implied, by estoppel or otherwise, to any intellectual property rights is granted under this document. If any part of this document refers to any third party products or services it shall not be deemed a license grant by ST for the use of such third party products or services, or any intellectual property contained therein or considered as a warranty covering the use in any manner whatsoever of such third party products or services or any intellectual property contained therein.

**UNLESS OTHERWISE SET FORTH IN ST'S TERMS AND CONDITIONS OF SALE ST DISCLAIMS ANY EXPRESS OR IMPLIED WARRANTY WITH RESPECT TO THE USE AND/OR SALE OF ST PRODUCTS INCLUDING WITHOUT LIMITATION IMPLIED WARRANTIES OF MERCHANTABILITY, FITNESS FOR A PARTICULAR PURPOSE (AND THEIR EQUIVALENTS UNDER THE LAWS OF ANY JURISDICTION), OR INFRINGEMENT OF ANY PATENT, COPYRIGHT OR OTHER INTELLECTUAL PROPERTY RIGHT.**

**UNLESS EXPRESSLY APPROVED IN WRITING BY AN AUTHORIZED ST REPRESENTATIVE, ST PRODUCTS ARE NOT RECOMMENDED, AUTHORIZED OR WARRANTED FOR USE IN MILITARY, AIR CRAFT, SPACE, LIFE SAVING, OR LIFE SUSTAINING APPLICATIONS, NOR IN PRODUCTS OR SYSTEMS WHERE FAILURE OR MALFUNCTION MAY RESULT IN PERSONAL INJURY, DEATH, OR SEVERE PROPERTY OR ENVIRONMENTAL DAMAGE. ST PRODUCTS WHICH ARE NOT SPECIFIED AS "AUTOMOTIVE GRADE" MAY ONLY BE USED IN AUTOMOTIVE APPLICATIONS AT USER'S OWN RISK.**

Resale of ST products with provisions different from the statements and/or technical features set forth in this document shall immediately void any warranty granted by ST for the ST product or service described herein and shall not create or extend in any manner whatsoever, any liability of ST.

ST and the ST logo are trademarks or registered trademarks of ST in various countries.

Information in this document supersedes and replaces all information previously supplied.

The ST logo is a registered trademark of STMicroelectronics. All other names are the property of their respective owners.

© 2009 STMicroelectronics - All rights reserved

STMicroelectronics group of companies

Australia - Belgium - Brazil - Canada - China - Czech Republic - Finland - France - Germany - Hong Kong - India - Israel - Italy - Japan - Malaysia - Malta - Morocco - Singapore - Spain - Sweden - Switzerland - United Kingdom - United States of America

[www.st.com](http://www.st.com)

