



# STC04IE170HV

Monolithic emitter switched bipolar transistor  
 ESBT® 1700 V - 4 A - 0.17 Ω

## Features

$V_{CS(ON)}$	$I_C$	$R_{CS(ON)}$
0.7 V	4 A	0.17 Ω

- High voltage / high current cascode configuration
- Low equivalent ON resistance
- Very fast-switch: up to 150 kHz
- Squared RBSOA: up to 1700 V
- Very low  $C_{ISS}$  driven by  $R_G = 47 \Omega$
- Very low turn-off cross over time

## Application

- Aux SMPS for three-phase mains

## Description

The STC04IE170HV is manufactured in monolithic ESBT technology, aimed at providing the best performance in high frequency / high voltage applications. It is designed for use in gate driven based topologies.

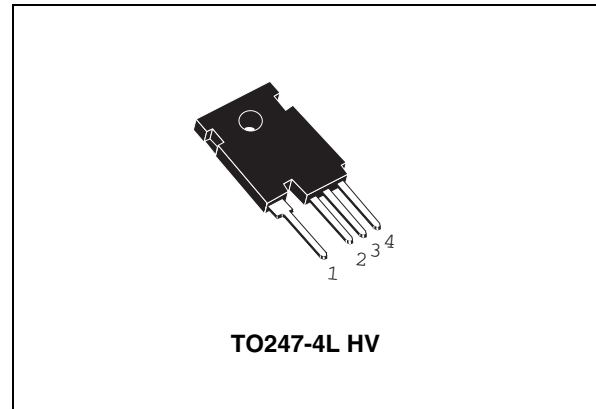

**Figure 1. Internal schematic diagrams**

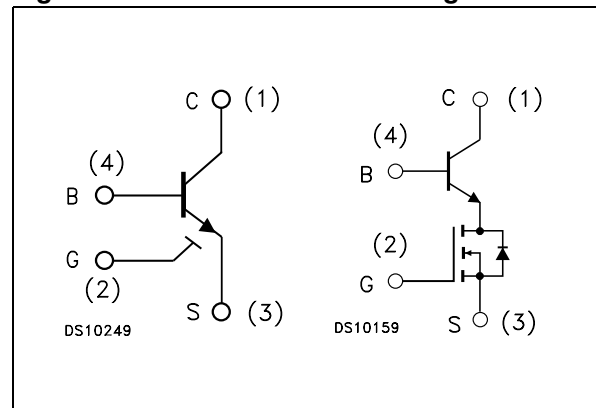

**Table 1. Device summary**

Order code	Marking	Package	Packing
STC04IE170HV	C04IE170HV	TO247-4L HV	Tube

# 1 Electrical ratings

**Table 2. Absolute maximum ratings**

Symbol	Parameter	Value	Unit
$V_{CS(SS)}$	Collector-source voltage ( $V_{BS} = V_{GS} = 0$ )	1700	V
$V_{BS(OS)}$	Base-source voltage ( $I_C = 0, V_{GS} = 0$ )	30	V
$V_{SB(OS)}$	Source-base voltage ( $I_C = 0, V_{GS} = 0$ )	17	V
$V_{GS}$	Gate-source voltage	$\pm 17$	V
$I_C$	Collector current	4	A
$I_{CM}$	Collector peak current ( $t_P < 5$ ms)	8	A
$I_B$	Base current	4	A
$I_{BM}$	Base peak current ( $t_P < 1$ ms)	8	A
$P_{tot}$	Total dissipation at $T_C \leq 25$ °C	178	W
$T_{stg}$	Storage temperature	-40 to 150	°C
$T_J$	Max. operating junction temperature	150	°C

**Table 3. Thermal data**

Symbol	Parameter	Value	Unit
$R_{thJC}$	Thermal resistance junction-case	0.7	°C/W

## 2 Electrical characteristics

( $T_{\text{case}} = 25\text{ }^{\circ}\text{C}$  unless otherwise specified)

**Table 4. Electrical characteristics**

Symbol	Parameter	Test conditions	Min.	Typ.	Max.	Unit
$I_{\text{CS(SS)}}$	Collector cut-off current ( $V_{\text{BS}} = V_{\text{GS}} = 0$ )	$V_{\text{CS}} = 1700\text{ V}$			100	$\mu\text{A}$
$I_{\text{BS(OS)}}$	Base cut-off current ( $I_{\text{C}} = 0, V_{\text{GS}} = 0$ )	$V_{\text{BS}} = 30\text{ V}$			10	$\mu\text{A}$
$I_{\text{SB(OS)}}$	Source cut-off current ( $I_{\text{C}} = 0, V_{\text{GS}} = 0$ )	$V_{\text{SB}} = 17\text{ V}$			100	$\mu\text{A}$
$I_{\text{GS(OS)}}$	Gate-source leakage current ( $V_{\text{BS}} = 0$ )	$V_{\text{GS}} = \pm 17\text{ V}$			100	nA
$V_{\text{CS(ON)}}$	Collector-source ON voltage	$V_{\text{GS}} = 10\text{ V } I_{\text{C}} = 4\text{ A } I_{\text{B}} = 0.8\text{ A}$ $V_{\text{GS}} = 10\text{ V } I_{\text{C}} = 1.5\text{ A } I_{\text{B}} = 0.15\text{ A}$		0.7 0.6	1.5 1.4	V V
$h_{\text{FE}}^{(1)}$	DC current gain	$V_{\text{CS}} = 1\text{ V } V_{\text{GS}} = 10\text{ V } I_{\text{C}} = 4\text{ A}$ $V_{\text{CS}} = 1\text{ V } V_{\text{GS}} = 10\text{ V } I_{\text{C}} = 1.5\text{ A}$	4 7	5.5 11		
$V_{\text{BS(ON)}}$	Base-source ON voltage	$V_{\text{GS}} = 10\text{ V } I_{\text{C}} = 4\text{ A } I_{\text{B}} = 0.8\text{ A}$ $V_{\text{GS}} = 10\text{ V } I_{\text{C}} = 1.5\text{ A } I_{\text{B}} = 0.15\text{ A}$		1.3 0.9	1.5 1.1	V V
$V_{\text{GS(th)}}$	Gate threshold voltage	$V_{\text{BS}} = V_{\text{GS}} I_{\text{B}} = 250\text{ }\mu\text{A}$	2	3	4	V
$C_{\text{iss}}$	Input capacitance ( $V_{\text{GS}} = V_{\text{CB}} = 0$ )	$V_{\text{CS}} = 25\text{ V } f = 1\text{ MHz}$		510		pF
$Q_{\text{GS(tot)}}$	Gate-source charge ( $V_{\text{CB}} = 0$ )	$V_{\text{GS}} = 10\text{ V}$		3.9		nC
$t_{\text{s}}$ $t_{\text{f}}$	Inductive load Storage time Fall time	$V_{\text{GS}} = 10\text{ V } R_{\text{G}} = 47\text{ }\Omega$ $V_{\text{Clamp}} = 1360\text{ V } t_{\text{p}} = 4\text{ }\mu\text{s}$ $I_{\text{C}} = 2\text{ A } I_{\text{B}} = 0.4\text{ A}$		770 10		ns ns
$t_{\text{s}}$ $t_{\text{f}}$	Inductive load Storage time Fall time	$V_{\text{GS}} = 10\text{ V } R_{\text{G}} = 47\text{ }\Omega$ $V_{\text{Clamp}} = 1360\text{ V } t_{\text{p}} = 4\text{ }\mu\text{s}$ $I_{\text{C}} = 2\text{ A } I_{\text{B}} = 0.2\text{ A}$		410 10		ns ns
$V_{\text{CS(dyn)}}$	Collector-source dynamic voltage ( $0.5\text{ }\mu\text{s}$ )	$V_{\text{CC}} = V_{\text{Clamp}} = 400\text{ V}$ $V_{\text{GS}} = 10\text{ V } I_{\text{C}} = 1.5\text{ A}$ $I_{\text{B}} = 0.3\text{ A } t_{\text{peak}} = 500\text{ ns}$ $R_{\text{G}} = 47\text{ }\Omega I_{\text{Bpeak}} = 3\text{ A } (2I_{\text{C}})$		5.36		V
$V_{\text{CS(dyn)}}$	Collector-source dynamic voltage ( $1\text{ }\mu\text{s}$ )	$V_{\text{CC}} = V_{\text{Clamp}} = 400\text{ V}$ $V_{\text{GS}} = 10\text{ V } I_{\text{C}} = 1.5\text{ A}$ $I_{\text{B}} = 0.3\text{ A } t_{\text{peak}} = 500\text{ ns}$ $R_{\text{G}} = 47\text{ }\Omega I_{\text{Bpeak}} = 3\text{ A } (2I_{\text{C}})$		4.32		V
$V_{\text{CSW}}$	Maximum collector- source voltage at turn- off without snubber	$R_{\text{G}} = 47\text{ }\Omega h_{\text{FE}} = 5 I_{\text{C}} = 4\text{ A}$	1700			V

1. Pulsed duration =  $300\text{ }\mu\text{s}$ , duty cycle  $\leq 1.5\%$ .

## 2.1 Electrical characteristics (curves)

Figure 2. Output characteristics

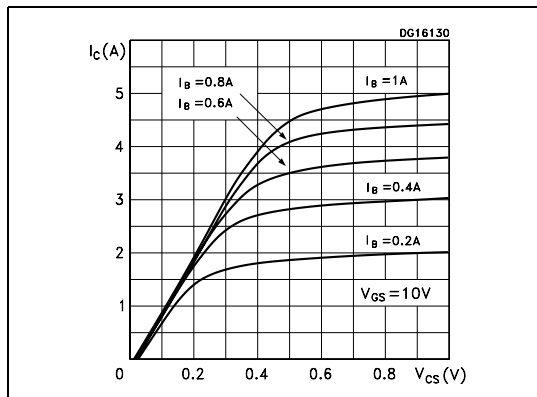

Figure 3. Collector-source dynamic voltage

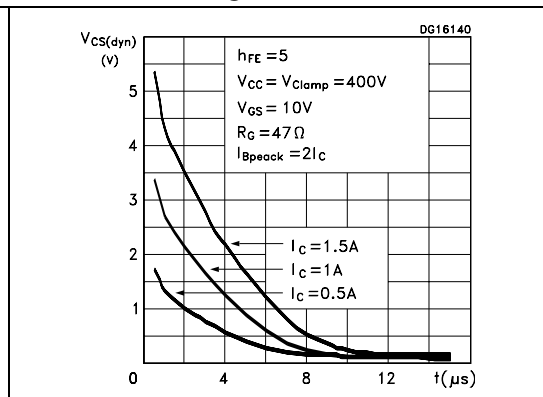

Figure 4. DC current gain

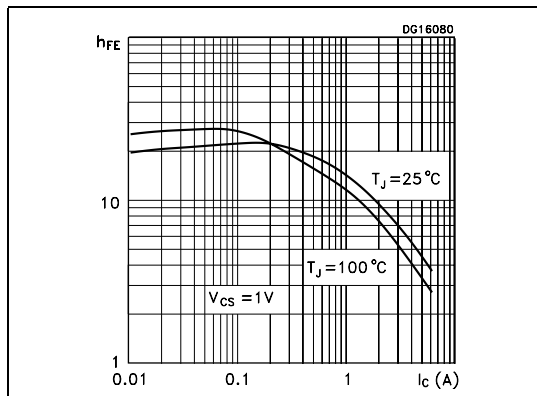

Figure 5. Gate threshold voltage vs. temperature

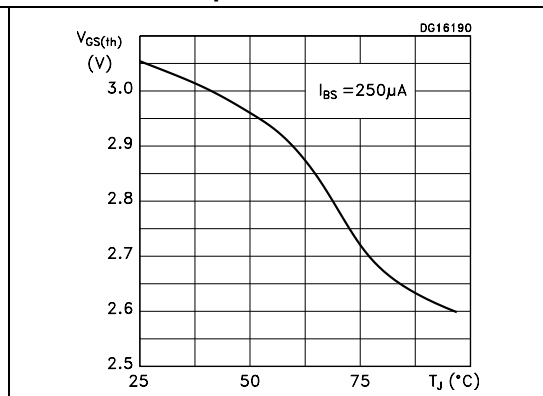

Figure 6. Collector-source ON voltage ( $h_{FE} = 5$ )

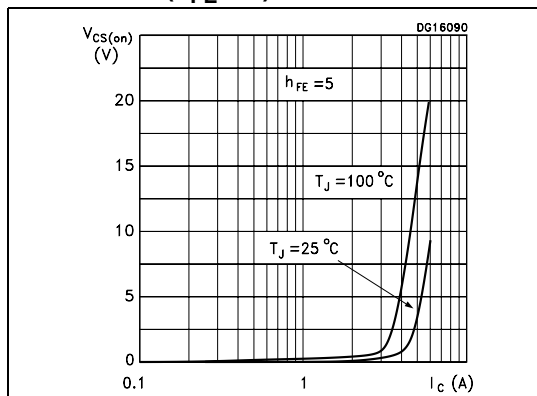
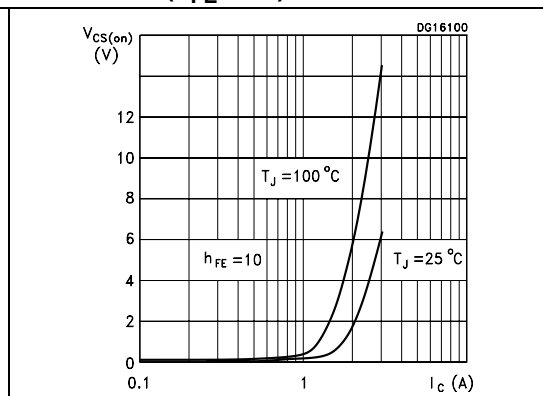
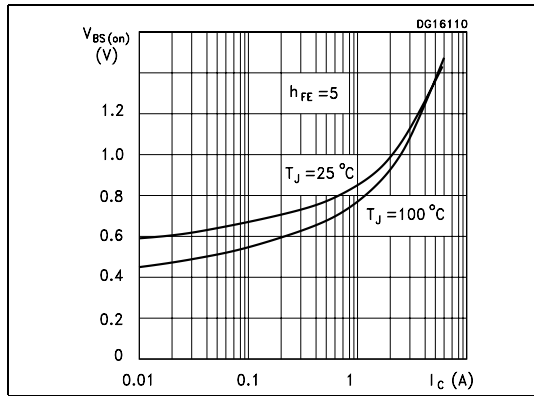

Figure 7. Collector-source ON voltage ( $h_{FE} = 10$ )



**Figure 8. Base-source ON voltage ( $h_{FE} = 5$ )**



**Figure 9. Base-source ON voltage ( $h_{FE} = 10$ )**

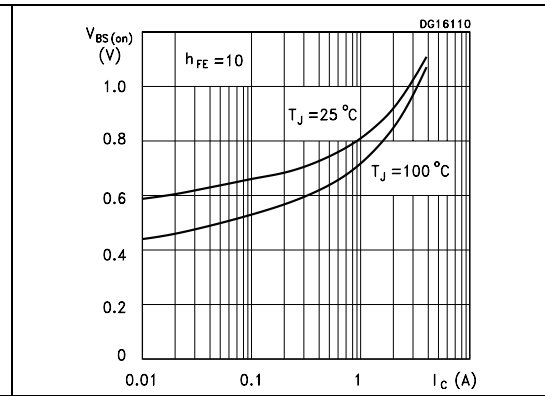

**Figure 10. Inductive load switching time ( $h_{FE} = 5$ )**

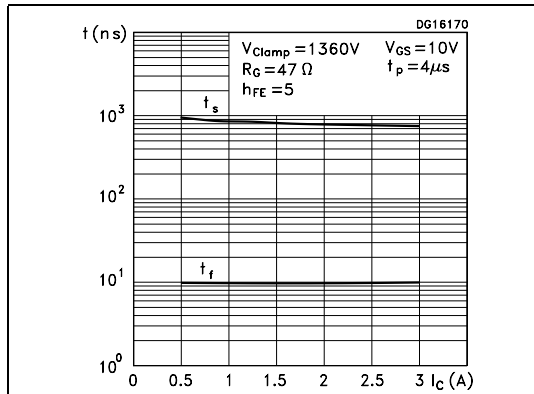

**Figure 11. Inductive load switching time ( $h_{FE} = 10$ )**

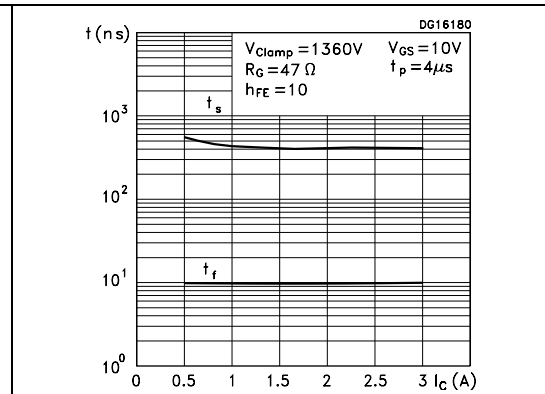

**Figure 12. Reverse biased safe operating area**

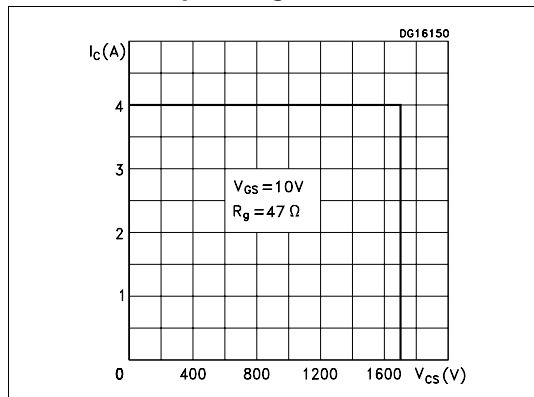

### 3 Package mechanical data

In order to meet environmental requirements, ST offers these devices in different grades of ECOPACK® packages, depending on their level of environmental compliance. ECOPACK® specifications, grade definitions and product status are available at: [www.st.com](http://www.st.com). ECOPACK® is an ST trademark.

**TO247-4L HV mechanical data**

DIM.	mm.		
	MIN.	TYP	MAX.
A	4.85		5.15
A1	2.20	2.50	2.60
A2		1.27	
b	0.95	1.10	1.30
b1	1.10		1.50
b2	2.50		2.90
c	0.40		0.80
D	23.85	24	24.15
D1		21.50	
E	15.45	15.60	15.75
e		2.54	
e1		5.08	
L	10.20		10.80
L1	2.20	2.50	2.80
L2		18.50	
L3		3	
øP	3.55		3.65
S		5.50	

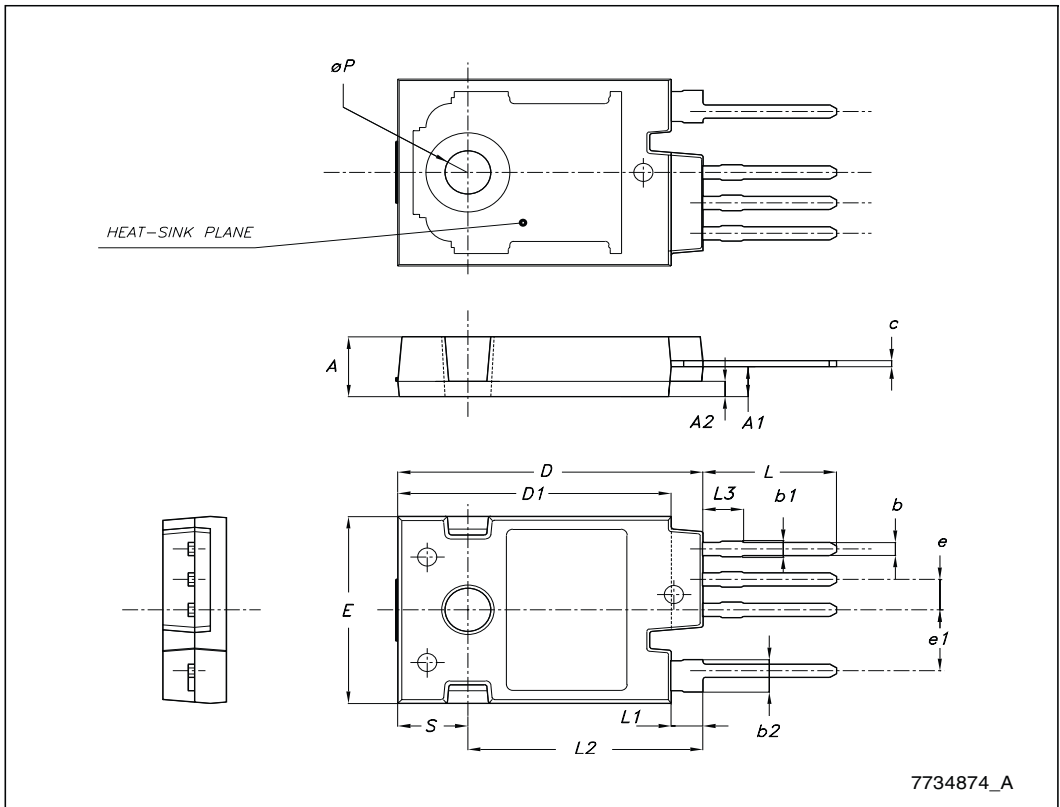

## 4 Revision history

**Table 5. Document revision history**

Date	Revision	Changes
11-Sep-2006	1	First release.
21-Nov-2006	2	Improved application target.
16-Jun-2009	3	Updated <a href="#">Figure 2 on page 4</a> and mechanical data.



**Please Read Carefully:**

Information in this document is provided solely in connection with ST products. STMicroelectronics NV and its subsidiaries ("ST") reserve the right to make changes, corrections, modifications or improvements, to this document, and the products and services described herein at any time, without notice.

All ST products are sold pursuant to ST's terms and conditions of sale.

Purchasers are solely responsible for the choice, selection and use of the ST products and services described herein, and ST assumes no liability whatsoever relating to the choice, selection or use of the ST products and services described herein.

No license, express or implied, by estoppel or otherwise, to any intellectual property rights is granted under this document. If any part of this document refers to any third party products or services it shall not be deemed a license grant by ST for the use of such third party products or services, or any intellectual property contained therein or considered as a warranty covering the use in any manner whatsoever of such third party products or services or any intellectual property contained therein.

**UNLESS OTHERWISE SET FORTH IN ST'S TERMS AND CONDITIONS OF SALE ST DISCLAIMS ANY EXPRESS OR IMPLIED WARRANTY WITH RESPECT TO THE USE AND/OR SALE OF ST PRODUCTS INCLUDING WITHOUT LIMITATION IMPLIED WARRANTIES OF MERCHANTABILITY, FITNESS FOR A PARTICULAR PURPOSE (AND THEIR EQUIVALENTS UNDER THE LAWS OF ANY JURISDICTION), OR INFRINGEMENT OF ANY PATENT, COPYRIGHT OR OTHER INTELLECTUAL PROPERTY RIGHT.**

**UNLESS EXPRESSLY APPROVED IN WRITING BY AN AUTHORIZED ST REPRESENTATIVE, ST PRODUCTS ARE NOT RECOMMENDED, AUTHORIZED OR WARRANTED FOR USE IN MILITARY, AIR CRAFT, SPACE, LIFE SAVING, OR LIFE SUSTAINING APPLICATIONS, NOR IN PRODUCTS OR SYSTEMS WHERE FAILURE OR MALFUNCTION MAY RESULT IN PERSONAL INJURY, DEATH, OR SEVERE PROPERTY OR ENVIRONMENTAL DAMAGE. ST PRODUCTS WHICH ARE NOT SPECIFIED AS "AUTOMOTIVE GRADE" MAY ONLY BE USED IN AUTOMOTIVE APPLICATIONS AT USER'S OWN RISK.**

Resale of ST products with provisions different from the statements and/or technical features set forth in this document shall immediately void any warranty granted by ST for the ST product or service described herein and shall not create or extend in any manner whatsoever, any liability of ST.

ST and the ST logo are trademarks or registered trademarks of ST in various countries.

Information in this document supersedes and replaces all information previously supplied.

The ST logo is a registered trademark of STMicroelectronics. All other names are the property of their respective owners.

© 2009 STMicroelectronics - All rights reserved

STMicroelectronics group of companies

Australia - Belgium - Brazil - Canada - China - Czech Republic - Finland - France - Germany - Hong Kong - India - Israel - Italy - Japan - Malaysia - Malta - Morocco - Philippines - Singapore - Spain - Sweden - Switzerland - United Kingdom - United States of America

[www.st.com](http://www.st.com)

