



12-/14-/16-Bit, Octal-Channel, Ultra-Low Glitch, Voltage Output DIGITAL-TO-ANALOG CONVERTERS with 2.5V, 2ppm/°C Internal Reference

FEATURES

- **Relative Accuracy:**
 - DAC7568 (12-Bit): 0.3 LSB INL
 - DAC8168 (14-Bit): 1 LSB INL
 - DAC8568 (16-Bit): 4 LSB INL
- **Glitch Energy: 0.1nV-s**
- **Internal Reference:**
 - 2.5V Reference Voltage (disabled by default)
 - 0.004% Initial Accuracy (typ)
 - 2ppm/°C Temperature Drift (typ)
 - 5ppm/°C Temperature Drift (max)
 - 20mA Sink/Source Capability
- **Power-On Reset to Zero Scale or Midscale**
- **Ultra-Low Power Operation: 1.25mA at 5V Including Internal Reference Current**
- **Wide Power-Supply Range: +2.7V to +5.5V**
- **Monotonic Over Entire Temperature Range**
- **Low-Power Serial Interface with Schmitt-Triggered Inputs: Up to 50MHz**
- **On-Chip Output Buffer Amplifier with Rail-to-Rail Operation**
- **Temperature Range: –40°C to +125°C**

APPLICATIONS

- **Portable Instrumentation**
- **Closed-Loop Servo-Control/Process Control**
- **Data Acquisition Systems**
- **Programmable Attenuation, Digital Gain, and Offset Adjustment**
- **Programmable Voltage and Current Sources**

DESCRIPTION

The DAC7568, DAC8168, and DAC8568 are low-power, voltage-output, eight-channel, 12-, 14-, and 16-bit digital-to-analog converters (DACs), respectively. These devices include a 2.5V, 2ppm/°C internal reference (disabled by default), giving a full-scale output voltage range of 2.5V or 5V. The internal reference has an initial accuracy of 0.004% and can source up to 20mA at the V_{REFIN}/V_{REFOUT} pin. These devices are monotonic, providing excellent linearity and minimizing undesired code-to-code transient voltages (glitch). They use a versatile 3-wire serial interface that operates at clock rates up to 50MHz. The interface is compatible with standard SPI™, QSPI™, Microwire™, and digital signal processor (DSP) interfaces.

The DAC7568, DAC8168, and DAC8568 incorporate a power-on-reset circuit that ensures the DAC output powers up at either zero scale or midscale until a valid code is written to the device. These devices contain a power-down feature, accessed over the serial interface, that reduces current consumption to typically 0.18μA at 5V. Power consumption (including internal reference) is typically 2.9mW at 3V, reducing to less than 1μW in power-down mode. The low power consumption, internal reference, and small footprint make these devices ideal for portable, battery-operated equipment.

The [DAC7568](#), [DAC8168](#), and [DAC8568](#) are drop-in and function-compatible with each other, and are available in TSSOP-16 and TSSOP-14 packages.

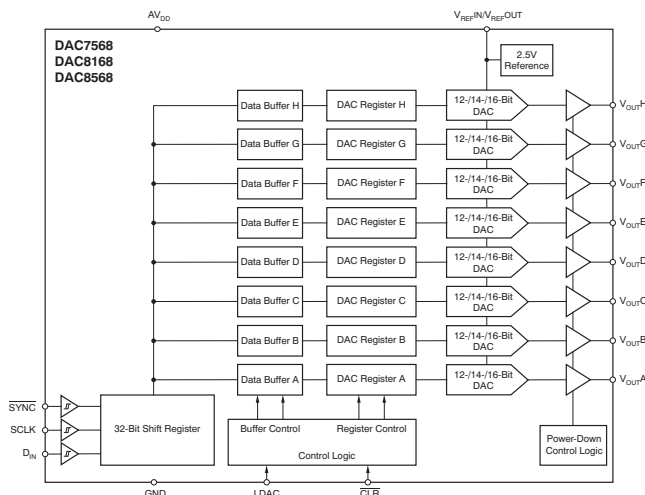

DEVICE COMPARISON	12-BIT	14-BIT	16-BIT
Pin- and Function-Compatible	DAC7568	DAC8168	DAC8568



Please be aware that an important notice concerning availability, standard warranty, and use in critical applications of Texas Instruments semiconductor products and disclaimers thereto appears at the end of this data sheet.

SPI, QSPI are trademarks of Motorola, Inc.

Microwire is a trademark of National Semiconductor.

All other trademarks are the property of their respective owners.

PRODUCTION DATA information is current as of publication date. Products conform to specifications per the terms of the Texas Instruments standard warranty. Production of this document does not necessarily include testing of all parameters.

Copyright © 2009, Texas Instruments Incorporated



This integrated circuit can be damaged by ESD. Texas Instruments recommends that all integrated circuits be handled with appropriate precautions. Failure to observe proper handling and installation procedures can cause damage.

ESD damage can range from subtle performance degradation to complete device failure. Precision integrated circuits may be more susceptible to damage because very small parametric changes could cause the device not to meet its published specifications.

PACKAGE/ORDERING INFORMATION⁽¹⁾

PRODUCT	MAXIMUM RELATIVE ACCURACY (LSB)	MAXIMUM DIFFERENTIAL NONLINEARITY (LSB)	MAXIMUM REFERENCE DRIFT (ppm/°C)	OUTPUT VOLTAGE FULL-SCALE RANGE	RESET TO	PACKAGE-LEAD	PACKAGE DESIGNATOR	SPECIFIED TEMPERATURE RANGE	PACKAGE MARKING
DAC8568A	±12	±1	25	2.5V	Zero	TSSOP-16	PW	–40°C to +125°C	DA8568A
DAC8568B	±12	±1	25	2.5V	Midscale	TSSOP-16	PW	–40°C to +125°C	DA8568B
DAC8568C	±12	±1	5	5V	Zero	TSSOP-16	PW	–40°C to +125°C	DA8568C
DAC8568D	±12	±1	5	5V	Midscale	TSSOP-16	PW	–40°C to +125°C	DA8568D
DAC8168A	±4	±0.5	25	2.5V	Zero	TSSOP-14	PW	–40°C to +125°C	DA8168A
DAC8168C	±4	±0.5	5	5V	Zero	TSSOP-16	PW	–40°C to +125°C	DA8168C
DAC7568A	±1	±0.25	25	2.5V	Zero	TSSOP-14	PW	–40°C to +125°C	DA7568A
DAC7568C	±1	±0.25	5	5V	Zero	TSSOP-16	PW	–40°C to +125°C	DA7568C

(1) For the most current package and ordering information see the Package Option Addendum at the end of this document, or see the TI web site at www.ti.com.

ABSOLUTE MAXIMUM RATINGS⁽¹⁾

Over operating free-air temperature range (unless otherwise noted).

PARAMETER	DAC7568/DAC8168/DAC8568	UNIT
AV _{DD} to GND	–0.3 to +6	V
Digital input voltage to GND	–0.3 to +AV _{DD} + 0.3	V
V _{OUT} to GND	–0.3 to +AV _{DD} + 0.3	V
V _{REF} to GND	–0.3 to +AV _{DD} + 0.3	V
Operating temperature range	–40 to +125	°C
Storage temperature range	–65 to +150	°C
Junction temperature range (T _J max)	+150	°C
Power dissipation	(T _J max – T _A)/θ _{JA}	W
Thermal impedance, θ _{JA}	+118	°C/W
Thermal impedance, θ _{JC}	+29	°C/W

(1) Stresses above those listed under *Absolute Maximum Ratings* may cause permanent damage to the device. Exposure to absolute maximum conditions for extended periods may affect device reliability.

ELECTRICAL CHARACTERISTICS

 At $V_{DD} = 2.7V$ to $5.5V$ and over $-40^{\circ}C$ to $+125^{\circ}C$ (unless otherwise noted).

PARAMETER		TEST CONDITIONS	DAC7568/DAC8168/DAC8568			UNIT
			MIN	TYP	MAX	
STATIC PERFORMANCE⁽¹⁾						
DAC8568	Resolution		16			Bits
	Relative accuracy	Measured by the line passing through codes 485 and 64714		±4	±12	LSB
	Differential nonlinearity	16-bit monotonic		±0.2	±1	LSB
DAC8168	Resolution		14			Bits
	Relative accuracy	Measured by the line passing through codes 120 and 16200		±1	±4	LSB
	Differential nonlinearity	14-bit monotonic		±0.1	±0.5	LSB
DAC7568	Resolution		12			Bits
	Relative accuracy	Measured by the line passing through codes 30 and 4050		±0.3	±1	LSB
	Differential nonlinearity	12-bit monotonic		±0.05	±0.25	LSB
Offset error	Extrapolated from two-point line ⁽¹⁾ , unloaded			±1	±4	mV
Offset error drift				±0.5		μV/°C
Full-scale error	DAC register loaded with all '1's			±0.03	±0.2	% of FSR
Zero-code error	DAC register loaded with all '0's			1	4	mV
Zero-code error drift				±2		μV/°C
Gain error	Extrapolated from two-point line ⁽¹⁾ , unloaded			±0.01	±0.15	% of FSR
Gain temperature coefficient				±1		ppm of FSR/°C
OUTPUT CHARACTERISTICS⁽²⁾						
Output voltage range	$V_{DD} \geq 2.7V$; grades A and B: maximum output voltage 2.5V when using internal reference $V_{DD} \geq 5V$; grades C and D: maximum output voltage 5V when using internal reference		0		V_{DD}	V
Output voltage settling time	DACs unloaded; 1/4 scale to 3/4 scale to ±0.024% $R_L = 1M\Omega$			5	10	μs
Slew rate				0.75		V/μs
Capacitive load stability	$R_L = \infty$ $R_L = 2k\Omega$			1000		pF
Code change glitch impulse	1LSB change around major carry			0.1		nV-s
Digital feedthrough	SCLK toggling, \overline{SYNC} high			0.1		nV-s
Power-on glitch impulse	$R_L = 2k\Omega$, $C_L = 470pF$, $V_{DD} = 5.5V$ $R_L = 2k\Omega$, $C_L = 470pF$, $V_{DD} = 2.7V$			10		mV
Channel-to-channel dc crosstalk	Full-scale swing on adjacent channel			0.1		LSB
Channel-to-channel ac crosstalk	$R_L = 2k\Omega$, $C_L = 420pF$, 1kHz full-scale sine wave, outputs unloaded			-109		dB
DC output impedance	At mid-code input			4		Ω
Short-circuit current	DAC outputs at full-scale, DAC outputs shorted to GND			11		mA
Power-up time, including settling time	Coming out of power-down mode			50		μs

(1) 16-bit: codes 485 and 64714; 14-bit: codes 120 and 16200; 12-bit: codes 30 and 4050

(2) Specified by design or characterization; not production tested.

ELECTRICAL CHARACTERISTICS (continued)

At $V_{DD} = 2.7V$ to $5.5V$ and over $-40^{\circ}C$ to $+125^{\circ}C$ (unless otherwise noted).

PARAMETER	TEST CONDITIONS	DAC7568/DAC8168/DAC8568			UNIT
		MIN	TYP	MAX	
AC PERFORMANCE⁽³⁾					
SNR	$T_A = +25^{\circ}C$, BW = 20kHz, $V_{DD} = 5V$, $f_{OUT} = 1kHz$, first 19 harmonics removed for SNR calculation, at 16-bit level	83			dB
THD		-63			dB
SFDR		63			dB
SINAD		62			dB
DAC output noise density	$T_A = +25^{\circ}C$, at zero-code input, $f_{OUT} = 1kHz$	90			nV/ \sqrt{Hz}
DAC output noise	$T_A = +25^{\circ}C$, at mid-code input, 0.1Hz to 10Hz	2.6			μV_{PP}
REFERENCE					
Internal reference current consumption	$V_{DD} = 5.5V$	360			μA
	$V_{DD} = 3.6V$	348			μA
External reference current	External $V_{REF} = 2.5V$ (when internal reference is disabled), all eight channels active	80			μA
V_{REFIN} Reference input range	Grades A/B, $V_{DD} = 2.7V$ to $5.5V$	0	V_{DD}		V
	Grades C/D, $V_{DD} = 5.0V$ to $5.5V$	0	$V_{DD}/2$		V
Reference input impedance		8			k Ω
REFERENCE OUTPUT					
Output voltage	$T_A = +25^{\circ}C$; all grades	2.4995	2.5	2.5005	V
Initial accuracy	$T_A = +25^{\circ}C$, all grades	-0.02	± 0.004	0.02	%
Output voltage temperature drift	DAC7568/DAC8168/DAC8568 ⁽⁴⁾ , grades A/B	5 25			ppm/ $^{\circ}C$
	DAC7568/DAC8168/DAC8568 ⁽⁵⁾ , grades C/D	2 5			
Output voltage noise	$f = 0.1Hz$ to 10Hz	12			μV_{PP}
Output voltage noise density (high-frequency noise)	$T_A = +25^{\circ}C$, $f = 1MHz$, $C_L = 0\mu F$	50			nV/ \sqrt{Hz}
	$T_A = +25^{\circ}C$, $f = 1MHz$, $C_L = 1\mu F$	20			
	$T_A = +25^{\circ}C$, $f = 1MHz$, $C_L = 4\mu F$	16			
Load regulation, sourcing ⁽⁶⁾	$T_A = +25^{\circ}C$	30			$\mu V/mA$
Load regulation, sinking ⁽⁶⁾	$T_A = +25^{\circ}C$	15			$\mu V/mA$
Output current load capability ⁽³⁾		± 20			mA
Line regulation	$T_A = +25^{\circ}C$	10			$\mu V/V$
Long-term stability/drift (aging) ⁽⁶⁾	$T_A = +25^{\circ}C$, time = 0 to 1900 hours	50			ppm
Thermal hysteresis ⁽⁶⁾	First cycle	100			ppm
	Additional cycles	25			
LOGIC INPUTS⁽³⁾					
Input current		± 1			μA
V_{INL} Logic input LOW voltage	$2.7V \leq V_{DD} \leq 5.5V$	0.8			V
V_{INH} Logic input HIGH voltage	$2.7V \leq V_{DD} \leq 5.5V$	1.8			V
Pin capacitance		3			pF

(3) Specified by design or characterization; not production tested.

(4) Reference is trimmed and tested at room temperature, and is characterized from $-40^{\circ}C$ to $+125^{\circ}C$.

(5) Reference is trimmed and tested at two temperatures ($+25^{\circ}C$ and $+105^{\circ}C$), and is characterized from $-40^{\circ}C$ to $+125^{\circ}C$.

(6) Explained in more detail in the [Application Information](#) section of this data sheet.

ELECTRICAL CHARACTERISTICS (continued)

 At $V_{DD} = 2.7V$ to $5.5V$ and over $-40^{\circ}C$ to $+125^{\circ}C$ (unless otherwise noted).

PARAMETER		TEST CONDITIONS	DAC7568/DAC8168/DAC8568			UNIT
			MIN	TYP	MAX	
POWER REQUIREMENTS						
AV_{DD}			2.7		5.5	V
$I_{DD}^{(7)}$	Normal mode, internal reference switched off	$AV_{DD} = 3.6V$ to $5.5V$ $V_{INH} = AV_{DD}$ and $V_{INL} = GND$		0.95	1.4	mA
		$AV_{DD} = 2.7V$ to $3.6V$ $V_{INH} = AV_{DD}$ and $V_{INL} = GND$		0.81	1.3	
	Normal mode, internal reference switched on	$AV_{DD} = 3.6V$ to $5.5V$ $V_{INH} = AV_{DD}$ and $V_{INL} = GND$		1.25	2.0	mA
		$AV_{DD} = 2.7V$ to $3.6V$ $V_{INH} = AV_{DD}$ and $V_{INL} = GND$		1.1	1.9	
	All power-down modes	$AV_{DD} = 3.6V$ to $5.5V$ $V_{INH} = AV_{DD}$ and $V_{INL} = GND$		0.18	3	μA
		$AV_{DD} = 2.7V$ to $3.6V$ $V_{INH} = AV_{DD}$ and $V_{INL} = GND$		0.10	2.5	
Power dissipation ⁽⁷⁾	Normal mode, internal reference switched off	$AV_{DD} = 3.6V$ to $5.5V$ $V_{INH} = AV_{DD}$ and $V_{INL} = GND$		3.4	7.7	mW
		$AV_{DD} = 2.7V$ to $3.6V$ $V_{INH} = AV_{DD}$ and $V_{INL} = GND$		2.2	4.7	
	Normal mode, internal reference switched on	$AV_{DD} = 3.6V$ to $5.5V$ $V_{INH} = AV_{DD}$ and $V_{INL} = GND$		4.5	11	mW
		$AV_{DD} = 2.7V$ to $3.6V$ $V_{INH} = AV_{DD}$ and $V_{INL} = GND$		2.9	6.8	
	All power-down modes	$AV_{DD} = 3.6V$ to $5.5V$ $V_{INH} = AV_{DD}$ and $V_{INL} = GND$		0.6	16	μW
		$AV_{DD} = 2.7V$ to $3.6V$ $V_{INH} = AV_{DD}$ and $V_{INL} = GND$		0.3	9	
TEMPERATURE RANGE						
Specified performance			-40		+125	$^{\circ}C$

(7) Input code = midscale, no load.

PIN CONFIGURATIONS

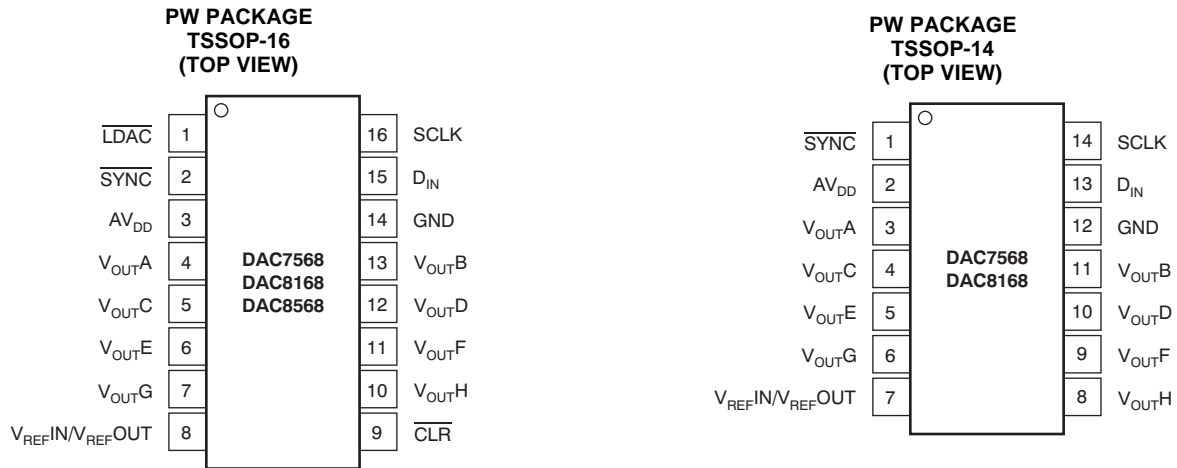

PIN DESCRIPTIONS

16-PIN	14-PIN	NAME	DESCRIPTION
1	—	LDAC	Load DACs.
2	1	SYNC	Level-triggered control input (active low). This input is the frame synchronization signal for the input data. When SYNC goes low, it enables the input shift register, and data are sampled on subsequent falling clock edges. The DAC output updates following the 32nd clock. If SYNC is taken high before the 31st clock edge, the rising edge of SYNC acts as an interrupt, and the write sequence is ignored by the DAC7568/DAC8168/DAC8568. Schmitt-Trigger logic input.
3	2	AV _{DD}	Power-supply input, 2.7V to 5.5V
4	3	V _{OUTA}	Analog output voltage from DAC A
5	4	V _{OUTC}	Analog output voltage from DAC C
6	5	V _{OUTE}	Analog output voltage from DAC E
7	6	V _{OUTG}	Analog output voltage from DAC G
8	7	V _{REFIN} / V _{REFOUT}	Positive reference input / reference output 2.5V if internal reference used. ⁽¹⁾
9	—	CLR	Asynchronous clear input.
10	8	V _{OUTH}	Analog output voltage from DAC H
11	9	V _{OUTF}	Analog output voltage from DAC F
12	10	V _{OUTD}	Analog output voltage from DAC D
13	11	V _{OUTB}	Analog output voltage from DAC B
14	12	GND	Ground reference point for all circuitry on the device
15	13	D _{IN}	Serial data input. Data are clocked into the 32-bit input shift register on each falling edge of the serial clock input. Schmitt-Trigger logic input.
16	14	SCLK	Serial clock input. Data can be transferred at rates up to 50MHz. Schmitt-Trigger logic input.

(1) Grades A and B, external V_{REFIN} (max) ≤ AV_{DD}; grades C and D, external V_{REFIN} (max) ≤ AV_{DD}/2.

TIMING DIAGRAM

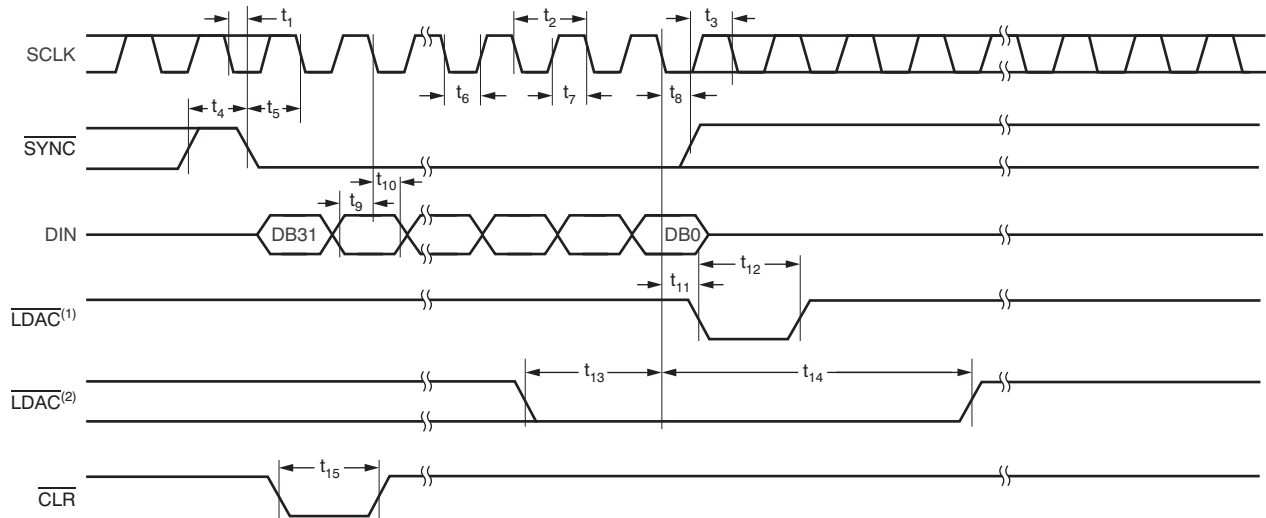

- (1) Asynchronous LDAC update mode. For more information and details, see the [LDAC Functionality](#) section.
 (2) Synchronous LDAC update mode. For more information and details, see the [LDAC Functionality](#) section.

Figure 1. Serial Write Operation

TIMING REQUIREMENTS⁽¹⁾⁽²⁾

At $V_{DD} = 2.7V$ to $5.5V$ and over $-40^{\circ}C$ to $+125^{\circ}C$ (unless otherwise noted).

PARAMETER	TEST CONDITIONS	DAC7568/DAC8168/DAC8568			UNIT
		MIN	TYP	MAX	
t_1 SCLK falling edge to \overline{SYNC} falling edge (for successful write operation)	$V_{DD} = 2.7V$ to $5.5V$	10			ns
$t_2^{(3)}$ SCLK cycle time	$V_{DD} = 2.7V$ to $5.5V$	20			ns
t_3 \overline{SYNC} rising edge to 31st SCLK falling edge (for successful \overline{SYNC} interrupt)	$V_{DD} = 2.7V$ to $5.5V$	13			ns
t_4 Minimum \overline{SYNC} HIGH time	$V_{DD} = 2.7V$ to $5.5V$	80			ns
t_5 \overline{SYNC} to SCLK falling edge setup time	$V_{DD} = 2.7V$ to $5.5V$	13			ns
t_6 SCLK LOW time	$V_{DD} = 2.7V$ to $5.5V$	8			ns
t_7 SCLK HIGH time	$V_{DD} = 2.7V$ to $5.5V$	8			ns
t_8 SCLK falling edge to \overline{SYNC} rising edge	$V_{DD} = 2.7V$ to $5.5V$	10			ns
t_9 Data setup time	$V_{DD} = 2.7V$ to $5.5V$	6			ns
t_{10} Data hold time	$V_{DD} = 2.7V$ to $5.5V$	4			ns
t_{11} SCLK falling edge to \overline{LDAC} falling edge for asynchronous LDAC update mode	$V_{DD} = 2.7V$ to $5.5V$	40			ns
t_{12} \overline{LDAC} pulse width LOW time	$V_{DD} = 2.7V$ to $5.5V$	80			ns
t_{13} \overline{LDAC} falling edge to SCLK falling edge for synchronous LDAC update mode	$V_{DD} = 2.7V$ to $5.5V$	$4 \times t_1$			ns
t_{14} 32nd SCLK falling edge to \overline{LDAC} rising edge	$V_{DD} = 2.7V$ to $5.5V$	40			ns
t_{15} \overline{CLR} pulse width LOW time	$V_{DD} = 2.7V$ to $5.5V$	80			ns

- (1) All input signals are specified with $t_R = t_F = 3ns$ (10% to 90% of V_{DD}) and timed from a voltage level of $(V_{IL} + V_{IH})/2$.
 (2) See the [Serial Write Operation](#) timing diagram.
 (3) Maximum SCLK frequency is 50MHz at $V_{DD} = 2.7V$ to $5.5V$.

TYPICAL CHARACTERISTICS: Internal Reference

At $T_A = +25^\circ\text{C}$, unless otherwise noted.

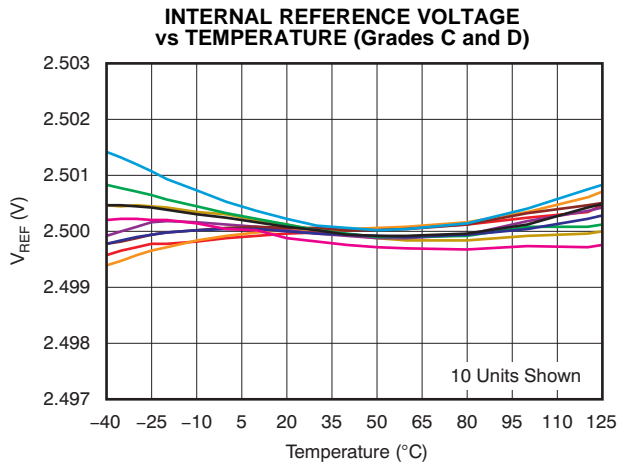

Figure 2.

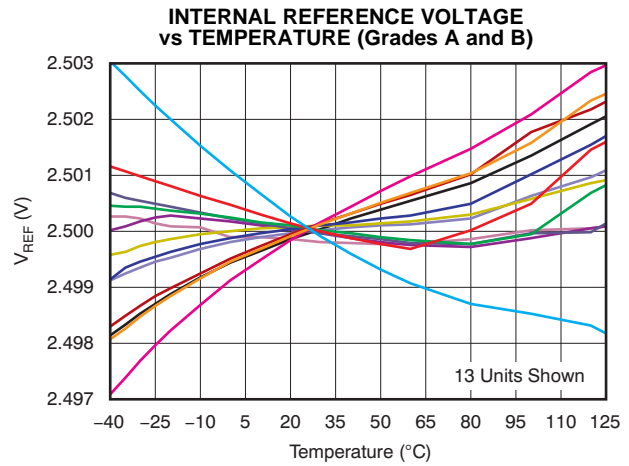

Figure 3.

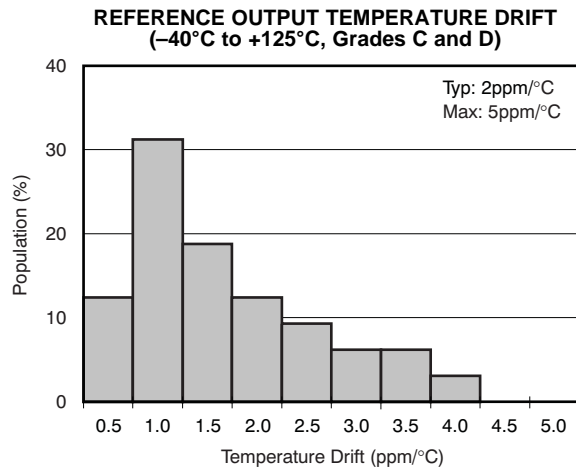

Figure 4.

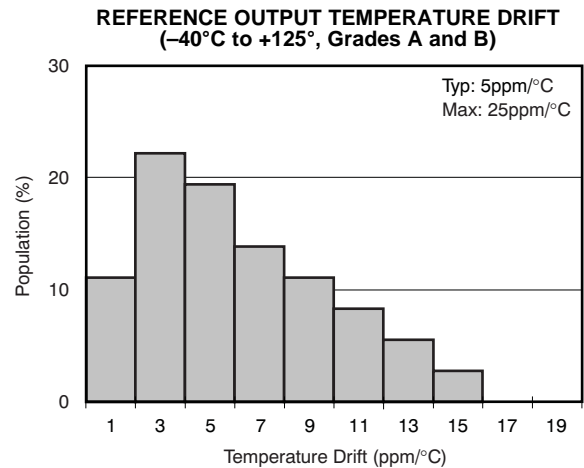

Figure 5.

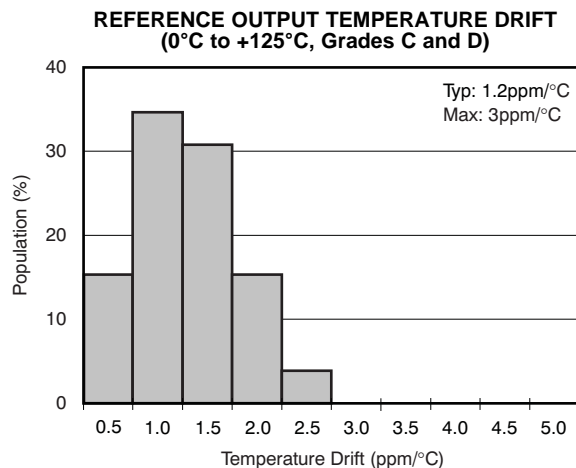

Figure 6.

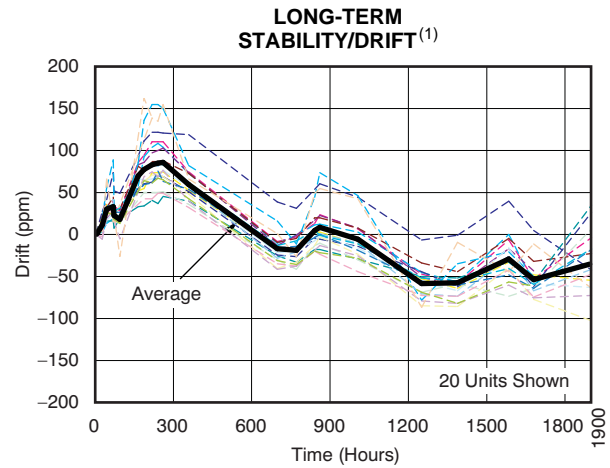

Figure 7.

(1) See the [Application Information](#) section of this data sheet for more details.

TYPICAL CHARACTERISTICS: Internal Reference (continued)

At $T_A = +25^\circ\text{C}$, unless otherwise noted.

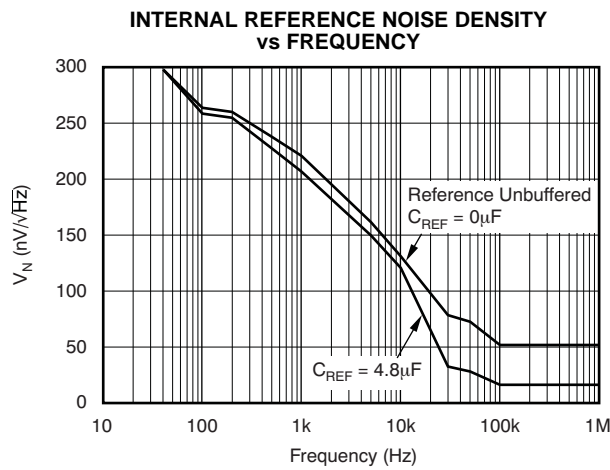

Figure 8.

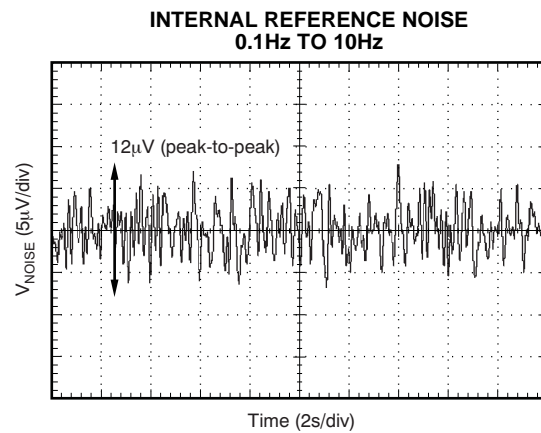

Figure 9.

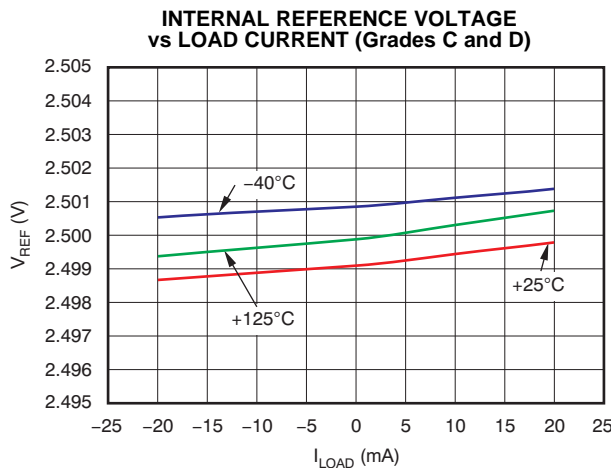

Figure 10.

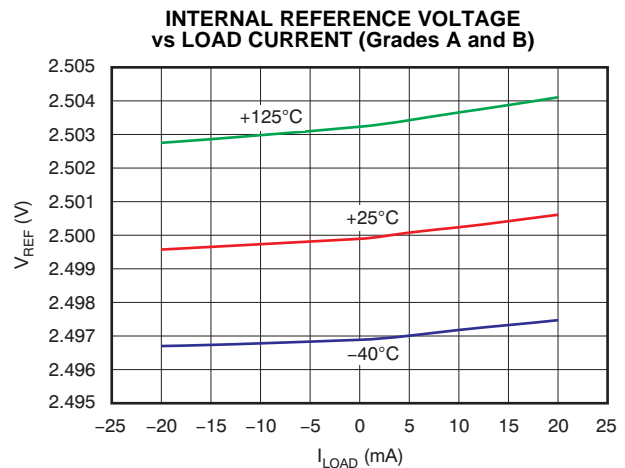

Figure 11.

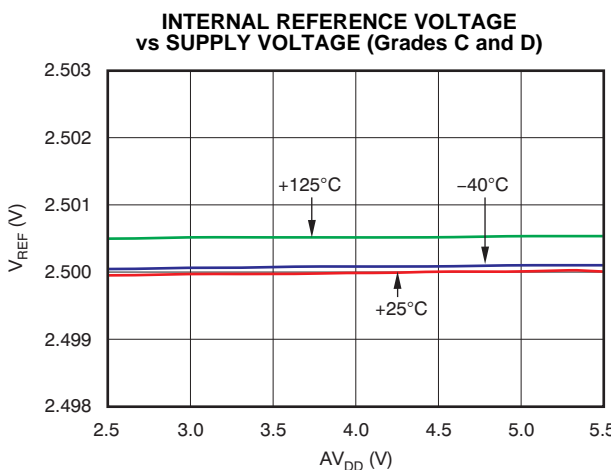

Figure 12.

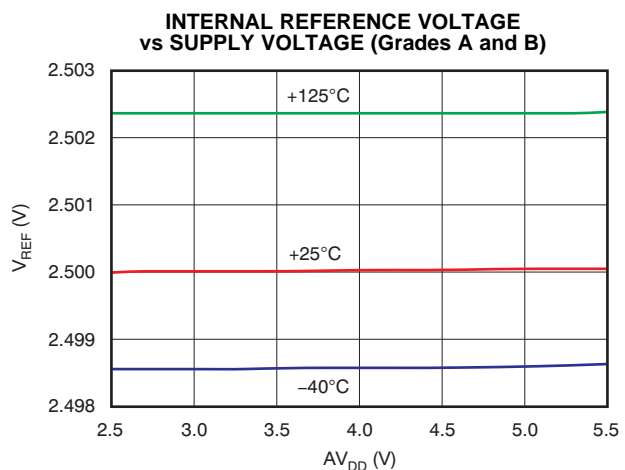

Figure 13.

TYPICAL CHARACTERISTICS: DAC at $V_{DD} = 5.5V$

Channel-specific information provided as examples. At $T_A = +25^\circ C$, external reference used, DAC output not loaded, and all DAC codes in straight binary data format, unless otherwise noted.

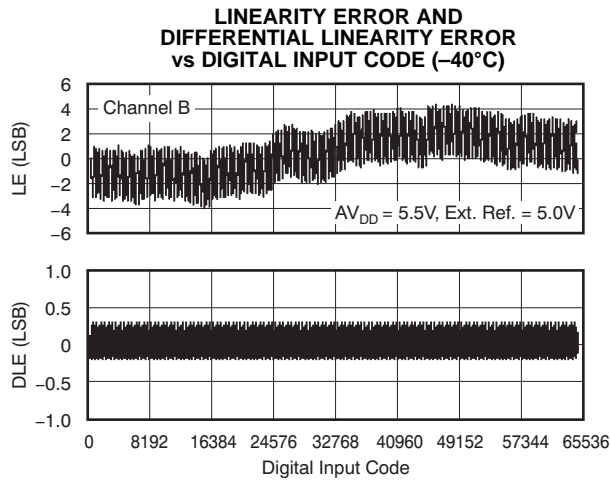

Figure 14.

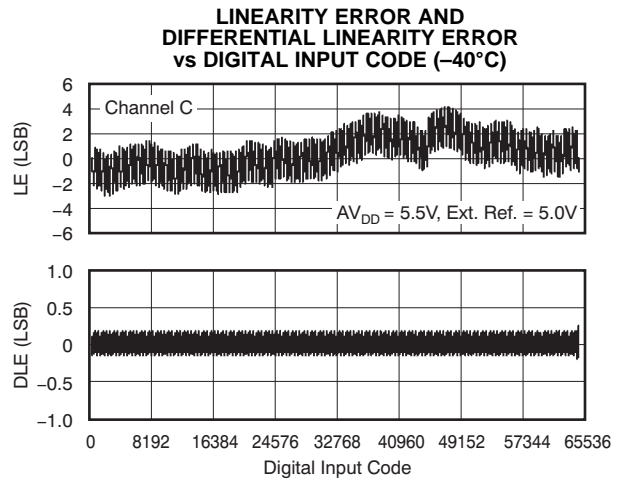

Figure 15.

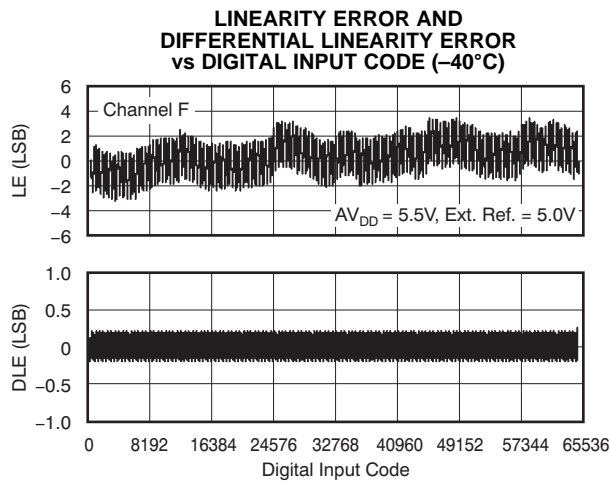

Figure 16.

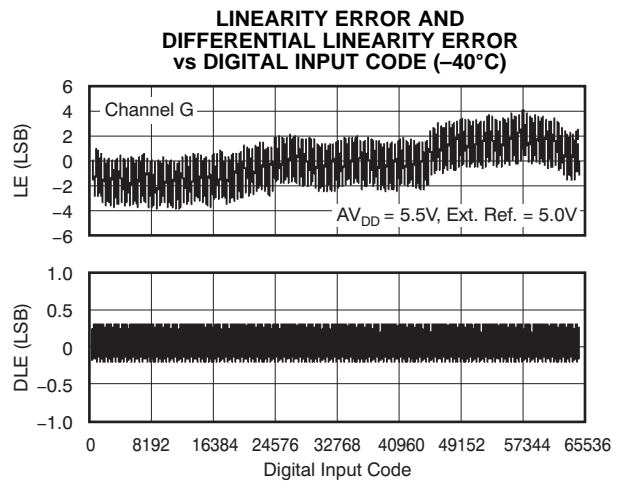

Figure 17.

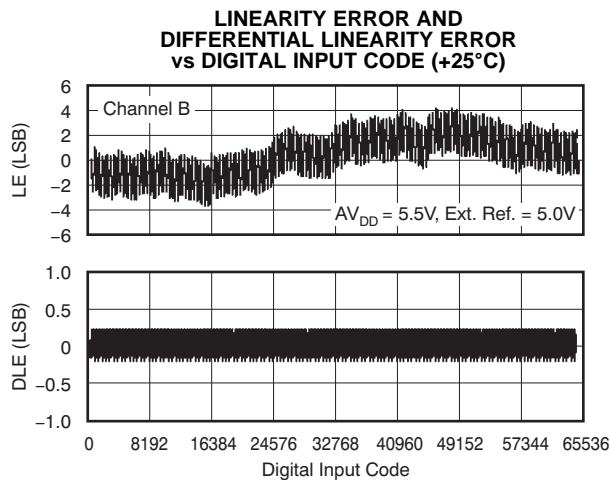

Figure 18.

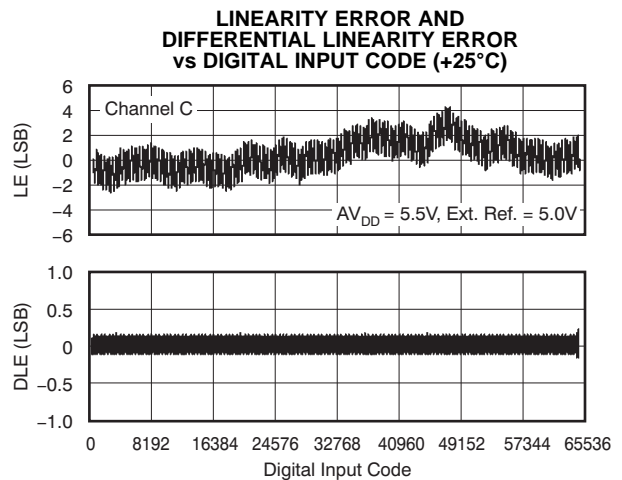

Figure 19.

TYPICAL CHARACTERISTICS: DAC at AV_{DD} = 5.5V (continued)

Channel-specific information provided as examples. At T_A = +25°C, external reference used, DAC output not loaded, and all DAC codes in straight binary data format, unless otherwise noted.

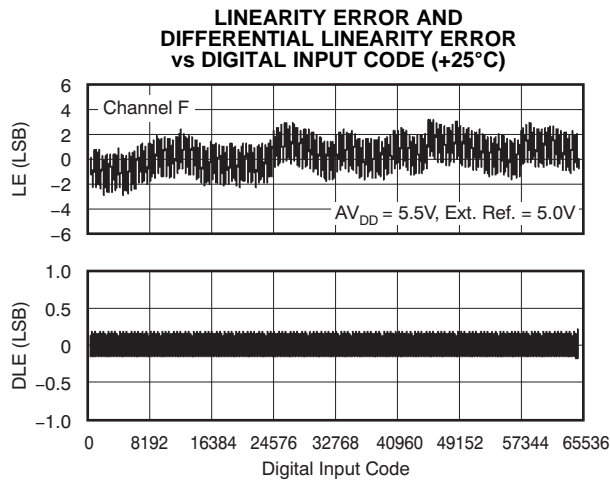

Figure 20.

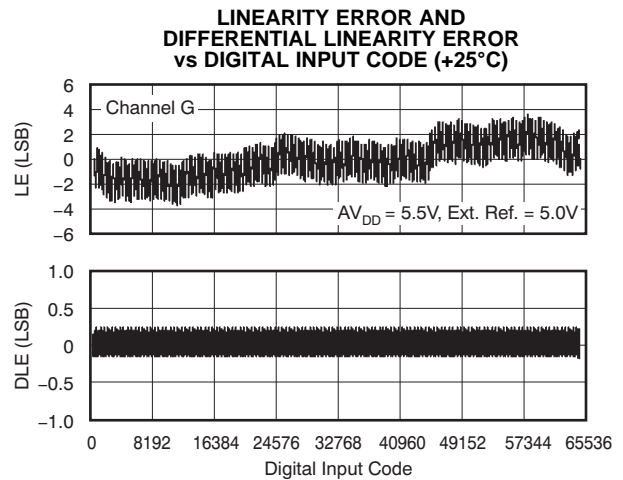

Figure 21.

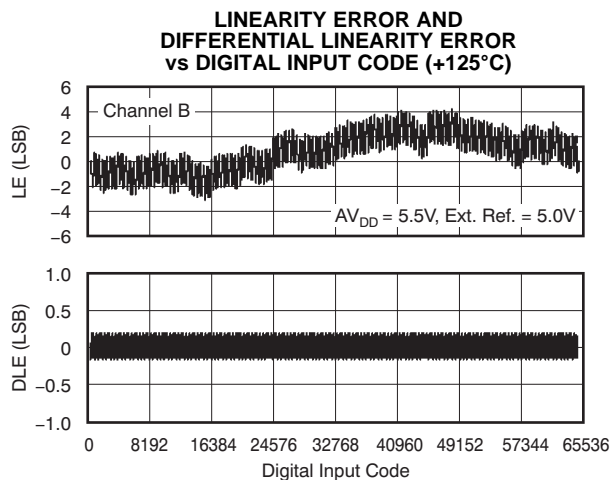

Figure 22.

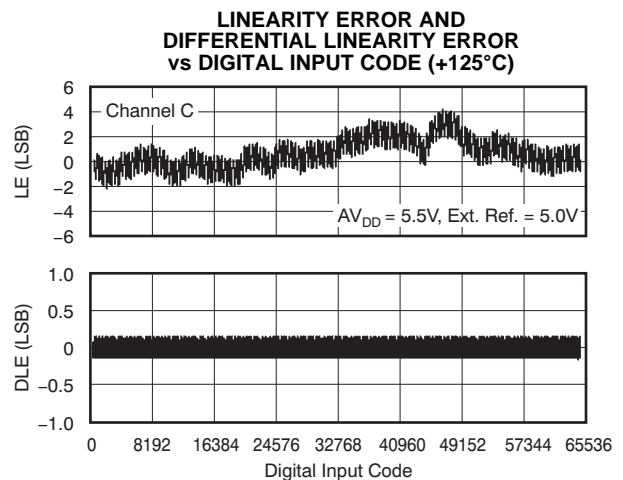

Figure 23.

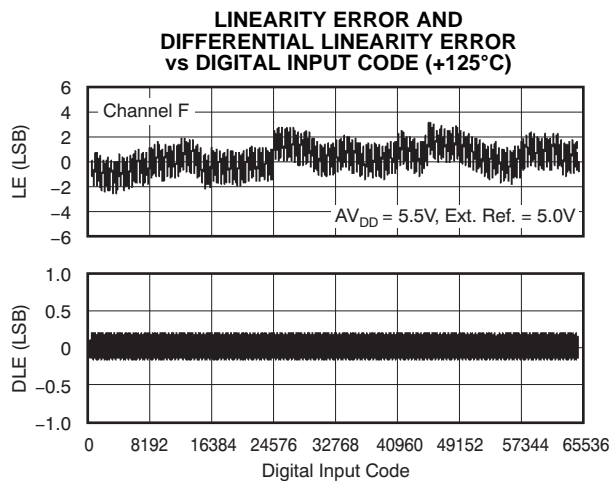

Figure 24.

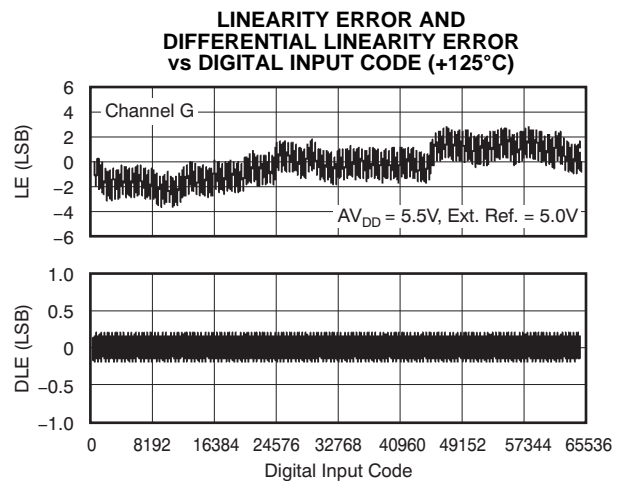

Figure 25.

TYPICAL CHARACTERISTICS: DAC at AV_{DD} = 5.5V (continued)

Channel-specific information provided as examples. At T_A = +25°C, external reference used, DAC output not loaded, and all DAC codes in straight binary data format, unless otherwise noted.

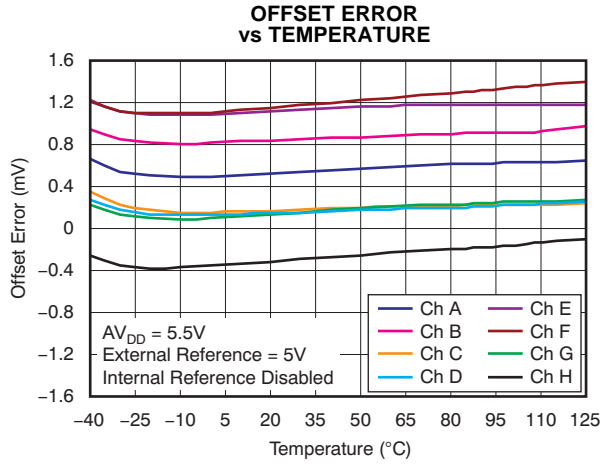

Figure 26.

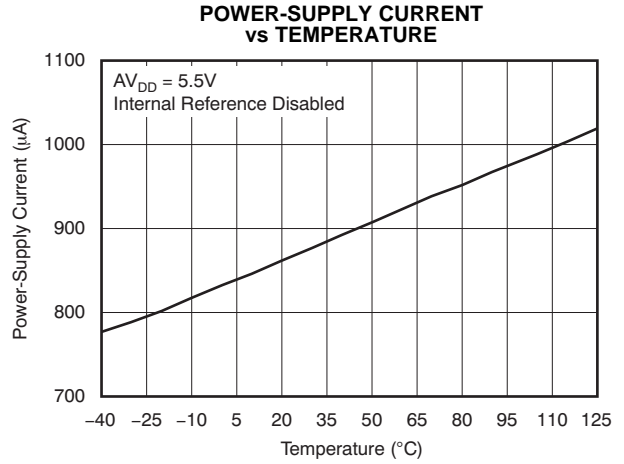

Figure 27.

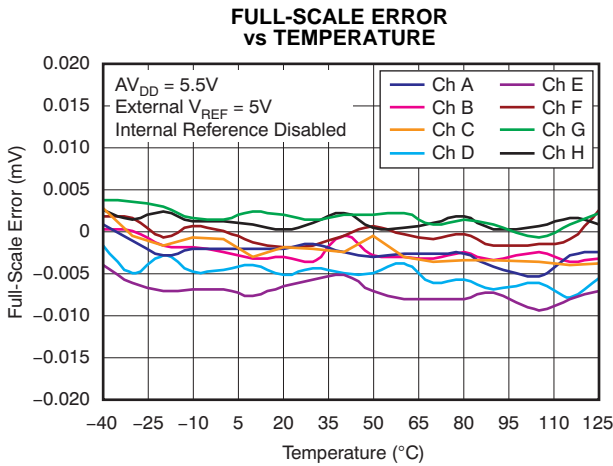

Figure 28.

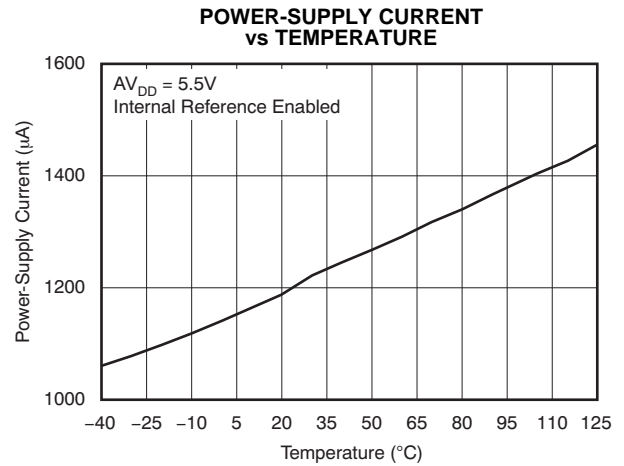

Figure 29.

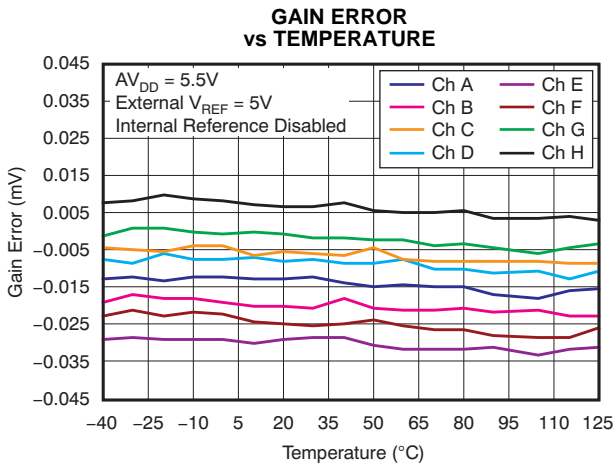

Figure 30.

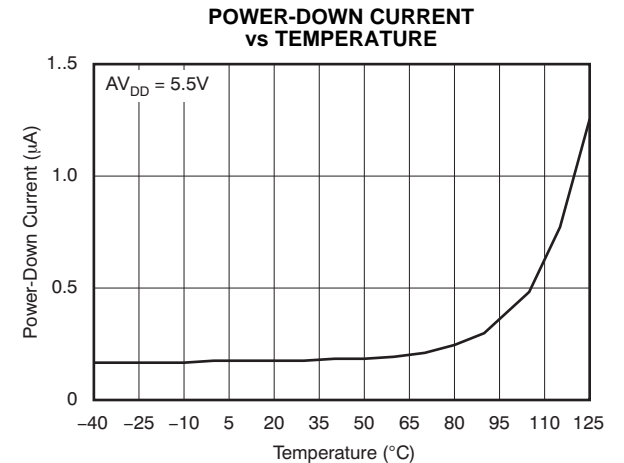

Figure 31.

TYPICAL CHARACTERISTICS: DAC at AV_{DD} = 5.5V (continued)

Channel-specific information provided as examples. At T_A = +25°C, external reference used, DAC output not loaded, and all DAC codes in straight binary data format, unless otherwise noted.

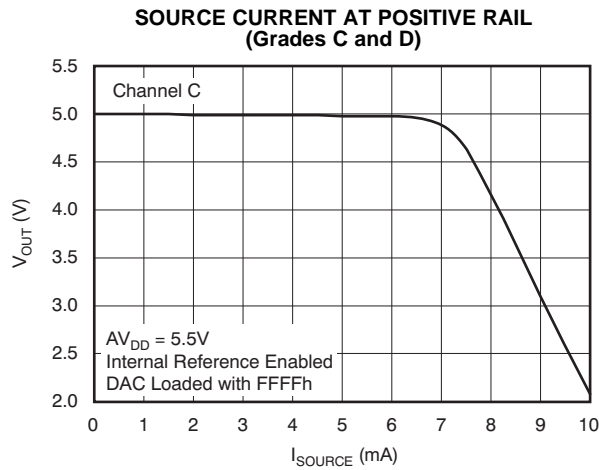

Figure 32.

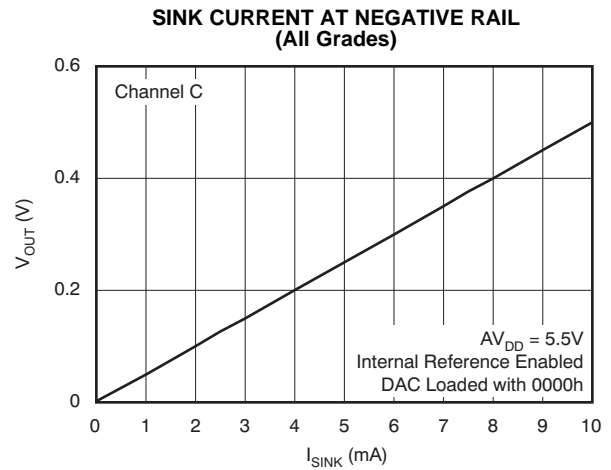

Figure 33.

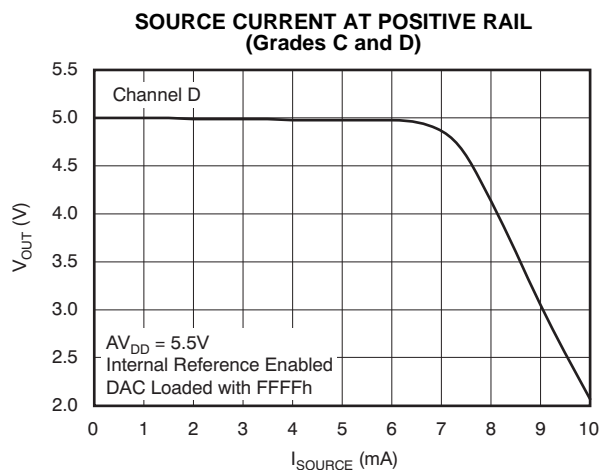

Figure 34.

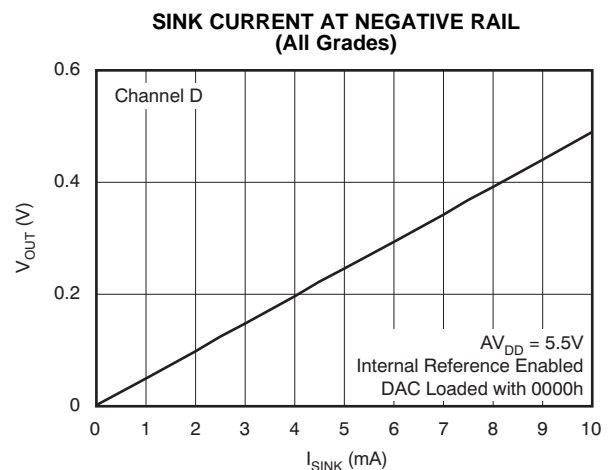

Figure 35.

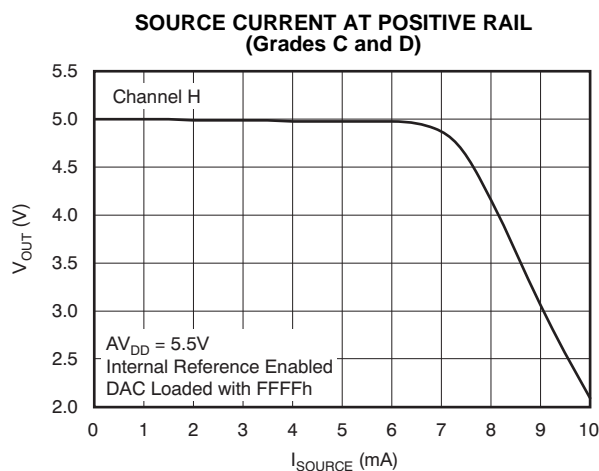

Figure 36.

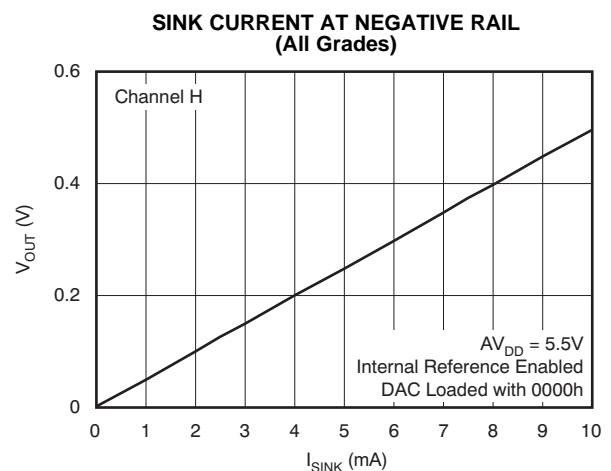

Figure 37.

TYPICAL CHARACTERISTICS: DAC at $AV_{DD} = 5.5V$ (continued)

Channel-specific information provided as examples. At $T_A = +25^\circ C$, external reference used, DAC output not loaded, and all DAC codes in straight binary data format, unless otherwise noted.

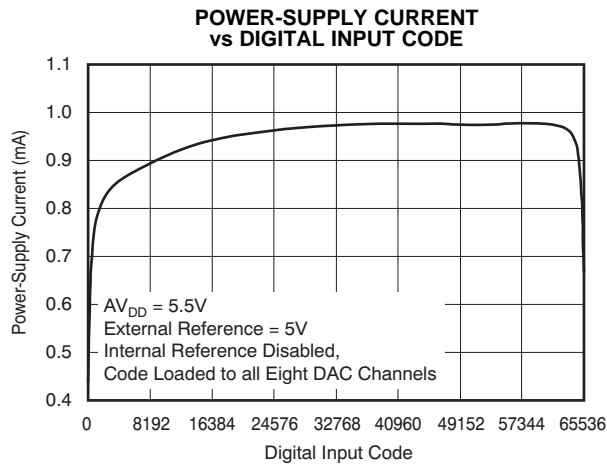

Figure 38.

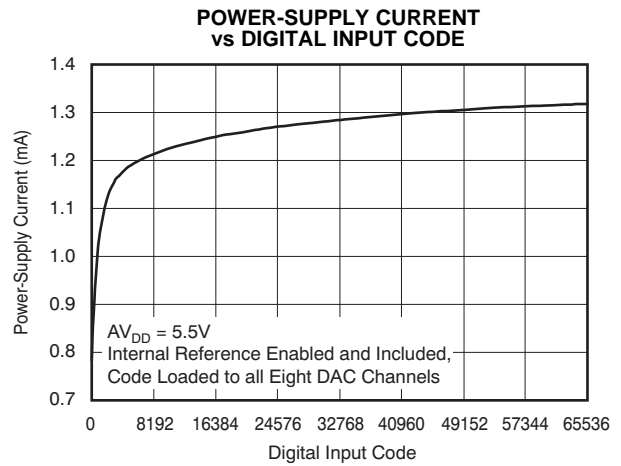

Figure 39.

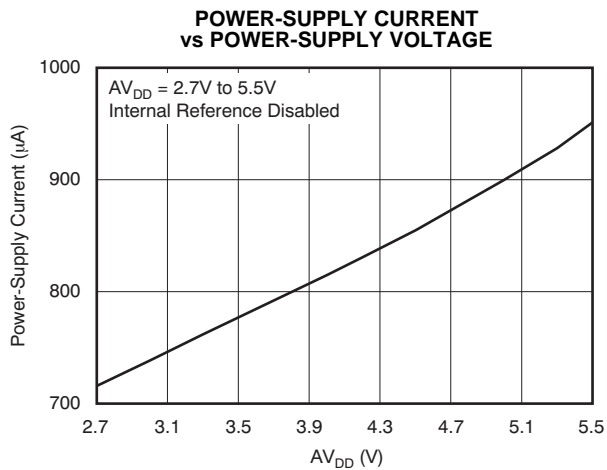

Figure 40.

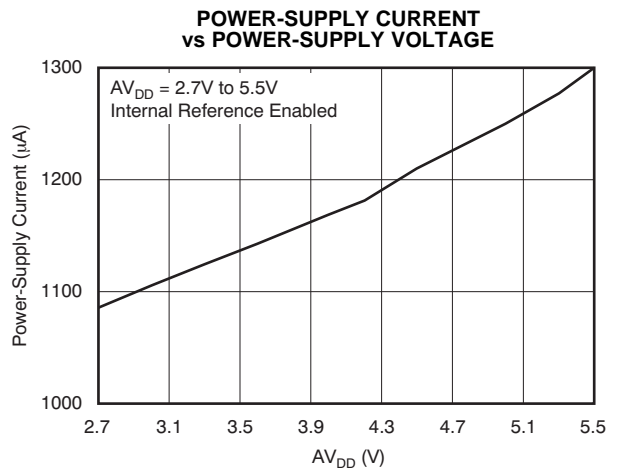

Figure 41.

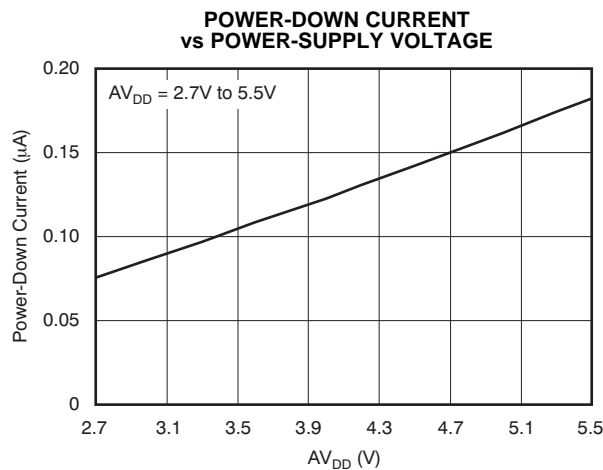

Figure 42.

TYPICAL CHARACTERISTICS: DAC at AV_{DD} = 5.5V (continued)

Channel-specific information provided as examples. At T_A = +25°C, external reference used, DAC output not loaded, and all DAC codes in straight binary data format, unless otherwise noted.

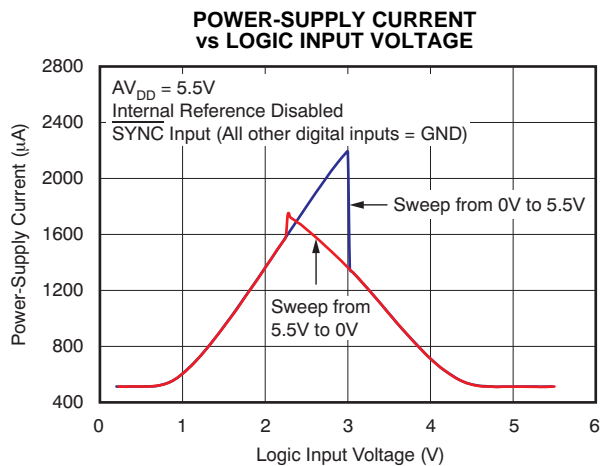

Figure 43.

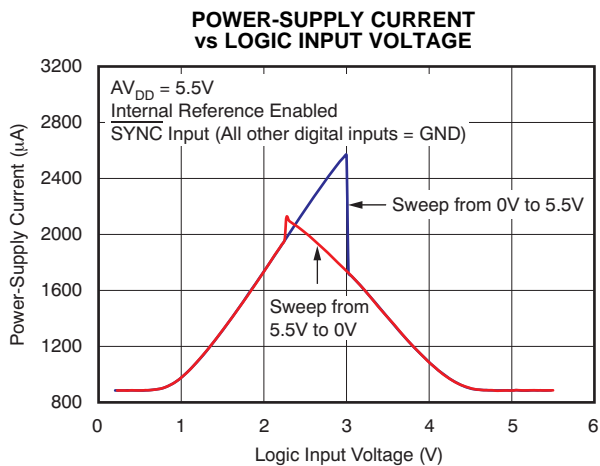

Figure 44.

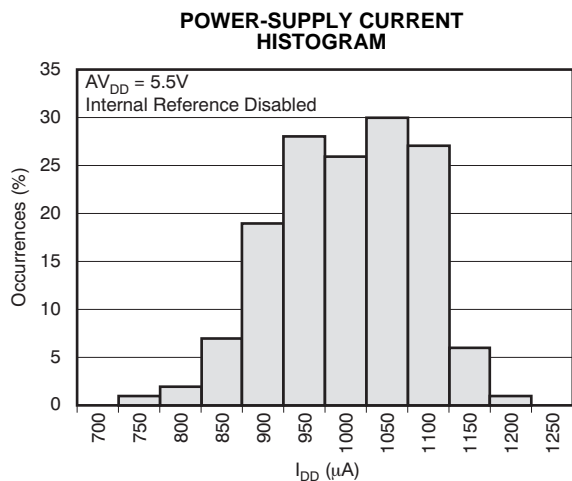

Figure 45.

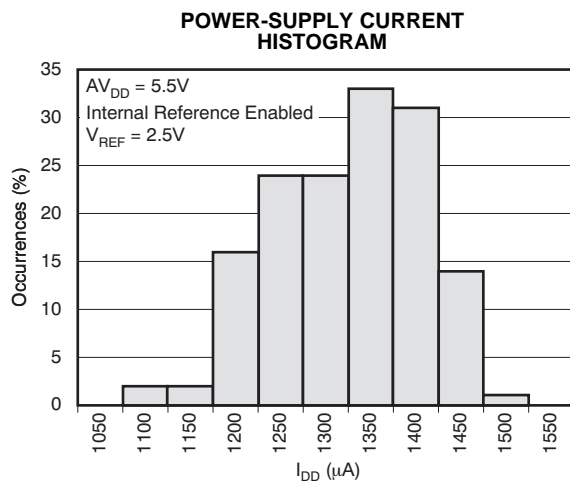

Figure 46.

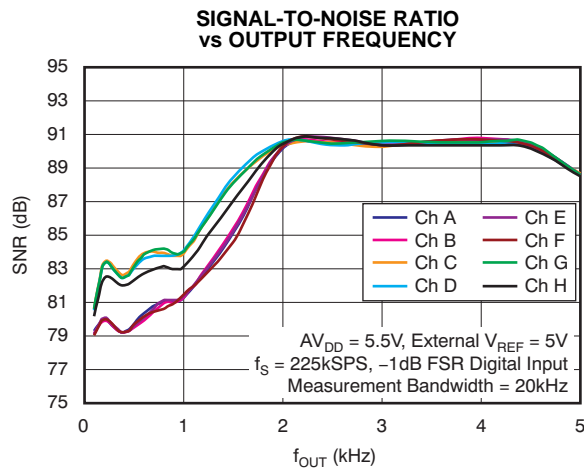

Figure 47.

TYPICAL CHARACTERISTICS: DAC at AV_{DD} = 5.5V (continued)

Channel-specific information provided as examples. At T_A = +25°C, external reference used, DAC output not loaded, and all DAC codes in straight binary data format, unless otherwise noted.

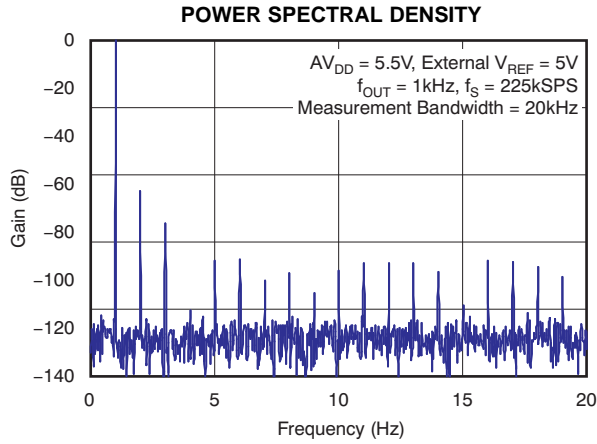

Figure 48.

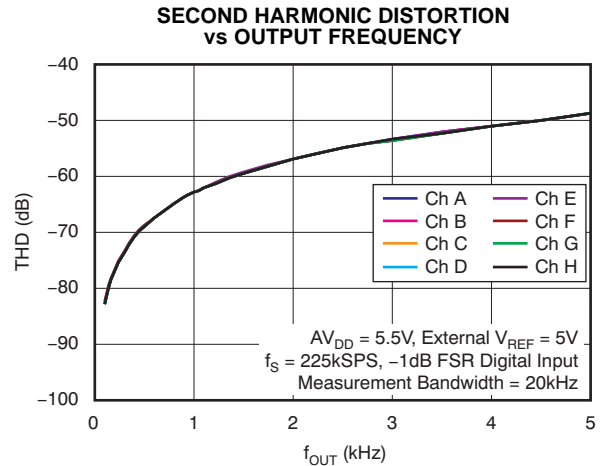

Figure 49.

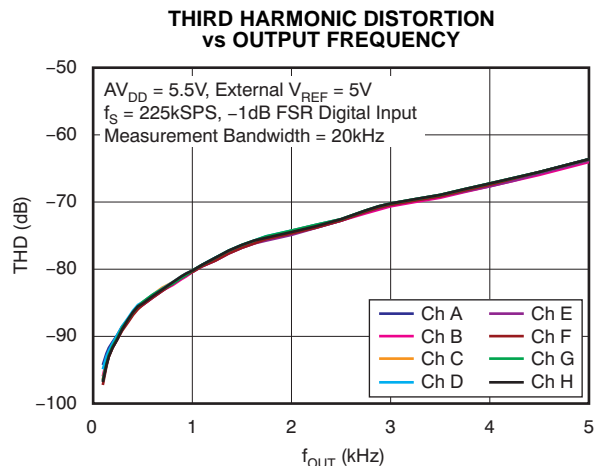

Figure 50.

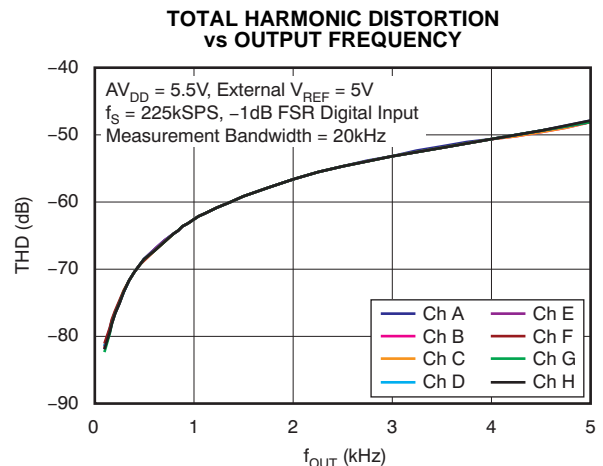

Figure 51.

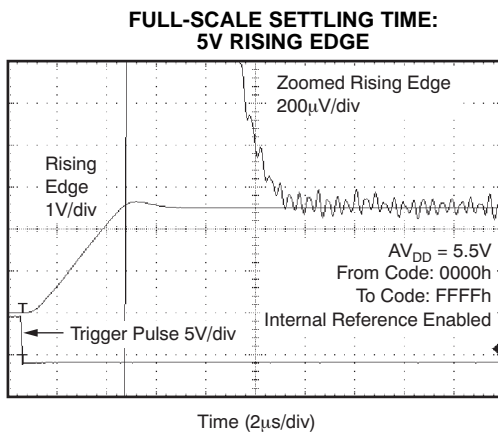

Figure 52.

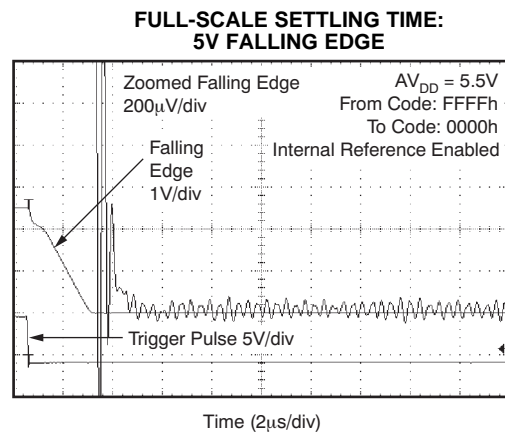
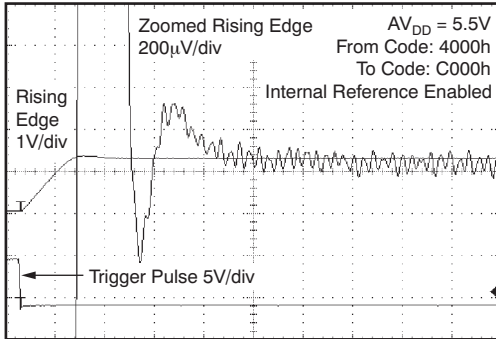

Figure 53.

TYPICAL CHARACTERISTICS: DAC at AV_{DD} = 5.5V (continued)

Channel-specific information provided as examples. At T_A = +25°C, external reference used, DAC output not loaded, and all DAC codes in straight binary data format, unless otherwise noted.

**HALF-SCALE SETTLING TIME:
5V RISING EDGE**



Time (2µs/div)

Figure 54.

**HALF-SCALE SETTLING TIME:
5V FALLING EDGE**

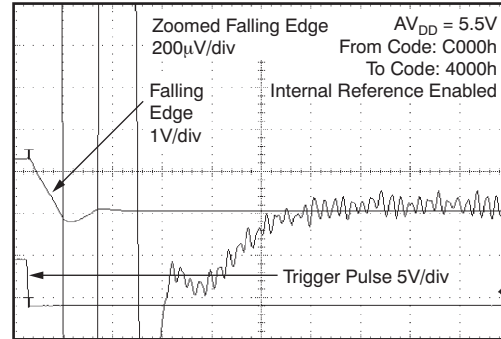

Time (2µs/div)

Figure 55.

**CLOCK FEEDTHROUGH
2MHz, MIDSACLE**

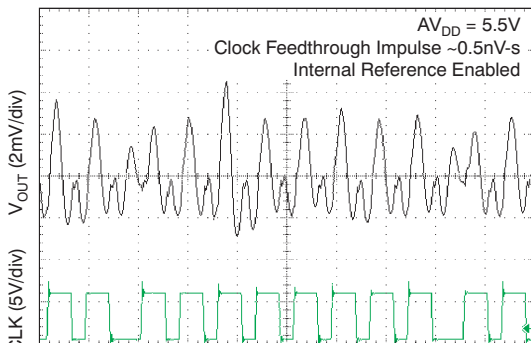

Time (1µs/div)

Figure 56.

**POWER-ON GLITCH
RESET TO ZERO SCALE**

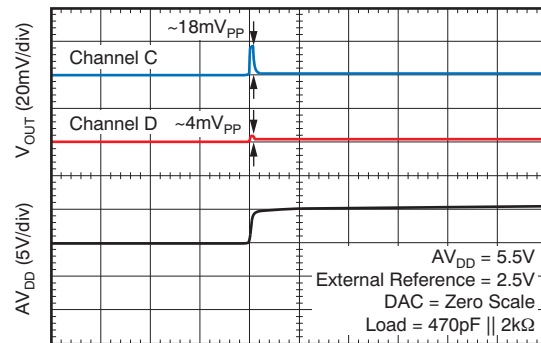

Time (4ms/div)

Figure 57.

**POWER-ON GLITCH
RESET TO MIDSACLE**

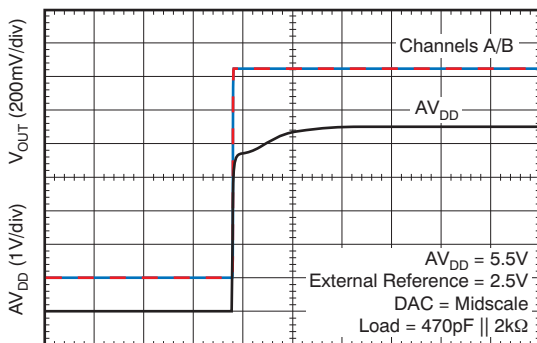

Time (20ms/div)

Figure 58.

POWER-OFF GLITCH

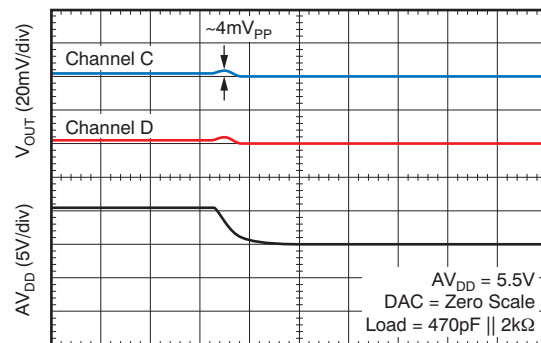

Time (4ms/div)

Figure 59.

TYPICAL CHARACTERISTICS: DAC at AV_{DD} = 5.5V (continued)

Channel-specific information provided as examples. At T_A = +25°C, external reference used, DAC output not loaded, and all DAC codes in straight binary data format, unless otherwise noted.

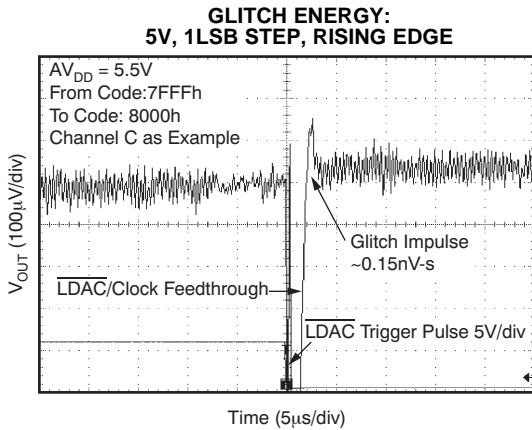

Figure 60.

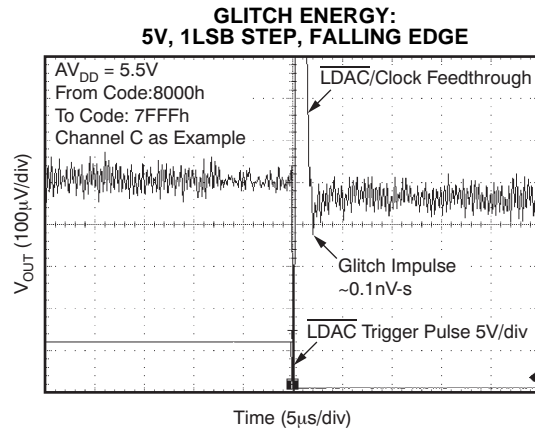

Figure 61.

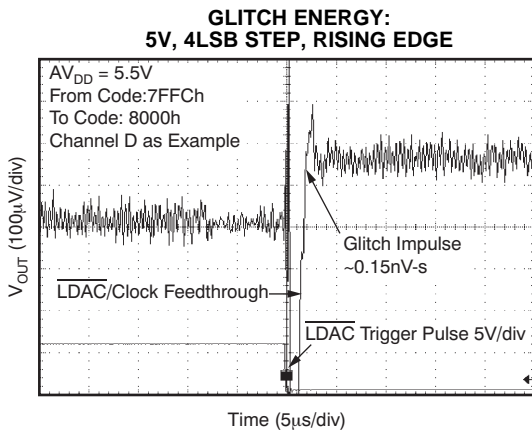

Figure 62.

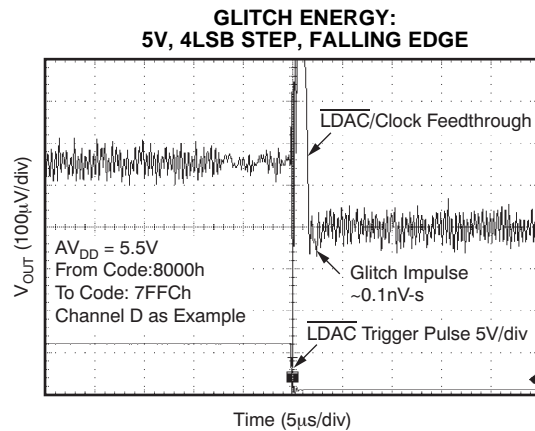

Figure 63.

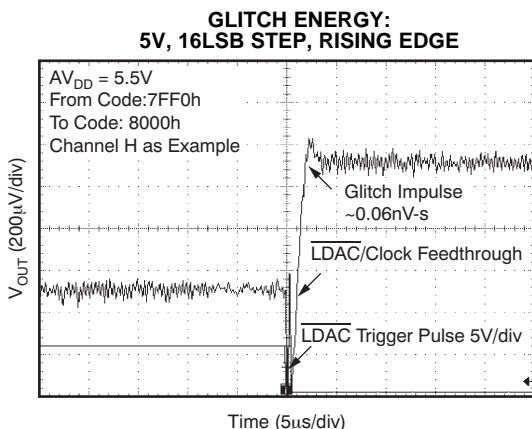

Figure 64.

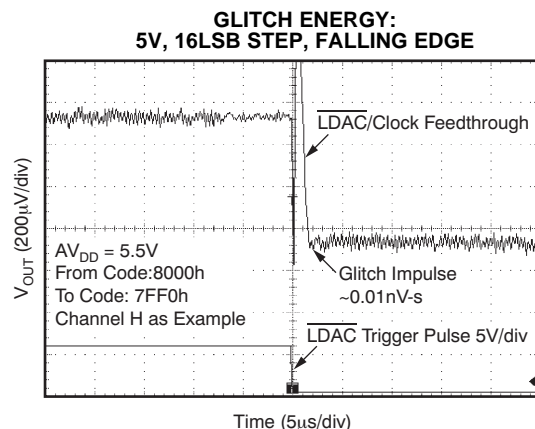

Figure 65.

TYPICAL CHARACTERISTICS: DAC at AV_{DD} = 5.5V (continued)

Channel-specific information provided as examples. At T_A = +25°C, external reference used, DAC output not loaded, and all DAC codes in straight binary data format, unless otherwise noted.

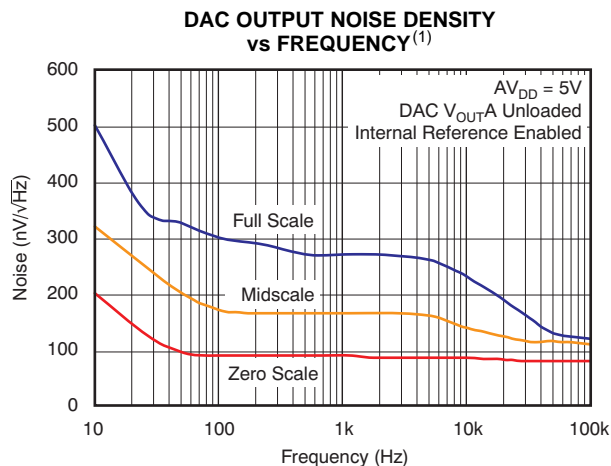

Figure 66.

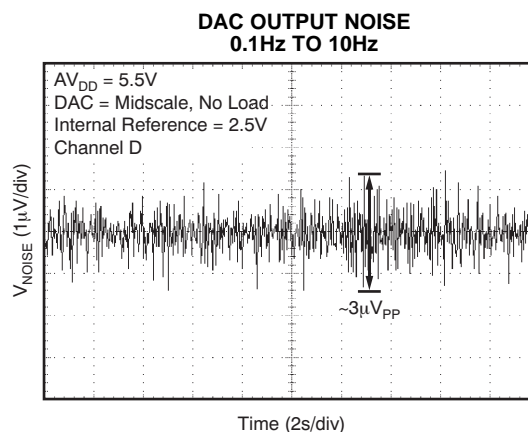

Figure 67.

(1) See the [Application Information](#) section of this data sheet for more details.

TYPICAL CHARACTERISTICS: DAC at AV_{DD} = 3.6V

Channel-specific information provided as examples. At T_A = +25°C, internal reference used, and DAC output not loaded, all DAC codes in straight binary data format, unless otherwise noted

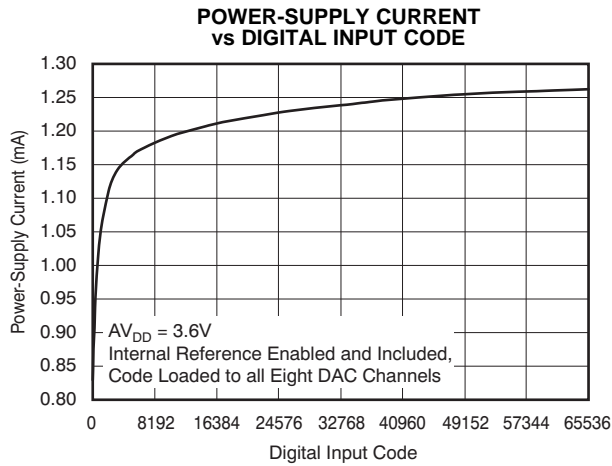

Figure 68.

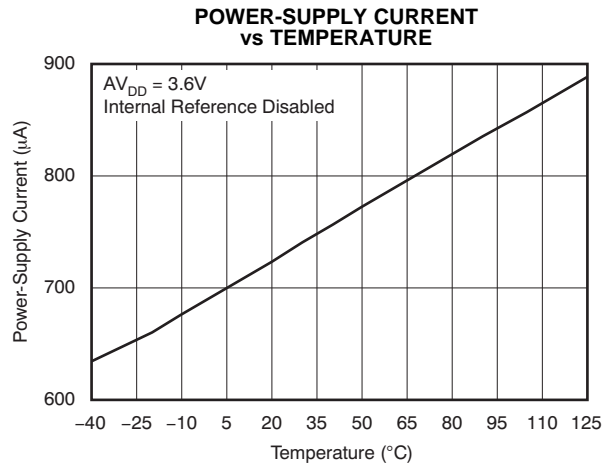

Figure 69.

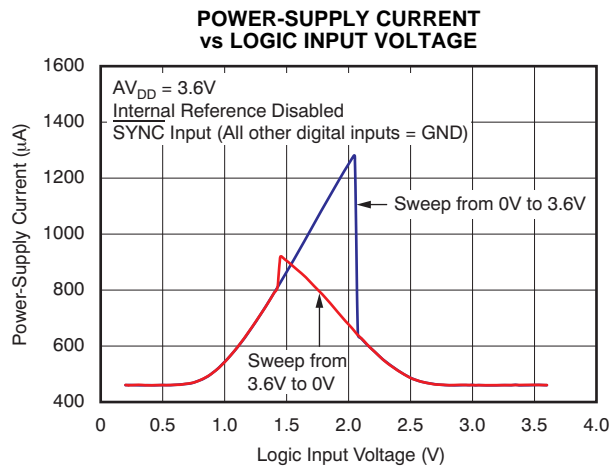

Figure 70.

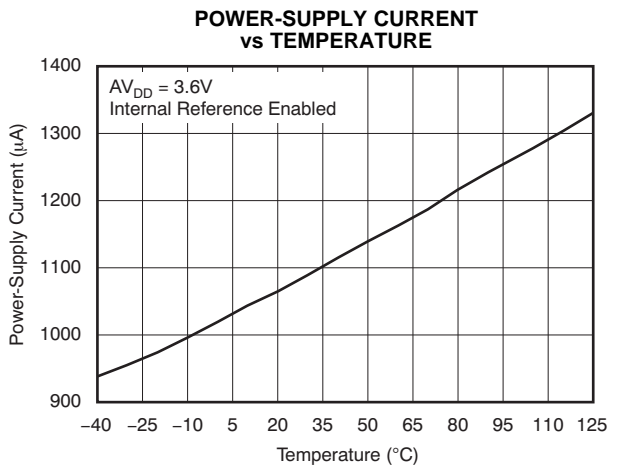

Figure 71.

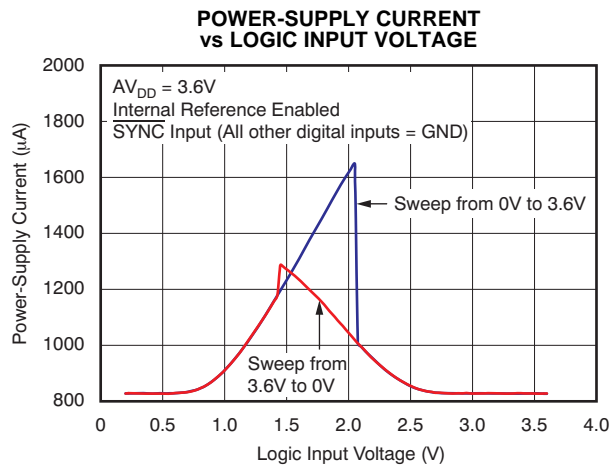

Figure 72.

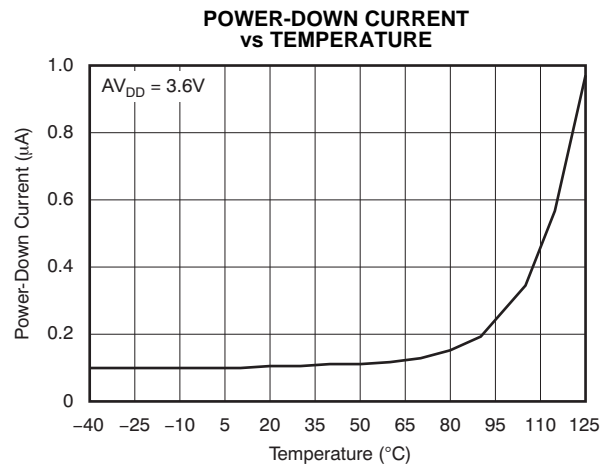

Figure 73.

TYPICAL CHARACTERISTICS: DAC at AV_{DD} = 3.6V (continued)

Channel-specific information provided as examples. At T_A = +25°C, internal reference used, and DAC output not loaded, all DAC codes in straight binary data format, unless otherwise noted

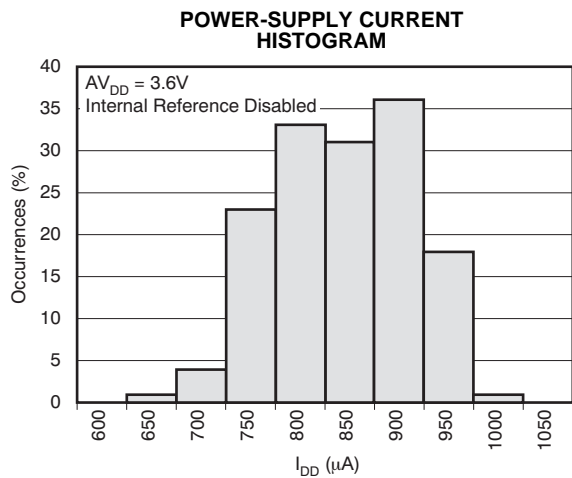

Figure 74.

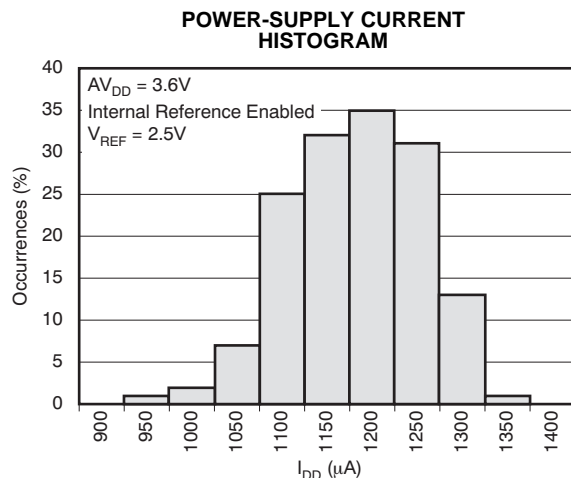

Figure 75.

TYPICAL CHARACTERISTICS: DAC at $V_{DD} = 2.7V$

Channel-specific information provided as examples. At $T_A = +25^\circ C$, internal reference used, and DAC output not loaded, all DAC codes in straight binary data format, unless otherwise noted

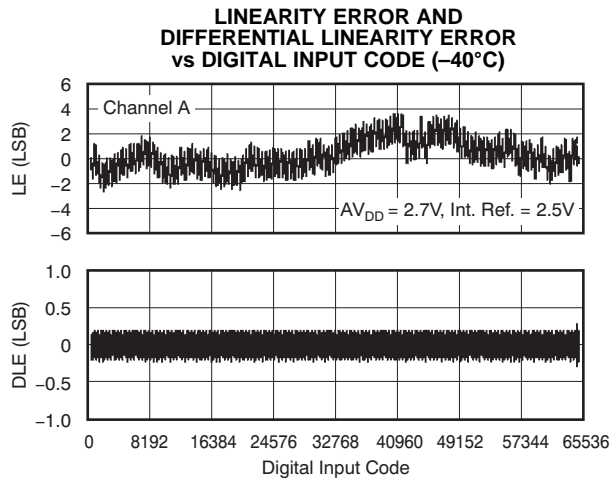

Figure 76.

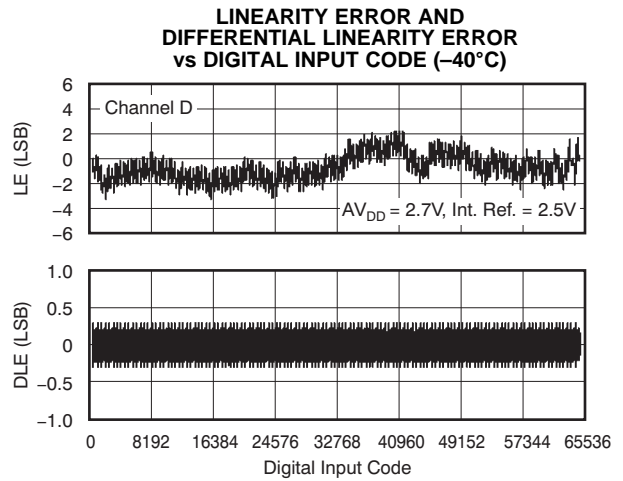

Figure 77.

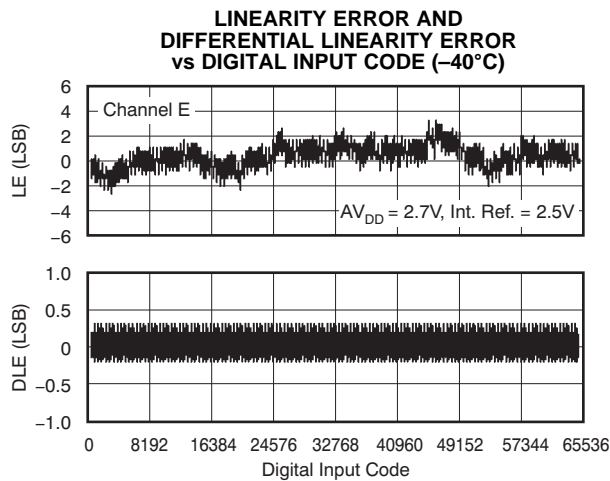

Figure 78.

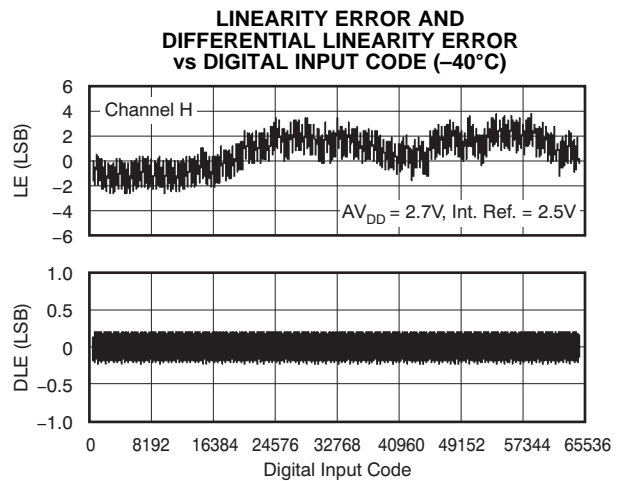

Figure 79.

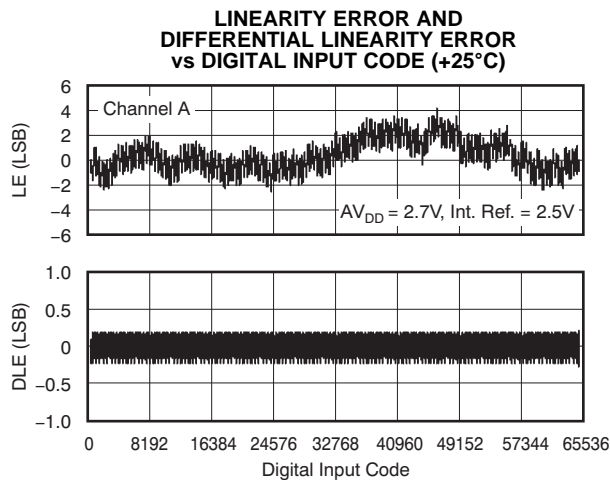

Figure 80.

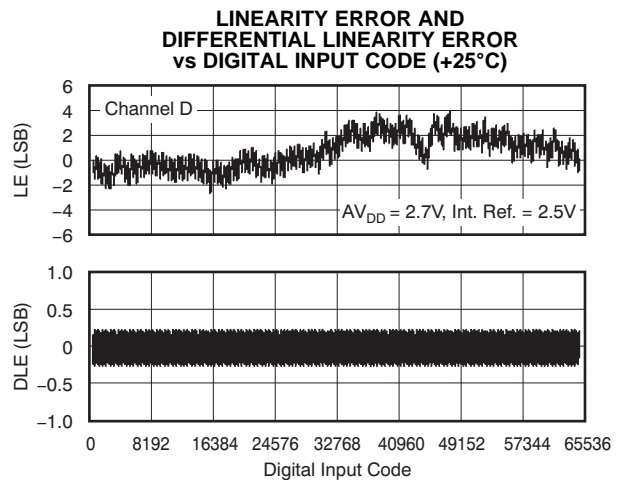

Figure 81.

TYPICAL CHARACTERISTICS: DAC at AV_{DD} = 2.7V (continued)

Channel-specific information provided as examples. At T_A = +25°C, internal reference used, and DAC output not loaded, all DAC codes in straight binary data format, unless otherwise noted

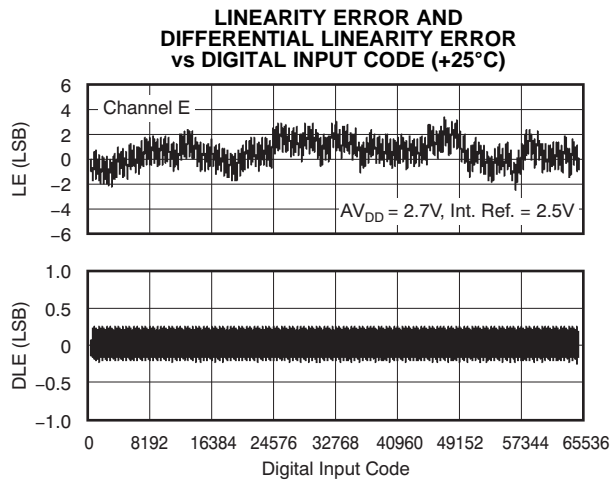

Figure 82.

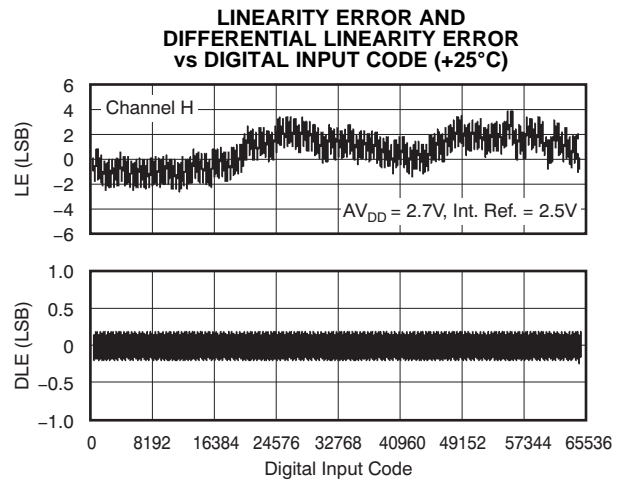

Figure 83.

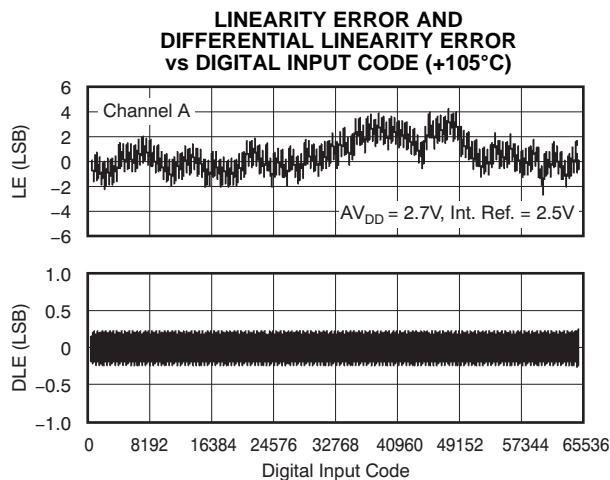

Figure 84.

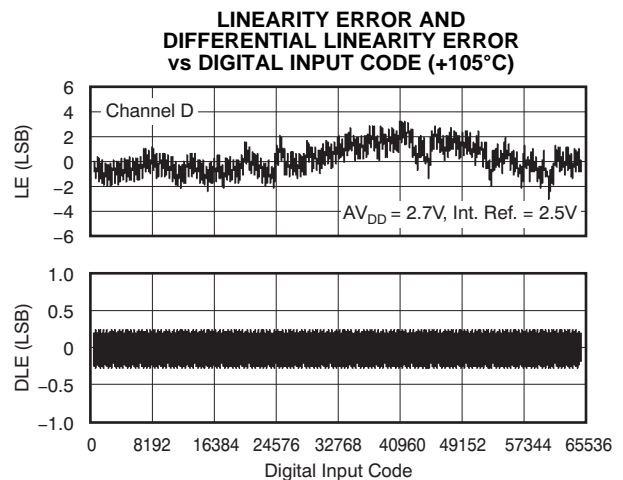

Figure 85.

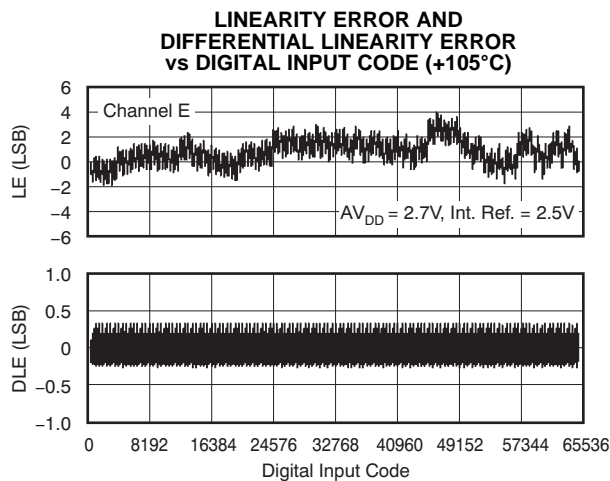

Figure 86.

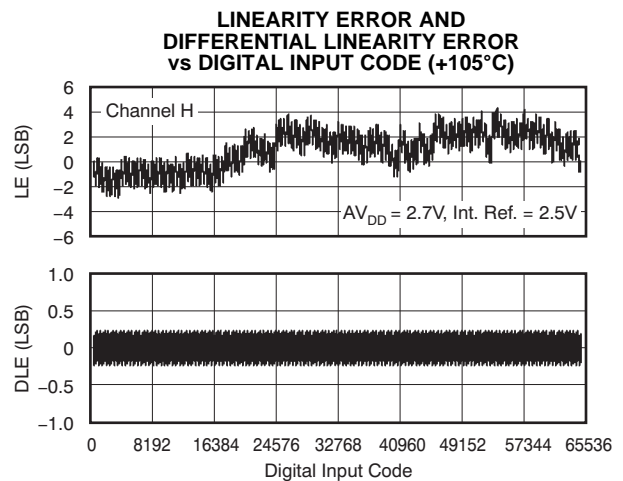

Figure 87.

TYPICAL CHARACTERISTICS: DAC at AV_{DD} = 2.7V (continued)

Channel-specific information provided as examples. At T_A = +25°C, internal reference used, and DAC output not loaded, all DAC codes in straight binary data format, unless otherwise noted

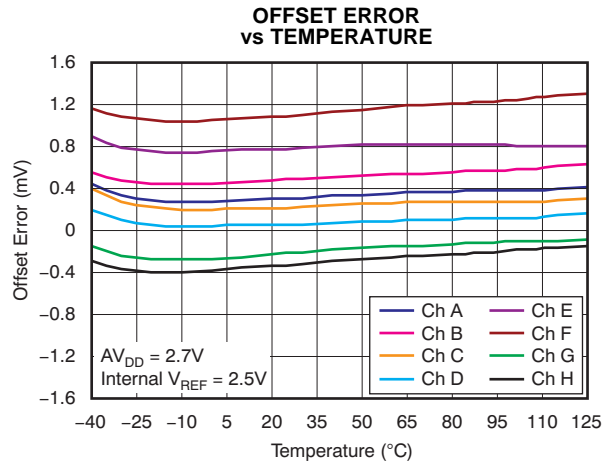

Figure 88.

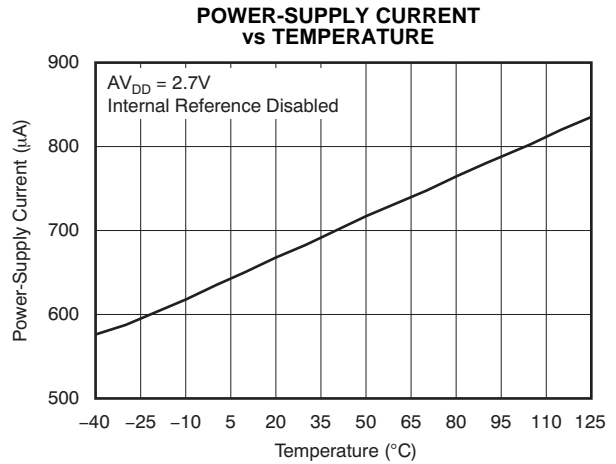

Figure 89.

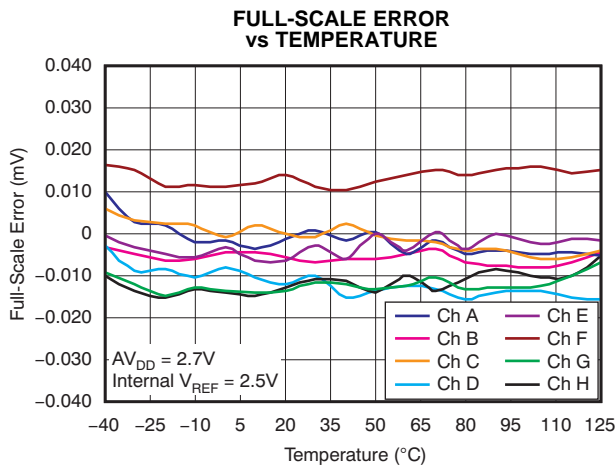

Figure 90.

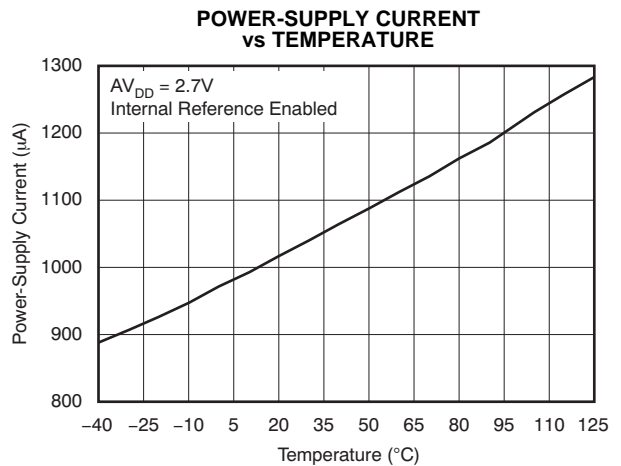

Figure 91.

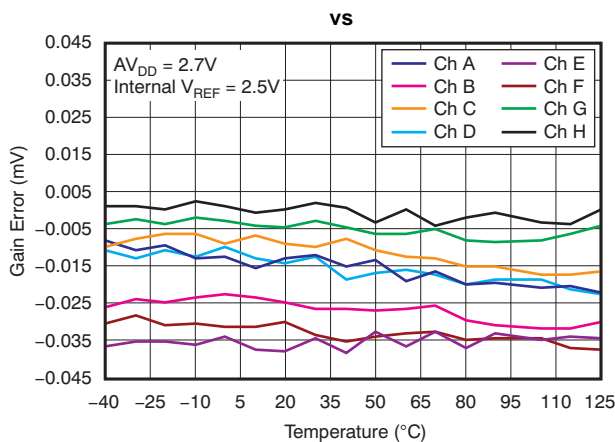

Figure 92.

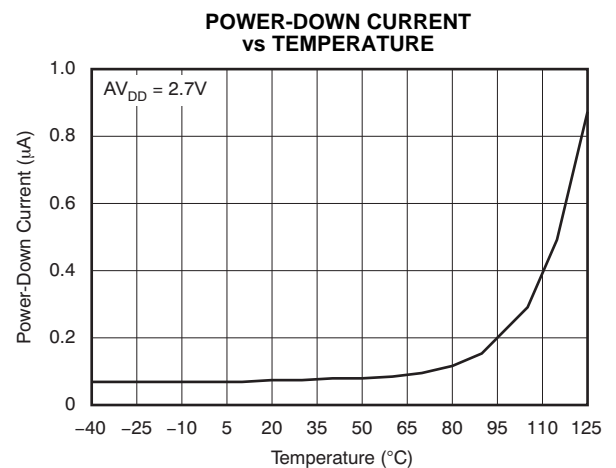

Figure 93.

TYPICAL CHARACTERISTICS: DAC at AV_{DD} = 2.7V (continued)

Channel-specific information provided as examples. At T_A = +25°C, internal reference used, and DAC output not loaded, all DAC codes in straight binary data format, unless otherwise noted

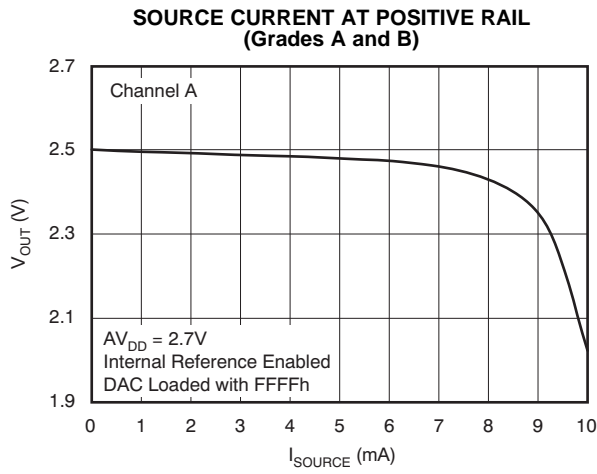

Figure 94.

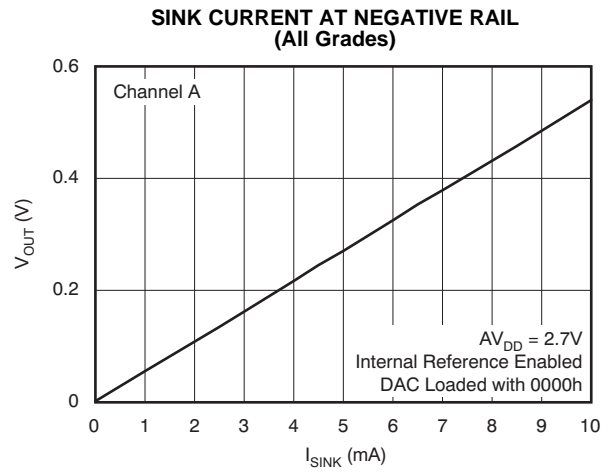

Figure 95.

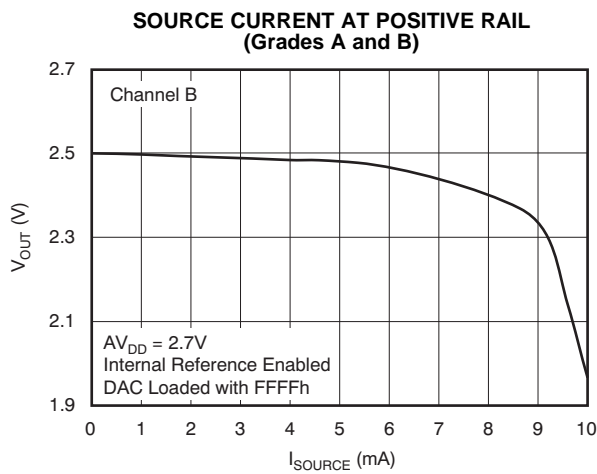

Figure 96.

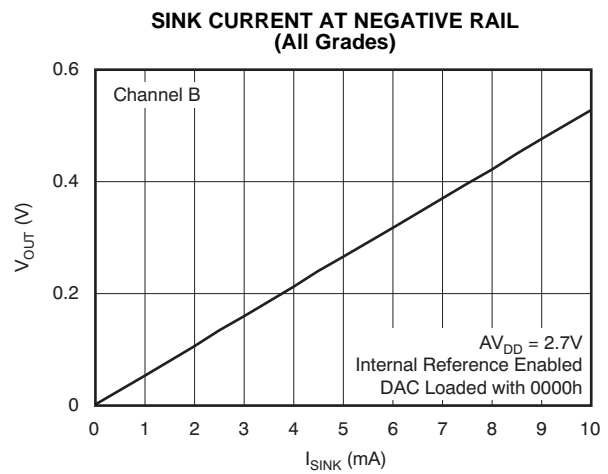

Figure 97.

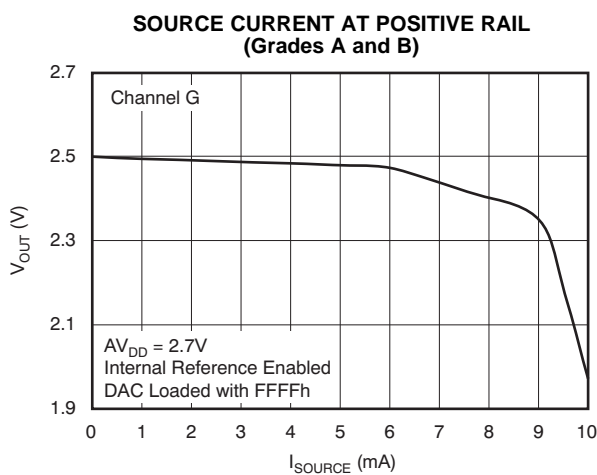

Figure 98.

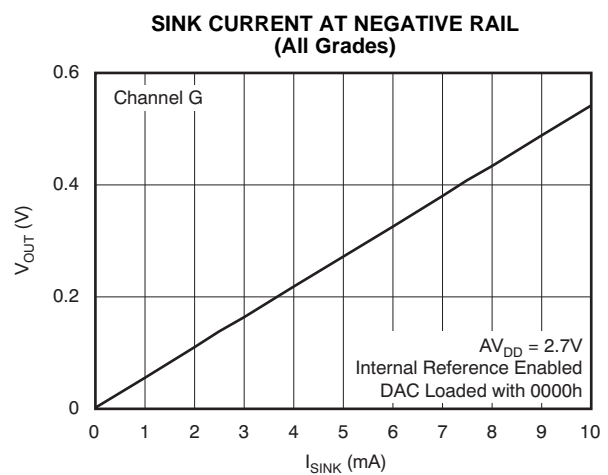

Figure 99.

TYPICAL CHARACTERISTICS: DAC at AV_{DD} = 2.7V (continued)

Channel-specific information provided as examples. At T_A = +25°C, internal reference used, and DAC output not loaded, all DAC codes in straight binary data format, unless otherwise noted

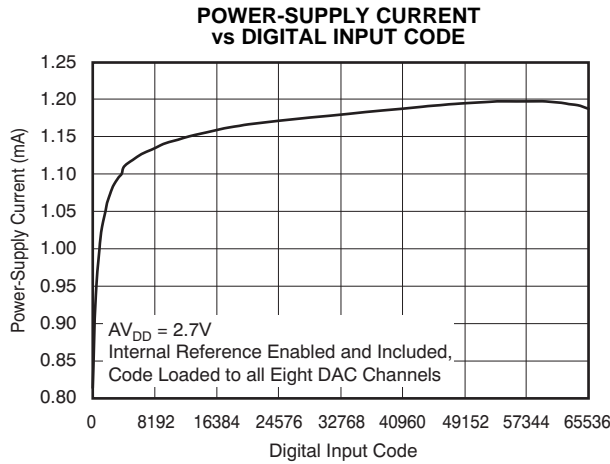

Figure 100.

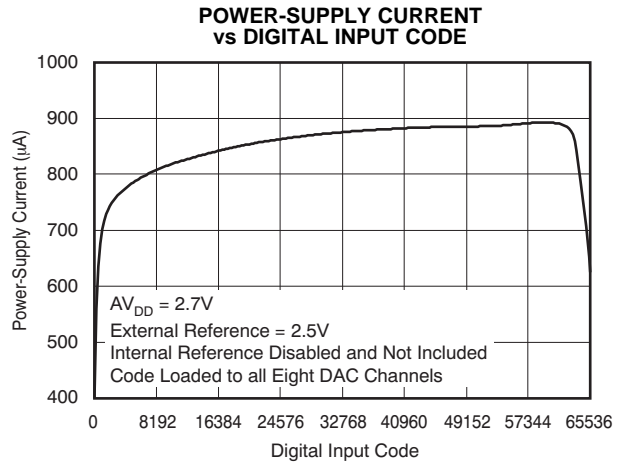

Figure 101.

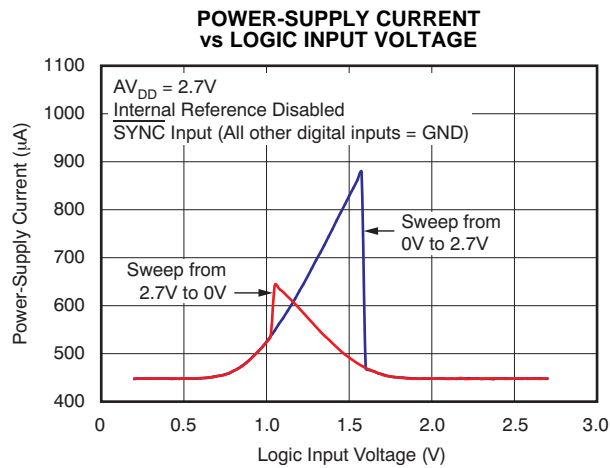

Figure 102.

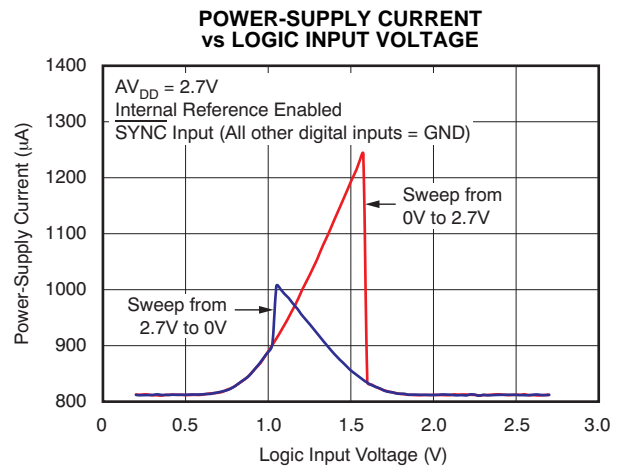

Figure 103.

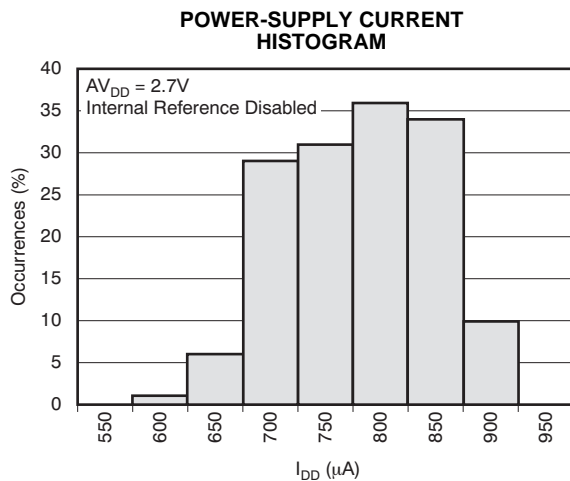

Figure 104.

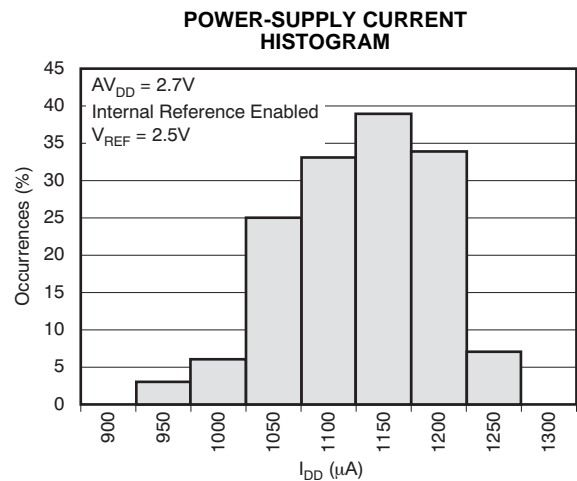
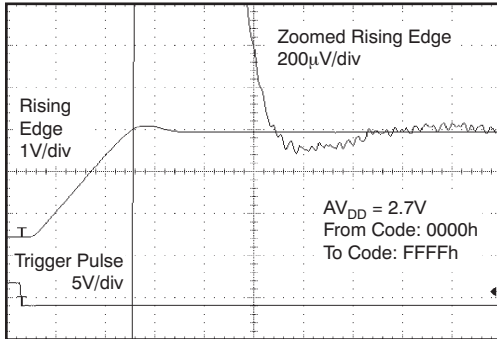

Figure 105.

TYPICAL CHARACTERISTICS: DAC at $V_{DD} = 2.7V$ (continued)

Channel-specific information provided as examples. At $T_A = +25^\circ C$, internal reference used, and DAC output not loaded, all DAC codes in straight binary data format, unless otherwise noted

**FULL-SCALE SETTling TIME:
2.7V RISING EDGE**



Time (2µs/div)

Figure 106.

**FULL-SCALE SETTling TIME:
2.7V FALLING EDGE**

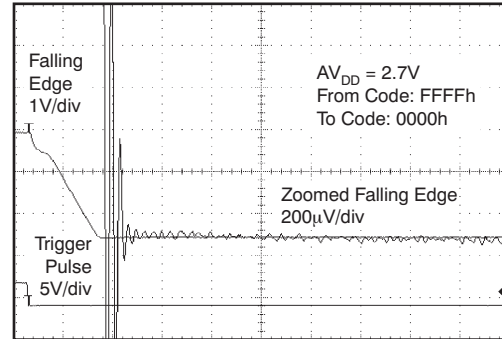

Time (2µs/div)

Figure 107.

**HALF-SCALE SETTling TIME:
2.7V RISING EDGE**

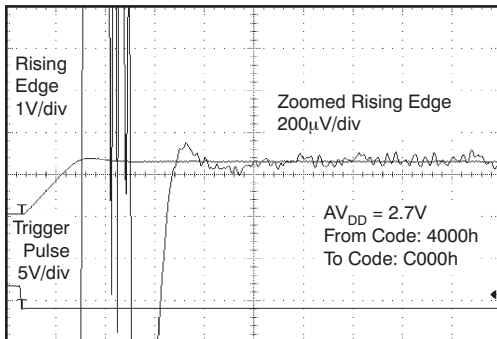

Time (2µs/div)

Figure 108.

**HALF-SCALE SETTling TIME:
2.7V FALLING EDGE**

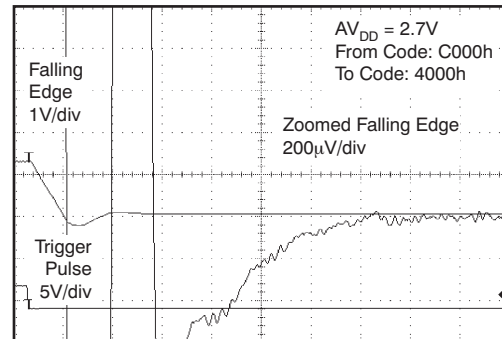

Time (2µs/div)

Figure 109.

**CLOCK FEEDTHROUGH
2.7V, 2MHz, MIDSCALE**

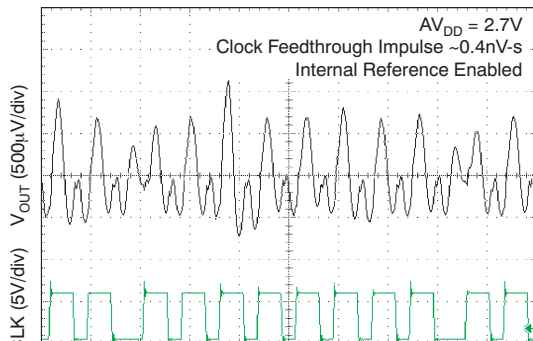

Time (1µs/div)

Figure 110.

**POWER-ON GLITCH
RESET TO ZERO SCALE**

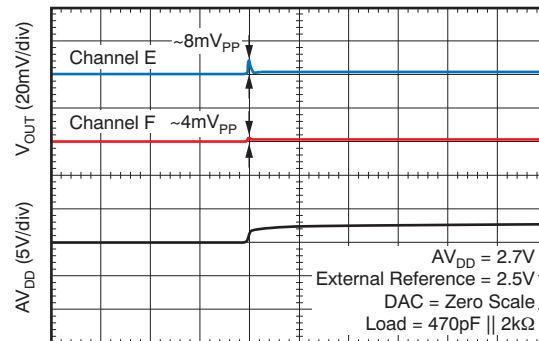

Time (4ms/div)

Figure 111.

TYPICAL CHARACTERISTICS: DAC at AV_{DD} = 2.7V (continued)

Channel-specific information provided as examples. At T_A = +25°C, internal reference used, and DAC output not loaded, all DAC codes in straight binary data format, unless otherwise noted

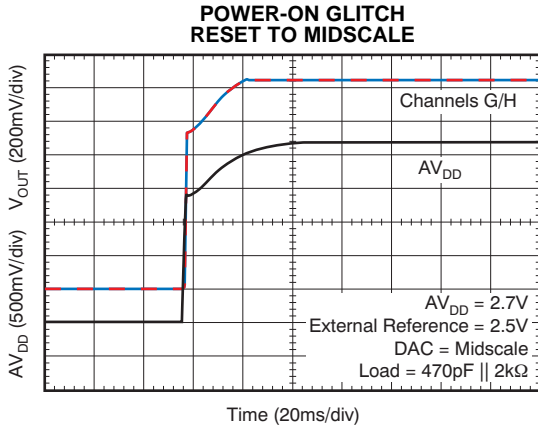

Figure 112.

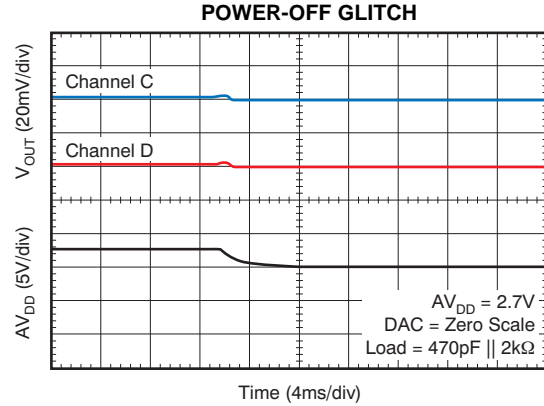

Figure 113.

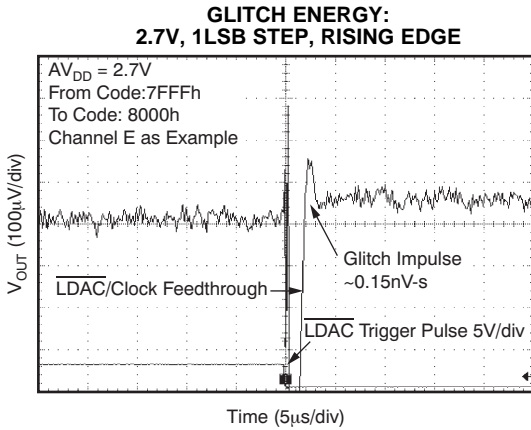

Figure 114.

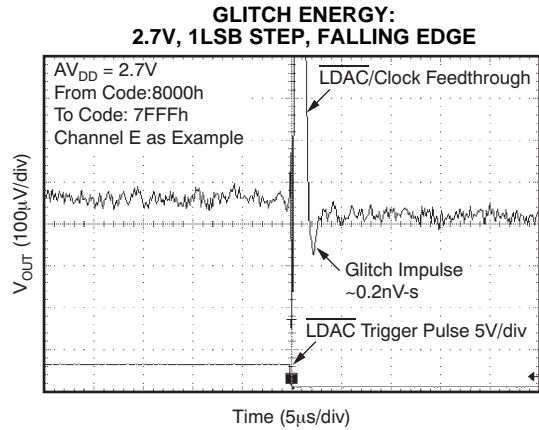

Figure 115.

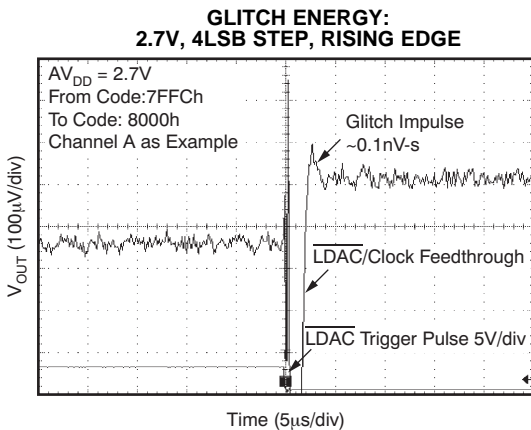

Figure 116.

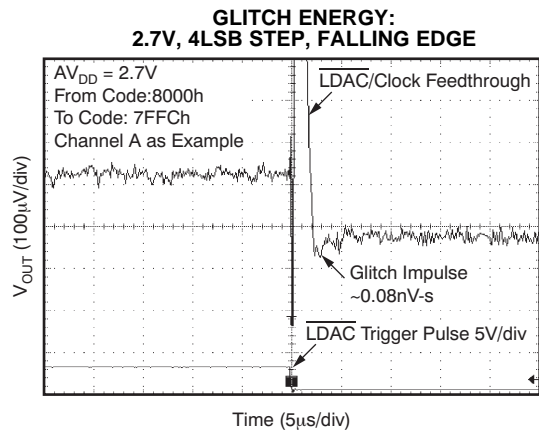

Figure 117.

TYPICAL CHARACTERISTICS: DAC at AV_{DD} = 2.7V (continued)

Channel-specific information provided as examples. At T_A = +25°C, internal reference used, and DAC output not loaded, all DAC codes in straight binary data format, unless otherwise noted

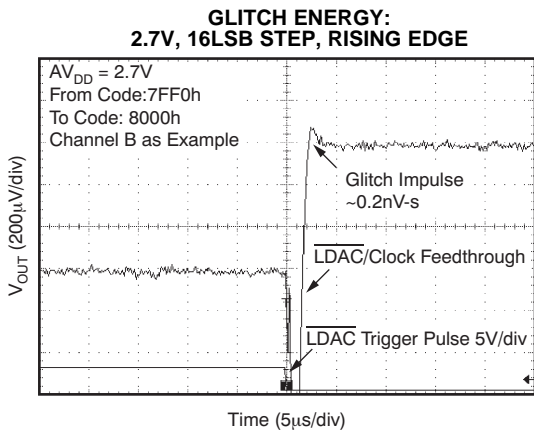

Figure 118.

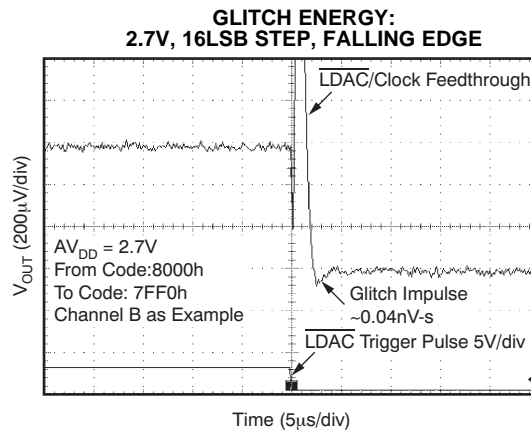

Figure 119.

THEORY OF OPERATION

DIGITAL-TO-ANALOG CONVERTER (DAC)

The DAC7568, DAC8168, and DAC8568 architecture consists of eight string DACs each followed by an output buffer amplifier. The devices include an internal 2.5V reference with 2ppm/°C temperature drift performance, and offer either 5V or 2.5V full scale output voltage. Figure 120 shows a principal block diagram of the DAC architecture.

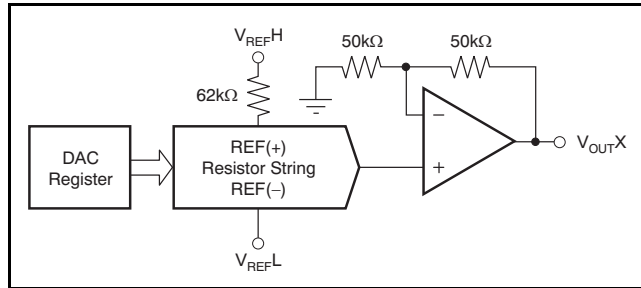

Figure 120. Device Architecture

The input coding to the DAC7568, DAC8168, and DAC8568 is straight binary, so the ideal output voltage is given by Equation 1:

$$V_{OUT} = \left[\frac{D_{IN}}{2^n} \right] \times V_{REF} \times \text{Gain} \quad (1)$$

Where:

D_{IN} = decimal equivalent of the binary code that is loaded to the DAC register. It can range from 0 to 4095 for DAC7568 (12 bit), 0 to 16,383 for DAC8168 (14 bit), and 0 to 65535 for DAC8568 (16 bit).

n = resolution in bits; either 12 (DAC7568), 14 (DAC8168) or 16 (DAC8568)

Gain = 1 for A/B grades or 2 for C/D grades.

RESISTOR STRING

The resistor string section is shown in Figure 121. It is simply a string of resistors, each of value R . The code loaded into the DAC register determines at which node on the string the voltage is tapped off by closing one of the switches connecting the string to the amplifier. It is monotonic because it is a string of resistors.

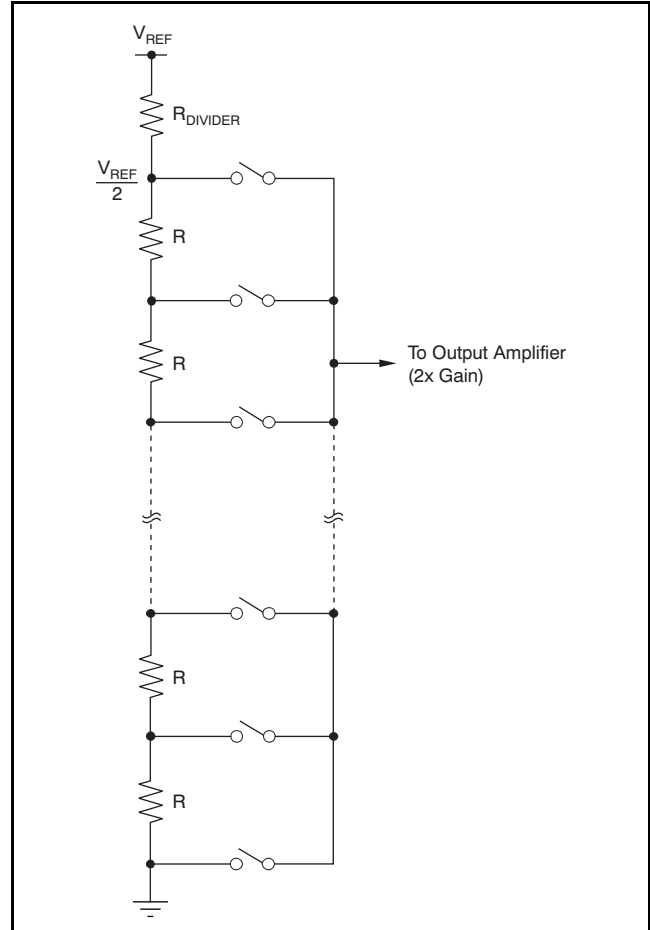

Figure 121. Resistor String

OUTPUT AMPLIFIER

The output buffer amplifier is capable of generating rail-to-rail voltages on its output, giving a maximum output range of 0V to AV_{DD} . It is capable of driving a load of 2kΩ in parallel with 3000pF to GND. The source and sink capabilities of the output amplifier can be seen in the Typical Characteristics. The typical slew rate is 0.75V/μs, with a typical full-scale settling time of 5μs with the output unloaded.

INTERNAL REFERENCE

The DAC7568, DAC8168, and DAC8568 include a 2.5V internal reference that is disabled by default. The internal reference is externally available at the V_{REFIN}/V_{REFOUT} pin. A minimum 100nF capacitor is recommended between the reference output and GND for noise filtering.

The internal reference of the DAC7568, DAC8168, and DAC8568 is a bipolar, transistor-based, precision bandgap voltage reference. Figure 122 shows the basic bandgap topology. Transistors Q_1 and Q_2 are biased such that the current density of Q_1 is greater than that of Q_2 . The difference of the two base-emitter voltages ($V_{BE1} - V_{BE2}$) has a positive temperature coefficient and is forced across resistor R_1 . This voltage is gained up and added to the base-emitter voltage of Q_2 , which has a negative temperature coefficient. The resulting output voltage is virtually independent of temperature. The short-circuit current is limited by design to approximately 100mA.

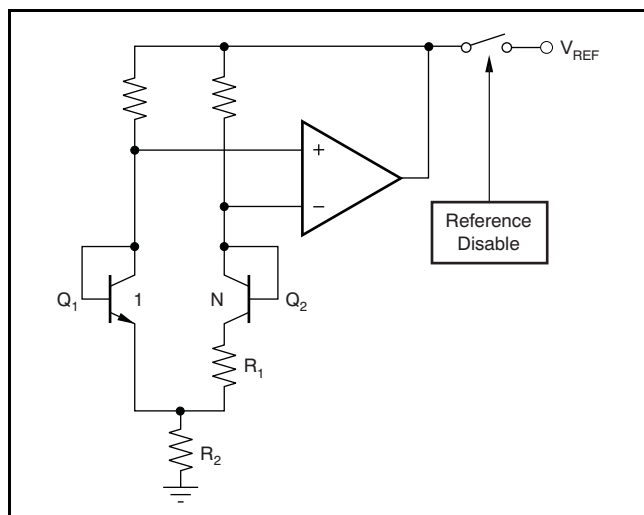

Figure 122. Bandgap Reference Simplified Schematic

Enable/Disable Internal Reference

The internal reference in the DAC7568, DAC8168, and DAC8568 is disabled by default for debugging, evaluation purposes, or when using an external reference. The internal reference can be powered up and powered down using a serial command that requires a 32-bit write sequence (see the [Serial Interface](#) section), as shown in Table 1 and Table 3. During the time that the internal reference is disabled, the DAC functions normally using an external reference. At this point, the internal reference is disconnected from the V_{REFIN}/V_{REFOUT} pin (3-state output). Do not attempt to drive the V_{REFIN}/V_{REFOUT} pin externally and internally at the same time indefinitely.

There are two modes that allow communication with the internal reference: Static and Flexible. In Flexible mode, DB19 must be set to '1'.

Static Mode (see Table 1 and Table 2)

Enabling Internal Reference:

To enable the internal reference, write the 32-bit serial command shown in Table 1. When performing a power cycle to reset the device, the internal reference is switched off (default mode). In the default mode, the internal reference is powered down until a valid write sequence is applied to power up the internal reference. If the internal reference is powered up, it automatically powers down when all DACs power down in any of the power-down modes (see the [Power Down Modes](#) section). The internal reference automatically powers up when any DAC is powered up.

Disabling Internal Reference:

To disable the internal reference, write the 32-bit serial command shown in Table 2. When performing a power cycle to reset the device, the internal reference is put back into its default mode and switched off (default mode).

Table 1. Write Sequence for Enabling Internal Reference (Static Mode)
(Internal Reference Powered On—0800001h)

DB31	DB27			DB23			DB19								DB4				DB0												
0	X	X	X	C3	C2	C1	C0	A3	A2	A1	A0	D15	D14	D13	D12	D11	D10	D9	D8	D7	D6	D5	D4	D3	D2	D1	D0	F3	F2	F1	F0
0	X	X	X	1	0	0	0	X	X	X	X	X	X	X	X	X	X	X	X	X	X	X	X	X	X	X	X	X	X	X	1

-- Prefix Bits -- | - Control Bits - | Address Bits | ----- Data Bits ----- | Feature Bits |

Table 2. Write Sequence for Disabling Internal Reference (Static Mode)
(Internal Reference Powered On—0800000h)

DB31	DB27			DB23			DB19								DB4				DB0												
0	X	X	X	C3	C2	C1	C0	A3	A2	A1	A0	D15	D14	D13	D12	D11	D10	D9	D8	D7	D6	D5	D4	D3	D2	D1	D0	F3	F2	F1	F0
0	X	X	X	1	0	0	0	X	X	X	X	X	X	X	X	X	X	X	X	X	X	X	X	X	X	X	X	X	X	0	

-- Prefix Bits -- | - Control Bits - | Address Bits | ----- Data Bits ----- | Feature Bits |

Flexible Mode (see Table 3, Table 4, and Table 5)

Enabling Internal Reference:

Method 1) To enable the internal reference, write the 32-bit serial command shown in Table 3. When performing a power cycle to reset the device, the internal reference is switched off (default mode). In the default mode, the internal reference is powered down until a valid write sequence is applied to power up the internal reference. If the internal reference is powered up, it automatically powers down when all DACs power down in any of the power-down modes (see the *Power Down Modes* section). The internal reference powers up automatically when any DAC is powered up.

Method 2) To always enable the internal reference, write the 32-bit serial command shown in Table 4. When the internal reference is always enabled, any power-down command to the DAC channels does not change the internal reference operating mode. When

performing a power cycle to reset the device, the internal reference is switched off (default mode). In the default mode, the internal reference is powered down until a valid write sequence is applied to power up the internal reference. When the internal reference is powered up, it remains powered up, regardless of the state of the DACs.

Disabling Internal Reference:

To disable the internal reference, write the 32-bit serial command shown in Table 5. When performing a power cycle to reset the device, the internal reference is switched off (default mode).

When the internal reference is operated in Flexible mode, Static mode is disabled and does not work. To switch from Flexible mode to Static mode, use the command shown in Table 6.

**Table 3. Write Sequence for Enabling Internal Reference (Flexible Mode)
 (Internal Reference Powered On—09080000h)**

DB31				DB27				DB23				DB19				DB4				DB0											
0	X	X	X	C3	C2	C1	C0	A3	A2	A1	A0	D15	D14	D13	D12	D11	D10	D9	D8	D7	D6	D5	D4	D3	D2	D1	D0	F3	F2	F1	F0
0	X	X	X	1	0	0	1	X	X	X	X	1	0	0	X	X	X	X	X	X	X	X	X	X	X	X	X	X	X	X	X
-- Prefix Bits --				- Control Bits -				Address Bits				----- Data Bits -----																Feature Bits			

**Table 4. Write Sequence for Enabling Internal Reference (Flexible Mode)
 (Internal Reference Always Powered On—090A0000h)**

DB31				DB27				DB23				DB19				DB4				DB0											
0	X	X	X	C3	C2	C1	C0	A3	A2	A1	A0	D15	D14	D13	D12	D11	D10	D9	D8	D7	D6	D5	D4	D3	D2	D1	D0	F3	F2	F1	F0
0	X	X	X	1	0	0	1	X	X	X	X	1	0	1	X	X	X	X	X	X	X	X	X	X	X	X	X	X	X	X	X
-- Prefix Bits --				- Control Bits -				Address Bits				----- Data Bits -----																Feature Bits			

**Table 5. Write Sequence for Disabling Internal Reference (Flexible Mode)
 (Internal Reference Always Powered Down—090C0000h)**

DB31				DB27				DB23				DB19				DB4				DB0											
0	X	X	X	C3	C2	C1	C0	A3	A2	A1	A0	D15	D14	D13	D12	D11	D10	D9	D8	D7	D6	D5	D4	D3	D2	D1	D0	F3	F2	F1	F0
0	X	X	X	1	0	0	1	X	X	X	X	1	1	0	X	X	X	X	X	X	X	X	X	X	X	X	X	X	X	X	X
-- Prefix Bits --				- Control Bits -				Address Bits				----- Data Bits -----																Feature Bits			

**Table 6. Write Sequence for Switching from Flexible Mode to Static Mode for Internal Reference
 (Internal Reference Always Powered Down—09000000h)**

DB31				DB27				DB23				DB19				DB4				DB0											
0	X	X	X	C3	C2	C1	C0	A3	A2	A1	A0	D15	D14	D13	D12	D11	D10	D9	D8	D7	D6	D5	D4	D3	D2	D1	D0	F3	F2	F1	F0
0	X	X	X	1	0	0	1	X	X	X	X	0	0	0	X	X	X	X	X	X	X	X	X	X	X	X	X	X	X	X	X
-- Prefix Bits --				- Control Bits -				Address Bits				----- Data Bits -----																Feature Bits			

SERIAL INTERFACE

The DAC7568, DAC8168, and DAC8568 have a 3-wire serial interface ($\overline{\text{SYNC}}$, SCLK, and D_{IN} ; see the [Pin Configurations](#)) compatible with SPI, QSPI, and Microwire interface standards, as well as most DSPs. See the Serial Write Operation timing diagram ([Figure 1](#)) for an example of a typical write sequence.

The DAC7568, DAC8168, and DAC8568 input shift register is 32-bits wide, consisting of four prefix bits (DB31 to DB28), four control bits (DB27 to DB24), 16 data bits (DB23 to DB4), and four feature bits. The 16 data bits comprise the 16-, 14-, or 12-bit input code. When writing to the DAC register (data transfer), bits DB0 to DB3 (for 16-bit operation), DB0 to DB5 (for 14-bit operation), and DB0 to DB7 (for 12-bit operation) are ignored by the DAC and should be treated as *don't care* bits (see [Table 7](#) to [Table 9](#)). All 32 bits of data are loaded into the DAC under the control of the serial clock input, SCLK.

DB31 (MSB) is the first bit that is loaded into the DAC shift register and must be always set to '0'. It is followed by the rest of the 32-bit word pattern, left-aligned. This configuration means that the first 32 bits of data are latched into the shift register and any further clocking of data is ignored. When the DAC registers are being written to, the DAC7568, DAC8168, and DAC8568 receive all 32 bits of data, ignore DB31 to DB28, and decode the second set of four bits (DB27 to DB24) in order to determine the DAC operating/control mode (see [Table 10](#)). Bits DB23 to DB20 are used to address selected DAC channels. The next 16/14/12 bits of data that follow are decoded by the DAC to determine the equivalent analog output. The last four data bits (DB0 to DB3 for DAC8568), last data six bits (DB0 to DB5 for DAC8168), or last eight data bits (DB0 to DB7 for DAC7568) are ignored in this case. For more details on these and other commands (such as write to LDAC register, power down DACs, etc.), see [Table 10](#).

The data format is straight binary with all '0's corresponding to 0V output and all '1's corresponding to full-scale output. For all documentation purposes, the data format and representation used here is a true 16-bit pattern (that is, FFFFh for data word for full-scale) that the DAC7568, DAC8168, and DAC8568 require.

The write sequence begins by bringing the $\overline{\text{SYNC}}$ line low. Data from the D_{IN} line are clocked into the 32-bit shift register on each falling edge of SCLK. The serial clock frequency can be as high as 50MHz, making the DAC7568, DAC8168, and DAC8568 compatible with high-speed DSPs. On the 32nd falling edge of the serial clock, the last data bit is clocked into the shift register and the shift register locks. Further clocking does not change the shift register data. After receiving the 32nd falling clock edge, the DAC7568, DAC8168, and DAC8568 decode the four control bits and four address bits and 16/14/12 data bits to perform the required function, without waiting for a $\overline{\text{SYNC}}$ rising edge. A new write sequence starts at the next falling edge of $\overline{\text{SYNC}}$. A rising edge of $\overline{\text{SYNC}}$ before the 31st-bit sequence is complete resets the SPI interface; no data transfer occurs. After the 32nd falling edge of SCLK is received, the $\overline{\text{SYNC}}$ line may be kept low or brought high. In either case, the minimum delay time from the 32nd falling SCLK edge to the next falling $\overline{\text{SYNC}}$ edge must be met in order to properly begin the next cycle; see the Serial Write Operation timing diagram ([Figure 1](#)). To assure the lowest power consumption of the device, care should be taken that the levels are as close to each rail as possible. Refer to the 5.5V, 3.6V, and 2.7V Typical Characteristics sections for the *Power-Supply Current vs Logic Input Voltage* graphs ([Figure 43](#), [Figure 44](#), [Figure 70](#), [Figure 72](#), [Figure 102](#), and [Figure 103](#)).

INPUT SHIFT REGISTER

The input shift register (SR) of the DAC7568, DAC8168, and DAC8568 is 32 bits wide (as shown in Table 7, Table 8, and Table 9, respectively), and consists of four Prefix bits (DB31 to DB28), four control bits (DB27 to DB24), 16 data bits (DB23 to

DB4), and four additional feature bits. The 16 data bits comprise the 16-, 14-, or 12-bit input code.

The DAC7568, DAC8168, and DAC8568 support a number of different load commands. The load commands are summarized in Table 10.

Table 7. DAC8568 Data Input Register Format

DB31				DB27				DB23				DB19				DB4				DB0											
0	X	X	X	C3	C2	C1	C0	A3	A2	A1	A0	D15	D14	D13	D12	D11	D10	D9	D8	D7	D6	D5	D4	D3	D2	D1	D0	F3	F2	F1	F0
-- Prefix Bits --				- Control Bits -				Address Bits				----- Data Bits -----																Feature Bits			

Table 8. DAC8168 Data Input Register Format

DB31				DB27				DB23				DB19				DB4				DB0											
0	X	X	X	C3	C2	C1	C0	A3	A2	A1	A0	D13	D12	D11	D10	D9	D8	D7	D6	D5	D4	D3	D2	D1	D0	X	X	F3	F2	F1	F0
-- Prefix Bits --				- Control Bits -				Address Bits				----- Data Bits -----																Feature Bits			

Table 9. DAC7568 Data Input Register Format

DB31				DB27				DB23				DB19				DB4				DB0											
0	X	X	X	C3	C2	C1	C0	A3	A2	A1	A0	D11	D10	D9	D8	D7	D6	D5	D4	D3	D2	D1	D0	X	X	X	X	F3	F2	F1	F0
-- Prefix Bits --				- Control Bits -				Address Bits				----- Data Bits -----																Feature Bits			

Table 10. Control Matrix for the DAC7568, DAC8168, and DAC8568

DB31	DB30-DB28	DB27	DB26	DB25	DB24	DB23	DB22	DB21	DB20	DB19	DB18	DB17	DB16-DB10	DB9	DB8	DB7	DB6	DB5	DB4	DB3	DB2	DB1	DB0	DESCRIPTION
0	Don't Care	C3	C2	C1	C0	A3	A2	A1	A0	D16	D15	D14	D13-D7	D6	D5	D4	D3	D2	D1	F3	F2	F1	F0	GENERAL DATA FORMAT FOR 16-BIT DAC8568
0	Don't Care	C3	C2	C1	C0	A3	A2	A1	A0	D14	D13	D12	D11-D5	D4	D3	D2	D1	X	X	F3	F2	F1	F0	GENERAL DATA FORMAT FOR 14-BIT DAC8168
0	Don't Care	C3	C2	C1	C0	A3	A2	A1	A0	D12	D11	D10	D9-D3	D2	D1	X	X	X	X	F3	F2	F1	F0	GENERAL DATA FORMAT FOR 12-BIT DAC7568
1	X	X	X	X	X	X	X	X	X	X	X	X	X	X	X	X	X	X	X	X	X	X	X	Reserved Bit - Not valid; device does not perform to specified conditions
Write to Selected DAC Input Register																								
0	X	0	0	0	0	0	0	0	0					Data						X	X	X	X	Write to input register - DAC Channel A
0	X	0	0	0	0	0	0	0	1					Data						X	X	X	X	Write to input register - DAC Channel B
0	X	0	0	0	0	0	0	1	0					Data						X	X	X	X	Write to input register - DAC Channel C
0	X	0	0	0	0	0	0	1	1					Data						X	X	X	X	Write to input register - DAC Channel D
0	X	0	0	0	0	0	1	0	0					Data						X	X	X	X	Write to input register - DAC Channel E
0	X	0	0	0	0	0	1	0	1					Data						X	X	X	X	Write to input register - DAC Channel F
0	X	0	0	0	0	0	1	1	0					Data						X	X	X	X	Write to input register - DAC Channel G
0	X	0	0	0	0	0	1	1	1					Data						X	X	X	X	Write to input register - DAC Channel H
0	X	0	0	0	0	1	X	X	X					X						X	X	X	X	Invalid code - No DAC channel is updated
0	X	0	0	0	0	1	1	1	1					Data						X	X	X	X	Broadcast mode - Write to all DAC channels
Update Selected DAC Registers																								
0	X	0	0	0	1	0	0	0	0					Data						X	X	X	X	Update DAC register - DAC Channel A
0	X	0	0	0	1	0	0	0	1					Data						X	X	X	X	Update DAC register - DAC Channel B
0	X	0	0	0	1	0	0	1	0					Data						X	X	X	X	Update DAC register - DAC Channel C
0	X	0	0	0	1	0	0	1	1					Data						X	X	X	X	Update DAC register - DAC Channel D
0	X	0	0	0	1	0	1	0	0					Data						X	X	X	X	Update DAC register - DAC Channel E
0	X	0	0	0	1	0	1	0	1					Data						X	X	X	X	Update DAC register - DAC Channel F
0	X	0	0	0	1	0	1	1	0					Data						X	X	X	X	Update DAC register - DAC Channel G
0	X	0	0	0	1	0	1	1	1					Data						X	X	X	X	Update DAC register - DAC Channel H
0	X	0	0	0	1	1	X	X	X					X						X	X	X	X	Invalid code - No DAC channel is updated
0	X	0	0	0	1	1	1	1	1					Data						X	X	X	X	Broadcast mode - Update all DAC registers
Write to Clear Code Register																								
0	X	0	1	0	1	X	X	X	X	X	X	X	X	X	X	X	X	X	X	X	X	0	0	Write to clear code register; clear to zero scale
0	X	0	1	0	1	X	X	X	X	X	X	X	X	X	X	X	X	X	X	X	X	0	1	Write to clear code register; clear to midscale
0	X	0	1	0	1	X	X	X	X	X	X	X	X	X	X	X	X	X	X	X	X	1	0	Write to clear code register; clear to full-scale
0	X	0	1	0	1	X	X	X	X	X	X	X	X	X	X	X	X	X	X	X	X	1	1	Write to clear code register; ignore CLR pin
Write to LDAC Register																								
0	X	0	1	1	0	X	X	X	X	X	X	X	X	X	X	DAC H	DAC G	DAC F	DAC E	DAC D	DAC C	DAC B	DAC A	Write to LDAC register. Default setting of these bits is '0'. If bit is set to '1', the LDAC pin is overridden. See the LDAC Functionality section for details.
Software Reset																								
0	X	0	1	1	1	X	X	X	X	X	X	X	X	X	X	X	X	X	X	X	X	X	X	Software reset (power-on reset)

Table 10. Control Matrix for the DAC7568, DAC8168, and DAC8568 (continued)

DB31	DB30-DB28	DB27	DB26	DB25	DB24	DB23	DB22	DB21	DB20	DB19	DB18	DB17	DB16-DB10	DB9	DB8	DB7	DB6	DB5	DB4	DB3	DB2	DB1	DB0	DESCRIPTION				
0	Don't Care	C3	C2	C1	C0	A3	A2	A1	A0	D16	D15	D14	D13-D7	D6	D5	D4	D3	D2	D1	F3	F2	F1	F0	GENERAL DATA FORMAT FOR 16-BIT DAC8568				
0	Don't Care	C3	C2	C1	C0	A3	A2	A1	A0	D14	D13	D12	D11-D5	D4	D3	D2	D1	X	X	F3	F2	F1	F0	GENERAL DATA FORMAT FOR 14-BIT DAC8168				
0	Don't Care	C3	C2	C1	C0	A3	A2	A1	A0	D12	D11	D10	D9-D3	D2	D1	X	X	X	X	F3	F2	F1	F0	GENERAL DATA FORMAT FOR 12-BIT DAC7568				
Write to Selected DAC Input Register and Update All DAC Registers																												
0	X	0	0	1	0	0	0	0	0	Data										X	X	X	X	Write to DAC input register Ch A and update all DAC registers (SW LDAC)				
0	X	0	0	1	0	0	0	0	1	Data										X	X	X	X	Write to DAC Input Register Ch B and update all DAC registers (SW LDAC)				
0	X	0	0	1	0	0	0	1	0	Data										X	X	X	X	Write to DAC Input Register Ch C and update all DAC registers (SW LDAC)				
0	X	0	0	1	0	0	0	1	1	Data										X	X	X	X	Write to DAC Input Register Ch D and update all DAC registers (SW LDAC)				
0	X	0	0	1	0	0	1	0	0	Data										X	X	X	X	Write to DAC Input Register Ch E and update all DAC registers (SW LDAC)				
0	X	0	0	1	0	0	1	0	1	Data										X	X	X	X	Write to DAC Input Register Ch F and update all DAC registers (SW LDAC)				
0	X	0	0	1	0	0	1	1	1	Data										X	X	X	X	Write to DAC Input Register Ch G and update all DAC registers (SW LDAC)				
0	X	0	0	1	0	1	X	X	X	Data										X	X	X	X	Invalid code - No DAC Channel is updated				
0	X	0	0	1	0	1	1	1	1	Data										X	X	X	X	Broadcast mode - Write to all DAC input registers and update all DAC registers (SW LDAC)				
Write to Selected DAC Input Register and Update Respective DAC Register																												
0	X	0	0	1	1	0	0	0	0	Data										X	X	X	X	Write to DAC input register Ch A and update DAC register Ch A				
0	X	0	0	1	1	0	0	0	1	Data										X	X	X	X	Write to DAC Input Register Ch B and update DAC register Ch B				
0	X	0	0	1	1	0	0	1	0	Data										X	X	X	X	Write to DAC Input Register Ch C and update DAC register Ch C				
0	X	0	0	1	1	0	0	1	1	Data										X	X	X	X	Write to DAC Input Register Ch D and update DAC register Ch D				
0	X	0	0	1	1	0	1	0	0	Data										X	X	X	X	Write to DAC Input Register Ch E and update DAC register Ch E				
0	X	0	0	1	1	0	1	0	1	Data										X	X	X	X	Write to DAC Input Register Ch F and update DAC register Ch F				
0	X	0	0	1	1	0	1	1	0	Data										X	X	X	X	Write to DAC Input Register Ch G and update DAC register Ch G				
0	X	0	0	1	1	0	1	1	1	Data										X	X	X	X	Write to DAC Input Register Ch H and update DAC register Ch H				
0	X	0	0	1	1	1	X	X	X	Data										X	X	X	X	Invalid code - No DAC channel is updated				
0	X	0	0	1	1	1	1	1	1	Data										X	X	X	X	Broadcast mode - Write to all DAC input registers and update all DAC registers (SW LDAC)				

Table 10. Control Matrix for the DAC7568, DAC8168, and DAC8568 (continued)

DB31	DB30-DB28	DB27	DB26	DB25	DB24	DB23	DB22	DB21	DB20	DB19	DB18	DB17	DB16-DB10	DB9	DB8	DB7	DB6	DB5	DB4	DB3	DB2	DB1	DB0	DESCRIPTION
0	Don't Care	C3	C2	C1	C0	A3	A2	A1	A0	D16	D15	D14	D13-D7	D6	D5	D4	D3	D2	D1	F3	F2	F1	F0	GENERAL DATA FORMAT FOR 16-BIT DAC8568
0	Don't Care	C3	C2	C1	C0	A3	A2	A1	A0	D14	D13	D12	D11-D5	D4	D3	D2	D1	X	X	F3	F2	F1	F0	GENERAL DATA FORMAT FOR 14-BIT DAC8168
0	Don't Care	C3	C2	C1	C0	A3	A2	A1	A0	D12	D11	D10	D9-D3	D2	D1	X	X	X	X	F3	F2	F1	F0	GENERAL DATA FORMAT FOR 12-BIT DAC7568
Power-Down Commands																								
0	X	0	1	0	0	X	X	X	X	X	X	X	X	0	0	DAC H	DAC G	DAC F	DAC E	DAC D	DAC C	DAC B	DAC A	Power-up DAC A, B, C, D, E, F, G, H by setting respective bit to '1'
0	X	0	1	0	0	X	X	X	X	X	X	X	X	0	1	DAC H	DAC G	DAC F	DAC E	DAC D	DAC C	DAC B	DAC A	Power-down DAC A, B, C, D, E, F, G, H, 1kΩ to GND by setting respective bit to '0'
0	X	0	1	0	0	X	X	X	X	X	X	X	X	1	0	DAC H	DAC G	DAC F	DAC E	DAC D	DAC C	DAC B	DAC A	Power-down DAC A, B, C, D, E, F, G, H, 100kΩ to GND by setting respective bit to '0'
0	X	0	1	0	0	X	X	X	X	X	X	X	X	1	1	DAC H	DAC G	DAC F	DAC E	DAC D	DAC C	DAC B	DAC A	Power-down DAC A, B, C, D, E, F, G, H, High-Z to GND by setting respective bit to '0'
Internal Reference Commands																								
0	X	1	0	0	0	X	X	X	X	X	X	X	X	X	X	X	X	X	X	X	X	X	0	Power down internal reference - static mode (default), must use external reference to operate device; see Table 2
0	X	1	0	0	0	X	X	X	X	X	X	X	X	X	X	X	X	X	X	X	X	X	1	Power up internal reference - static mode; see Table 1 (NOTE: When all DACs power down, the reference powers down; when any DAC powers up, the reference powers up)
0	X	1	0	0	1	X	X	X	X	1	0	0	X	X	X	X	X	X	X	X	X	X	X	Power up internal reference - flexible mode; see Table 3 (NOTE: When all DACs power down, the reference powers down; when any DAC powers up, the reference powers up)
0	X	1	0	0	1	X	X	X	X	1	0	1	X	X	X	X	X	X	X	X	X	X	X	Power up internal reference all the time regardless of state of DACs - flexible mode; see Table 4
0	X	1	0	0	1	X	X	X	X	1	1	0	X	X	X	X	X	X	X	X	X	X	X	Power down internal reference all the time regardless of state of DACs - flexible mode; see Table 5 (NOTE: External reference must be used to operate device)
0	X	1	0	0	1	X	X	X	X	0	0	0	X	X	X	X	X	X	X	X	X	X	X	Switching internal reference mode from flexible mode to static mode
Reserved Bits																								
0	X	1	0	1	0	X	X	X	X	X	X	X	X	X	X	X	X	X	X	X	X	X	X	Reserved Bit - not valid; device does not perform to specified conditions
0	X	1	0	1	1	X	X	X	X	X	X	X	X	X	X	X	X	X	X	X	X	X	X	Reserved Bit - not valid; device does not perform to specified conditions
0	X	1	1	0	0	X	X	X	X	X	X	X	X	X	X	X	X	X	X	X	X	X	X	Reserved Bit - not valid; device does not perform to specified conditions
0	X	1	1	0	1	X	X	X	X	X	X	X	X	X	X	X	X	X	X	X	X	X	X	Reserved Bit - not valid; device does not perform to specified conditions
0	X	1	1	1	0	X	X	X	X	X	X	X	X	X	X	X	X	X	X	X	X	X	X	Reserved Bit - not valid; device does not perform to specified conditions
0	X	1	1	1	1	X	X	X	X	X	X	X	X	X	X	X	X	X	X	X	X	X	X	Reserved Bit - not valid; device does not perform to specified conditions

SYNC INTERRUPT

In a normal write sequence, the $\overline{\text{SYNC}}$ line stays low for at least 32 falling edges of SCLK and the addressed DAC register updates on the 32nd falling edge. However, if SYNC is brought high before the 31st falling edge, it acts as an interrupt to the write sequence; the shift register resets and the write sequence is discarded. Neither an update of the data buffer contents, DAC register contents, nor a change in the operating mode occurs (as shown in Figure 123).

POWER-ON RESET TO ZERO SCALE OR MIDSCALE

The DAC7568, DAC8168, and DAC8568 contain a power-on reset circuit that controls the output voltage during power-up. For device grades A and C on power-up, all DAC registers are filled with zeros and the output voltages of all DAC channels are set to zero scale. For device grades B and D all DAC registers are set to have all DAC channels power up in midscale. All DAC channels remain that way until a valid write sequence and load command are made to the respective DAC channel. The power-on reset is useful in applications where it is important to know the state of the output of each DAC while the device is in the process of powering up. No device pin should be brought high before power is applied to the device. The internal reference is powered off / down by default and remains that way until a valid reference-change command is executed.

LDAC FUNCTIONALITY

The DAC7568, DAC8168, and DAC8568 offer both a software and hardware simultaneous update and control function. The DAC double-buffered architecture has been designed so that new data can be entered for each DAC without disturbing the analog outputs.

DAC7568, DAC8168, and DAC8568 data updates can be performed either in *synchronous* or in *asynchronous* mode.

In *synchronous* mode, data are updated with the falling edge of the 32nd SCLK cycle, which follows a falling edge of $\overline{\text{SYNC}}$. For such *synchronous* updates, the LDAC pin is not required and it must be connected to GND permanently.

In *asynchronous* mode, the $\overline{\text{LDAC}}$ pin is used as a negative edge triggered timing signal for simultaneous DAC updates. Multiple single-channel updates can be done in order to set different channel buffers to desired values and then make a falling edge on LDAC pin to simultaneously update the DAC output registers. Data buffers of all channels must be loaded with desired data before an $\overline{\text{LDAC}}$ falling edge. After a high-to-low $\overline{\text{LDAC}}$ transition, all DACs are simultaneously updated with the last contents of the corresponding data buffers. If the content of a data buffer is not changed, the corresponding DAC output remains unchanged after the LDAC pin is triggered.

Alternatively, all DAC outputs can be updated simultaneously using the built-in software function of LDAC. The LDAC register offers additional flexibility and control by allowing the selection of which DAC channel(s) should be updated simultaneously when the $\overline{\text{LDAC}}$ pin is being brought low. The LDAC register is loaded with an 8-bit word (DB0 to DB7) using control bits C3, C2, C1, and C0 (see Table 10). The default value for each bit, and therefore for each DAC channel, is zero. The external LDAC pin operates in normal mode. If the LDAC register bit is set to '1', it overrides the $\overline{\text{LDAC}}$ pin (the LDAC pin is internally tied low for that particular DAC channel) and this DAC channel updates synchronously after the falling edge of the 32nd SCLK cycle. However, if the LDAC register bit is set to '0', the DAC channel is controlled by the LDAC pin.

The combination of software and hardware simultaneous update functions is particularly useful in applications when updating only selective DAC channels simultaneously, while keeping the other channels unaffected and updating those channels synchronously; see Table 10 for more information.

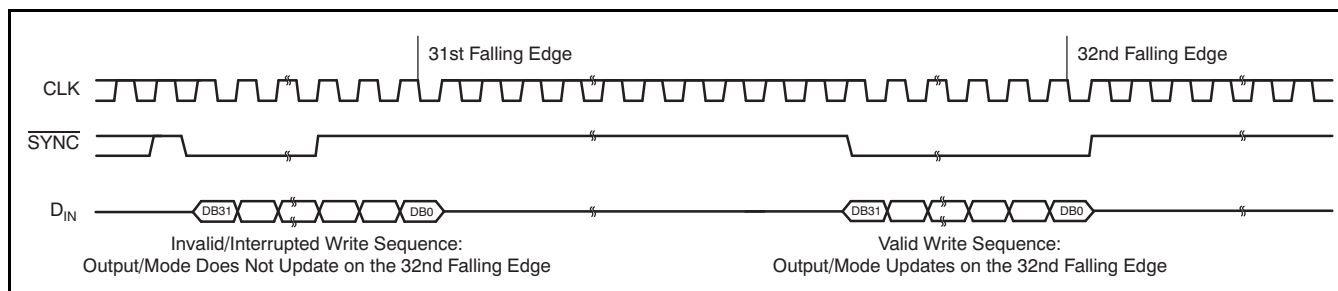

Figure 123. $\overline{\text{SYNC}}$ Interrupt Facility

POWER-DOWN MODES

The DAC7568, DAC8168, and DAC8568 have two separate sets of power-down commands. One set is for the DAC channels and the other set is for the internal reference. For more information on powering down the reference, see the [Enable/Disable Internal Reference](#) section.

DAC Power-Down Commands

The DAC7568, DAC8168, and DAC8568 use four modes of operation. These modes are accessed by setting control bits C3, C2, C1, and C0, and power-down register bits DB8 and DB9. The control bits must be set to '0100'. Once the control bits are set correctly, the four different power down modes are software programmable by setting bits DB8 and DB9 in the control register. [Table 10](#) and [Table 11](#) shows how to control the operating mode with data bits PD0 (DB8), and PD1 (DB9).

Table 11. DAC Operating Modes

PD1 (DB9)	PD0 (DB8)	DAC OPERATING MODES
0	0	Power up selected DACs
0	1	Power down selected DACs 1kΩ to GND
1	0	Power down selected DACs 100kΩ to GND
1	1	Power down selected DACs High-Z to GND

The DAC7568, DAC8168, and DAC8568 treat the power-down condition as data; all the operational modes are still valid for power-down. It is possible to broadcast a power-down condition to all the DAC8568, DAC8168, DAC7568s in a system. It is also possible to power-down a channel and update data on other channels. Furthermore, it is possible to write to the DAC register/buffer of the DAC channel that is powered down. When the DAC channel is then powered up, it will power up to this new value (see the [Operating Examples](#) section).

When both the PD0 and PD1 bits are set to '0', the device works normally with its typical current consumption of 1.25mA at 5.5V. The reference current is included with the operation of all eight

DACs. However, for the three power-down modes, the supply current falls to 0.18μA at 5.5V (0.10μA at 3.6V). Not only does the supply current fall, but the output stage also switches internally from the output of the amplifier to a resistor network of known values.

The advantage of this switching is that the output impedance of the device is known while it is in power-down mode. As described in [Table 11](#), there are three different power-down options. V_{OUT} can be connected internally to GND through a 1kΩ resistor, a 100kΩ resistor, or open circuited (High-Z). The output stage is shown in [Figure 124](#). In other words, DB27, DB26, DB25, and DB24 = '0100' and DB9 and DB8 = '11' represent a power-down condition with High-Z output impedance for a selected channel. DB9 and DB8 = '01' represents a power-down condition with 1kΩ output impedance, and '10' represents a power-down condition with 100kΩ output impedance.

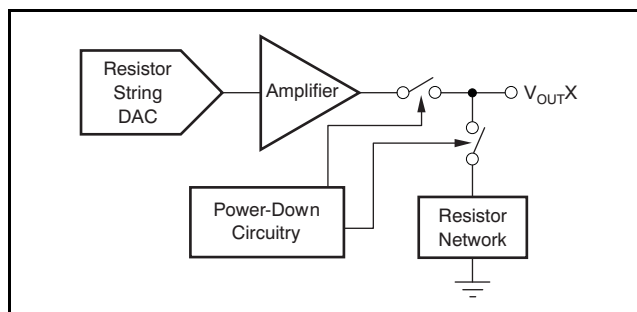

Figure 124. Output Stage During Power-Down

All analog channel circuits are shut down when the power-down mode is exercised. However, the contents of the DAC register are unaffected when in power down. By setting both bits, DB8 and DB9, to different values, any combination of DAC channels can be powered down or powered up. If a DAC channel is being powered up from a previously power down situation, this DAC channel powers up to the value in its DAC register. The time required to exit power-down is typically 2.5μs for $AV_{DD} = 5V$, and 4μs for $AV_{DD} = 3V$. See the [Typical Characteristics](#) for more information.

CLEAR CODE REGISTER and CLR PIN

The DAC7568, DAC8168, and DAC8568 contain a clear code register. The clear code register can be accessed via the serial peripheral interface (SPI) and is user-configurable. Bringing the CLR pin low clears the content of all DAC registers and all DAC buffers, and replaces the code with the code determined by the clear code register. The clear code register can be written to by applying the commands showed in Table 12. The control bits must be set as follows to access the clear code register that is programmed via the feature bits, F0 and F1: C3 = '0', C2 = '1', C1 = '0', and C0 = '1'. The default setting of the clear code register sets the output of all DAC channels to 0V when CLR pin is brought low. The CLR pin is falling-edge triggered; therefore, the device exits clear code mode on the 32nd falling edge of the next write sequence. If CLR pin is brought low during a write

sequence, this write sequence is aborted and the DAC registers and DAC buffers are cleared as described previously.

When performing a software reset of the device, the clear code register is set back to its default mode (DB1 = DB0 = '0'). Setting the clear code register to DB1 = DB0 = '1' ignores any activity on the external CLR pin.

SOFTWARE RESET FUNCTION

The DAC7568, DAC8168, and DAC8568 contain a software reset feature. If the software reset feature is executed, all registers inside the device are reset to default settings; that is, all DAC channels are reset to the power-on reset code (power on reset to zero scale for grades A and C; power on reset to midscale for grades B and D).

Table 12. Clear Code Register

DB31	DB30-DB28	DB27	DB26	DB25	DB24	DB23	DB22	DB21	DB20	DB19-DB10	DB9	DB8	DB7	DB6	DB5	DB4	DB3	DB2	DB1	DB0	DESCRIPTION
0	Don't Care	C3	C2	C1	C0	A3	A2	A1	A0	D16-D7	D6	D5	D4	D3	D2	D1	F3	F2	F1	F0	GENERAL DATA FORMAT
0	X	0	1	0	1	X	X	X	X	X	X	X	X	X	X	X	X	X	0	0	Clear all DAC outputs to zero scale (default mode)
0	X	0	1	0	1	X	X	X	X	X	X	X	X	X	X	X	X	X	0	1	Clear all DAC outputs to midscale
0	X	0	1	0	1	X	X	X	X	X	X	X	X	X	X	X	X	X	1	0	Clear all DAC outputs to full-scale
0	X	0	1	0	1	X	X	X	X	X	X	X	X	X	X	X	X	X	1	1	Ignore external CLR pin

Table 13. Software Reset

DB31	DB30-DB28	DB27	DB26	DB25	DB24	DB23	DB22	DB21	DB20	DB19-DB10	DB9	DB8	DB7	DB6	DB5	DB4	DB3	DB2	DB1	DB0	DESCRIPTION
0	Don't Care	C3	C2	C1	C0	A3	A2	A1	A0	D16-D7	D6	D5	D4	D3	D2	D1	F3	F2	F1	F0	GENERAL DATA FORMAT
0	X	0	1	1	1	X	X	X	X	X	X	X	X	X	X	X	X	X	X	X	Software reset

OPERATING EXAMPLES: DAC7568/DAC8168/DAC8568

For the following examples X = *don't care*; value can be either '0' or '1'.

Example 1: Write to Data Buffer A, B, G, H; Load DAC A, B, G, H Simultaneously
1st: Write to data buffer A:

DB31	DB30-DB28	DB27	DB26	DB25	DB24	DB23	DB22	DB21	DB20	DB19-DB10	DB9	DB8	DB7	DB6	DB5	DB4	DB3	DB2	DB1	DB0
0	Don't Care	C3	C2	C1	C0	A3	A2	A1	A0	D16-D7	D6	D5	D4	D3	D2	D1	F3	F2	F1	F0
0	X	0	0	0	0	0	0	0	0	DATA							X	X	X	X

2nd: Write to data buffer B:

DB31	DB30-DB28	DB27	DB26	DB25	DB24	DB23	DB22	DB21	DB20	DB19-DB10	DB9	DB8	DB7	DB6	DB5	DB4	DB3	DB2	DB1	DB0
0	Don't Care	C3	C2	C1	C0	A3	A2	A1	A0	D16-D7	D6	D5	D4	D3	D2	D1	F3	F2	F1	F0
0	X	0	0	0	0	0	0	0	1	DATA							X	X	X	X

3rd: Write to data buffer G:

DB31	DB30-DB28	DB27	DB26	DB25	DB24	DB23	DB22	DB21	DB20	DB19-DB10	DB9	DB8	DB7	DB6	DB5	DB4	DB3	DB2	DB1	DB0
0	Don't Care	C3	C2	C1	C0	A3	A2	A1	A0	D16-D7	D6	D5	D4	D3	D2	D1	F3	F2	F1	F0
0	X	0	0	0	0	0	1	1	0	DATA							X	X	X	X

4th: Write to data buffer H and simultaneously update all DACs:

DB31	DB30-DB28	DB27	DB26	DB25	DB24	DB23	DB22	DB21	DB20	DB19-DB10	DB9	DB8	DB7	DB6	DB5	DB4	DB3	DB2	DB1	DB0
0	Don't Care	C3	C2	C1	C0	A3	A2	A1	A0	D16-D7	D6	D5	D4	D3	D2	D1	F3	F2	F1	F0
0	X	0	0	1	0	0	1	1	1	DATA							X	X	X	X

The DAC A, DAC B, DAC G, and DAC H analog outputs simultaneously settle to the specified values upon completion of the 4th write sequence. (The DAC voltages update simultaneously after the 32nd SCLK falling edge of the fourth write cycle).

Example 2: Load New Data to DAC C, D, E, F Sequentially

1st: Write to data buffer C and load DAC C: DAC C output settles to specified value upon completion:

DB31	DB30-DB28	DB27	DB26	DB25	DB24	DB23	DB22	DB21	DB20	DB19-DB10	DB9	DB8	DB7	DB6	DB5	DB4	DB3	DB2	DB1	DB0
0	Don't Care	C3	C2	C1	C0	A3	A2	A1	A0	D16-D7	D6	D5	D4	D3	D2	D1	F3	F2	F1	F0
0	X	0	0	1	1	0	0	1	0	DATA							X	X	X	X

2nd: Write to data buffer D and load DAC D: DAC D output settles to specified value upon completion:

DB31	DB30-DB28	DB27	DB26	DB25	DB24	DB23	DB22	DB21	DB20	DB19-DB10	DB9	DB8	DB7	DB6	DB5	DB4	DB3	DB2	DB1	DB0
0	Don't Care	C3	C2	C1	C0	A3	A2	A1	A0	D16-D7	D6	D5	D4	D3	D2	D1	F3	F2	F1	F0
0	X	0	0	1	1	0	0	1	1	DATA							X	X	X	X

3rd: Write to data buffer E and load DAC E: DAC E output settles to specified value upon completion:

DB31	DB30-DB28	DB27	DB26	DB25	DB24	DB23	DB22	DB21	DB20	DB19-DB10	DB9	DB8	DB7	DB6	DB5	DB4	DB3	DB2	DB1	DB0
0	Don't Care	C3	C2	C1	C0	A3	A2	A1	A0	D16-D7	D6	D5	D4	D3	D2	D1	F3	F2	F1	F0
0	X	0	0	1	1	0	1	0	0	DATA							X	X	X	X

4th: Write to data buffer F and load DAC F: DAC F output settles to specified value upon completion:

DB31	DB30-DB28	DB27	DB26	DB25	DB24	DB23	DB22	DB21	DB20	DB19-DB10	DB9	DB8	DB7	DB6	DB5	DB4	DB3	DB2	DB1	DB0
0	Don't Care	C3	C2	C1	C0	A3	A2	A1	A0	D16-D7	D6	D5	D4	D3	D2	D1	F3	F2	F1	F0
0	X	0	0	1	1	0	1	0	1	DATA							X	X	X	X

After completion of each write cycle, the DAC analog output settles to the voltage specified.

Example 3: Power-Down DAC A, DAC B and DAC H to 1kΩ and Power-Down DAC C, DAC D, and DAC F to 100kΩ
1st: Write power-down command to DAC channel A and DAC channel B: DAC A and DAC B to 1kΩ.

DB31	DB30-DB28	DB27	DB26	DB25	DB24	DB23	DB22	DB21	DB20	DB19-DB10	DB9	DB8	DB7	DB6	DB5	DB4	DB3	DB2	DB1	DB0
0	Don't Care	C3	C2	C1	C0	A3	A2	A1	A0	D16-D7	D6	D5	D4	D3	D2	D1	F3	F2	F1	F0
0	X	0	1	0	0	0	0	0	0	0	0	1	0	0	0	0	0	0	1	1

2nd: Write power-down command to DAC channel H: DAC H to 1kΩ.

DB31	DB30-DB28	DB27	DB26	DB25	DB24	DB23	DB22	DB21	DB20	DB19-DB10	DB9	DB8	DB7	DB6	DB5	DB4	DB3	DB2	DB1	DB0
0	Don't Care	C3	C2	C1	C0	A3	A2	A1	A0	D16-D7	D6	D5	D4	D3	D2	D1	F3	F2	F1	F0
0	X	0	1	0	0	0	0	0	0	0	0	1	1	0	0	0	0	0	0	0

3rd: Write power-down command to DAC channel C and DAC channel D: DAC C and DAC D to 100kΩ.

DB31	DB30-DB28	DB27	DB26	DB25	DB24	DB23	DB22	DB21	DB20	DB19-DB10	DB9	DB8	DB7	DB6	DB5	DB4	DB3	DB2	DB1	DB0
0	Don't Care	C3	C2	C1	C0	A3	A2	A1	A0	D16-D7	D6	D5	D4	D3	D2	D1	F3	F2	F1	F0
0	X	0	1	0	0	0	0	0	0	0	1	0	0	0	0	0	1	1	0	0

4th: Write power-down command to DAC channel F: DAC F to 100kΩ.

DB31	DB30-DB28	DB27	DB26	DB25	DB24	DB23	DB22	DB21	DB20	DB19-DB10	DB9	DB8	DB7	DB6	DB5	DB4	DB3	DB2	DB1	DB0
0	Don't Care	C3	C2	C1	C0	A3	A2	A1	A0	D16-D7	D6	D5	D4	D3	D2	D1	F3	F2	F1	F0
0	X	0	1	0	0	0	0	0	0	0	1	0	0	0	1	0	0	0	0	0

The DAC A, DAC B, DAC C, DAC D, DAC F, and DAC H analog outputs power-down to each respective specified mode.

Example 4: Power-Down All Channels Simultaneously while Reference is Always Powered Up

1st: Write sequence for enabling the DAC7568, DAC8168, and DAC8568 internal reference all the time:

DB31	DB30-DB28	DB27	DB26	DB25	DB24	DB23	DB22	DB21	DB20	DB19	DB18	DB17	DB16-DB7	DB6	DB5	DB4	DB3	DB2	DB1	DB0	
0	Don't Care	C3	C2	C1	C0	A3	A2	A1	A0	D16	D15	D14	D13-D4	D3	D2	D1	F3	F2	F1	F0	
0	X	1	0	0	1	X	X	X	X	1	0	1	X	X	X	X	X	X	X	X	X

2nd: Write sequence to power-down all DACs to high-impedance:

DB31	DB30-DB28	DB27	DB26	DB25	DB24	DB23	DB22	DB21	DB20	DB19-DB10	DB9	DB8	DB7	DB6	DB5	DB4	DB3	DB2	DB1	DB0	
0	Don't Care	C3	C2	C1	C0	A3	A2	A1	A0	D16-D7	D6	D5	D4	D3	D2	D1	F3	F2	F1	F0	
0	X	0	1	0	0	X	X	X	X	X	1	1	1	1	1	1	1	1	1	1	1

The DAC A, DAC B, DAC C, DAC D, DAC E, DAC F, DAC G, and DAC H analog outputs simultaneously power-down to high-impedance upon completion of the first and second write sequences, respectively.

Example 5: Write a Specific Value to All DACs while Reference is Always Powered Down

1st: Write sequence for disabling the DAC7568, DAC8168, and DAC8568 internal reference all the time (after this sequence, these devices require an external reference source to function):

DB31	DB30-DB28	DB27	DB26	DB25	DB24	DB23	DB22	DB21	DB20	DB19	DB18	DB17	DB16-DB7	DB6	DB5	DB4	DB3	DB2	DB1	DB0	
0	Don't Care	C3	C2	C1	C0	A3	A2	A1	A0	D16	D15	D14	D13-D4	D3	D2	D1	F3	F2	F1	F0	
0	X	1	0	0	1	X	X	X	X	1	1	0	X	X	X	X	X	X	X	X	X

2nd: Write sequence to write specified data to all DACs:

DB31	DB30-DB28	DB27	DB26	DB25	DB24	DB23	DB22	DB21	DB20	DB19-DB10	DB9	DB8	DB7	DB6	DB5	DB4	DB3	DB2	DB1	DB0
0	Don't Care	C3	C2	C1	C0	A3	A2	A1	A0	D16-D7	D6	D5	D4	D3	D2	D1	F3	F2	F1	F0
0	X	0	0	1	1	1	1	1	1	DATA							X	X	X	X

The DAC A, DAC B, DAC C, DAC D, DAC E, DAC F, DAC G, and DAC H analog outputs simultaneously settle to the specified values upon completion of the second write sequence. (The DAC voltages update simultaneously after the 32nd SCLK falling edge of the second write cycle). Reference is always powered-down (External reference must be used for proper operation).

APPLICATION INFORMATION

INTERNAL REFERENCE

The internal reference of the DAC7568, DAC8168, and DAC8568 does not require an external load capacitor for stability because it is stable with any capacitive load. However, for improved noise performance, an external load capacitor of 150nF or larger connected to the V_{REFH}/V_{REFOUT} output is recommended. Figure 125 shows the typical connections required for operation of the DAC7568, DAC8168, and DAC8568 internal reference. A supply bypass capacitor at the AV_{DD} input is also recommended.

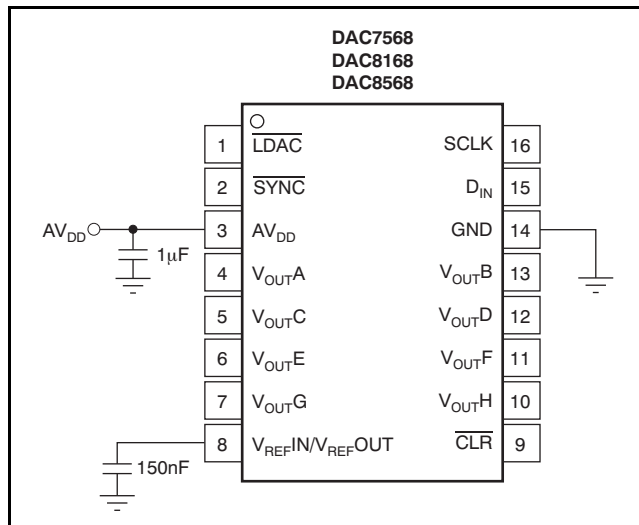

Figure 125. Typical Connections for Operating the DAC7568/DAC8168/DAC8568 Internal Reference (16-Pin Version Shown)

Supply Voltage

The internal reference features an extremely low dropout voltage. It can be operated with a supply of only 5mV above the reference output voltage in an unloaded condition. For loaded conditions, refer to the [Load Regulation](#) section. The stability of the internal reference with variations in supply voltage (line regulation, dc PSRR) is also exceptional. Within the specified supply voltage range of 2.7V to 5.5V, the variation at V_{REFH}/V_{REFOUT} is less than 10µV/V; see the [Typical Characteristics](#).

Temperature Drift

The internal reference is designed to exhibit minimal drift error, defined as the change in reference output voltage over varying temperature. The drift is calculated using the *box* method described by Equation 2:

$$\text{Drift Error} = \left(\frac{V_{REF_MAX} - V_{REF_MIN}}{V_{REF} \times T_{RANGE}} \right) \times 10^6 \text{ (ppm/}^\circ\text{C)} \quad (2)$$

Where:

V_{REF_MAX} = maximum reference voltage observed within temperature range T_{RANGE} .

V_{REF_MIN} = minimum reference voltage observed within temperature range T_{RANGE} .

$V_{REF} = 2.5V$, target value for reference output voltage.

The internal reference (grade C only) features an exceptional typical drift coefficient of 2ppm/°C from –40°C to +125°C. Characterizing a large number of units, a maximum drift coefficient of 5ppm/°C (grade C only) is observed. Temperature drift results are summarized in the [Typical Characteristics](#).

Noise Performance

Typical 0.1Hz to 10Hz voltage noise can be seen in [Figure 9, Internal Reference Noise](#). Additional filtering can be used to improve output noise levels, although care should be taken to ensure the output impedance does not degrade the ac performance. The output noise spectrum at V_{REFH}/V_{REFOUT} without any external components is depicted in [Figure 8, Internal Reference Noise Density vs Frequency](#). A second noise density spectrum is also shown in [Figure 8](#). This spectrum was obtained using a 4.8µF load capacitor at V_{REFH}/V_{REFOUT} for noise filtering. Internal reference noise impacts the DAC output noise; see the [DAC Noise Performance](#) section for more details.

Load Regulation

Load regulation is defined as the change in reference output voltage as a result of changes in load current. The load regulation of the internal reference is measured using force and sense contacts as shown in Figure 126. The force and sense lines reduce the impact of contact and trace resistance, resulting in accurate measurement of the load regulation contributed solely by the internal reference. Measurement results are summarized in the Typical Characteristics. Force and sense lines should be used for applications that require improved load regulation.

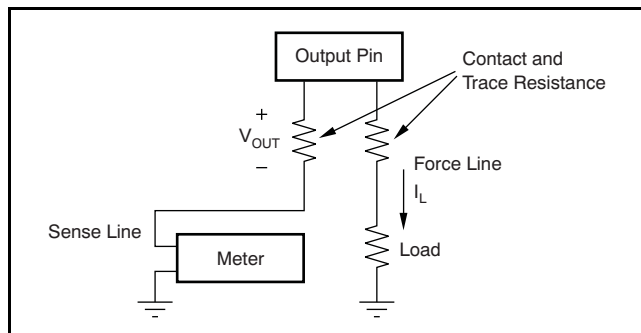

Figure 126. Accurate Load Regulation of the DAC7568/DAC8168/DAC8568 Internal Reference

Long-Term Stability

Long-term stability/aging refers to the change of the output voltage of a reference over a period of months or years. This effect lessens as time progresses (see Figure 7, the typical long-term stability curve). The typical drift value for the internal reference is 50ppm from 0 hours to 1900 hours. This parameter is characterized by powering-up 20 units and measuring them at regular intervals for a period of 1900 hours.

Thermal Hysteresis

Thermal hysteresis for a reference is defined as the change in output voltage after operating the device at +25°C, cycling the device through the operating temperature range, and returning to +25°C. Hysteresis is expressed by Equation 3:

$$V_{\text{HYST}} = \left[\frac{|V_{\text{REF_PRE}} - V_{\text{REF_POST}}|}{V_{\text{REF_NOM}}} \right] \times 10^6 \text{ (ppm/}^\circ\text{C)} \quad (3)$$

Where:

V_{HYST} = thermal hysteresis.

$V_{\text{REF_PRE}}$ = output voltage measured at +25°C pre-temperature cycling.

$V_{\text{REF_POST}}$ = output voltage measured after the device cycles through the temperature range of –40°C to +125°C, and returns to +25°C.

DAC NOISE PERFORMANCE

Typical noise performance for the DAC7568, DAC8168, and DAC8568 with the internal reference enabled is shown in Figure 66 to Figure 67. Output noise spectral density at the V_{OUT} pin versus frequency is depicted in Figure 66 for full-scale, midscale, and zero-scale input codes. The typical noise density for midscale code is 120nV/ $\sqrt{\text{Hz}}$ at 1kHz and 100nV/ $\sqrt{\text{Hz}}$ at 1MHz. High-frequency noise can be improved by filtering the reference noise. Integrated output noise between 0.1Hz and 10Hz is close to 6 μV_{PP} (midscale), as shown in Figure 67.

BIPOLAR OPERATION USING THE DAC7568/DAC8168/DAC8568

The DAC7568, DAC8168, and DAC8568 are designed for single-supply operation, but a bipolar output range is also possible using the circuit in either [Figure 127](#) or [Figure 128](#). The circuit shown gives an output voltage range of $\pm V_{REF}$. Rail-to-rail operation at the amplifier output is achievable using an [OPA703](#) as the output amplifier.

The output voltage for any input code can be calculated with [Equation 4](#):

$$V_{OUT} = \left[V_{REF} \times \text{Gain} \times \left(\frac{D_{IN}}{2^n} \right) \times \left(\frac{R_1 + R_2}{R_1} \right) - V_{REF} \times \left(\frac{R_2}{R_1} \right) \right] \quad (4)$$

Where:

D_{IN} = decimal equivalent of the binary code that is loaded to the DAC register. It can range from 0 to 4095 for DAC7568 (12 bit), 0 to 16,383 for DAC8168 (14 bit), and 0 to 65535 for DAC8568 (16 bit).

n = resolution in bits; either 12 (DAC7568), 14 (DAC8168) or 16 (DAC8568)

Gain = 1 for A/B grades or 2 for C/D grades.

With $V_{REFIN}/V_{REFOUT} = 5V$, $R_1 = R_2 = 10k\Omega$, for grades A and B.

$$V_{OUT} = \left[\frac{10 \times D_{IN}}{2^n} \right] - 5V \quad (5)$$

This result has an output voltage range of $\pm 5V$ with 0000h corresponding to a $-5V$ output and FFFFh corresponding to a $+5V$ output for the 16-bit DAC8568, as shown in [Figure 127](#). Similarly, using the internal reference, a $\pm 2.5V$ output voltage range can be achieved, as [Figure 128](#) shows.

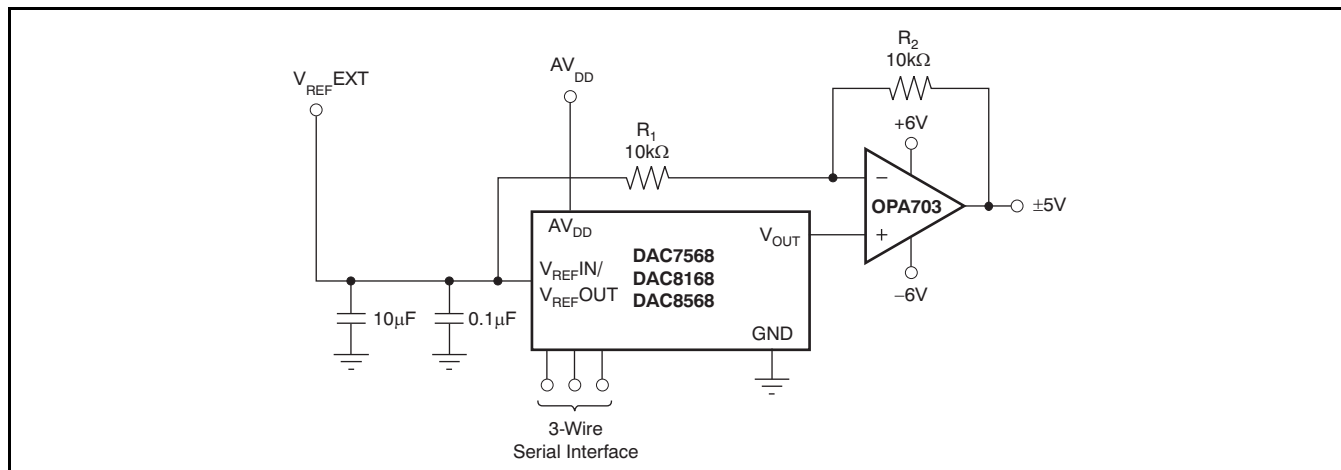

Figure 127. Bipolar Output Range Using External Reference at 5V

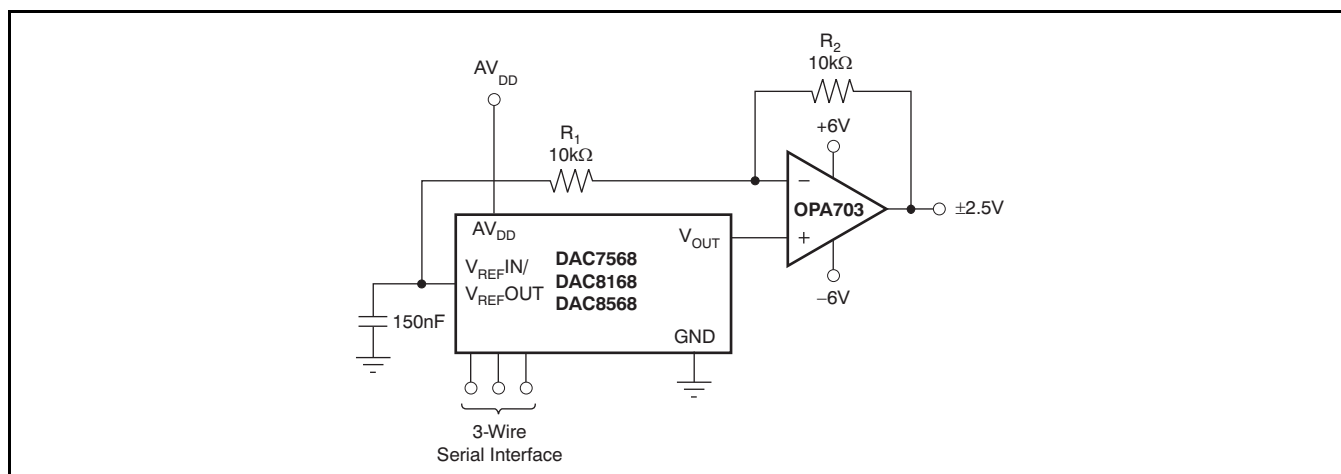

Figure 128. Bipolar Output Range Using Internal Reference

MICROPROCESSOR INTERFACING

DAC7568/DAC8168/DAC8568 to an 8051 Interface

Figure 129 shows a serial interface between the DAC7568, DAC8168, and DAC8568 and a typical 8051-type microcontroller. The setup for the interface is as follows: TXD of the 8051 drives SCLK of the DAC7568, DAC8168, or DAC8568, while RXD drives the serial data line of the device. The $\overline{\text{SYNC}}$ signal is derived from a bit-programmable pin on the port of the 8051; in this case, port line P3.3 is used. When data are to be transmitted to the DAC7568, DAC8168, and DAC8568, P3.3 is taken low. The 8051 transmits data in 8-bit bytes; thus, only eight falling clock edges occur in the transmit cycle. To load data to the DAC, P3.3 is left low after the first eight bits are transmitted; then, a second write cycle is initiated to transmit the second byte of data. P3.3 is taken high following the completion of the third write cycle. The 8051 outputs the serial data in a format that has the LSB first. The DAC7568, DAC8168, and DAC8568 require the data with the MSB as the first bit received. Therefore, the 8051 transmit routine must take this requirement into account, and *mirror* the data as needed.

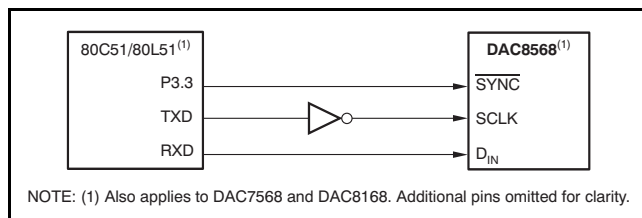

Figure 129. DAC7568/DAC8168/DAC8568 to 80C51/80L51 Interface

DAC7568/DAC8168/DAC8568 to Microwire Interface

Figure 130 shows an interface between the DAC7568, DAC8168, and DAC8568 and any Microwire-compatible device. Serial data are shifted out on the falling edge of the serial clock and are clocked into the DAC7568, DAC8168, and DAC8568 on the rising edge of the SK signal.

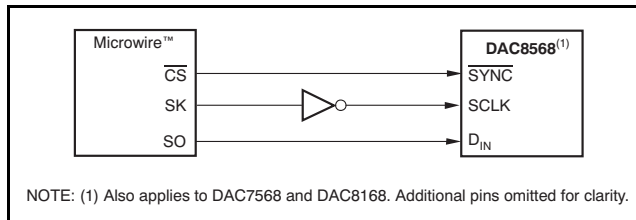

Figure 130. DAC7568/DAC8168/DAC8568 to Microwire Interface

DAC7568/DAC8168/DAC8568 to 68HC11 Interface

Figure 131 shows a serial interface between the DAC7568/DAC8168/DAC8568 and the 68HC11 microcontroller. SCK of the 68HC11 drives the SCLK of the DAC7568, DAC8168, and DAC8568, while the MOSI output drives the serial data line of the DAC. The $\overline{\text{SYNC}}$ signal derives from a port line (PC7), similar to the 8051 diagram.

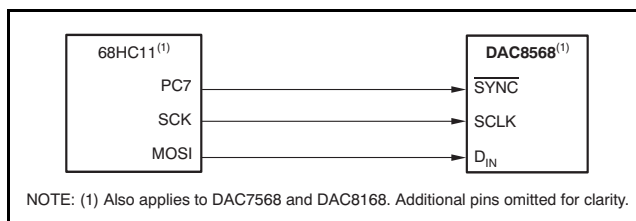

Figure 131. DAC7568/DAC8168/DAC8568 to 68HC11 Interface

The 68HC11 should be configured so that its CPOL bit is '0' and its CPHA bit is '1'. This configuration causes data appearing on the MOSI output to be valid on the falling edge of SCK. When data are being transmitted to the DAC, the $\overline{\text{SYNC}}$ line is held low (PC7). Serial data from the 68HC11 are transmitted in 8-bit bytes with only eight falling clock edges occurring in the transmit cycle. (Data are transmitted MSB first.) In order to load data to the DAC7568, DAC8168, and DAC8568, PC7 is left low after the first eight bits are transferred; then, a second and third serial write operation are performed to the DAC. PC7 is taken high at the end of this procedure.

LAYOUT

A precision analog component requires careful layout, adequate bypassing, and clean, well-regulated power supplies.

The DAC7568, DAC8168, and DAC8568 offer single-supply operation, and are often used in close proximity with digital logic, microcontrollers, microprocessors, and digital signal processors. The more digital logic present in the design and the higher the switching speed, the more difficult it is to keep digital noise from appearing at the output.

As a result of the single ground pin of the DAC7568, DAC8168, and DAC8568, all return currents (including digital and analog return currents for the DAC) must flow through a single point. Ideally, GND would be connected directly to an analog ground plane. This plane would be separate from the ground connection for the digital components until they were connected at the power-entry point of the system.

The power applied to AV_{DD} should be well-regulated and low noise. Switching power supplies and dc/dc converters often have high-frequency glitches or spikes riding on the output voltage. In addition, digital components can create similar high-frequency spikes as their internal logic switches states. This noise can easily couple into the DAC output voltage through various paths between the power connections and analog output.

As with the GND connection, AV_{DD} should be connected to a power-supply plane or trace that is separate from the connection for digital logic until they are connected at the power-entry point. In addition, a $1\mu\text{F}$ to $10\mu\text{F}$ capacitor and $0.1\mu\text{F}$ bypass capacitor are strongly recommended. In some situations, additional bypassing may be required, such as a $100\mu\text{F}$ electrolytic capacitor or even a π filter made up of inductors and capacitors—all designed to essentially low-pass filter the supply and remove the high-frequency noise.

PARAMETER DEFINITIONS

With the increased complexity of many different specifications listed in product data sheets, this section summarizes selected specifications related to digital-to-analog converters.

STATIC PERFORMANCE

Static performance parameters are specifications such as differential nonlinearity (DNL) or integral nonlinearity (INL). These are dc specifications and provide information on the accuracy of the DAC. They are most important in applications where the signal changes slowly and accuracy is required.

Resolution

Generally, the DAC resolution can be expressed in different forms. Specifications such as IEC 60748-4 recognize the numerical, analog, and relative resolution. The numerical resolution is defined as the number of digits in the chosen numbering system necessary to express the total number of steps of the transfer characteristic, where a step represents both a digital input code and the corresponding discrete analogue output value. The most commonly-used definition of resolution provided in data sheets is the numerical resolution expressed in bits.

Least Significant Bit (LSB)

The least significant bit (LSB) is defined as the smallest value in a binary coded system. The value of the LSB can be calculated by dividing the full-scale output voltage by 2^n , where n is the resolution of the converter.

Most Significant Bit (MSB)

The most significant bit (MSB) is defined as the largest value in a binary coded system. The value of the MSB can be calculated by dividing the full-scale output voltage by 2. Its value is one-half of full-scale.

Relative Accuracy or Integral Nonlinearity (INL)

Relative accuracy or integral nonlinearity (INL) is defined as the maximum deviation between the real transfer function and a straight line passing through the endpoints of the ideal DAC transfer function. DNL is measured in LSBs.

Differential Nonlinearity (DNL)

Differential nonlinearity (DNL) is defined as the maximum deviation of the real LSB step from the ideal 1LSB step. Ideally, any two adjacent digital codes correspond to output analog voltages that are exactly one LSB apart. If the DNL is less than 1LSB, the DAC is said to be monotonic.

Full-Scale Error

Full-scale error is defined as the deviation of the real full-scale output voltage from the ideal output voltage while the DAC register is loaded with the full-scale code (0xFFFF). Ideally, the output should be $AV_{DD} - 1$ LSB. The full-scale error is expressed in percent of full-scale range (%FSR).

Offset Error

The offset error is defined as the difference between actual output voltage and the ideal output voltage in the linear region of the transfer function. This difference is calculated by using a straight line defined by two codes (code 485 and 64714). Since the offset error is defined by a straight line, it can have a negative or positive value. Offset error is measured in mV.

Zero-Code Error

The zero-code error is defined as the DAC output voltage, when all '0's are loaded into the DAC register. Zero-scale error is a measure of the difference between actual output voltage and ideal output voltage (0V). It is expressed in mV. It is primarily caused by offsets in the output amplifier.

Gain Error

Gain error is defined as the deviation in the slope of the real DAC transfer characteristic from the ideal transfer function. Gain error is expressed as a percentage of full-scale range (%FSR).

Full-Scale Error Drift

Full-scale error drift is defined as the change in full-scale error with a change in temperature. Full-scale error drift is expressed in units of %FSR/°C.

Offset Error Drift

Offset error drift is defined as the change in offset error with a change in temperature. Offset error drift is expressed in $\mu\text{V}/^\circ\text{C}$.

Zero-Code Error Drift

Zero-code error drift is defined as the change in zero-code error with a change in temperature. Zero-code error drift is expressed in $\mu\text{V}/^\circ\text{C}$.

Gain Temperature Coefficient

The gain temperature coefficient is defined as the change in gain error with changes in temperature. The gain temperature coefficient is expressed in ppm of FSR/°C.

Power-Supply Rejection Ratio (PSRR)

Power-supply rejection ratio (PSRR) is defined as the ratio of change in output voltage to a change in supply voltage for a full-scale output of the DAC. The PSRR of a device indicates how the output of the DAC is affected by changes in the supply voltage. PSRR is measured in decibels (dB).

Monotonicity

Monotonicity is defined as a slope whose sign does not change. If a DAC is monotonic, the output changes in the same direction or remains at least constant for each step increase (or decrease) in the input code.

DYNAMIC PERFORMANCE

Dynamic performance parameters are specifications such as settling time or slew rate, which are important in applications where the signal rapidly changes and/or high frequency signals are present.

Slew Rate

The output slew rate (SR) of an amplifier or other electronic circuit is defined as the maximum rate of change of the output voltage for all possible input signals.

$$SR = \max \left(\left| \frac{\Delta V_{OUT}(t)}{\Delta t} \right| \right)$$

Where $\Delta V_{OUT}(t)$ is the output produced by the amplifier as a function of time t .

Output Voltage Settling Time

Settling time is the total time (including slew time) for the DAC output to settle within an error band around its final value after a change in input. Settling times are specified to within $\pm 0.003\%$ (or whatever value is specified) of full-scale range (FSR).

Code Change/Digital-to-Analog Glitch Energy

Digital-to-analog glitch impulse is the impulse injected into the analog output when the input code in the DAC register changes state. It is normally specified as the area of the glitch in nanovolt-seconds (nV-s), and is measured when the digital input code is changed by 1LSB at the major carry transition.

Digital Feedthrough

Digital feedthrough is defined as impulse seen at the output of the DAC from the digital inputs of the DAC. It is measured when the DAC output is not updated. It is specified in nV-s, and measured with a full-scale code change on the data bus; that is, from all '0's to all '1's and vice versa.

Channel-to-Channel DC Crosstalk

Channel-to-channel dc crosstalk is defined as the dc change in the output level of one DAC channel in response to a change in the output of another DAC channel. It is measured with a full-scale output change on one DAC channel while monitoring another DAC channel remains at midscale. It is expressed in LSB.

Channel-to-Channel AC Crosstalk

AC crosstalk in a multi-channel DAC is defined as the amount of ac interference experienced on the output of a channel at a frequency (f) (and its harmonics), when the output of an adjacent channel changes its value at the rate of frequency (f). It is measured with one channel output oscillating with a sine wave of 1kHz frequency, while monitoring the amplitude of 1kHz harmonics on an adjacent DAC channel output (kept at zero scale). It is expressed in dB.

Signal-to-Noise Ratio (SNR)

Signal-to-noise ratio (SNR) is defined as the ratio of the root mean-squared (RMS) value of the output signal divided by the RMS values of the sum of all other spectral components below one-half the output frequency, not including harmonics or dc. SNR is measured in dB.

Total Harmonic Distortion (THD)

Total harmonic distortion + noise is defined as the ratio of the RMS values of the harmonics and noise to the value of the fundamental frequency. It is expressed in a percentage of the fundamental frequency amplitude at sampling rate f_s .

Spurious-Free Dynamic Range (SFDR)

Spurious-free dynamic range (SFDR) is the usable dynamic range of a DAC before spurious noise interferes or distorts the fundamental signal. SFDR is the measure of the difference in amplitude between the fundamental and the largest harmonically or non-harmonically related spur from dc to the full Nyquist bandwidth (half the DAC sampling rate, or $f_s/2$). A spur is any frequency bin on a spectrum analyzer, or from a Fourier transform, of the analog output of the DAC. SFDR is specified in decibels relative to the carrier (dBc).

Signal-to-Noise plus Distortion (SINAD)

SINAD includes all the harmonic and outstanding spurious components in the definition of output noise power in addition to quantizing any internal random noise power. SINAD is expressed in dB at a specified input frequency and sampling rate, f_s .

DAC Output Noise Density

Output noise density is defined as internally-generated random noise. Random noise is characterized as a spectral density (nV/\sqrt{Hz}). It is measured by loading the DAC to midscale and measuring noise at the output.

DAC Output Noise

DAC output noise is defined as any voltage deviation of DAC output from the desired value (within a particular frequency band). It is measured with a DAC channel kept at midscale while filtering the output voltage within a band of 0.1Hz to 10Hz and measuring its amplitude peaks. It is expressed in terms of peak-to-peak voltage (V_{pp}).

Full-Scale Range (FSR)

Full-scale range (FSR) is the difference between the maximum and minimum analog output values that the DAC is specified to provide; typically, the maximum and minimum values are also specified. For an n -bit DAC, these values are usually given as the values matching with code 0 and 2^n .

PACKAGING INFORMATION

Orderable Device	Status ⁽¹⁾	Package Type	Package Drawing	Pins	Package Qty	Eco Plan ⁽²⁾	Lead/Ball Finish	MSL Peak Temp ⁽³⁾
DAC7568IAPW	ACTIVE	TSSOP	PW	14	90	Green (RoHS & no Sb/Br)	CU NIPDAU	Level-2-260C-1 YEAR
DAC7568IAPWR	ACTIVE	TSSOP	PW	14	2000	Green (RoHS & no Sb/Br)	CU NIPDAU	Level-2-260C-1 YEAR
DAC7568ICPW	ACTIVE	TSSOP	PW	16	90	Green (RoHS & no Sb/Br)	CU NIPDAU	Level-2-260C-1 YEAR
DAC7568ICPWR	ACTIVE	TSSOP	PW	16	2000	Green (RoHS & no Sb/Br)	CU NIPDAU	Level-2-260C-1 YEAR
DAC8168IAPW	ACTIVE	TSSOP	PW	14	90	Green (RoHS & no Sb/Br)	CU NIPDAU	Level-2-260C-1 YEAR
DAC8168IAPWR	ACTIVE	TSSOP	PW	14	2000	Green (RoHS & no Sb/Br)	CU NIPDAU	Level-2-260C-1 YEAR
DAC8168ICPW	ACTIVE	TSSOP	PW	16	90	Green (RoHS & no Sb/Br)	CU NIPDAU	Level-2-260C-1 YEAR
DAC8168ICPWR	ACTIVE	TSSOP	PW	16	2000	Green (RoHS & no Sb/Br)	CU NIPDAU	Level-2-260C-1 YEAR
DAC8568IAPW	ACTIVE	TSSOP	PW	16	90	Green (RoHS & no Sb/Br)	CU NIPDAU	Level-2-260C-1 YEAR
DAC8568IAPWR	ACTIVE	TSSOP	PW	16	2000	Green (RoHS & no Sb/Br)	CU NIPDAU	Level-2-260C-1 YEAR
DAC8568IBPW	ACTIVE	TSSOP	PW	16	90	Green (RoHS & no Sb/Br)	CU NIPDAU	Level-2-260C-1 YEAR
DAC8568IBPWR	ACTIVE	TSSOP	PW	16	2000	Green (RoHS & no Sb/Br)	CU NIPDAU	Level-2-260C-1 YEAR
DAC8568ICPW	ACTIVE	TSSOP	PW	16	90	Green (RoHS & no Sb/Br)	CU NIPDAU	Level-2-260C-1 YEAR
DAC8568ICPWR	ACTIVE	TSSOP	PW	16	2000	Green (RoHS & no Sb/Br)	CU NIPDAU	Level-2-260C-1 YEAR
DAC8568IDPW	ACTIVE	TSSOP	PW	16	90	Green (RoHS & no Sb/Br)	CU NIPDAU	Level-2-260C-1 YEAR
DAC8568IDPWR	ACTIVE	TSSOP	PW	16	2000	Green (RoHS & no Sb/Br)	CU NIPDAU	Level-2-260C-1 YEAR

⁽¹⁾ The marketing status values are defined as follows:

ACTIVE: Product device recommended for new designs.

LIFEBUY: TI has announced that the device will be discontinued, and a lifetime-buy period is in effect.

NRND: Not recommended for new designs. Device is in production to support existing customers, but TI does not recommend using this part in a new design.

PREVIEW: Device has been announced but is not in production. Samples may or may not be available.

OBsolete: TI has discontinued the production of the device.

⁽²⁾ Eco Plan - The planned eco-friendly classification: Pb-Free (RoHS), Pb-Free (RoHS Exempt), or Green (RoHS & no Sb/Br) - please check <http://www.ti.com/productcontent> for the latest availability information and additional product content details.

TBD: The Pb-Free/Green conversion plan has not been defined.

Pb-Free (RoHS): TI's terms "Lead-Free" or "Pb-Free" mean semiconductor products that are compatible with the current RoHS requirements for all 6 substances, including the requirement that lead not exceed 0.1% by weight in homogeneous materials. Where designed to be soldered at high temperatures, TI Pb-Free products are suitable for use in specified lead-free processes.

Pb-Free (RoHS Exempt): This component has a RoHS exemption for either 1) lead-based flip-chip solder bumps used between the die and package, or 2) lead-based die adhesive used between the die and leadframe. The component is otherwise considered Pb-Free (RoHS compatible) as defined above.

Green (RoHS & no Sb/Br): TI defines "Green" to mean Pb-Free (RoHS compatible), and free of Bromine (Br) and Antimony (Sb) based flame retardants (Br or Sb do not exceed 0.1% by weight in homogeneous material)

⁽³⁾ MSL, Peak Temp. -- The Moisture Sensitivity Level rating according to the JEDEC industry standard classifications, and peak solder temperature.

Important Information and Disclaimer:The information provided on this page represents TI's knowledge and belief as of the date that it is provided. TI bases its knowledge and belief on information provided by third parties, and makes no representation or warranty as to the accuracy of such information. Efforts are underway to better integrate information from third parties. TI has taken and continues to take reasonable steps to provide representative and accurate information but may not have conducted destructive testing or chemical analysis on incoming materials and chemicals. TI and TI suppliers consider certain information to be proprietary, and thus CAS numbers and other limited information may not be available for release.

In no event shall TI's liability arising out of such information exceed the total purchase price of the TI part(s) at issue in this document sold by TI to Customer on an annual basis.

TAPE AND REEL INFORMATION

QUADRANT ASSIGNMENTS FOR PIN 1 ORIENTATION IN TAPE

*All dimensions are nominal

Device	Package Type	Package Drawing	Pins	SPQ	Reel Diameter (mm)	Reel Width W1 (mm)	A0 (mm)	B0 (mm)	K0 (mm)	P1 (mm)	W (mm)	Pin1 Quadrant
DAC8168ICPWR	TSSOP	PW	16	2000	330.0	12.4	6.9	5.6	1.6	8.0	12.0	Q1

TAPE AND REEL BOX DIMENSIONS



*All dimensions are nominal

Device	Package Type	Package Drawing	Pins	SPQ	Length (mm)	Width (mm)	Height (mm)
DAC8168ICPWR	TSSOP	PW	16	2000	346.0	346.0	29.0

PW (R-PDSO-G**)

PLASTIC SMALL-OUTLINE PACKAGE

14 PINS SHOWN

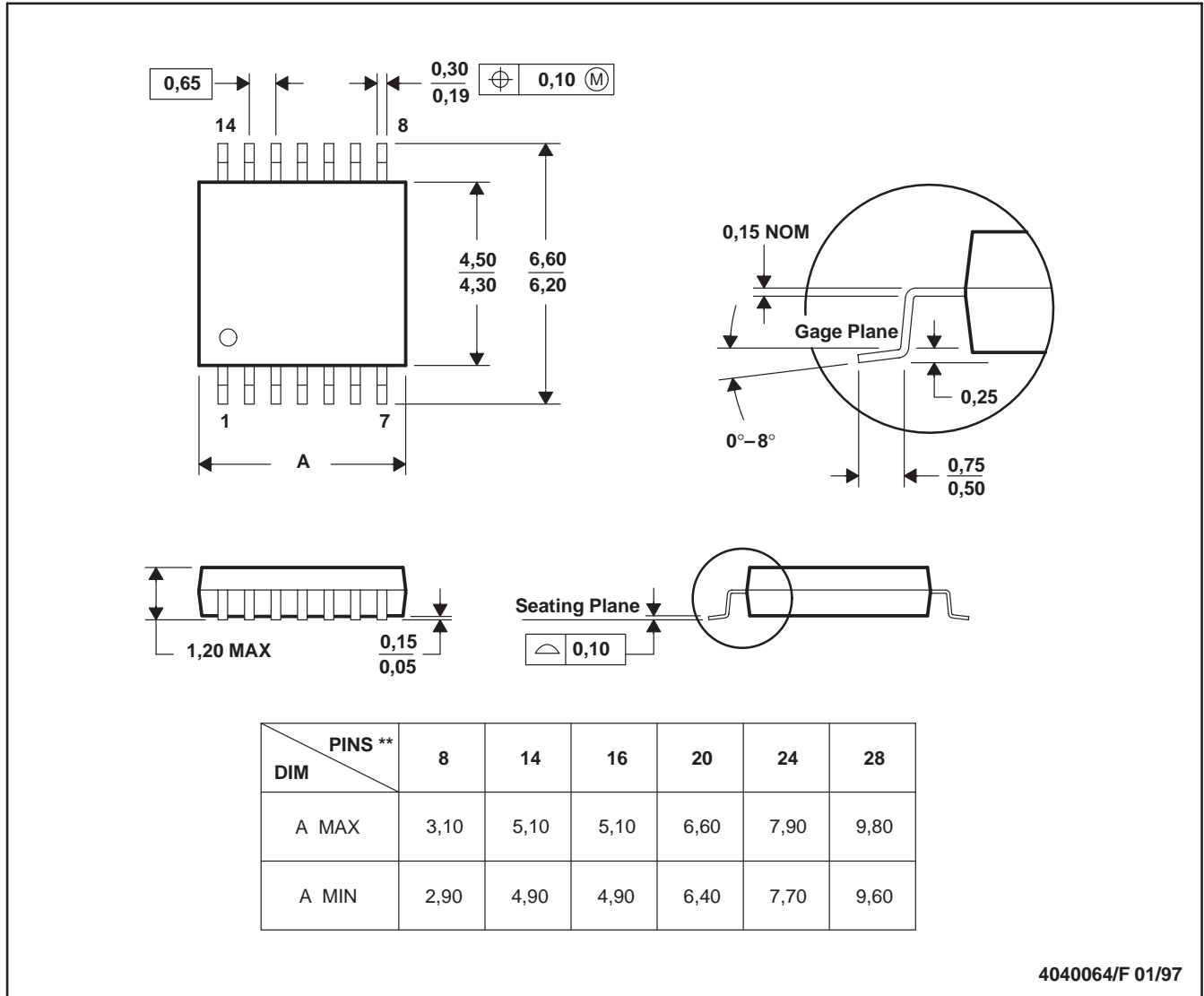

4040064/F 01/97

- NOTES: A. All linear dimensions are in millimeters.
 B. This drawing is subject to change without notice.
 C. Body dimensions do not include mold flash or protrusion not to exceed 0,15.
 D. Falls within JEDEC MO-153

IMPORTANT NOTICE

Texas Instruments Incorporated and its subsidiaries (TI) reserve the right to make corrections, modifications, enhancements, improvements, and other changes to its products and services at any time and to discontinue any product or service without notice. Customers should obtain the latest relevant information before placing orders and should verify that such information is current and complete. All products are sold subject to TI's terms and conditions of sale supplied at the time of order acknowledgment.

TI warrants performance of its hardware products to the specifications applicable at the time of sale in accordance with TI's standard warranty. Testing and other quality control techniques are used to the extent TI deems necessary to support this warranty. Except where mandated by government requirements, testing of all parameters of each product is not necessarily performed.

TI assumes no liability for applications assistance or customer product design. Customers are responsible for their products and applications using TI components. To minimize the risks associated with customer products and applications, customers should provide adequate design and operating safeguards.

TI does not warrant or represent that any license, either express or implied, is granted under any TI patent right, copyright, mask work right, or other TI intellectual property right relating to any combination, machine, or process in which TI products or services are used. Information published by TI regarding third-party products or services does not constitute a license from TI to use such products or services or a warranty or endorsement thereof. Use of such information may require a license from a third party under the patents or other intellectual property of the third party, or a license from TI under the patents or other intellectual property of TI.

Reproduction of TI information in TI data books or data sheets is permissible only if reproduction is without alteration and is accompanied by all associated warranties, conditions, limitations, and notices. Reproduction of this information with alteration is an unfair and deceptive business practice. TI is not responsible or liable for such altered documentation. Information of third parties may be subject to additional restrictions.

Resale of TI products or services with statements different from or beyond the parameters stated by TI for that product or service voids all express and any implied warranties for the associated TI product or service and is an unfair and deceptive business practice. TI is not responsible or liable for any such statements.

TI products are not authorized for use in safety-critical applications (such as life support) where a failure of the TI product would reasonably be expected to cause severe personal injury or death, unless officers of the parties have executed an agreement specifically governing such use. Buyers represent that they have all necessary expertise in the safety and regulatory ramifications of their applications, and acknowledge and agree that they are solely responsible for all legal, regulatory and safety-related requirements concerning their products and any use of TI products in such safety-critical applications, notwithstanding any applications-related information or support that may be provided by TI. Further, Buyers must fully indemnify TI and its representatives against any damages arising out of the use of TI products in such safety-critical applications.

TI products are neither designed nor intended for use in military/aerospace applications or environments unless the TI products are specifically designated by TI as military-grade or "enhanced plastic." Only products designated by TI as military-grade meet military specifications. Buyers acknowledge and agree that any such use of TI products which TI has not designated as military-grade is solely at the Buyer's risk, and that they are solely responsible for compliance with all legal and regulatory requirements in connection with such use.

TI products are neither designed nor intended for use in automotive applications or environments unless the specific TI products are designated by TI as compliant with ISO/TS 16949 requirements. Buyers acknowledge and agree that, if they use any non-designated products in automotive applications, TI will not be responsible for any failure to meet such requirements.

Following are URLs where you can obtain information on other Texas Instruments products and application solutions:

Products		Applications	
Amplifiers	amplifier.ti.com	Audio	www.ti.com/audio
Data Converters	dataconverter.ti.com	Automotive	www.ti.com/automotive
DLP® Products	www.dlp.com	Communications and Telecom	www.ti.com/communications
DSP	dsp.ti.com	Computers and Peripherals	www.ti.com/computers
Clocks and Timers	www.ti.com/clocks	Consumer Electronics	www.ti.com/consumer-apps
Interface	interface.ti.com	Energy	www.ti.com/energy
Logic	logic.ti.com	Industrial	www.ti.com/industrial
Power Mgmt	power.ti.com	Medical	www.ti.com/medical
Microcontrollers	microcontroller.ti.com	Security	www.ti.com/security
RFID	www.ti-rfid.com	Space, Avionics & Defense	www.ti.com/space-avionics-defense
RF/IF and ZigBee® Solutions	www.ti.com/lprf	Video and Imaging	www.ti.com/video
		Wireless	www.ti.com/wireless-apps

Mailing Address: Texas Instruments, Post Office Box 655303, Dallas, Texas 75265
Copyright © 2010, Texas Instruments Incorporated

www.BDTIC.com/TI