



16-BIT, DUAL CHANNEL, ULTRA-LOW GLITCH, VOLTAGE OUTPUT DIGITAL-TO-ANALOG CONVERTER

FEATURES

- **Relative Accuracy: 4LSB**
- **Glitch Energy: 0.15nV-s**
- **MicroPower Operation:**
155 μ A per Channel at 2.7V
- **Power-On Reset to Zero-Scale**
- **Power Supply: 2.7V to 5.5V**
- **16-Bit Monotonic Over Temperature**
- **Settling Time: 10 μ s to \pm 0.003% FSR**
- **Ultra-Low AC Crosstalk: -100dB Typ**
- **Low-Power Serial Interface with Schmitt-Triggered Inputs**
- **On-Chip Output Buffer Amplifier with Rail-to-Rail Operation**
- **Double-Buffered Input Architecture**
- **Simultaneous or Sequential Output Update and Power-down**
- **Available in a Tiny MSOP-8 Package**

APPLICATIONS

- **Portable Instrumentation**
- **Closed-Loop Servo Control**
- **Process Control**
- **Data Acquisition Systems**
- **Programmable Attenuation**
- **PC Peripherals**

DESCRIPTION

The DAC8552 is a 16-bit, dual channel, voltage output digital-to-analog converter (DAC) offering low power operation and a flexible serial host interface. Each on-chip precision output amplifier allows rail-to-rail output swing to be achieved over the supply range of 2.7V to 5.5V. The device supports a standard 3-wire serial interface capable of operating with input data clock frequencies up to 30MHz for $V_{DD} = 5V$.

The DAC8552 requires an external reference voltage to set the output range of each DAC channel. Also incorporated into the device is a power-on reset circuit which ensures that the DAC outputs power up at zero-scale and remain there until a valid write takes place. The DAC8552 provides a flexible power-down feature, accessed over the serial interface, that reduces the current consumption of the device to 700nA at 5V.

The low-power consumption of this device in normal operation makes it ideally suited for portable, battery-operated equipment and other low-power applications. The power consumption is 0.5mW per channel at 2.7V, reducing to 1 μ W in power-down mode.

The DAC8552 is available in a MSOP-8 package with a specified operating temperature range of -40 $^{\circ}$ C to +105 $^{\circ}$ C.

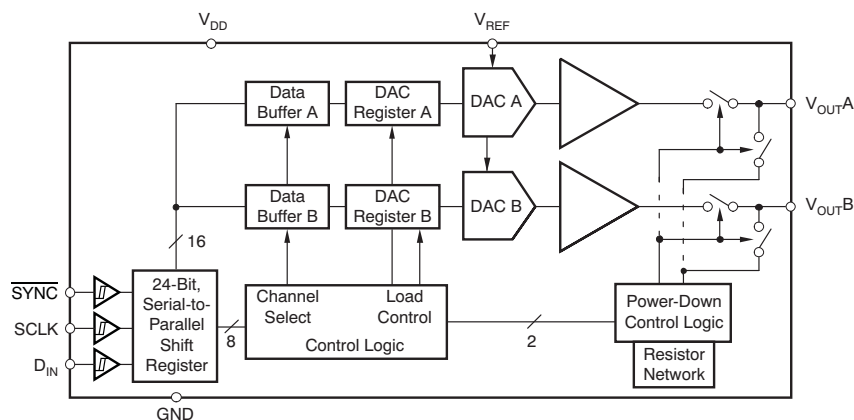

Please be aware that an important notice concerning availability, standard warranty, and use in critical applications of Texas Instruments semiconductor products and disclaimers thereto appears at the end of this data sheet.

SPI, QSP are trademarks of Motorola, Inc.

Microwire is a trademark of National Semiconductor.

All other trademarks are the property of their respective owners.



This integrated circuit can be damaged by ESD. Texas Instruments recommends that all integrated circuits be handled with appropriate precautions. Failure to observe proper handling and installation procedures can cause damage.

ESD damage can range from subtle performance degradation to complete device failure. Precision integrated circuits may be more susceptible to damage because very small parametric changes could cause the device not to meet its published specifications.

PACKAGING/ORDERING INFORMATION⁽¹⁾

PRODUCT	MAXIMUM RELATIVE ACCURACY (LSB)	MAXIMUM DIFFERENTIAL NONLINEARITY (LSB)	PACKAGE LEAD	PACKAGE DESIGNATOR	SPECIFICATION TEMPERATURE RANGE	PACKAGE MARKING	ORDERING NUMBER	TRANSPORT MEDIA, QUANTITY
DAC8552	±12	±1	MSOP-8	DGK	–40°C to +105°C	D82	DAC8552IDGKT	Tape and Reel, 250
							DAC8552IDGKR	Tape and Reel, 2500

(1) For the most current package and ordering information, see the Package Option Addendum at the of this document, or see the TI website at www.ti.com.

ABSOLUTE MAXIMUM RATINGS

over operating free-air temperature range (unless otherwise noted).⁽¹⁾

		UNIT
V _{DD} to GND		–0.3V to 6V
Digital input voltage to GND		–0.3V to V _{DD} + 0.3V
V _{OUTA} or V _{OUTB} to GND		–0.3V to V _{DD} + 0.3V
Operating temperature range		–40°C to +105°C
Storage temperature range		–65°C to +150°C
Junction temperature (T _J max)		+150°C
Power dissipation		(T _J max – T _A)/θ _{JA}
Thermal impedance	θ _{JA}	206°C/W
	θ _{JC}	44°C/W

(1) Stresses above those listed under *Absolute Maximum Ratings* may cause permanent damage to the device. Exposure to absolute maximum conditions for extended periods may affect device reliability.

ELECTRICAL CHARACTERISTICS

V_{DD} = 2.7V to 5.5V, all specifications –40°C to +105°C (unless otherwise noted).

PARAMETER	TEST CONDITIONS	MIN	TYP	MAX	UNIT
STATIC PERFORMANCE⁽¹⁾					
Resolution		16			Bits
Relative accuracy	Measured by line passing through codes 513 and 64741		±4	±12	LSB
Differential nonlinearity	16-bit monotonic		±0.35	±1	LSB
Zero code error	Measured by line passing through codes 485 and 64741		±2.5	±12	mV
Zero code error drift			±5		µV/°C
Full-scale error	Measured by line passing through codes 485 and 64741		±0.1	±0.5	% of FSR
Gain error	Measured by line passing through codes 485 and 64741		±0.08	±0.2	% of FSR
Gain temperature coefficient			±1		ppm of FSR/°C
PSRR	Output unloaded		0.75		mV/V

(1) Linearity calculated using a reduced code range of 513 to 64741. Output unloaded.

ELECTRICAL CHARACTERISTICS (continued)

$V_{DD} = 2.7V$ to $5.5V$, all specifications $-40^{\circ}C$ to $+105^{\circ}C$ (unless otherwise noted).

PARAMETER	TEST CONDITIONS	MIN	TYP	MAX	UNIT
OUTPUT CHARACTERISTICS⁽²⁾					
Output voltage range		0		V_{REF}	V
Output voltage settling time	$T_0 \pm 0.003\%$ FSR 0200h to FD00h, $R_L = 2k\Omega$; $0pF < C_L < 200pF$		8	10	μs
	$R_L = 2k\Omega$; $C_L = 500pF$		12		
Slew rate			1.8		V/ μs
Capacitive load stability	$R_L = \infty$		470		pF
	$R_L = 2k\Omega$		1000		
Code change glitch impulse	1LSB change around major carry		0.15		nV-s
Digital feedthrough	50k Ω series resistance on digital lines		0.15		nV-s
DC crosstalk	Full-scale swing on adjacent channel. $V_{DD} = 5V$, $V_{REF} = 4.096V$		0.25		LSB
AC crosstalk	1kHz sine wave		-100		dB
DC output impedance	At mid-point input		1		Ω
Short circuit current	$V_{DD} = 5V$		50		mA
	$V_{DD} = 3V$		20		
Power-up time	Coming out of power-down mode, $V_{DD} = 5V$		2.5		μs
	Coming out of power-down mode, $V_{DD} = 3V$		5		μs
AC PERFORMANCE					
SNR	$BW = 20kHz$, $V_{DD} = 5V$, $f_{OUT} = 1kHz$, 1st 19 harmonics removed for SNR calculation		95		dB
THD			-85		
SFDR			87		
SINAD			84		
REFERENCE INPUT					
Reference current	$V_{REF} = V_{DD} = 5.5V$		90	120	μA
	$V_{REF} = V_{DD} = 3.6V$		60	100	
Reference input range		0		V_{DD}	V
Reference input impedance			62		k Ω
LOGIC INPUTS⁽²⁾					
Input current				± 1	μA
V_{INL} , Input LOW voltage	$V_{DD} = 5V$			0.8	V
	$V_{DD} = 3V$			0.6	
V_{INH} , Input HIGH voltage	$V_{DD} = 5V$	2.4			V
	$V_{DD} = 3V$	2.1			
Pin capacitance				3	pF
POWER REQUIREMENTS					
V_{DD}		2.7		5.5	V
I_{DD} (normal mode)	Input code = 32768, no load, does not include reference current				
$V_{DD} = 3.6V$ to $5.5V$ $V_{DD} = 2.7V$ to $3.6V$	$V_{IH} = V_{DD}$ and $V_{IL} = GND$		340	500	μA
			310	480	
I_{DD} (all power-down modes)					
$V_{DD} = 3.6V$ to $5.5V$ $V_{DD} = 2.7V$ to $3.6V$	$V_{IH} = V_{DD}$ and $V_{IL} = GND$		0.7	2	μA
			0.4	2	
POWER EFFICIENCY					
I_{OUT}/I_{DD}	$I_{LOAD} = 2mA$, $V_{DD} = 5V$		89		%
TEMPERATURE RANGE					
Specified performance		-40		+105	$^{\circ}C$

(2) Specified by design and characterization; not production tested.

PIN CONFIGURATION

DGK PACKAGE
MSOP-8
(Top View)

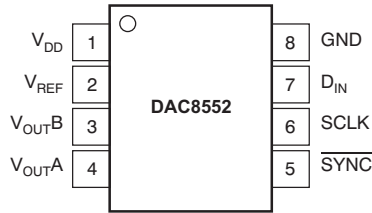

PIN DESCRIPTIONS

PIN	NAME	FUNCTION
1	V _{DD}	Power supply input, 2.7V to 5.5V
2	V _{REF}	Reference voltage input
3	V _{OUTB}	Analog output voltage from DAC B
4	V _{OUTA}	Analog output voltage from DAC A
5	$\overline{\text{SYNC}}$	Level triggered $\overline{\text{SYNC}}$ input (active LOW). This is the frame synchronization signal for the input data. When $\overline{\text{SYNC}}$ goes LOW, it enables the input shift register and data is transferred on the falling edges of SCLK. The action specified by the 8-bit control byte and 16-bit data word is executed following the 24th falling SCLK clock edge (unless $\overline{\text{SYNC}}$ is taken HIGH before this edge, in which case the rising edge of $\overline{\text{SYNC}}$ acts as an interrupt and the write sequence is ignored by the DAC8552). Schmitt-Trigger logic input.
6	SCLK	Serial Clock Input. Data can be transferred at rates up to 30MHz at 5V. Schmitt-Trigger logic input.
7	D _{IN}	Serial Data Input. Data is clocked into the 24-bit input shift register on the falling edge of the serial clock input. Schmitt-Trigger logic input.
8	GND	Ground reference point for all circuitry on the part.

SERIAL WRITE OPERATION

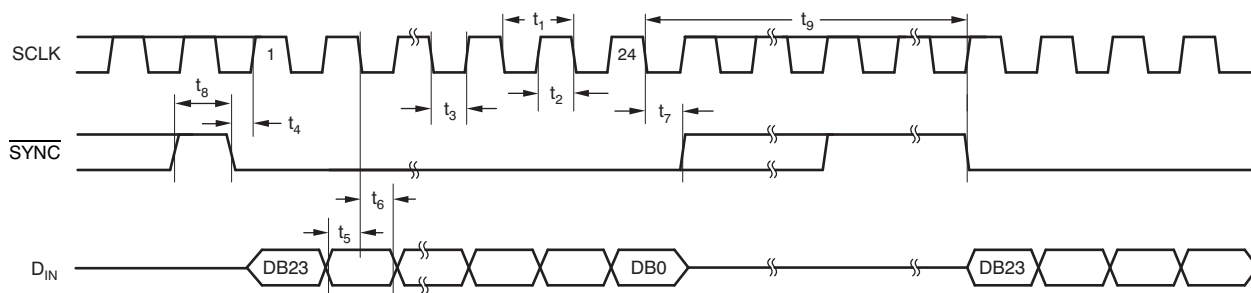

TIMING CHARACTERISTICS⁽¹⁾⁽²⁾

$V_{DD} = 2.7V$ to $5.5V$, all specifications $-40^{\circ}C$ to $+105^{\circ}C$ (unless otherwise noted).

PARAMETER		TEST CONDITIONS	MIN	TYP	MAX	UNIT
$t_1^{(3)}$	SCLK cycle time	$V_{DD} = 2.7V$ to $3.6V$	50			ns
		$V_{DD} = 3.6V$ to $5.5V$	33			
t_2	SCLK HIGH time	$V_{DD} = 2.7V$ to $3.6V$	13			ns
		$V_{DD} = 3.6V$ to $5.5V$	13			
t_3	SCLK LOW time	$V_{DD} = 2.7V$ to $3.6V$	22.5			ns
		$V_{DD} = 3.6V$ to $5.5V$	13			
t_4	\overline{SYNC} to SCLK rising edge setup time	$V_{DD} = 2.7V$ to $3.6V$	0			ns
		$V_{DD} = 3.6V$ to $5.5V$	0			
t_5	Data setup time	$V_{DD} = 2.7V$ to $3.6V$	5			ns
		$V_{DD} = 3.6V$ to $5.5V$	5			
t_6	Data hold time	$V_{DD} = 2.7V$ to $3.6V$	4.5			ns
		$V_{DD} = 3.6V$ to $5.5V$	4.5			
t_7	24th SCLK falling edge to \overline{SYNC} rising edge	$V_{DD} = 2.7V$ to $3.6V$	0			ns
		$V_{DD} = 3.6V$ to $5.5V$	0			
t_8	Minimum \overline{SYNC} HIGH time	$V_{DD} = 2.7V$ to $3.6V$	50			ns
		$V_{DD} = 3.6V$ to $5.5V$	33			
t_9	24th SCLK falling edge to \overline{SYNC} falling edge	$V_{DD} = 2.7V$ to $5.5V$	100			ns

(1) All input signals are specified with $t_R = t_F = 5ns$ (10% to 90% of V_{DD}) and timed from a voltage level of $(V_{IL} + V_{IH})/2$.

(2) See [Serial Write Operation Timing Diagram](#).

(3) Maximum SCLK frequency is 30MHz at $V_{DD} = 3.6V$ to $5.5V$ and 20MHz at $V_{DD} = 2.7V$ to $3.6V$.

TYPICAL CHARACTERISTICS: $V_{DD} = 5V$

At $T_A = +25^\circ C$, unless otherwise noted.

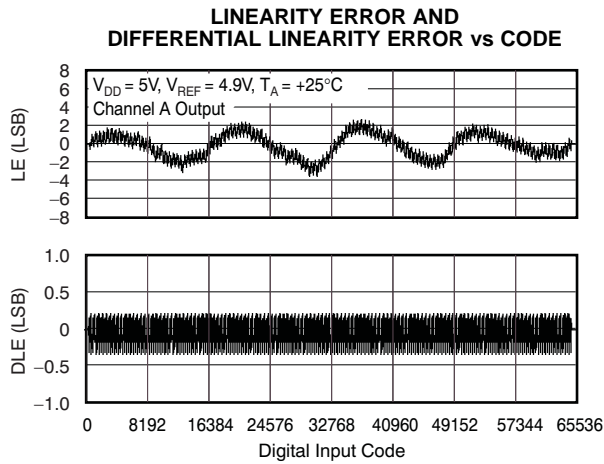

Figure 1.

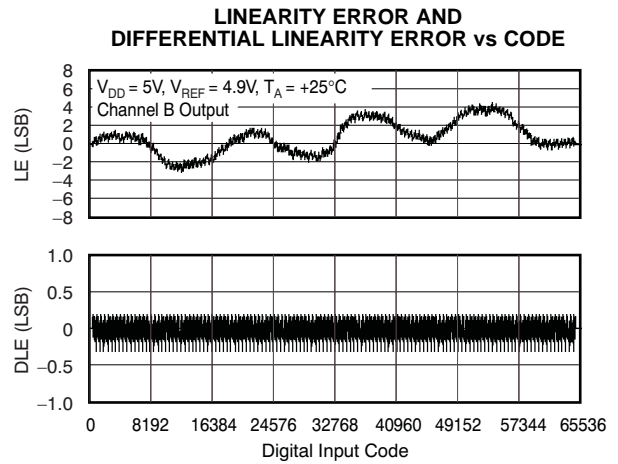

Figure 2.

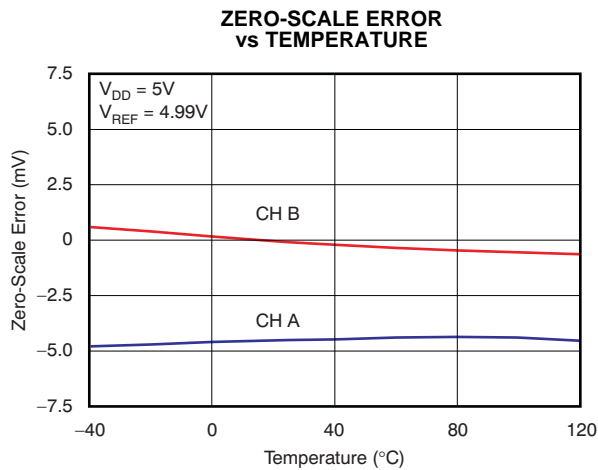

Figure 3.

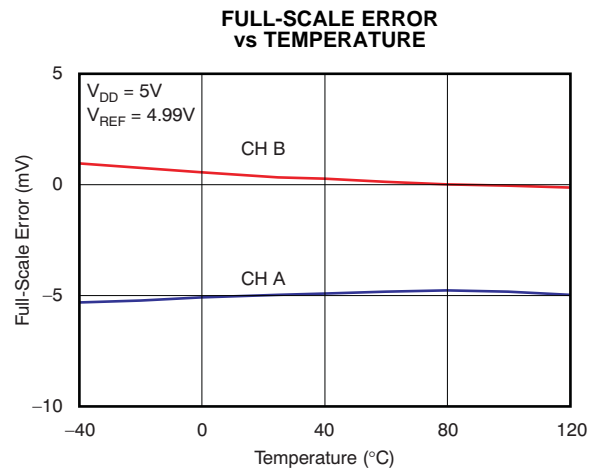

Figure 4.

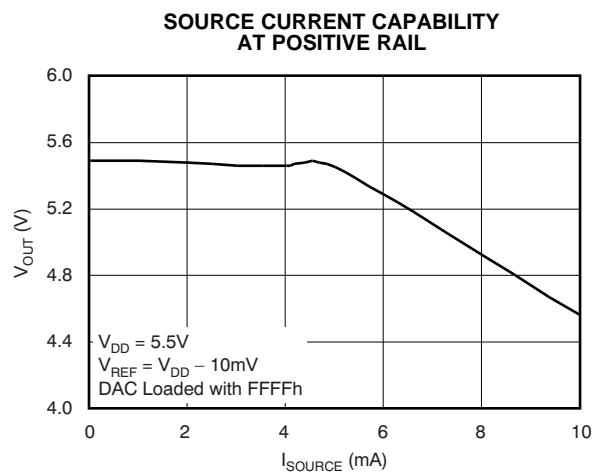

Figure 5.

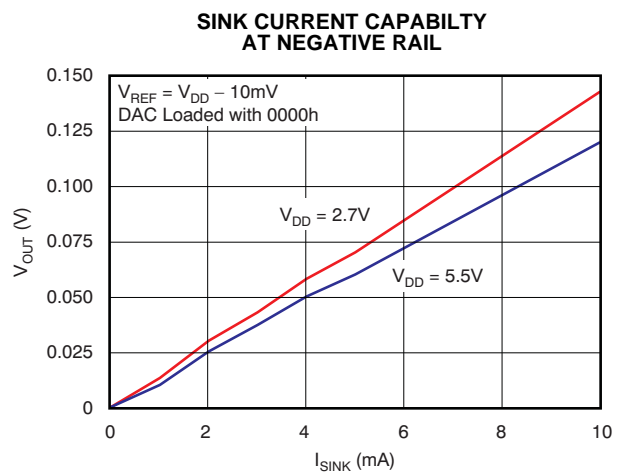

Figure 6.

TYPICAL CHARACTERISTICS: $V_{DD} = 5V$ (continued)

At $T_A = +25^\circ C$, unless otherwise noted.

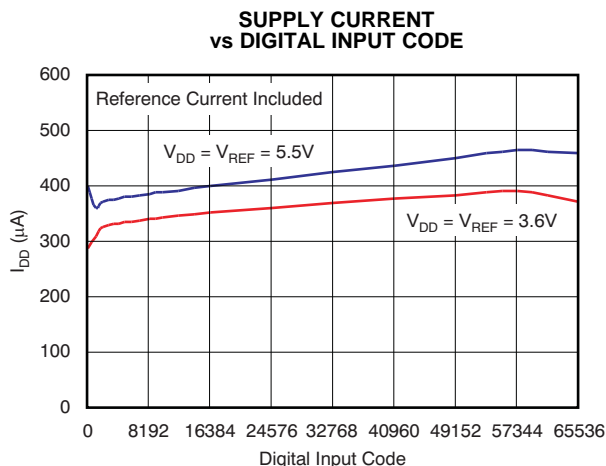

Figure 7.

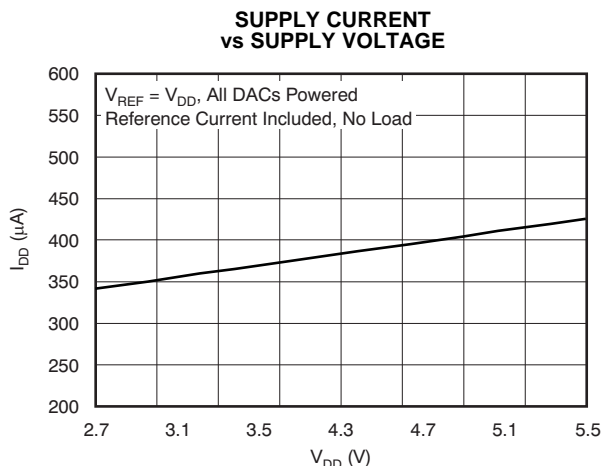

Figure 8.

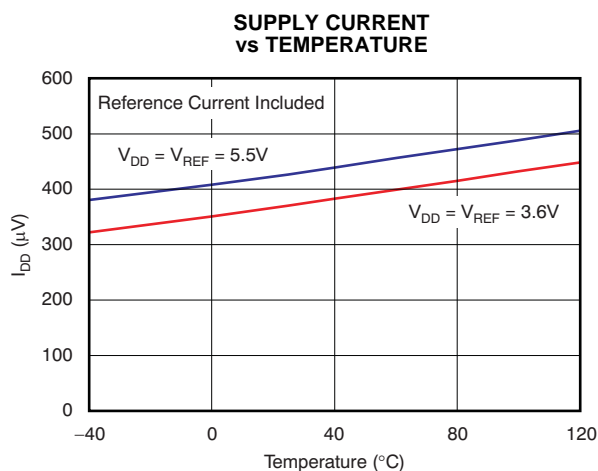

Figure 9.

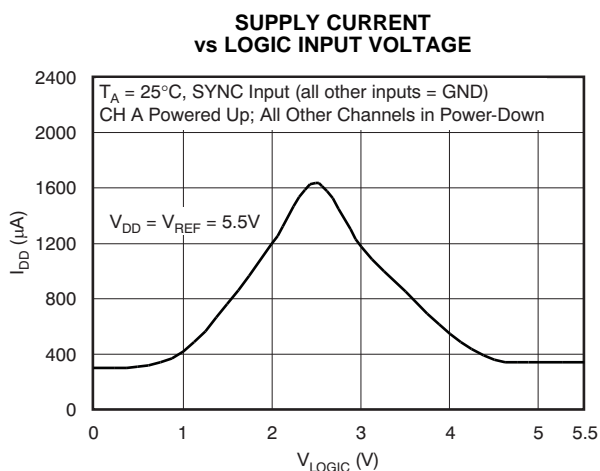

Figure 10.

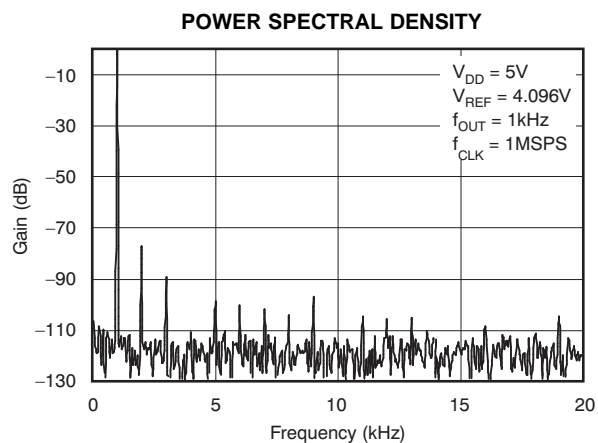

Figure 11.

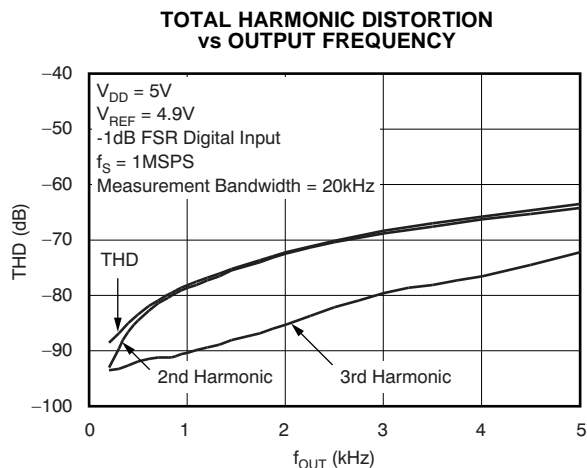

Figure 12.

TYPICAL CHARACTERISTICS: $V_{DD} = 5V$ (continued)

At $T_A = +25^\circ C$, unless otherwise noted.

SIGNAL-TO-NOISE RATIO vs OUTPUT FREQUENCY

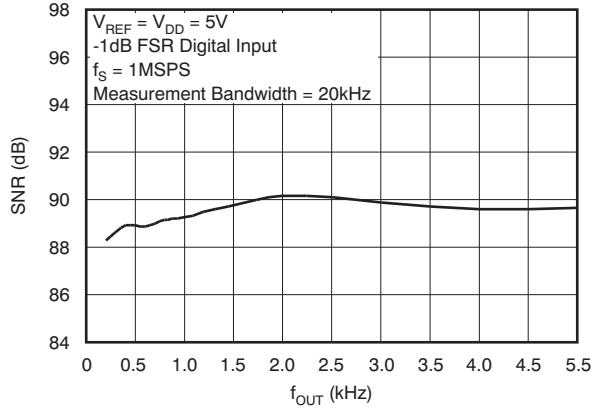

Figure 13.

OUTPUT NOISE DENSITY

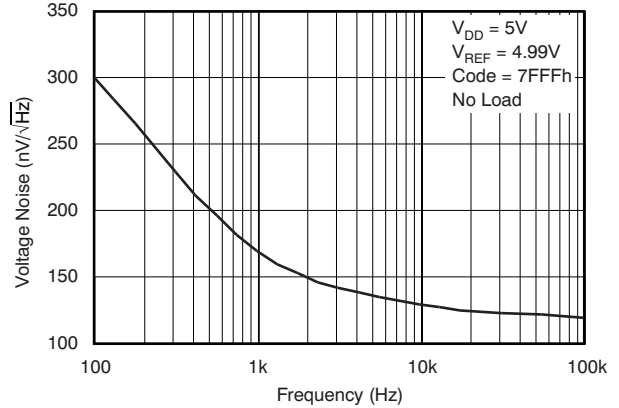

Figure 14.

FULL-SCALE SETTLING TIME: 5V RISING EDGE

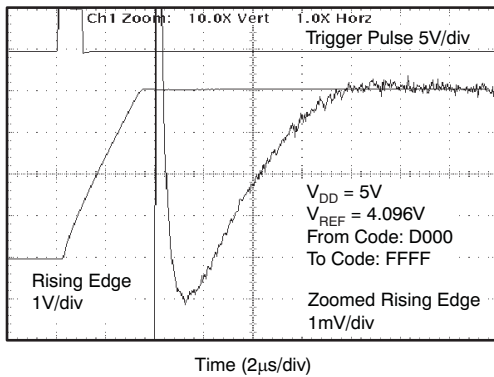

Figure 15.

FULL-SCALE SETTLING TIME: 5V FALLING EDGE

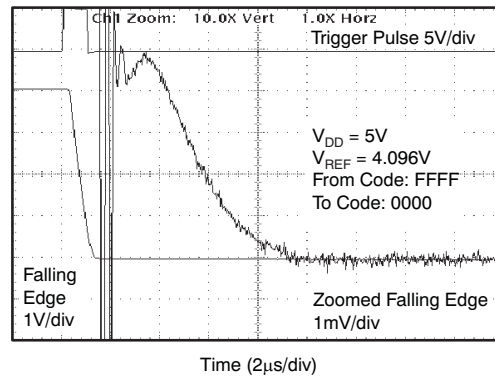

Figure 16.

HALF-SCALE SETTLING TIME: 5V RISING EDGE

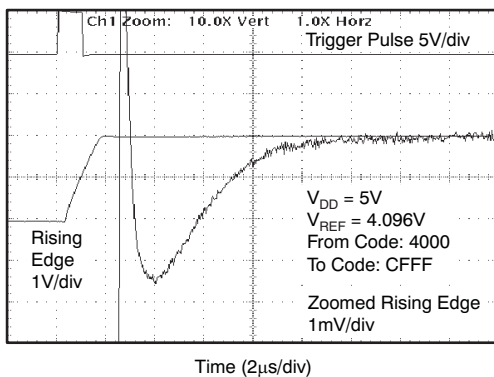

Figure 17.

HALF-SCALE SETTLING TIME: 5V FALLING EDGE

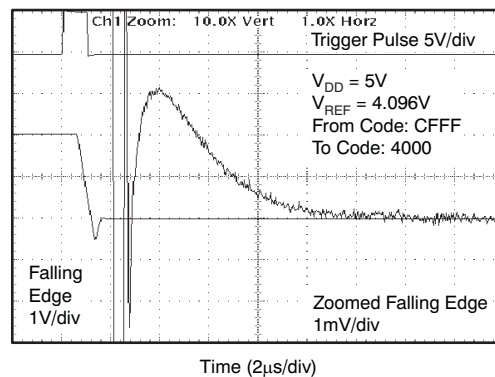
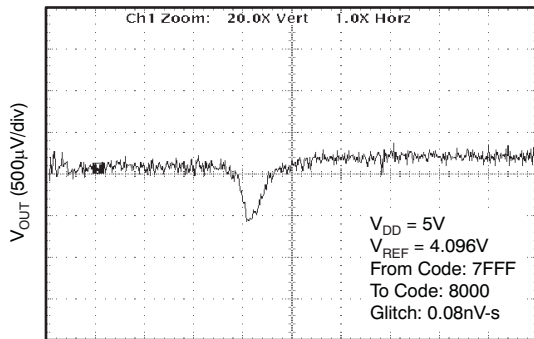

Figure 18.

TYPICAL CHARACTERISTICS: $V_{DD} = 5V$ (continued)

At $T_A = +25^\circ C$, unless otherwise noted.

GLITCH ENERGY: 5V, 1LSB STEP, RISING EDGE



Time (400ns/div)

Figure 19.

GLITCH ENERGY: 5V, 1LSB STEP, FALLING EDGE

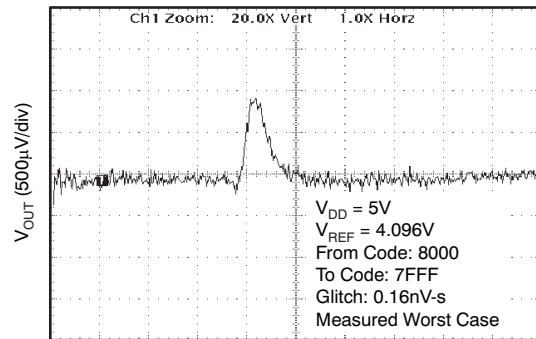

Time (400ns/div)

Figure 20.

GLITCH ENERGY: 5V, 16LSB STEP, RISING EDGE

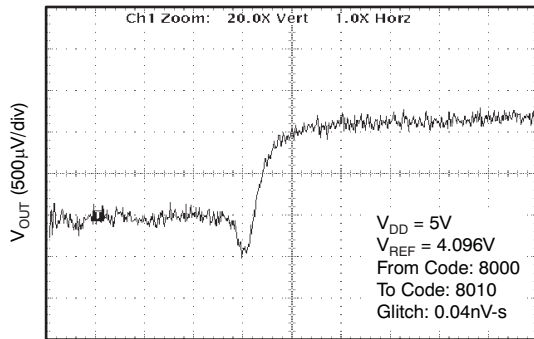

Time (400ns/div)

Figure 21.

GLITCH ENERGY: 5V, 16LSB STEP, FALLING EDGE

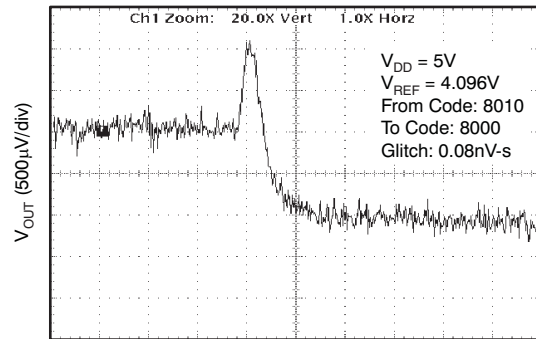

Time (400ns/div)

Figure 22.

GLITCH ENERGY: 5V, 256LSB STEP, RISING EDGE

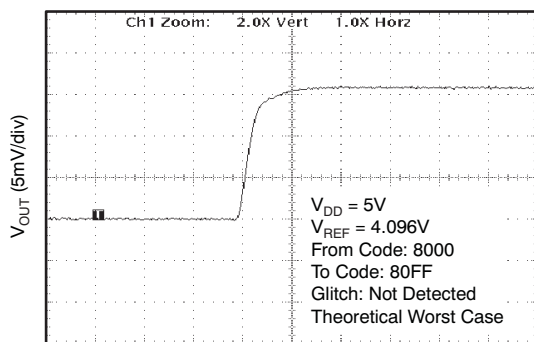

Time (400ns/div)

Figure 23.

GLITCH ENERGY: 5V, 256LSB STEP, FALLING EDGE

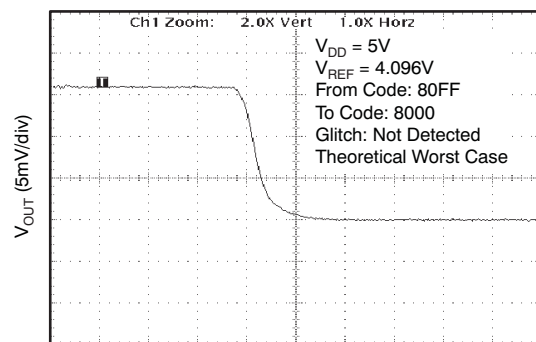

Time (400ns/div)

Figure 24.

TYPICAL CHARACTERISTICS: $V_{DD} = 2.7V$

At $T_A = +25^\circ C$, unless otherwise noted.

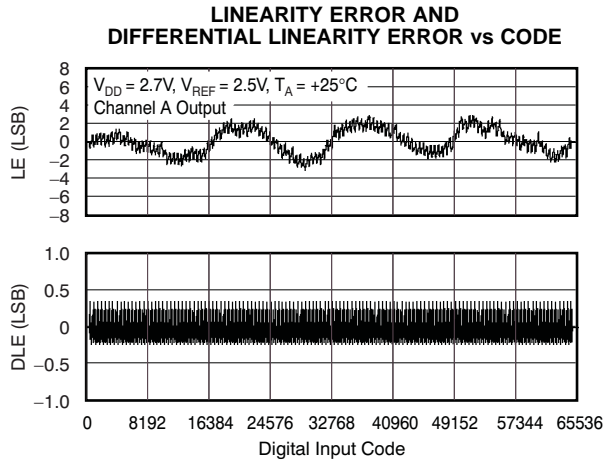

Figure 25.

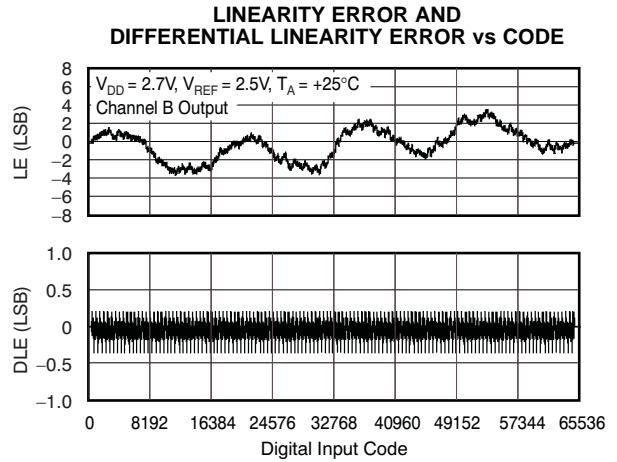

Figure 26.

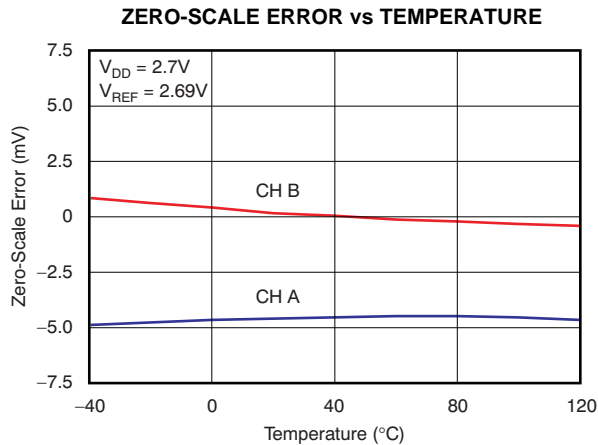

Figure 27.

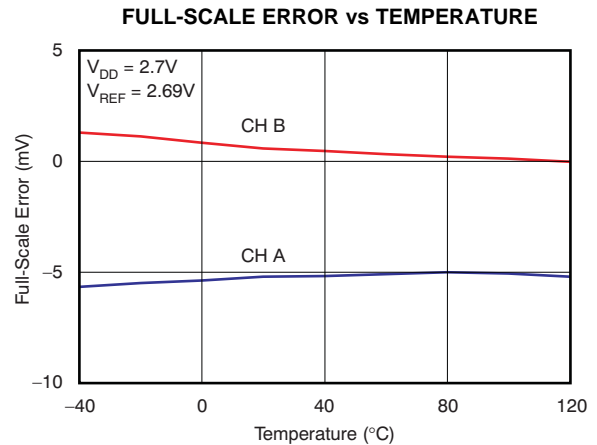

Figure 28.

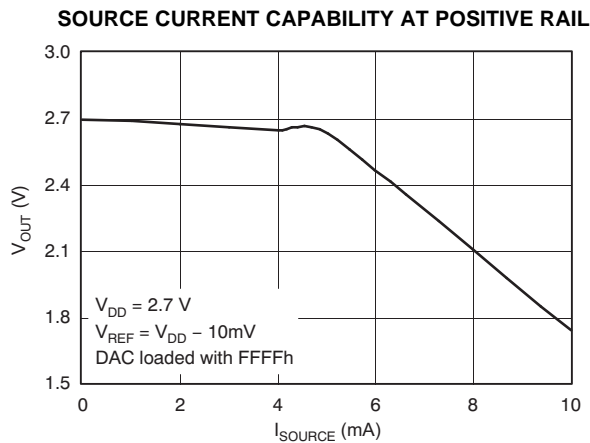

Figure 29.

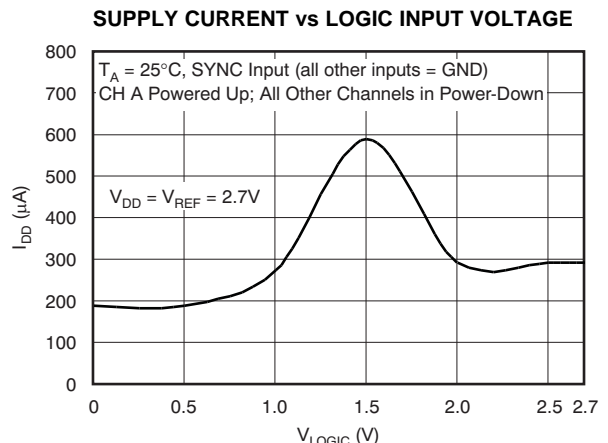
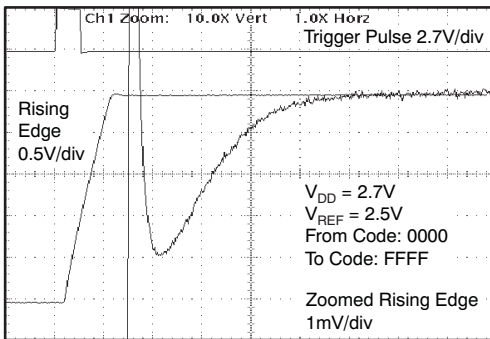

Figure 30.

TYPICAL CHARACTERISTICS: $V_{DD} = 2.7V$ (continued)

At $T_A = +25^\circ C$, unless otherwise noted.

FULL-SCALE SETTLING TIME: 2.7V RISING EDGE



Time (2µs/div)

Figure 31.

FULL-SCALE SETTLING TIME: 2.7V FALLING EDGE

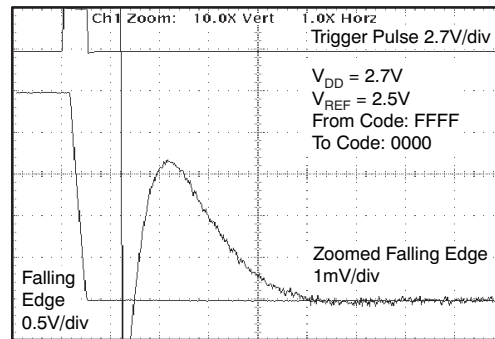

Time (2µs/div)

Figure 32.

HALF-SCALE SETTLING TIME: 2.7V RISING EDGE

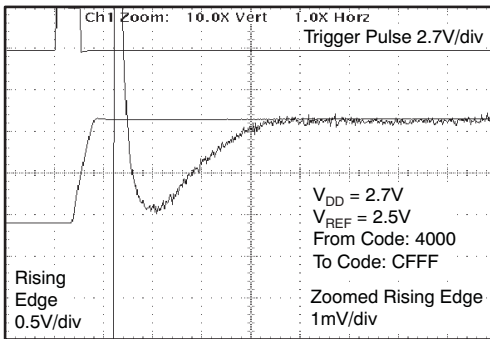

Time (2µs/div)

Figure 33.

HALF-SCALE SETTLING TIME: 2.7V FALLING EDGE

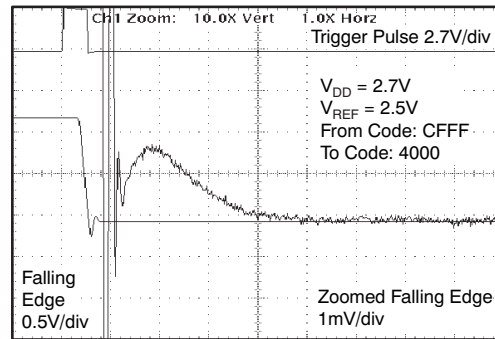

Time (2µs/div)

Figure 34.

GLITCH ENERGY: 2.7V, 1LSB STEP, RISING EDGE

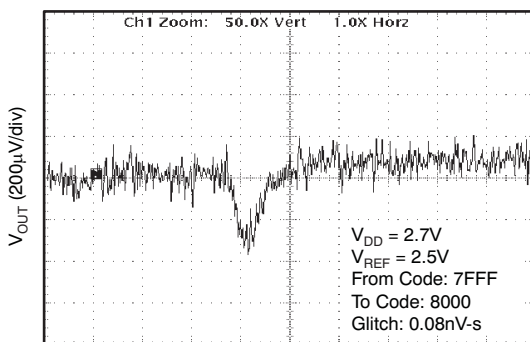

Time (400ns/div)

Figure 35.

GLITCH ENERGY: 2.7V, 1LSB STEP, FALLING EDGE

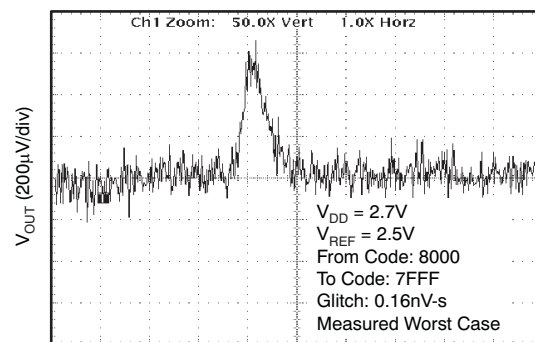

Time (400ns/div)

Figure 36.

TYPICAL CHARACTERISTICS: $V_{DD} = 2.7V$ (continued)

At $T_A = +25^\circ C$, unless otherwise noted.

GLITCH ENERGY: 2.7V, 16LSB STEP, RISING EDGE

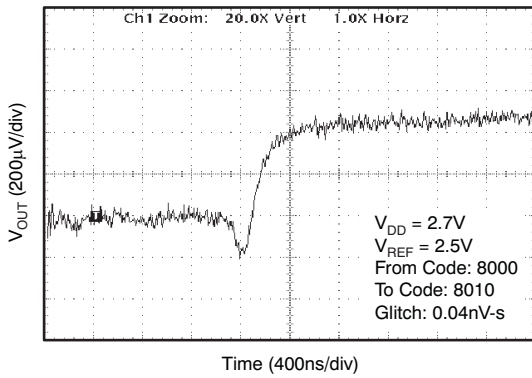

Figure 37.

GLITCH ENERGY: 2.7V, 16LSB STEP, FALLING EDGE

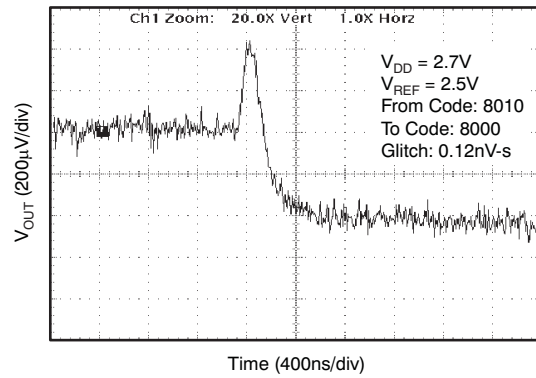

Figure 38.

GLITCH ENERGY: 2.7V, 256LSB STEP, RISING EDGE

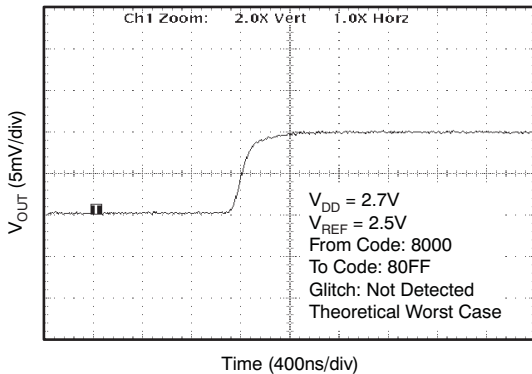

Figure 39.

GLITCH ENERGY: 2.7V, 256LSB STEP, FALLING EDGE

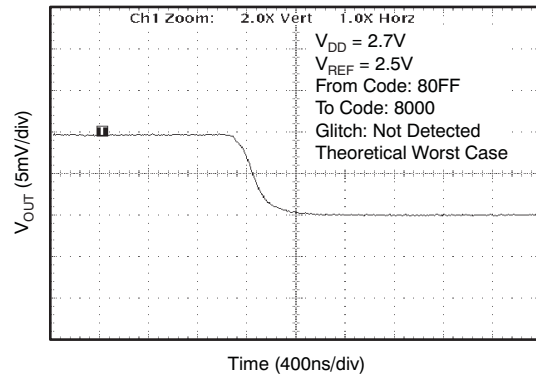

Figure 40.

THEORY OF OPERATION

DAC SECTION

The architecture of each channel of the DAC8552 consists of a resistor-string DAC followed by an output buffer amplifier. Figure 41 shows a simplified block diagram of the DAC architecture.

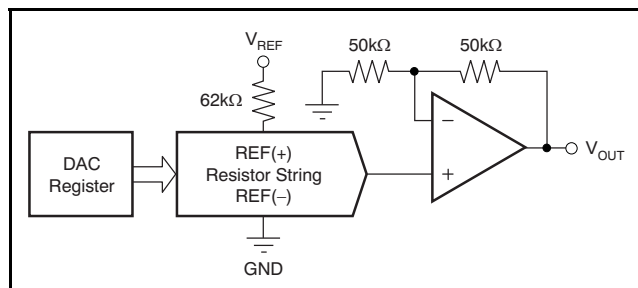

Figure 41. DAC8552 Architecture

The input coding for each device is unipolar straight binary, so the ideal output voltage is given by:

$$V_{OUT\ A,B} = V_{REF} \times \frac{D}{65536} \quad (1)$$

Where:

D = decimal equivalent of the binary code that is loaded to the DAC register; it can range from 0 to 65535.

$V_{OUT\ A,B}$ refers to channel A or B.

RESISTOR STRING

The resistor string section is shown in Figure 42. It is simply a divide-by-2 resistor followed by a string of resistors, each of value R. The code loaded into the DAC register determines at which node on the string the voltage is tapped off. This voltage is then applied to the output amplifier by closing one of the switches connecting the string to the amplifier.

OUTPUT AMPLIFIER

Each output buffer amplifier is capable of generating rail-to-rail voltages on its output which approaches an output range of 0V to V_{DD} (gain and offset errors must be taken into account). Each buffer is capable of driving a load of 2kΩ in parallel with 1000pF to GND. The source and sink capabilities of the output amplifier can be seen in the Typical Characteristics.

SERIAL INTERFACE

The DAC8552 uses a 3-wire serial interface (\overline{SYNC} , SCLK, and D_{IN}) that is compatible with SPI™, QSP™, and Microwire™ interface standards, as well as most DSPs. See the [Serial Write Operation Timing Diagram](#) for an example of a typical write sequence.

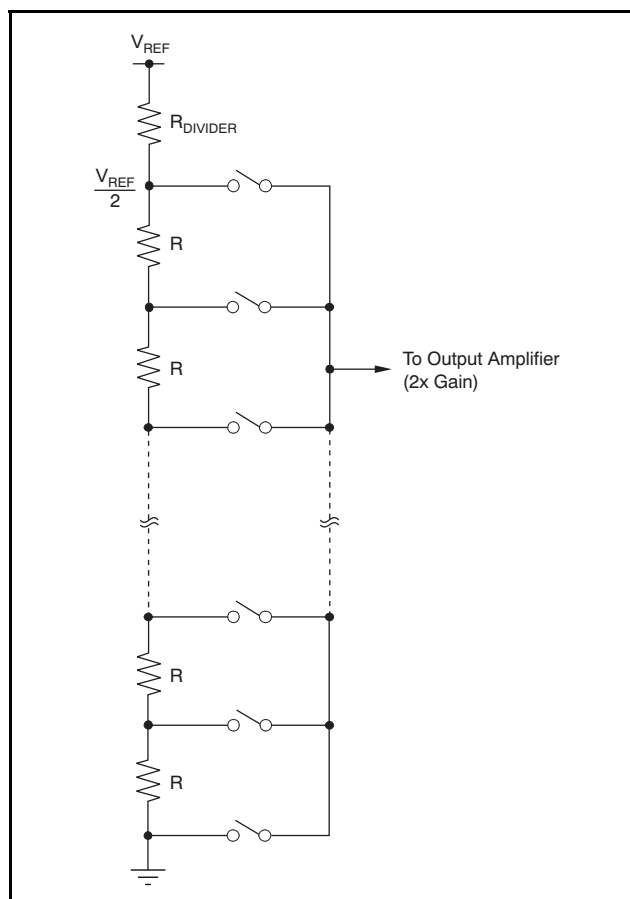

Figure 42. Resistor String

The write sequence begins by bringing the \overline{SYNC} line LOW. Data from the D_{IN} line are clocked into the 24-bit shift register on each falling edge of SCLK. The serial clock frequency can be as high as 30MHz, making the DAC8552 compatible with high speed DSPs. On the 24th falling edge of the serial clock, the last data bit is clocked into the shift register and the shift register is locked. Further clocking does not change the shift register data. Once 24 bits are locked into the shift register, the eight MSBs are used as control bits and the 16 LSBs are used as data. After receiving the 24th falling clock edge, the DAC8552 decodes the eight control bits and 16 data bits to perform the required function, without waiting for a \overline{SYNC} rising edge. A new SPI sequence starts at the next falling edge of \overline{SYNC} . A rising edge of \overline{SYNC} before the 24-bit sequence is complete resets the SPI interface; no data transfer occurs.

After the 24th falling edge of SCLK is received, the \overline{SYNC} line may be kept LOW or brought HIGH. In either case, the minimum delay time from the 24th falling SCLK edge to the next falling \overline{SYNC} edge must be met in order to properly begin the next

cycle. To assure the lowest power consumption of the device, care should be taken that the levels are as close to each rail as possible. (See the Typical Characteristics section for the [Supply Current vs Logic Input Voltage](#) transfer characteristic curve).

INPUT SHIFT REGISTER

The input shift register of the DAC8552 is 24 bits wide (shown in [Figure 43](#)) and is made up of eight control bits (DB16–DB23) and 16 data bits (DB0–DB15). The first two control bits (DB22 and DB23) are reserved and must be '0' for proper operation. LDA (DB20) and LD B (DB21) control the updating of each analog output with the specified 16-bit data value or power-down command. Bit DB19 is a *don't care* bit that does not affect the operation of the DAC8552, and can be '1' or '0'. The following control bit, Buffer Select (DB18), controls

the destination of the data (or power-down command) between DAC A and DAC B. The final two control bits, PD0 (DB16) and PD1 (DB17), select the power-down mode of one or both of the DAC channels. The four modes are normal mode or any one of three power-down modes. A more complete description of the operational modes of the DAC8552 can be found in the [Power-Down Modes](#) section. The remaining 16 bits of the 24-bit input word make up the data bits. These bits are transferred to the specified Data Buffer or DAC Register, depending on the command issued by the control byte, on the 24th falling edge of SCLK. See [Table 1](#) and [Table 2](#) for more information.

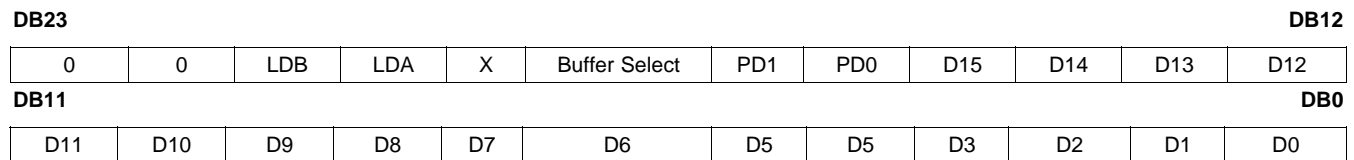

Figure 43. DAC8552 Data Input Register Format

Table 1. Control Matrix

D23	D22	D21	D20	D19	D18	D17	D16	D15	D14	D13–D0	DESCRIPTION
Reserved	Reserved	Load B	Load A	Don't Care	Buffer Select	PD1	PD0	MSB	MSB-1	MSB-2... LSB	
(Always Write 0)					0 = A, 1 = B						
0	0	0	0	X	#	0	0	Data			WR Buffer # w/Data
0	0	0	0	X	#	See Table 2		X			WR Buffer # w/Power-down Command
0	0	0	1	X	#	0	0	Data			WR Buffer # w/Data and Load DAC A
0	0	0	1	X	0	See Table 2		X			WR Buffer A w/Power-Down Command and LOAD DAC A (DAC A Powered Down)
0	0	0	1	X	1	See Table 2		X			WR Buffer B w/Power-Down Command and LOAD DAC A
0	0	1	0	X	#	0	0	Data			WR Buffer # w/Data and Load DAC B
0	0	1	0	X	0	See Table 2		X			WR Buffer A w/Power-Down Command and LOAD DAC B
0	0	1	0	X	1	See Table 2		X			WR Buffer B w/Power-Down Command and LOAD DAC B (DAC B Powered Down)
0	0	1	1	X	#	0	0	Data			WR Buffer # w/Data and Load DACs A and B
0	0	1	1	X	0	See Table 2		X			WR Buffer A w/Power-Down Command and Load DACs A and B (DAC A Powered Down)
0	0	1	1	X	1	See Table 2		X			WR Buffer B w/Power-Down Command and Load DACs A and B (DAC B Powered Down)

Table 2. Power-Down Commands

D17	D16	OUTPUT IMPEDANCE POWER DOWN COMMANDS
PD1	PD0	
0	1	1kΩ
1	0	100kΩ
1	1	High Impedance

SYNC INTERRUPT

In a normal write sequence, the $\overline{\text{SYNC}}$ line is kept LOW for at least 24 falling edges of SCLK and the addressed DAC register is updated on the 24th falling edge. However, if $\overline{\text{SYNC}}$ is brought HIGH before the 24th falling edge, it acts as an interrupt to the write sequence; the shift register is reset and the write sequence is discarded. Neither an update of the data buffer contents, DAC register contents nor a change in the operating mode occurs, as shown in Figure 45.

POWER-ON RESET

The DAC8552 contains a power-on reset circuit that controls the output voltage during power-up. Upon power-up, the DAC registers are filled with zeros and the output voltages are set to zero-scale; they remain that way until a valid write sequence and load command are made to the respective DAC channel. The power-on reset is useful in applications where it is important to know the state of the output of each DAC output while the device is in the process of powering up.

No device pin should be brought high before power is applied to the device.

POWER-DOWN MODES

The DAC8552 uses four modes of operation. These modes are accessed by setting two bits (PD1 and PD0) in the control register to one or both DACs. Table 3 shows how the state of the bits correspond to the register and perform a mode of operation on each channel of the device. (Each DAC channel can be powered down simultaneously or independently of each other. Power-down occurs after proper data is written into PD0 and PD1 and a Load command occurs.) See the Operation Examples section for additional information.

When both bits are set to '0', the device works normally with a typical power consumption of 450µA at 5V. For the three power-down modes, however, the supply current falls to 700nA at 5V (400nA at

3V). Not only does the supply current fall, but the output stage is also internally switched from the output of the amplifier to a resistor network of known values. This configuration has the advantage that the output impedance of the device is known while it is in power-down mode. There are three different options for power-down: The output is connected internally to GND through a 1kΩ resistor, a 100kΩ resistor, or it is left open-circuited (High-Impedance). The output stage is illustrated in Figure 44.

Table 3. Operating Modes

PD1 (DB17)	PD0 (DB16)	OPERATING MODE
0	0	Normal Operation
—	—	Power-down modes
0	1	Output typically 1kΩ to GND
1	0	Output typically 100kΩ to GND
1	1	High impedance

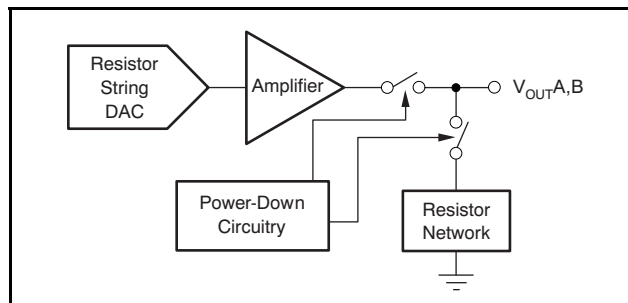

Figure 44. Output Stage During Power-Down (High Impedance)

All analog circuitry is shut down when the power-down mode is activated. Each DAC will exit power-down when PD0 and PD1 are set to '0', new data is written to the Data Buffer, and the DAC channel receives a Load command. The time to exit power-down is typically 2.5µs for $V_{DD} = 5V$ and 5µs for $V_{DD} = 3V$ (see the Typical Characteristics).

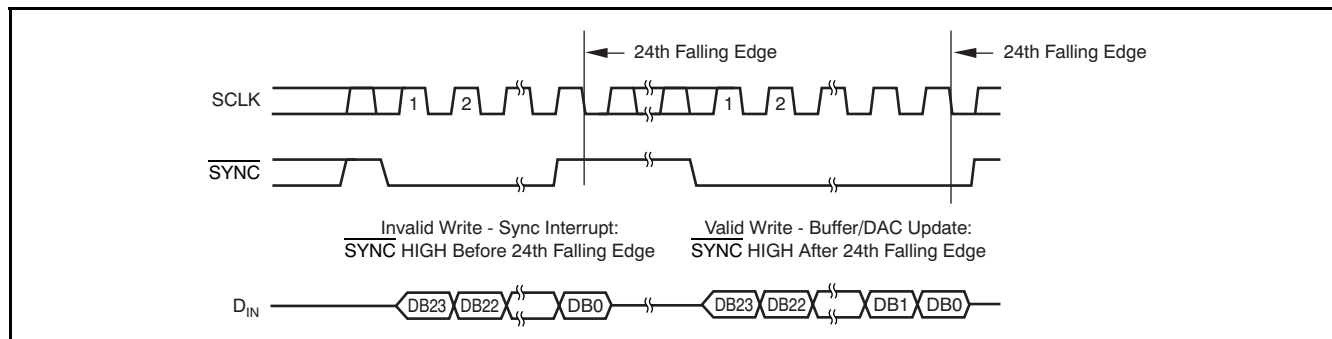

Figure 45. Interrupt and Valid $\overline{\text{SYNC}}$ Timing

OPERATION EXAMPLES

Example 1: Write to Data Buffer A Through Buffer B; Load DAC A Through DAC B Simultaneously

- 1st — Write to Data Buffer A:

Reserved	Reserved	LDB	LDA	DC	Buffer Select	PD1	PD0	DB15	—	DB1	DB0
0	0	0	0	X	0	0	0	D15	—	D1	D0

- 2nd — Write to Data Buffer B and Load DAC A and DAC B simultaneously:

Reserved	Reserved	LDB	LDA	DC	Buffer Select	PD1	PD0	DB15	—	DB1	DB0
0	0	1	1	X	1	0	0	D15	—	D1	D0

The DAC A and DAC B analog outputs simultaneously settle to the specified values upon completion of the 2nd write sequence. (The *Load* command moves the digital data from the data buffer to the DAC register at which time the conversion takes place and the analog output is updated. *Completion* occurs on the 24th falling SCLK edge after $\overline{\text{SYNC LOW}}$.)

Example 2: Load New Data to DAC A and DAC B Sequentially

- 1st — Write to Data Buffer A and Load DAC A: DAC A output settles to specified value upon completion:

Reserved	Reserved	LDB	LDA	DC	Buffer Select	PD1	PD0	DB15	—	DB1	DB0
0	0	0	1	X	0	0	0	D15	—	D1	D0

- 2nd — Write to Data Buffer B and Load DAC B: DAC B output settles to specified value upon completion:

Reserved	Reserved	LDB	LDA	DC	Buffer Select	PD1	PD0	DB15	—	DB1	DB0
0	0	1	0	X	1	0	0	D15	—	D1	D0

After completion of the 1st write cycle, the DAC A analog output settles to the voltage specified; upon completion of write cycle 2, the DAC B analog output settles.

Example 3: Power-Down DAC A to 1k Ω and Power-Down DAC B to 100k Ω Simultaneously

- 1st — Write power-down command to Data Buffer A:

Reserved	Reserved	LDB	LDA	DC	Buffer Select	PD1	PD0	DB15	—	DB1	DB0
0	0	0	0	X	0	0	1	Don't Care			

- 2nd — Write power-down command to Data Buffer B and Load DAC A and DAC B simultaneously:

Reserved	Reserved	LDB	LDA	DC	Buffer Select	PD1	PD0	DB15	—	DB1	DB0
0	0	1	1	X	1	1	0	Don't Care			

The DAC A and DAC B analog outputs simultaneously power-down to each respective specified mode upon completion of the 2nd write sequence.

Example 4: Power-Down DAC A and DAC B to High-Impedance Sequentially:

- 1st — Write power-down command to Data Buffer A and Load DAC A: DAC A output = Hi-Z:

Reserved	Reserved	LDB	LDA	DC	Buffer Select	PD1	PD0	DB15	—	DB1	DB0
0	0	0	1	X	0	1	1	Don't Care			

- 2nd — Write power-down command to Data Buffer B and Load DAC B: DAC B output = Hi-Z:

Reserved	Reserved	LDB	LDA	DC	Buffer Select	PD1	PD0	DB15	—	DB1	DB0
0	0	1	0	X	1	1	1	Don't Care			

The DAC A and DAC B analog outputs sequentially power-down to high-impedance upon completion of the 1st and 2nd write sequences, respectively.

MICROPROCESSOR INTERFACING

DAC8552 to 8051 INTERFACE

Figure 46 shows a serial interface between the DAC8552 and a typical 8051-type microcontroller. The setup for the interface is as follows: TXD of the 8051 drives SCLK of the DAC8552, while RXD drives the serial data line of the device. The SYNC signal is derived from a bit-programmable pin on the port of the 8051. In this case, port line P3.3 is used. When data are to be transmitted to the DAC8552, P3.3 is taken LOW. The 8051 transmits data in 8-bit bytes; thus, only eight falling clock edges occur in the transmit cycle. To load data to the DAC, P3.3 is left LOW after the first eight bits are transmitted, then a second and third write cycle are initiated to transmit the remaining data. P3.3 is taken HIGH following the completion of the third write cycle. The 8051 outputs the serial data in a format that presents the LSB first, while the DAC8552 requires its data with the MSB as the first bit received. The 8051 transmit routine must therefore take this into account, and *mirror* the data as needed.

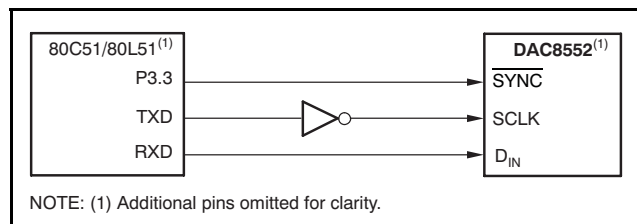

Figure 46. DAC8552 to 80C51/80L51 Interface

DAC8552 to Microwire INTERFACE

Figure 47 shows an interface between the DAC8552 and any Microwire-compatible device. Serial data are shifted out on the falling edge of the serial clock and clocked into the DAC8552 on the rising edge of the SK signal.

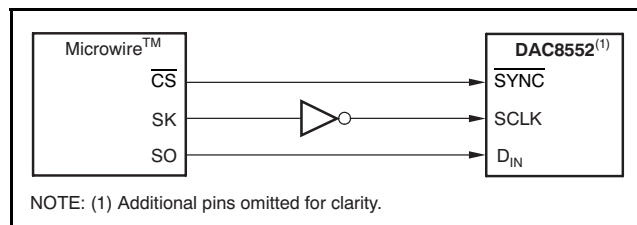

Figure 47. DAC8552 to Microwire Interface

DAC8552 to 68HC11 INTERFACE

Figure 48 shows a serial interface between the DAC8552 and the 68HC11 microcontroller. SCK of the 68HC11 drives the SCLK of the DAC8552, while the MOSI output drives the serial data line of the DAC. The SYNC signal is derived from a port line (PC7), similar to the 8051 diagram.

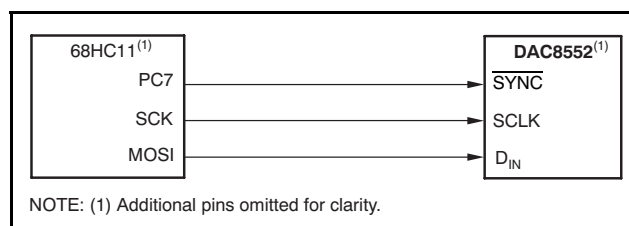

Figure 48. DAC8552 to 68HC11 Interface

The 68HC11 should be configured so that its CPOL bit is '0' and its CPHA bit is '1'. This configuration causes data appearing on the MOSI output to be valid on the falling edge of SCK. When data are being transmitted to the DAC, the SYNC line is held LOW (PC7). Serial data from the 68HC11 are transmitted in 8-bit bytes with only eight falling clock edges occurring in the transmit cycle. (Data are transmitted MSB first.) In order to load data to the DAC8552, PC7 is left LOW after the first eight bits are transferred, then a second and third serial write operation are performed to the DAC. PC7 is taken HIGH at the end of this procedure.

DAC8552 to TMS320 DSP INTERFACE

Figure 49 shows the connections between the DAC8552 and a TMS320 digital signal processor. By decoding the FSX signal, multiple DAC8552s can be connected to a single serial port of the DSP.

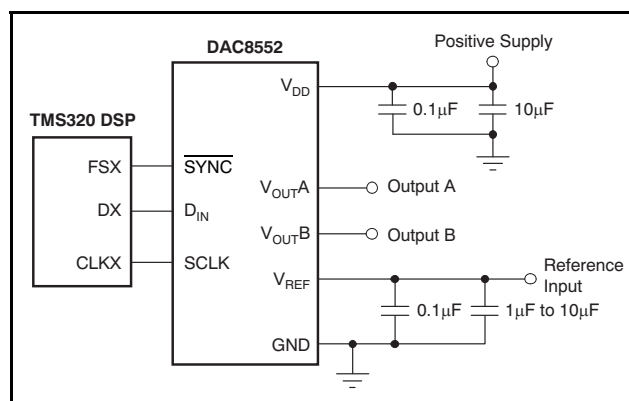

Figure 49. DAC8552 to TMS320 DSP

APPLICATION INFORMATION

CURRENT CONSUMPTION

The DAC8552 typically consumes 170 μ A at $V_{DD} = 5$ V and 155 μ A at $V_{DD} = 2.7$ V for each active channel, excluding reference current consumption. Additional current consumption can occur at the digital inputs if $V_{IH} \ll V_{DD}$. For most efficient power operation, CMOS logic levels are recommended at the digital input to the DAC.

In power-down mode, typical current consumption is 700nA. A delay time of 10ms to 20ms after a power-down command is issued to the DAC is typically sufficient for the power-down current to drop below 10 μ A.

DRIVING RESISTIVE AND CAPACITIVE LOADS

The DAC8552 output stage is capable of driving loads of up to 1000pF while remaining stable. Within the offset and gain error margins, the DAC8552 can operate rail-to-rail when driving a capacitive load. Resistive loads of 2k Ω can be driven by the DAC8552 while achieving good load regulation. When the outputs of the DAC are driven to the positive rail under resistive loading, the PMOS transistor of each Class-AB output stage can enter into the linear region. When this scenario occurs, the added IR voltage drop deteriorates the linearity performance of the DAC. This deterioration only occurs within approximately the top 100mV of the DACs output voltage characteristic. Under resistive loading conditions, good linearity is preserved as long as the output voltage is at least 100mV below the V_{DD} voltage.

CROSSTALK AND AC PERFORMANCE

The DAC8552 architecture uses separate resistor strings for each DAC channel in order to achieve ultra-low crosstalk performance. dc crosstalk seen at one channel during a full-scale change on the neighboring channel is typically less than 0.5 LSBs. The ac crosstalk measured (for a full-scale, 1kHz sine wave output generated at one channel, and measured at the remaining output channel) is typically under –100dB.

In addition, the DAC8552 can achieve typical ac performance of 96dB signal-to-noise ratio (SNR) and –85dB total harmonic distortion (THD), making the DAC8552 a solid choice for applications requiring high SNR at output frequencies at or below 10kHz.

OUTPUT VOLTAGE STABILITY

The DAC8552 exhibits excellent temperature stability of 5ppm/ $^{\circ}$ C typical output voltage drift over the specified temperature range of the device. This stability enables the output voltage of each channel to stay within a $\pm 25\mu$ V window for a $\pm 1^{\circ}$ C ambient temperature change.

Good power-supply rejection ratio (PSRR) performance reduces supply noise present on V_{DD} from appearing at the outputs. Combined with good dc noise performance and true 16-bit differential linearity, the DAC8552 becomes an ideal choice for closed-loop control applications.

SETTLING TIME AND OUTPUT GLITCH PERFORMANCE

The DAC8552 settles to $\pm 0.003\%$ of its full-scale range within 10 μ s, driving a 200pF, 2k Ω load. For good settling performance, the outputs should not approach the top and bottom rails. Small signal settling time is under 1 μ s, enabling data update rates exceeding 1MSPS for small code changes.

Many applications are sensitive to undesired transient signals such as glitch. The DAC8552 has a proprietary, ultra-low glitch architecture addressing such applications. Code-to-code glitches rarely exceed 1mV and they last under 0.3 μ s. Typical glitch energy is an outstanding 0.15nV-s. Theoretical worst-case glitch should occur during a 256LSB step, but it is so low, it cannot be detected.

DIFFERENTIAL AND INTEGRAL NONLINEARITY

The DAC8552 uses precision, thin-film resistors to achieve monotonicity and good linearity. Typical linearity error is ± 4 LSBs, with a ± 0.3 mV error for a 5V range. Differential linearity is typically ± 0.35 LSBs, with a $\pm 27\mu$ V error for a consecutive code change.

USING REF02 AS A POWER SUPPLY FOR DAC8552

Due to the extremely low supply current required by the DAC8552, a possible configuration is to use a REF02 +5V precision voltage reference to supply the required voltage to the DAC8552 supply input as well as the reference input, as shown in Figure 50.

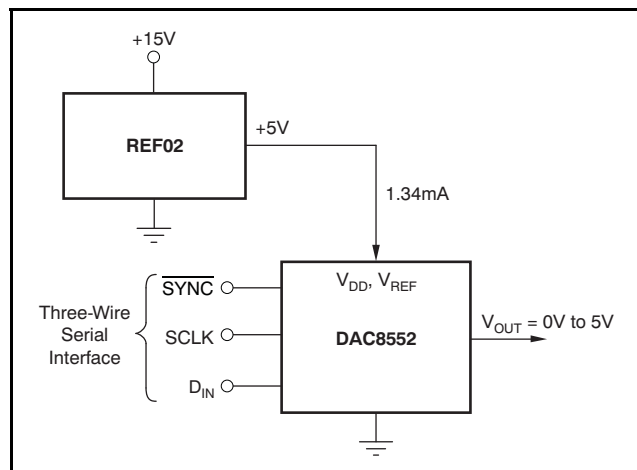

Figure 50. REF02 as a Power Supply to the DAC8552

This configuration is especially useful if the power supply is quite noisy or if the system supply voltages are at some value other than 5V. The REF02 will output a steady supply voltage for the DAC8552. If the REF02 is used, the current it needs to supply to

the DAC8552 is 340 μ A typical and 500 μ A max for $V_{DD} = 5V$. When a DAC output is loaded, the REF02 also needs to supply the current to the load. The typical current required (with a 5k Ω load on a given DAC output) is:

$$340\mu\text{A} + (5V/5k\Omega) = 1.34\text{mA}$$

BIPOLAR OPERATION USING THE DAC8552

The DAC8552 has been designed for single-supply operation but a bipolar output range is also possible using the circuit in Figure 51. The circuit shown here gives an output voltage range of $\pm V_{REF}$. Rail-to-rail operation at the amplifier output is achievable using an amplifier such as the OPA703, as shown in Figure 51.

The output voltage for any input code can be calculated as follows:

$$V_{OUT\ A, B} = \left[V_{REF} \times \left(\frac{D}{65536} \right) \times \left(\frac{R_1 + R_2}{R_1} \right) - V_{REF} \times \left(\frac{R_2}{R_1} \right) \right] \quad (2)$$

where D represents the input code in decimal (0–65535).

With $V_{REF} = 5V$, $R_1 = R_2 = 10k\Omega$.

$$V_{OUT\ A, B} = \left(\frac{10 \times D}{65536} \right) - 5V \quad (3)$$

Using this example, an output voltage range of $\pm 5V$ with 0000h corresponding to a $-5V$ output and FFFFh corresponding to a $5V$ output can be achieved. Similarly, using $V_{REF} = 2.5V$, a $\pm 2.5V$ output voltage range can be achieved.

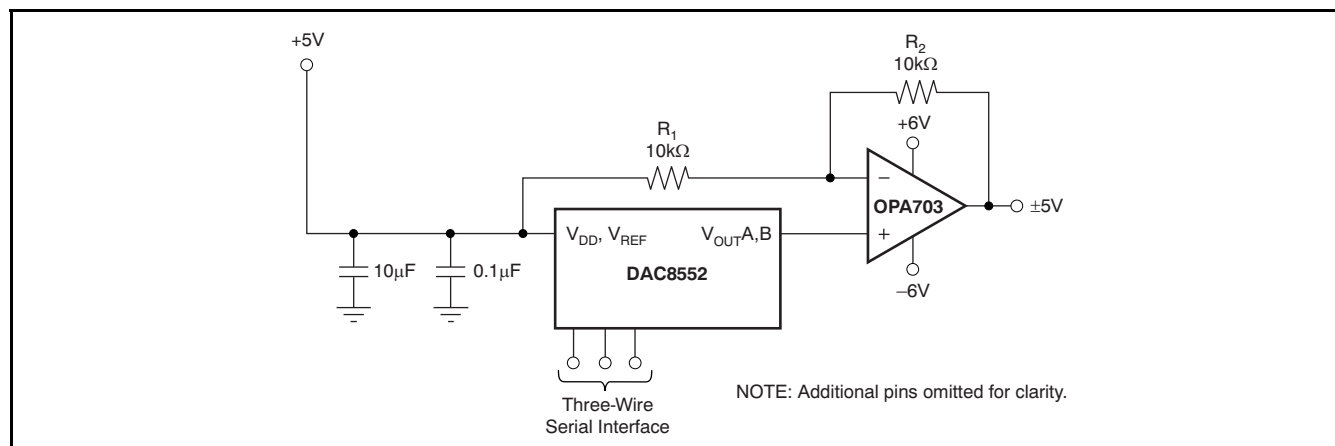

Figure 51. Bipolar Operation with the DAC8552

LAYOUT

A precision analog component requires careful layout, adequate bypassing, and clean, well-regulated power supplies.

The DAC8552 offers single-supply operation, and it will often be used in close proximity with digital logic, microcontrollers, microprocessors, and digital signal processors. The more digital logic present in the design and the higher the switching speed, the more difficult it is to keep digital noise from appearing at the output.

Due to the single ground pin of the DAC8552, all return currents, including digital and analog return currents for the DAC, must flow through a single point. Ideally, GND would be connected directly to an analog ground plane. This plane would be separate from the ground connection for the digital components until they are connected at the power entry point of the system.

The power applied to V_{DD} should be well-regulated and low-noise. Switching power supplies and dc/dc converters will often have high-frequency glitches or spikes riding on the output voltage. In addition, digital components can create similar high-frequency spikes. This noise can easily couple into the DAC output voltage through various paths between the power connections and analog output.

As with the GND connection, V_{DD} should be connected to a positive power-supply plane or trace that is separate from the connection for digital logic until they are connected at the power entry point. In addition, a 1 μ F to 10 μ F capacitor in parallel with a 0.1 μ F bypass capacitor is strongly recommended. In some situations, additional bypassing may be required, such as a 100 μ F electrolytic capacitor or even a *Pi* filter made up of inductors and capacitors—all designed to essentially low-pass filter the supply, removing the high-frequency noise.

PACKAGING INFORMATION

Orderable Device	Status ⁽¹⁾	Package Type	Package Drawing	Pins	Package Qty	Eco Plan ⁽²⁾	Lead/Ball Finish	MSL Peak Temp ⁽³⁾
DAC8552IDGKR	ACTIVE	MSOP	DGK	8	2500	Green (RoHS & no Sb/Br)	CU NIPDAU	Level-1-260C-UNLIM
DAC8552IDGKRG4	ACTIVE	MSOP	DGK	8	2500	Green (RoHS & no Sb/Br)	CU NIPDAU	Level-1-260C-UNLIM
DAC8552IDGKT	ACTIVE	MSOP	DGK	8	250	Green (RoHS & no Sb/Br)	CU NIPDAU	Level-1-260C-UNLIM
DAC8552IDGKTG4	ACTIVE	MSOP	DGK	8	250	Green (RoHS & no Sb/Br)	CU NIPDAU	Level-1-260C-UNLIM

⁽¹⁾ The marketing status values are defined as follows:

ACTIVE: Product device recommended for new designs.

LIFEBUY: TI has announced that the device will be discontinued, and a lifetime-buy period is in effect.

NRND: Not recommended for new designs. Device is in production to support existing customers, but TI does not recommend using this part in a new design.

PREVIEW: Device has been announced but is not in production. Samples may or may not be available.

OBSOLETE: TI has discontinued the production of the device.

⁽²⁾ Eco Plan - The planned eco-friendly classification: Pb-Free (RoHS), Pb-Free (RoHS Exempt), or Green (RoHS & no Sb/Br) - please check <http://www.ti.com/productcontent> for the latest availability information and additional product content details.

TBD: The Pb-Free/Green conversion plan has not been defined.

Pb-Free (RoHS): TI's terms "Lead-Free" or "Pb-Free" mean semiconductor products that are compatible with the current RoHS requirements for all 6 substances, including the requirement that lead not exceed 0.1% by weight in homogeneous materials. Where designed to be soldered at high temperatures, TI Pb-Free products are suitable for use in specified lead-free processes.

Pb-Free (RoHS Exempt): This component has a RoHS exemption for either 1) lead-based flip-chip solder bumps used between the die and package, or 2) lead-based die adhesive used between the die and leadframe. The component is otherwise considered Pb-Free (RoHS compatible) as defined above.

Green (RoHS & no Sb/Br): TI defines "Green" to mean Pb-Free (RoHS compatible), and free of Bromine (Br) and Antimony (Sb) based flame retardants (Br or Sb do not exceed 0.1% by weight in homogeneous material)

⁽³⁾ MSL, Peak Temp. -- The Moisture Sensitivity Level rating according to the JEDEC industry standard classifications, and peak solder temperature.

Important Information and Disclaimer:The information provided on this page represents TI's knowledge and belief as of the date that it is provided. TI bases its knowledge and belief on information provided by third parties, and makes no representation or warranty as to the accuracy of such information. Efforts are underway to better integrate information from third parties. TI has taken and continues to take reasonable steps to provide representative and accurate information but may not have conducted destructive testing or chemical analysis on incoming materials and chemicals. TI and TI suppliers consider certain information to be proprietary, and thus CAS numbers and other limited information may not be available for release.

In no event shall TI's liability arising out of such information exceed the total purchase price of the TI part(s) at issue in this document sold by TI to Customer on an annual basis.

TAPE AND REEL INFORMATION



QUADRANT ASSIGNMENTS FOR PIN 1 ORIENTATION IN TAPE



*All dimensions are nominal

Device	Package Type	Package Drawing	Pins	SPQ	Reel Diameter (mm)	Reel Width W1 (mm)	A0 (mm)	B0 (mm)	K0 (mm)	P1 (mm)	W (mm)	Pin1 Quadrant
DAC8552IDGKR	MSOP	DGK	8	2500	330.0	12.4	5.3	3.4	1.4	8.0	12.0	Q1
DAC8552IDGKT	MSOP	DGK	8	250	330.0	12.4	5.3	3.4	1.4	8.0	12.0	Q1

TAPE AND REEL BOX DIMENSIONS



*All dimensions are nominal

Device	Package Type	Package Drawing	Pins	SPQ	Length (mm)	Width (mm)	Height (mm)
DAC8552IDGKR	MSOP	DGK	8	2500	346.0	346.0	29.0
DAC8552IDGKT	MSOP	DGK	8	250	346.0	346.0	29.0

DGK (S-PDSO-G8)

PLASTIC SMALL-OUTLINE PACKAGE

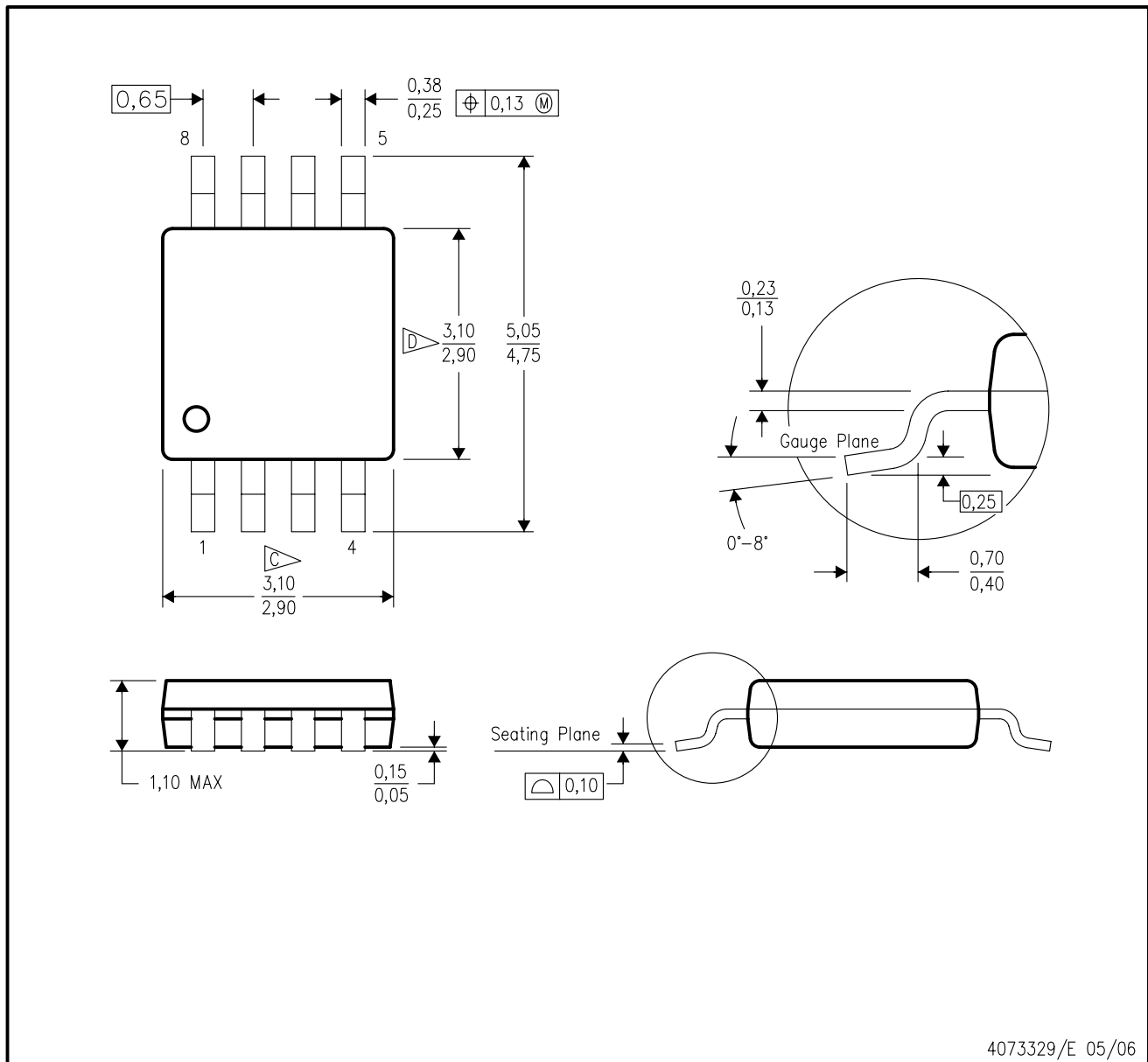

- NOTES:
- A. All linear dimensions are in millimeters.
 - B. This drawing is subject to change without notice.
 - C. Body length does not include mold flash, protrusions, or gate burrs. Mold flash, protrusions, or gate burrs shall not exceed 0.15 per end.
 - D. Body width does not include interlead flash. Interlead flash shall not exceed 0.50 per side.
 - E. Falls within JEDEC MO-187 variation AA, except interlead flash.

IMPORTANT NOTICE

Texas Instruments Incorporated and its subsidiaries (TI) reserve the right to make corrections, modifications, enhancements, improvements, and other changes to its products and services at any time and to discontinue any product or service without notice. Customers should obtain the latest relevant information before placing orders and should verify that such information is current and complete. All products are sold subject to TI's terms and conditions of sale supplied at the time of order acknowledgment.

TI warrants performance of its hardware products to the specifications applicable at the time of sale in accordance with TI's standard warranty. Testing and other quality control techniques are used to the extent TI deems necessary to support this warranty. Except where mandated by government requirements, testing of all parameters of each product is not necessarily performed.

TI assumes no liability for applications assistance or customer product design. Customers are responsible for their products and applications using TI components. To minimize the risks associated with customer products and applications, customers should provide adequate design and operating safeguards.

TI does not warrant or represent that any license, either express or implied, is granted under any TI patent right, copyright, mask work right, or other TI intellectual property right relating to any combination, machine, or process in which TI products or services are used. Information published by TI regarding third-party products or services does not constitute a license from TI to use such products or services or a warranty or endorsement thereof. Use of such information may require a license from a third party under the patents or other intellectual property of the third party, or a license from TI under the patents or other intellectual property of TI.

Reproduction of TI information in TI data books or data sheets is permissible only if reproduction is without alteration and is accompanied by all associated warranties, conditions, limitations, and notices. Reproduction of this information with alteration is an unfair and deceptive business practice. TI is not responsible or liable for such altered documentation. Information of third parties may be subject to additional restrictions.

Resale of TI products or services with statements different from or beyond the parameters stated by TI for that product or service voids all express and any implied warranties for the associated TI product or service and is an unfair and deceptive business practice. TI is not responsible or liable for any such statements.

TI products are not authorized for use in safety-critical applications (such as life support) where a failure of the TI product would reasonably be expected to cause severe personal injury or death, unless officers of the parties have executed an agreement specifically governing such use. Buyers represent that they have all necessary expertise in the safety and regulatory ramifications of their applications, and acknowledge and agree that they are solely responsible for all legal, regulatory and safety-related requirements concerning their products and any use of TI products in such safety-critical applications, notwithstanding any applications-related information or support that may be provided by TI. Further, Buyers must fully indemnify TI and its representatives against any damages arising out of the use of TI products in such safety-critical applications.

TI products are neither designed nor intended for use in military/aerospace applications or environments unless the TI products are specifically designated by TI as military-grade or "enhanced plastic." Only products designated by TI as military-grade meet military specifications. Buyers acknowledge and agree that any such use of TI products which TI has not designated as military-grade is solely at the Buyer's risk, and that they are solely responsible for compliance with all legal and regulatory requirements in connection with such use.

TI products are neither designed nor intended for use in automotive applications or environments unless the specific TI products are designated by TI as compliant with ISO/TS 16949 requirements. Buyers acknowledge and agree that, if they use any non-designated products in automotive applications, TI will not be responsible for any failure to meet such requirements.

Following are URLs where you can obtain information on other Texas Instruments products and application solutions:

Products

Amplifiers	amplifier.ti.com
Data Converters	dataconverter.ti.com
DSP	dsp.ti.com
Clocks and Timers	www.ti.com/clocks
Interface	interface.ti.com
Logic	logic.ti.com
Power Mgmt	power.ti.com
Microcontrollers	microcontroller.ti.com
RFID	www.ti-rfid.com
RF/IF and ZigBee® Solutions	www.ti.com/lprf

Applications

Audio	www.ti.com/audio
Automotive	www.ti.com/automotive
Broadband	www.ti.com/broadband
Digital Control	www.ti.com/digitalcontrol
Medical	www.ti.com/medical
Military	www.ti.com/military
Optical Networking	www.ti.com/opticalnetwork
Security	www.ti.com/security
Telephony	www.ti.com/telephony
Video & Imaging	www.ti.com/video
Wireless	www.ti.com/wireless

Mailing Address: Texas Instruments, Post Office Box 655303, Dallas, Texas 75265
Copyright © 2008, Texas Instruments Incorporated

www.BDTIC.com/TI