

- Low Input Bias Current . . . 50 pA Typ
- Low Input Noise Current
0.01 pA/√Hz Typ
- Low Total Harmonic Distortion
- Low Supply Current . . . 8 mA Typ
- Gain Bandwidth . . . 3 MHz Typ
- High Slew Rate . . . 13 V/μs Typ
- Pin Compatible With the LM348

D OR N PACKAGE
(TOP VIEW)

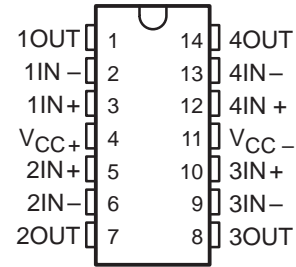

description

These devices are low-cost, high-speed, JFET-input operational amplifiers. They require low supply current yet maintain a large gain-bandwidth product and a fast slew rate. In addition, their matched high-voltage JFET inputs provide very low input bias and offset current.

The LF347 and LF347B can be used in applications such as high-speed integrators, digital-to-analog converters, sample-and-hold circuits, and many other circuits.

The LF347 and LF347B are characterized for operation from 0°C to 70°C.

symbol (each amplifier)

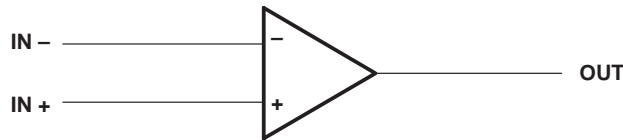

AVAILABLE OPTIONS

| T _A | V _{IO} max AT 25°C | PACKAGE | |
|----------------|--------------------------------|----------------------|--------------------|
| | | SMALL OUTLINE (D) | PLASTIC DIP (N) |
| 0°C to 70°C | 10 mV | LF347D | LF347N |
| | 5 mV | LF347BD | LF347BN |

The D packages are available taped and reeled. Add R suffix to the device type (e.g., LF347DR).

absolute maximum ratings over operating free-air temperature range (unless otherwise noted)

| | |
|--|------------------------------|
| Supply voltage, V _{CC+} | 18 V |
| Supply voltage, V _{CC-} | -18 V |
| Differential input voltage, V _{ID} | ±30 V |
| Input voltage, V _I (see Note 1) | ±15 V |
| Duration of output short circuit | unlimited |
| Continuous total power dissipation | See Dissipation Rating Table |
| Operating temperature range | 0°C to 70°C |
| Storage temperature range | -65°C to 150°C |
| Lead temperature 1,6 mm (1/16 inch) from case for 10 seconds | 260°C |

NOTE 1: Unless otherwise specified, the absolute maximum negative input voltage is equal to the negative power supply voltage.

LF347, LF347B
JFET-INPUT
QUAD OPERATIONAL AMPLIFIERS

SLOS013B – MARCH 1987 – REVISED AUGUST 1994

DISSIPATION RATING TABLE

| PACKAGE | T _A ≤ 25°C POWER RATING | DERATING FACTOR | DERATE ABOVE T _A | T _A = 70°C POWER RATING |
|---------|---------------------------------------|--------------------|--------------------------------|---------------------------------------|
| D | 608 mW | 7.6 mW/°C | 61°C | 608 mW |
| N | 680 mW | N/A | N/A | 680 mW |

recommended operating conditions

| | MIN | MAX | UNIT |
|-----------------------------------|------|-----|------|
| Supply voltage, V _{CC} + | 3.5 | 18 | V |
| Supply voltage, V _{CC} – | –3.5 | –18 | V |

electrical characteristics over operating free-air temperature range, V_{CC±} = ±15 V (unless otherwise specified)

| PARAMETER | TEST CONDITIONS | T _A † | LF347 | | | LF347B | | | UNIT |
|--|--|------------------|------------------|-----------|-----|------------------|-----------|-------|------|
| | | | MIN | TYP | MAX | MIN | TYP | MAX | |
| V _{IO} Input offset voltage | V _{IC} = 0, R _S = 10 kΩ | 25°C | 5 | 10 | | 3 | 5 | mV | |
| | | Full range | | | 13 | | 7 | | |
| α _{VIO} Average temperature coefficient of input offset voltage | V _{IC} = 0, R _S = 10 kΩ | | 18 | | | 18 | | μV/°C | |
| I _{IO} Input offset current ‡ | V _{IC} = 0 | 25°C | 25 | 100 | | 25 | 100 | pA | |
| | | 70°C | | 4 | | | 4 | nA | |
| I _{IB} Input bias current ‡ | V _{IC} = 0 | 25°C | 50 | 200 | | 50 | 200 | pA | |
| | | 70°C | | 8 | | | 8 | nA | |
| V _{ICR} Common-mode input voltage range | | | ±11 | –12 to 15 | | ±11 | –12 to 15 | V | |
| V _{OM} Maximum peak output voltage swing | R _L = 10 kΩ | | ±12 | ±13.5 | | ±12 | ±13.5 | V | |
| A _{VD} Large-signal differential voltage | V _O = ±10 V, R _L = 2 kΩ | 25°C | 25 | 100 | | 50 | 100 | V/mV | |
| | | Full range | 15 | | | 25 | | | |
| r _i Input resistance | T _A = 25°C | | 10 ¹² | | | 10 ¹² | | Ω | |
| CMRR Common-mode rejection ratio | R _S ≤ 2 kΩ | | 70 | 100 | | 80 | 100 | dB | |
| k _{SVR} Supply-voltage rejection ratio | See Note 2 | | 70 | 100 | | 80 | 100 | dB | |
| I _{CC} Supply current | | | 8 | 11 | | 8 | 11 | mA | |

† Full range is 0°C to 70°C.

‡ Input bias currents of a FET-input operational amplifier are normal junction reverse currents, which are temperature sensitive. Pulse techniques must be used that will maintain the junction temperatures as close to the ambient temperature as possible.

NOTE 2: Supply-voltage rejection ratio is measured for both supply magnitudes increasing or decreasing simultaneously.

operating characteristics, V_{CC±} = ±15 V

| PARAMETER | TEST CONDITIONS | MIN | TYP | MAX | UNIT |
|--|----------------------------------|-----|------|-----|--------|
| V _{O1} /V _{O2} Crosstalk attenuation | f = 1 kHz | | 120 | | dB |
| SR Slew rate | | 8 | 13 | | V/μs |
| B ₁ Unity-gain bandwidth | | | 3 | | MHz |
| V _n Equivalent input noise voltage | f = 1 kHz, R _S = 20 Ω | | 18 | | nV/√Hz |
| I _n Equivalent input noise current | f = 1 kHz | | 0.01 | | pA/√Hz |



PACKAGING INFORMATION

| Orderable Device | Status ⁽¹⁾ | Package Type | Package Drawing | Pins | Package Qty | Eco Plan ⁽²⁾ | Lead/Ball Finish | MSL Peak Temp ⁽³⁾ |
|------------------|-----------------------|--------------|-----------------|------|-------------|-------------------------|------------------|------------------------------|
| LF347BD | ACTIVE | SOIC | D | 14 | 50 | Green (RoHS & no Sb/Br) | CU NIPDAU | Level-1-260C-UNLIM |
| LF347BDE4 | ACTIVE | SOIC | D | 14 | 50 | Green (RoHS & no Sb/Br) | CU NIPDAU | Level-1-260C-UNLIM |
| LF347BDG4 | ACTIVE | SOIC | D | 14 | 50 | Green (RoHS & no Sb/Br) | CU NIPDAU | Level-1-260C-UNLIM |
| LF347BDR | ACTIVE | SOIC | D | 14 | 2500 | Green (RoHS & no Sb/Br) | CU NIPDAU | Level-1-260C-UNLIM |
| LF347BDRE4 | ACTIVE | SOIC | D | 14 | 2500 | Green (RoHS & no Sb/Br) | CU NIPDAU | Level-1-260C-UNLIM |
| LF347BDRG4 | ACTIVE | SOIC | D | 14 | 2500 | Green (RoHS & no Sb/Br) | CU NIPDAU | Level-1-260C-UNLIM |
| LF347BN | ACTIVE | PDIP | N | 14 | 25 | Pb-Free (RoHS) | CU NIPDAU | N / A for Pkg Type |
| LF347BNE4 | ACTIVE | PDIP | N | 14 | 25 | Pb-Free (RoHS) | CU NIPDAU | N / A for Pkg Type |
| LF347D | ACTIVE | SOIC | D | 14 | 50 | Green (RoHS & no Sb/Br) | CU NIPDAU | Level-1-260C-UNLIM |
| LF347DE4 | ACTIVE | SOIC | D | 14 | 50 | Green (RoHS & no Sb/Br) | CU NIPDAU | Level-1-260C-UNLIM |
| LF347DG4 | ACTIVE | SOIC | D | 14 | 50 | Green (RoHS & no Sb/Br) | CU NIPDAU | Level-1-260C-UNLIM |
| LF347DR | ACTIVE | SOIC | D | 14 | 2500 | Green (RoHS & no Sb/Br) | CU NIPDAU | Level-1-260C-UNLIM |
| LF347DRE4 | ACTIVE | SOIC | D | 14 | 2500 | Green (RoHS & no Sb/Br) | CU NIPDAU | Level-1-260C-UNLIM |
| LF347DRG4 | ACTIVE | SOIC | D | 14 | 2500 | Green (RoHS & no Sb/Br) | CU NIPDAU | Level-1-260C-UNLIM |
| LF347N | ACTIVE | PDIP | N | 14 | 25 | Pb-Free (RoHS) | CU NIPDAU | N / A for Pkg Type |
| LF347NE4 | ACTIVE | PDIP | N | 14 | 25 | Pb-Free (RoHS) | CU NIPDAU | N / A for Pkg Type |

⁽¹⁾ The marketing status values are defined as follows:

ACTIVE: Product device recommended for new designs.

LIFEBUY: TI has announced that the device will be discontinued, and a lifetime-buy period is in effect.

NRND: Not recommended for new designs. Device is in production to support existing customers, but TI does not recommend using this part in a new design.

PREVIEW: Device has been announced but is not in production. Samples may or may not be available.

OBSOLETE: TI has discontinued the production of the device.

⁽²⁾ Eco Plan - The planned eco-friendly classification: Pb-Free (RoHS), Pb-Free (RoHS Exempt), or Green (RoHS & no Sb/Br) - please check <http://www.ti.com/productcontent> for the latest availability information and additional product content details.

TBD: The Pb-Free/Green conversion plan has not been defined.

Pb-Free (RoHS): TI's terms "Lead-Free" or "Pb-Free" mean semiconductor products that are compatible with the current RoHS requirements for all 6 substances, including the requirement that lead not exceed 0.1% by weight in homogeneous materials. Where designed to be soldered at high temperatures, TI Pb-Free products are suitable for use in specified lead-free processes.

Pb-Free (RoHS Exempt): This component has a RoHS exemption for either 1) lead-based flip-chip solder bumps used between the die and package, or 2) lead-based die adhesive used between the die and leadframe. The component is otherwise considered Pb-Free (RoHS compatible) as defined above.

Green (RoHS & no Sb/Br): TI defines "Green" to mean Pb-Free (RoHS compatible), and free of Bromine (Br) and Antimony (Sb) based flame retardants (Br or Sb do not exceed 0.1% by weight in homogeneous material)

⁽³⁾ MSL, Peak Temp. -- The Moisture Sensitivity Level rating according to the JEDEC industry standard classifications, and peak solder temperature.

Important Information and Disclaimer:The information provided on this page represents TI's knowledge and belief as of the date that it is provided. TI bases its knowledge and belief on information provided by third parties, and makes no representation or warranty as to the accuracy of such information. Efforts are underway to better integrate information from third parties. TI has taken and continues to take reasonable steps to provide representative and accurate information but may not have conducted destructive testing or chemical analysis on incoming materials and chemicals. TI and TI suppliers consider certain information to be proprietary, and thus CAS numbers and other limited information may not be available for release.

In no event shall TI's liability arising out of such information exceed the total purchase price of the TI part(s) at issue in this document sold by TI to Customer on an annual basis.

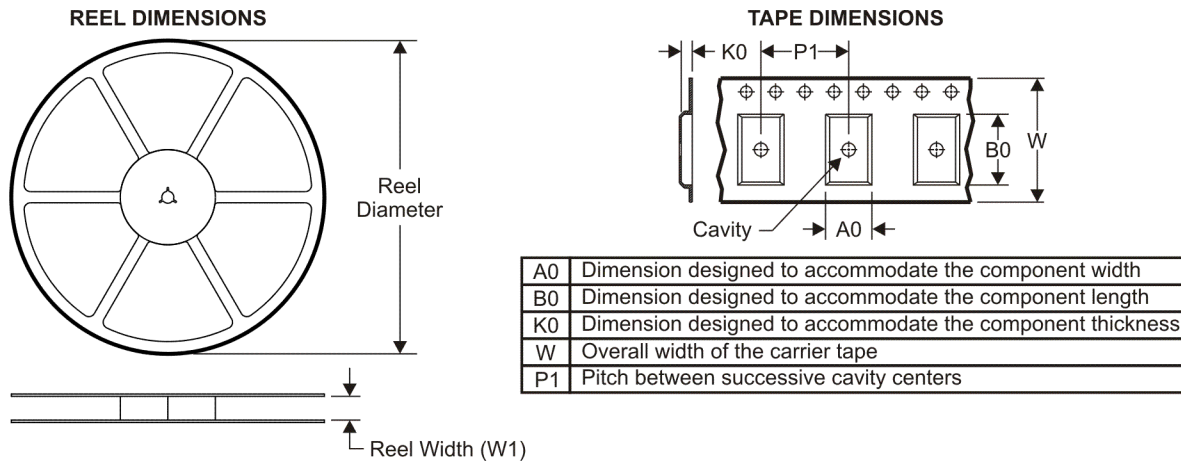
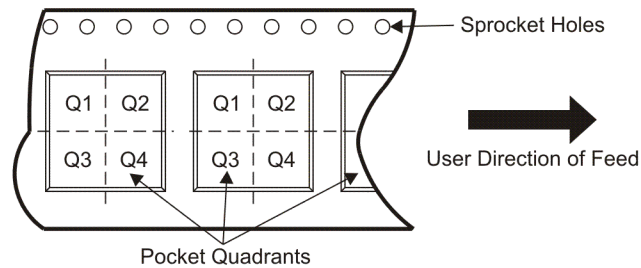
TAPE AND REEL INFORMATION

QUADRANT ASSIGNMENTS FOR PIN 1 ORIENTATION IN TAPE

*All dimensions are nominal

| Device | Package Type | Package Drawing | Pins | SPQ | Reel Diameter (mm) | Reel Width W1 (mm) | A0 (mm) | B0 (mm) | K0 (mm) | P1 (mm) | W (mm) | Pin1 Quadrant |
|----------|--------------|-----------------|------|------|--------------------|--------------------|---------|---------|---------|---------|--------|---------------|
| LF347BDR | SOIC | D | 14 | 2500 | 330.0 | 16.4 | 6.5 | 9.0 | 2.1 | 8.0 | 16.0 | Q1 |

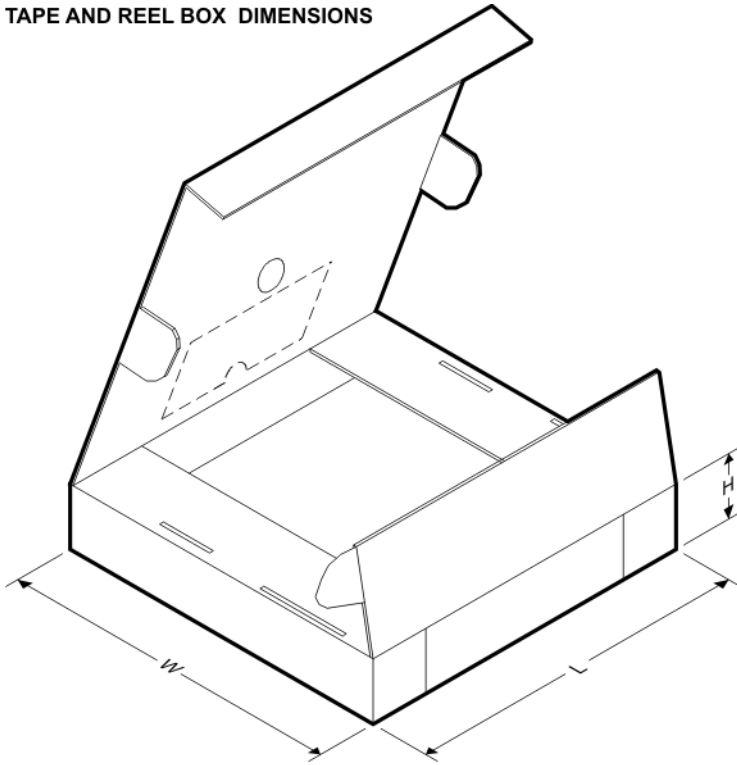
TAPE AND REEL BOX DIMENSIONS



*All dimensions are nominal

| Device | Package Type | Package Drawing | Pins | SPQ | Length (mm) | Width (mm) | Height (mm) |
|----------|--------------|-----------------|------|------|-------------|------------|-------------|
| LF347BDR | SOIC | D | 14 | 2500 | 333.2 | 345.9 | 28.6 |

N (R-PDIP-T**)

PLASTIC DUAL-IN-LINE PACKAGE

16 PINS SHOWN

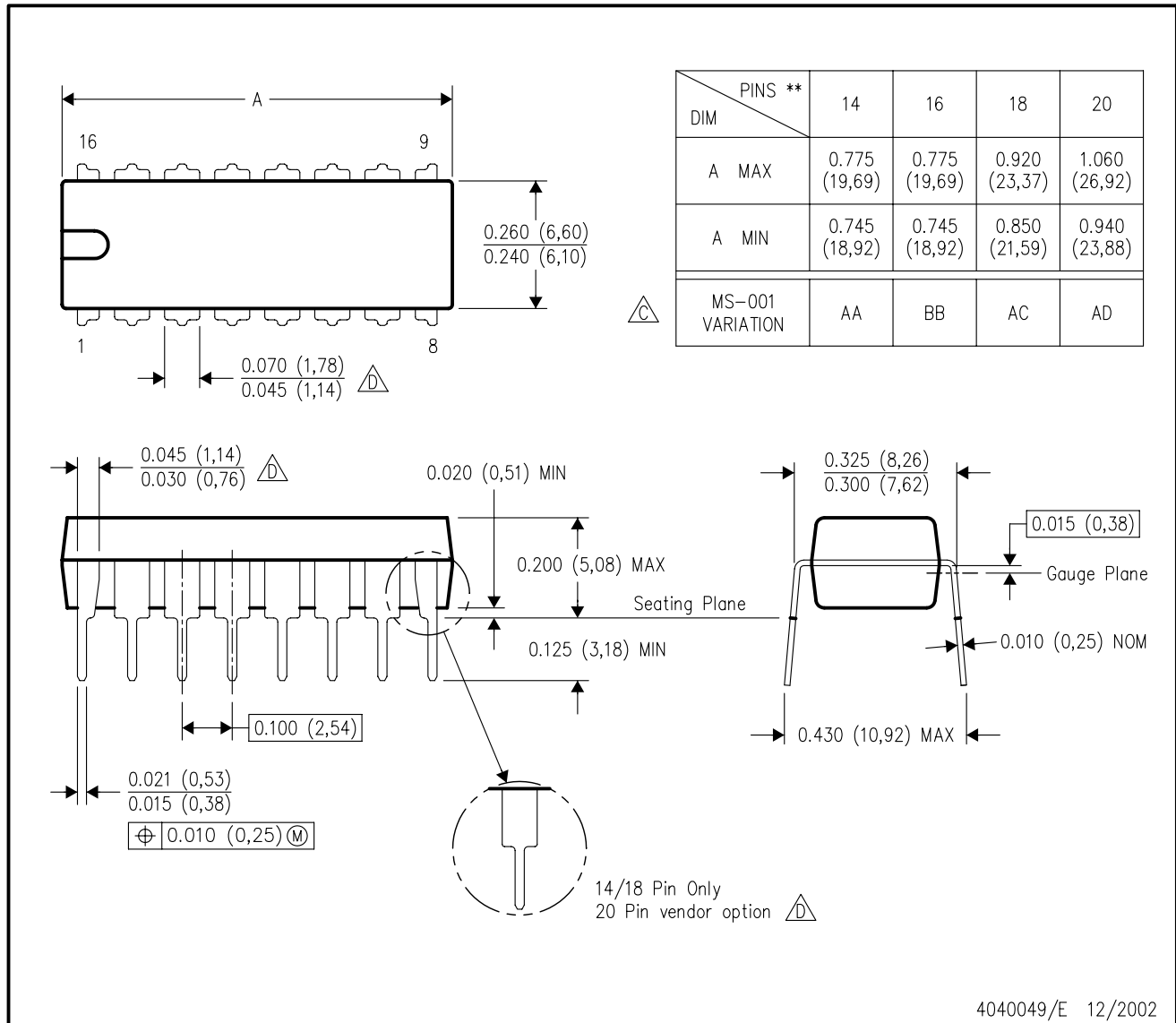

- NOTES:
- A. All linear dimensions are in inches (millimeters).
 - B. This drawing is subject to change without notice.
 - Falls within JEDEC MS-001, except 18 and 20 pin minimum body length (Dim A).
 - The 20 pin end lead shoulder width is a vendor option, either half or full width.

D (R-PDSO-G14)

PLASTIC SMALL OUTLINE

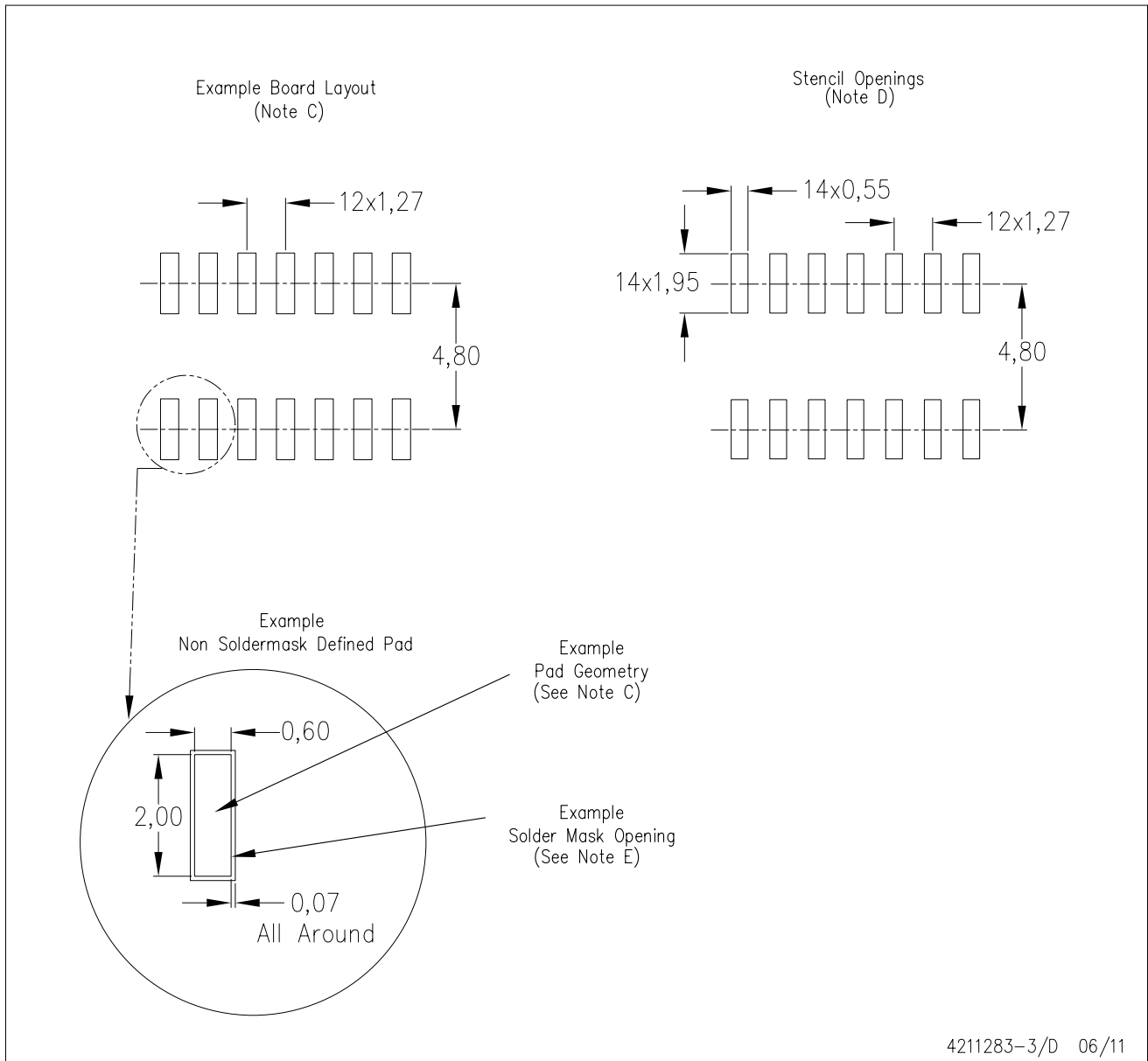

- NOTES:
- All linear dimensions are in millimeters.
 - This drawing is subject to change without notice.
 - Publication IPC-7351 is recommended for alternate designs.
 - Laser cutting apertures with trapezoidal walls and also rounding corners will offer better paste release. Customers should contact their board assembly site for stencil design recommendations. Refer to IPC-7525 for other stencil recommendations.
 - Customers should contact their board fabrication site for solder mask tolerances between and around signal pads.

IMPORTANT NOTICE

Texas Instruments Incorporated and its subsidiaries (TI) reserve the right to make corrections, modifications, enhancements, improvements, and other changes to its products and services at any time and to discontinue any product or service without notice. Customers should obtain the latest relevant information before placing orders and should verify that such information is current and complete. All products are sold subject to TI's terms and conditions of sale supplied at the time of order acknowledgment.

TI warrants performance of its hardware products to the specifications applicable at the time of sale in accordance with TI's standard warranty. Testing and other quality control techniques are used to the extent TI deems necessary to support this warranty. Except where mandated by government requirements, testing of all parameters of each product is not necessarily performed.

TI assumes no liability for applications assistance or customer product design. Customers are responsible for their products and applications using TI components. To minimize the risks associated with customer products and applications, customers should provide adequate design and operating safeguards.

TI does not warrant or represent that any license, either express or implied, is granted under any TI patent right, copyright, mask work right, or other TI intellectual property right relating to any combination, machine, or process in which TI products or services are used. Information published by TI regarding third-party products or services does not constitute a license from TI to use such products or services or a warranty or endorsement thereof. Use of such information may require a license from a third party under the patents or other intellectual property of the third party, or a license from TI under the patents or other intellectual property of TI.

Reproduction of TI information in TI data books or data sheets is permissible only if reproduction is without alteration and is accompanied by all associated warranties, conditions, limitations, and notices. Reproduction of this information with alteration is an unfair and deceptive business practice. TI is not responsible or liable for such altered documentation. Information of third parties may be subject to additional restrictions.

Resale of TI products or services with statements different from or beyond the parameters stated by TI for that product or service voids all express and any implied warranties for the associated TI product or service and is an unfair and deceptive business practice. TI is not responsible or liable for any such statements.

TI products are not authorized for use in safety-critical applications (such as life support) where a failure of the TI product would reasonably be expected to cause severe personal injury or death, unless officers of the parties have executed an agreement specifically governing such use. Buyers represent that they have all necessary expertise in the safety and regulatory ramifications of their applications, and acknowledge and agree that they are solely responsible for all legal, regulatory and safety-related requirements concerning their products and any use of TI products in such safety-critical applications, notwithstanding any applications-related information or support that may be provided by TI. Further, Buyers must fully indemnify TI and its representatives against any damages arising out of the use of TI products in such safety-critical applications.

TI products are neither designed nor intended for use in military/aerospace applications or environments unless the TI products are specifically designated by TI as military-grade or "enhanced plastic." Only products designated by TI as military-grade meet military specifications. Buyers acknowledge and agree that any such use of TI products which TI has not designated as military-grade is solely at the Buyer's risk, and that they are solely responsible for compliance with all legal and regulatory requirements in connection with such use.

TI products are neither designed nor intended for use in automotive applications or environments unless the specific TI products are designated by TI as compliant with ISO/TS 16949 requirements. Buyers acknowledge and agree that, if they use any non-designated products in automotive applications, TI will not be responsible for any failure to meet such requirements.

Following are URLs where you can obtain information on other Texas Instruments products and application solutions:

Products

| | |
|-----------------------------|--|
| Audio | www.ti.com/audio |
| Amplifiers | amplifier.ti.com |
| Data Converters | dataconverter.ti.com |
| DLP® Products | www.dlp.com |
| DSP | dsp.ti.com |
| Clocks and Timers | www.ti.com/clocks |
| Interface | interface.ti.com |
| Logic | logic.ti.com |
| Power Mgmt | power.ti.com |
| Microcontrollers | microcontroller.ti.com |
| RFID | www.ti-rfid.com |
| RF/IF and ZigBee® Solutions | www.ti.com/lprf |

Applications

| | |
|-------------------------------|--|
| Communications and Telecom | www.ti.com/communications |
| Computers and Peripherals | www.ti.com/computers |
| Consumer Electronics | www.ti.com/consumer-apps |
| Energy and Lighting | www.ti.com/energy |
| Industrial | www.ti.com/industrial |
| Medical | www.ti.com/medical |
| Security | www.ti.com/security |
| Space, Avionics and Defense | www.ti.com/space-avionics-defense |
| Transportation and Automotive | www.ti.com/automotive |
| Video and Imaging | www.ti.com/video |
| Wireless | www.ti.com/wireless-apps |

TI E2E Community Home Page

e2e.ti.com

Mailing Address: Texas Instruments, Post Office Box 655303, Dallas, Texas 75265
Copyright © 2011, Texas Instruments Incorporated