



Features

- Wide Input Voltage Range: 38V to 75V
- 1,500 VDC Isolation
- 6 Pin DIP Package
- Low-Profile (8mm)
- Pin-compatible with PT4200 Series
- No External Components Required ²
- Safety Approvals —Pending

Description

The PT4210 series of low-power isolated DC-DC converters are pin-

compatible with Power Trends' popular PT4200 series. The PT4210 series has improved load regulation over the PT4200, and is a compatible alternative for both new and existing designs. Applications include Telecom and Datacom systems where both board space and height are a premium.

The PT4210 series is offered in both through-hole or SMD-DIP package types with single non-adjustable output voltages of 3.3V, 5V, and 12V.

Ordering Information

- PT4212□ = 3.3V/1.5A
 PT4213□ = 5V/1.2A
 PT4214□ = 12V/0.6A

Package Suffix (PT1234X)

Case/Pin Configuration	
Through-Hole	A
Surface Mount	C

(For dimensions and PC board layout, see Package Style 910)

Pin-Out Information

Pin	Function
1	+V _{out}
2	-V _{out}
8	N/C
11	Remote On/Off *
17	-V _{in}
18	+V _{in}

Package Top View

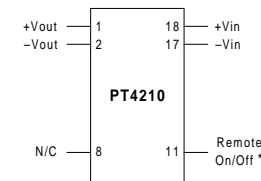

Specifications

Characteristics (T _a = 25°C unless noted)	Symbols	Conditions		PT4210 SERIES			Units
				Min	Typ	Max	
Output Current	I _o	Over V _{in} range	PT4212 (3.3V) PT4213 (5.0V) PT4214 (12V)	0 0 0	— — —	1.5 1.2 0.6	A
Output Voltage Tolerance	ΔV _o	Over V _{in} range, 10% I _{o,max} ≤ I _o ≤ I _{o,max} , -40°C < T _a < 85°C	PT4212 PT4213 PT4214	3.17 4.85 11.5	— — —	3.5 5.25 12.5	V
Idling Voltage	V _o	I _o = 0A	PT4212 PT4213 PT4214	— — —	3.7 5.4 12.7	3.9 5.9 17	V
Line Regulation	Reg _{line}	Over V _{in} range @ max I _o	PT4212/4213 PT4214	— —	±20 ±45	— —	mV
Load Regulation	Reg _{load}	V _{in} = 53V 10% I _{o,max} ≤ I _o ≤ I _{o,max}	PT4212/13 PT4214	— —	±100 ±150	— —	mV
Current Limit	I _{lim}	Over V _{in} range	PT4212 PT4213 PT4214	— — —	3.0 3.0 1.5	— — —	A
Short Circuit Current	I _{sc}	Over V _{in} range	PT4212 PT4213 PT4214	— — —	2.4 1.5 1.0	— — —	A
Inrush Current	I _{ir} t _{ir}	V _{in} = 53V @ max I _o On start-up		— —	0.5 1.0	— —	A mSec
Input Voltage Range	V _{in}	Over I _o range		38	—	75	V
V _o Ripple/Noise	V _n	V _{in} = 53V, I _o = I _{o,max}		—	30	70	mV _{pp}
Transient Response	t _{tr}	V _{in} = 53V, 10%..100% I _{o,max} , 50% load step V _o over/undershoot:	PT4212/4213 PT4214	— —	200 +150/-250 +250/-500	— — —	μSec mV
Efficiency	η	V _{in} = 53V, I _o = 1.5A, V _{in} = 53V, I _o = 1.2A, V _{in} = 53V, I _o = 0.6A,	PT4212 PT4213 PT4214	— — —	80 82 84	— — —	%
Switching Frequency	f _o	Over V _{in} and I _o ranges		400	—	500	kHz
Operating Temperature	T _a	Over V _{in} range		-40	—	+85 (1)	°C
Storage Temperature	T _s	—		-40	—	+125	°C
Mechanical Shock	—	Per Mil-STD-202F, Method 213B, 6mS half-sine, mounted to a PCB		—	TBD	—	G's
Mechanical Vibration	—	Per Mil-STD-202F, Method 204D, 10-500Hz, mounted to a PCB		—	TBD	—	G's
Weight	—	—		—	10	—	grams
Isolation	—	—		1500	—	—	VDC
Flammability	—	Materials meet UL 94V-0		—	—	—	—

Notes: (1) See SOA curves or consult the factory for the appropriate derating.

(2) The maximum output capacitance must not exceed 150μF for the PT4212, 120μF for the PT4213, and 47μF for the PT4214.

5-7 Watt Low-Profile
Isolated DC-DC Converter

PT4212 Performance (See Note A)

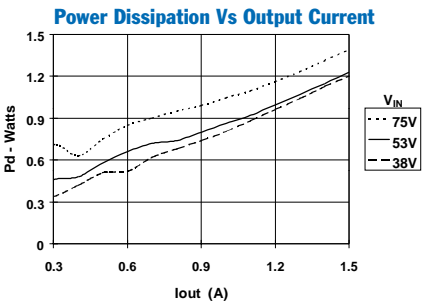
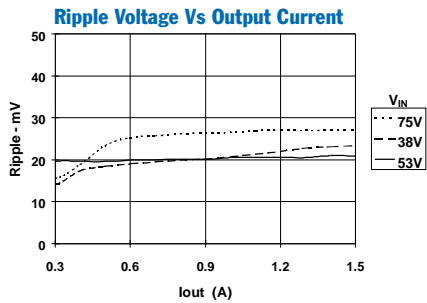
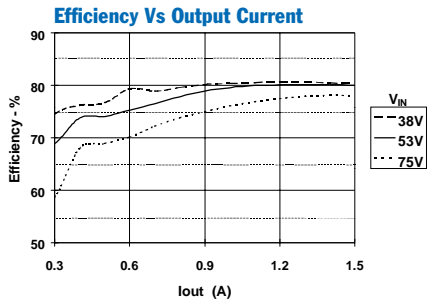

Safe Operating Area, V_{in} = 36–60V

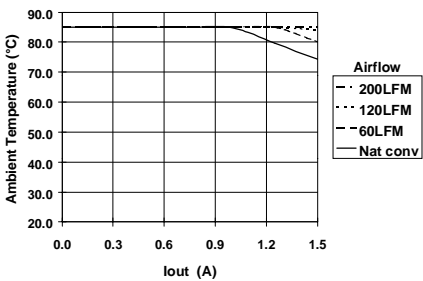

PT4213 Performance (See Note A)

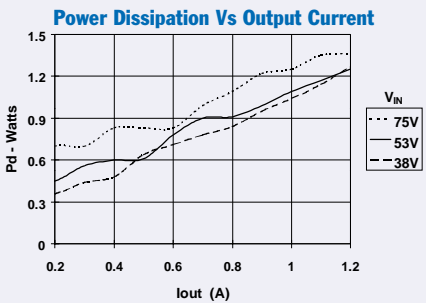
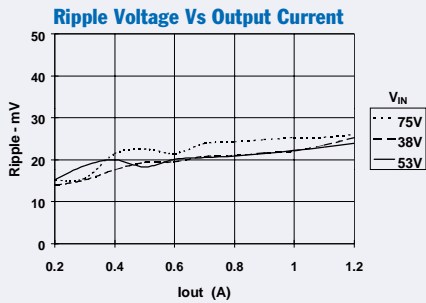
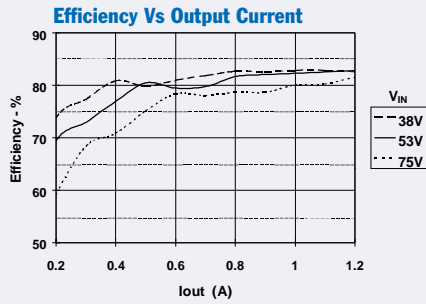

Safe Operating Area, V_{in} = 36–60V

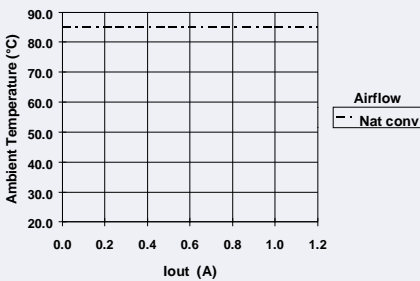

PT4214 Performance (See Note A)

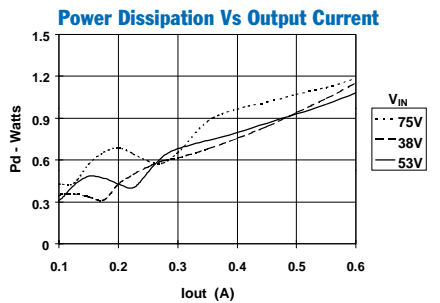
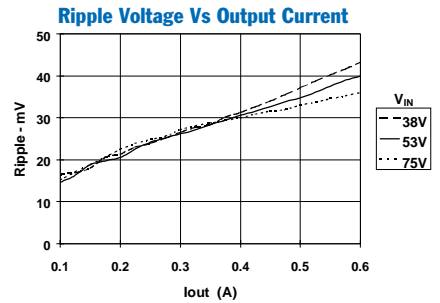
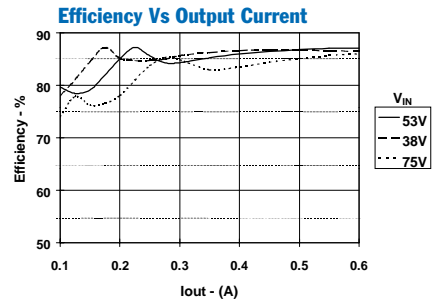

Safe Operating Area, V_{in} = 36–60V

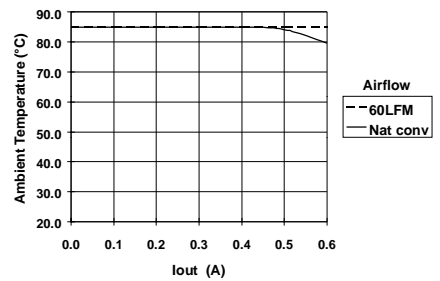

Note A: All Characteristic data in the above graphs has been developed from actual products tested at 25°C. This data is considered typical data for the converter.
Note B: SOA curves represent operating conditions at which internal components are at or below manufacturer's maximum rated operating temperatures.

Using the Remote On/Off Function on the PT4210 Isolated 7W DC/DC Converters

Applications requiring output voltage On/Off control, the PT4210 DC/DC converter series incorporates a “Remote On/Off” control (pin 11). This feature can be used when there is a requirement for the module to be switched off without removing the applied input source voltage.

The converter functions normally with Pin 11 open-circuit, providing a regulated output voltage when a valid source voltage is applied to +V_{in} (pin 18), with respect to -V_{in} (pin 17). When a low-level¹ ground signal is applied to pin 11, the converter output will be turned off.

Figure 1 shows an application schematic, which details the typical use of the Remote On/Off function. Note the discrete transistor (Q1). The control pin has its own internal pull-up, and must be controlled with an open-collector or open-drain device (See notes 2 & 3). Table 1 gives the input requirements.

When placed in the “Off” state, the standby current drawn from the input source is typically reduced to less than 1mA.

Table 1; Remote On/Off Control Requirements¹

Parameter	Min	Typ	Max
Disable	-0.1V	—	1.0V
Enable	5.0V ³	—	Open-Circuit ²
V _{O/c} [Open-Circuit]	—	—	10V
I _{in} [pin 11 at -V _{in}]	—	-100µA	—

Notes:

1. The Remote On/Off control uses -V_{in} (pin 17) as its ground reference. All voltages specified are with respect to -V_{in}.
2. Use an open-collector device (preferably a discrete transistor) for the Remote On/Off input. Do not connect a pull-up resistor directly to pin 11.
3. The Remote On/Off pin may be controlled with devices that have a totem-pole output providing that a blocking diode is used (See Figure 1). The blocking diode is required to prevent current from being injected into On/Off control pin. *Note: For TTL devices a pull-up may be required on the cathode side of the blocking diode. This is to guarantee a minimum enable voltage at pin 11 (See Figure 1).*
4. The PT4210 converters incorporate an “Under-Voltage Lockout” (UVLO). The UVLO will keep the module off when the input voltage to the converter is low, regardless of the state of the Remote On/Off control. Table 2 gives the UVLO input voltage thresholds.

Table 2; UVLO Thresholds⁴

Series	V _{in} Range	UVLO Threshold
PT4210	38 – 75V	36V ±2V

Figure 1

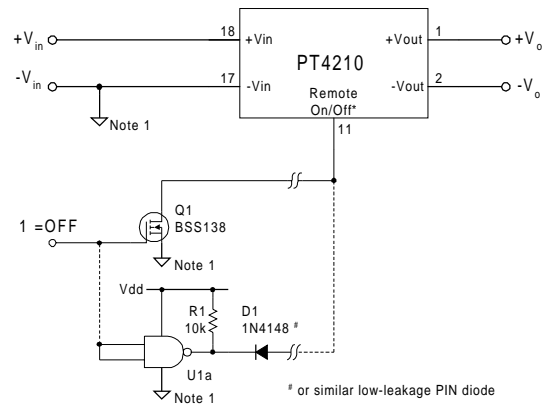

Turn-On Time: In the circuit of Figure 1, turning Q₁ on applies a low-voltage to pin 11 and disables the converter output. Correspondingly, turning Q₁ off allows pin 11 to be pulled high by an internal pull-up resistor. The converter produces a regulated output voltage within 50ms. Although the rise-time of the output is short (<1ms), the delay time will vary depending upon the input voltage and the module’s internal timing. Figure 2 shows an example of the output response for a PT4213 (5.0V), following the turn-off of Q₁ at time t = 0. The waveform was measured with a 48Vdc input voltage, and 1.2A dc resistive load.

Figure 2

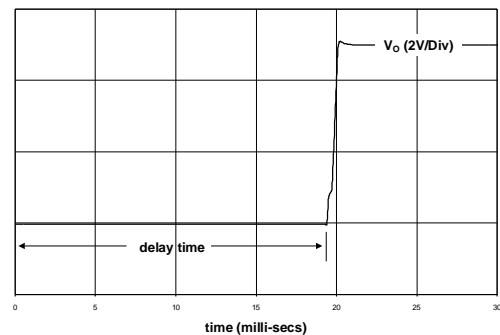

PACKAGE INFORMATION AND DIMENSIONS

Horizontal Through-Hole Mount (Suffix A)

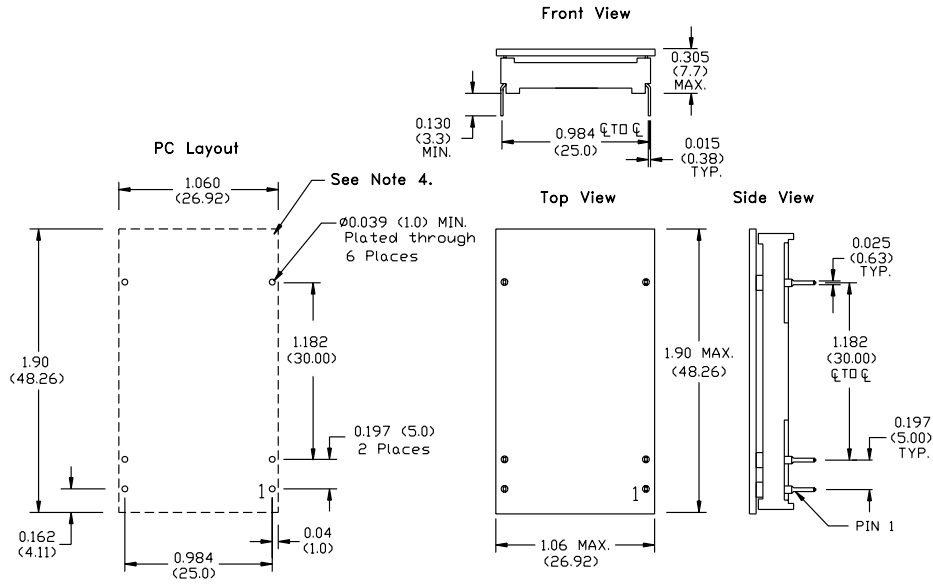

Surface Mount (Suffix C)

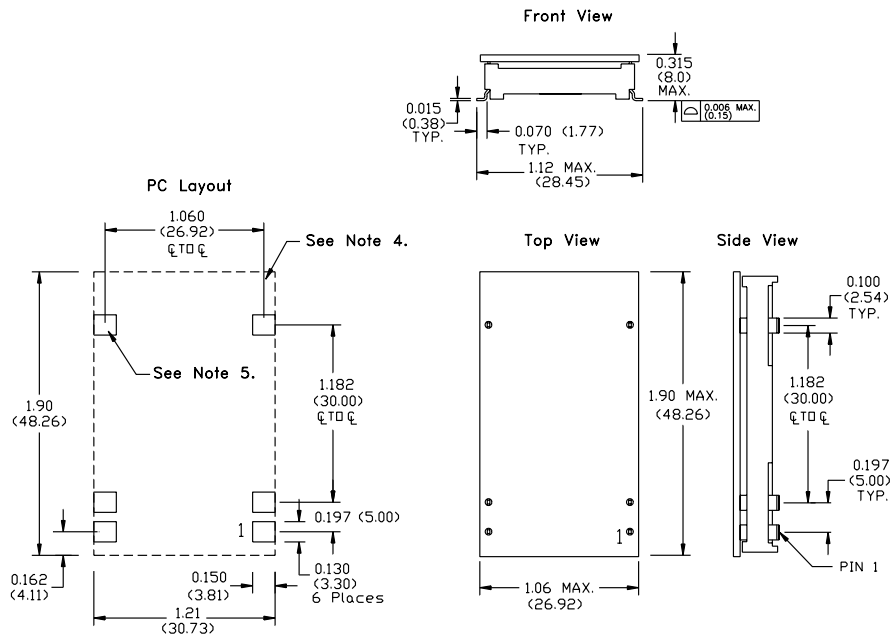

- Notes: (Rev.A)
- 1: All dimensions are in inches (mm).
 - 2: 2 place decimals are ± 0.30 (± 0.8 mm).
 - 3: 3 place decimals are ± 0.10 (± 0.3 mm).
 - 4: Recommended mechanical keep out area.
 - 5: Power pin connections should utilize two or more vias per input, ground and output pin.

PACKAGING INFORMATION

Orderable Device	Status ⁽¹⁾	Package Type	Package Drawing	Pins	Package Qty	Eco Plan ⁽²⁾	Lead/Ball Finish	MSL Peak Temp ⁽³⁾
PT4212A	ACTIVE	DIP MOD ULE	EGH	6	18	TBD	Call TI	Level-1-215C-UNLIM
PT4212C	ACTIVE	DIP MOD ULE	EGJ	6	18	TBD	Call TI	Level-1-215C-UNLIM
PT4213A	ACTIVE	DIP MOD ULE	EGH	6	18	TBD	Call TI	Level-1-215C-UNLIM
PT4213C	ACTIVE	DIP MOD ULE	EGJ	6	18	TBD	Call TI	Level-1-215C-UNLIM
PT4214A	ACTIVE	DIP MOD ULE	EGH	6	18	TBD	Call TI	Level-1-215C-UNLIM
PT4214C	ACTIVE	DIP MOD ULE	EGJ	6	18	TBD	Call TI	Level-1-215C-UNLIM

⁽¹⁾ The marketing status values are defined as follows:

ACTIVE: Product device recommended for new designs.

LIFEBUY: TI has announced that the device will be discontinued, and a lifetime-buy period is in effect.

NRND: Not recommended for new designs. Device is in production to support existing customers, but TI does not recommend using this part in a new design.

PREVIEW: Device has been announced but is not in production. Samples may or may not be available.

OBSOLETE: TI has discontinued the production of the device.

⁽²⁾ Eco Plan - The planned eco-friendly classification: Pb-Free (RoHS), Pb-Free (RoHS Exempt), or Green (RoHS & no Sb/Br) - please check <http://www.ti.com/productcontent> for the latest availability information and additional product content details.

TBD: The Pb-Free/Green conversion plan has not been defined.

Pb-Free (RoHS): TI's terms "Lead-Free" or "Pb-Free" mean semiconductor products that are compatible with the current RoHS requirements for all 6 substances, including the requirement that lead not exceed 0.1% by weight in homogeneous materials. Where designed to be soldered at high temperatures, TI Pb-Free products are suitable for use in specified lead-free processes.

Pb-Free (RoHS Exempt): This component has a RoHS exemption for either 1) lead-based flip-chip solder bumps used between the die and package, or 2) lead-based die adhesive used between the die and leadframe. The component is otherwise considered Pb-Free (RoHS compatible) as defined above.

Green (RoHS & no Sb/Br): TI defines "Green" to mean Pb-Free (RoHS compatible), and free of Bromine (Br) and Antimony (Sb) based flame retardants (Br or Sb do not exceed 0.1% by weight in homogeneous material)

⁽³⁾ MSL, Peak Temp. -- The Moisture Sensitivity Level rating according to the JEDEC industry standard classifications, and peak solder temperature.

Important Information and Disclaimer:The information provided on this page represents TI's knowledge and belief as of the date that it is provided. TI bases its knowledge and belief on information provided by third parties, and makes no representation or warranty as to the accuracy of such information. Efforts are underway to better integrate information from third parties. TI has taken and continues to take reasonable steps to provide representative and accurate information but may not have conducted destructive testing or chemical analysis on incoming materials and chemicals. TI and TI suppliers consider certain information to be proprietary, and thus CAS numbers and other limited information may not be available for release.

In no event shall TI's liability arising out of such information exceed the total purchase price of the TI part(s) at issue in this document sold by TI to Customer on an annual basis.

IMPORTANT NOTICE

Texas Instruments Incorporated and its subsidiaries (TI) reserve the right to make corrections, modifications, enhancements, improvements, and other changes to its products and services at any time and to discontinue any product or service without notice. Customers should obtain the latest relevant information before placing orders and should verify that such information is current and complete. All products are sold subject to TI's terms and conditions of sale supplied at the time of order acknowledgment.

TI warrants performance of its hardware products to the specifications applicable at the time of sale in accordance with TI's standard warranty. Testing and other quality control techniques are used to the extent TI deems necessary to support this warranty. Except where mandated by government requirements, testing of all parameters of each product is not necessarily performed.

TI assumes no liability for applications assistance or customer product design. Customers are responsible for their products and applications using TI components. To minimize the risks associated with customer products and applications, customers should provide adequate design and operating safeguards.

TI does not warrant or represent that any license, either express or implied, is granted under any TI patent right, copyright, mask work right, or other TI intellectual property right relating to any combination, machine, or process in which TI products or services are used. Information published by TI regarding third-party products or services does not constitute a license from TI to use such products or services or a warranty or endorsement thereof. Use of such information may require a license from a third party under the patents or other intellectual property of the third party, or a license from TI under the patents or other intellectual property of TI.

Reproduction of TI information in TI data books or data sheets is permissible only if reproduction is without alteration and is accompanied by all associated warranties, conditions, limitations, and notices. Reproduction of this information with alteration is an unfair and deceptive business practice. TI is not responsible or liable for such altered documentation. Information of third parties may be subject to additional restrictions.

Resale of TI products or services with statements different from or beyond the parameters stated by TI for that product or service voids all express and any implied warranties for the associated TI product or service and is an unfair and deceptive business practice. TI is not responsible or liable for any such statements.

TI products are not authorized for use in safety-critical applications (such as life support) where a failure of the TI product would reasonably be expected to cause severe personal injury or death, unless officers of the parties have executed an agreement specifically governing such use. Buyers represent that they have all necessary expertise in the safety and regulatory ramifications of their applications, and acknowledge and agree that they are solely responsible for all legal, regulatory and safety-related requirements concerning their products and any use of TI products in such safety-critical applications, notwithstanding any applications-related information or support that may be provided by TI. Further, Buyers must fully indemnify TI and its representatives against any damages arising out of the use of TI products in such safety-critical applications.

TI products are neither designed nor intended for use in military/aerospace applications or environments unless the TI products are specifically designated by TI as military-grade or "enhanced plastic." Only products designated by TI as military-grade meet military specifications. Buyers acknowledge and agree that any such use of TI products which TI has not designated as military-grade is solely at the Buyer's risk, and that they are solely responsible for compliance with all legal and regulatory requirements in connection with such use.

TI products are neither designed nor intended for use in automotive applications or environments unless the specific TI products are designated by TI as compliant with ISO/TS 16949 requirements. Buyers acknowledge and agree that, if they use any non-designated products in automotive applications, TI will not be responsible for any failure to meet such requirements.

Following are URLs where you can obtain information on other Texas Instruments products and application solutions:

Products

Amplifiers	amplifier.ti.com
Data Converters	dataconverter.ti.com
DSP	dsp.ti.com
Interface	interface.ti.com
Logic	logic.ti.com
Power Mgmt	power.ti.com
Microcontrollers	microcontroller.ti.com
RFID	www.ti-rfid.com
Low Power Wireless	www.ti.com/lpw

Applications

Audio	www.ti.com/audio
Automotive	www.ti.com/automotive
Broadband	www.ti.com/broadband
Digital Control	www.ti.com/digitalcontrol
Military	www.ti.com/military
Optical Networking	www.ti.com/opticalnetwork
Security	www.ti.com/security
Telephony	www.ti.com/telephony
Video & Imaging	www.ti.com/video
Wireless	www.ti.com/wireless

Mailing Address: Texas Instruments, Post Office Box 655303, Dallas, Texas 75265
Copyright © 2007, Texas Instruments Incorporated

www.BDTIC.com/TI