

## 1.5-A, WIDE-INPUT ADJUSTABLE SWITCHING REGULATOR

### FEATURES

- 1.5-A Output Current
- Wide-Input Voltage  
(7 V to 36 V) / (15 V to 36 V)
- Wide-Output Voltage Adjust  
(2.5 V to 12.6 V) / (11.85 V to 22 V)
- High Efficiency (Up to 95%)
- On/Off Inhibit
- Undervoltage Lockout
- Output Current Limit
- Overtemperature Shutdown
- Operating Temperature:  $-40^{\circ}\text{C}$  to  $85^{\circ}\text{C}$
- Surface Mount Package Available

### APPLICATIONS

- General-Purpose, Industrial Controls, HVAC Systems, Test and Measurement, Medical Instrumentation, AC/DC Adaptors, Vehicles, Marine, and Avionics

### STANDARD APPLICATION

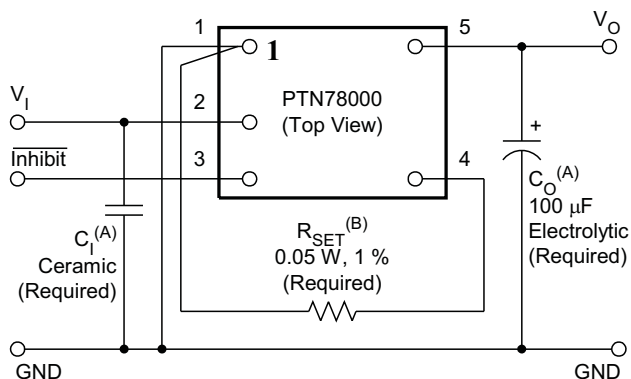

(A) See the *Application Information* section for capacitor recommendations. The minimum input capacitance is  $2.2\ \mu\text{F}$  for PTN78000W, and  $9.4\ \mu\text{F}$  ( $2 \times 4.7\ \mu\text{F}$ ) for PTN78000H.

(B)  $R_{\text{SET}}$  is required to adjust the output voltage higher than 2.5 V for PTN78000W, and high than 11.824 V for PTN78000H. See the *Application Information* section for specific values.

### DESCRIPTION

The PTN78000 is a series of high-efficiency, step-down Integrated Switching Regulators (ISR), that represent the third generation in the evolution of the popular 78ST100 series of products. In new designs it should be considered in place of the 78ST100, PT78ST100, PT5100, and PT6100 series of single in-line pin (SIP) products. The PTN78000 is smaller and lighter than its predecessors, and has either similar or improved electrical performance characteristics. The case-less, double-sided package, also exhibits improved thermal characteristics, and is compatible with TI's roadmap for RoHS and lead-free compliance.

Operating from a wide-input voltage range, the PTN78000 provides high-efficiency, step-down voltage conversion for loads of up to 1.5 A. The output voltage is set using a single external resistor. The PTN78000W may be set to any value within the range, 2.5 V to 12.6 V, and the PTN78000H from 11.85 V to 22 V. The output voltage of the PTN78000W can be as little as 2 V lower than the input, allowing operation down to 7 V, with an output voltage of 5 V. The output voltage of the PTN78000H can be as little as 3 V lower than the input, allowing operation down to 15 V, with an output voltage of 12 V.

The PTN78000 has undervoltage lockout and an integral on/off inhibit. The modules are suited to a wide variety of general-purpose applications that operate off 12-V, 24-V, or 28-V<sub>DC</sub> power.



Please be aware that an important notice concerning availability, standard warranty, and use in critical applications of Texas Instruments semiconductor products and disclaimers thereto appears at the end of this data sheet.



These devices have limited built-in ESD protection. The leads should be shorted together or the device placed in conductive foam during storage or handling to prevent electrostatic damage to the MOS gates.

### ORDERING INFORMATION

For the most current package and ordering information, see the Package Option Addendum at the end of this datasheet, or see the TI website at [www.ti.com](http://www.ti.com).

### ABSOLUTE MAXIMUM RATINGS <sup>(1)</sup>

over operating free-air temperature range unless otherwise noted, all voltages with respect to GND (pin 1),

			PTN78000W	UNIT
$T_A$	Operating free-air temperature	Over $V_I$ range	–40 to 85	°C
	Wave solder temperature	Surface temperature of module body or pins ( <b>5 seconds</b> )	260	
	Solder reflow temperature	Surface temperature of module body or pins	Horizontal TH (suffix AH)	
			Horizontal SMD (suffix AS)	
			Horizontal SMD (suffix AZ)	260
$T_{stg}$	Storage temperature		–55 to 125	
$V_I$	Input surge voltage, 10 ms maximum		38	V
$V_{INH}$	Inhibit (pin 3) input voltage		–0.3 to 5	

(1) Stresses beyond those listed under absolute maximum ratings may cause permanent damage to the device. These are stress ratings only, and functional operation of the device at these or any other conditions beyond those indicated under recommended operating conditions is not implied. Exposure to absolute-maximum-rated conditions for extended periods may affect device reliability.

### RECOMMENDED OPERATING CONDITIONS

		MIN	MAX	UNIT	
$V_I$	Input voltage	PTN78000W	7	36	V
		PTN78000H	15	36	
$T_A$	Operating free-air temperature		–40	85	°C

### PACKAGE SPECIFICATIONS

PTN78000x (Suffix AH, AS, and AZ)			
Weight			2 grams
Flammability	Meets UL 94 V-O		
Mechanical shock	Per Mil-STD-883D, Method 2002.3, 1 ms, 1/2 sine, mounted		500 G <sup>(1)</sup>
Mechanical vibration	Mil-STD-883D, Method 2007.2, 20-2000 Hz	Horizontal T/H (suffix AH)	20 G <sup>(1)</sup>
		Horizontal SMD (suffix AS and AZ)	15 G <sup>(1)</sup>

(1) Qualification limit.

## ELECTRICAL CHARACTERISTICS

 operating at 25°C free-air temperature,  $V_I = 20\text{ V}$ ,  $V_O = 5\text{ V}$ ,  $I_O = I_O(\text{max})$ ,  $C_I = 2.2\ \mu\text{F}$ ,  $C_O = 100\ \mu\text{F}$  (unless otherwise noted)

PARAMETER	TEST CONDITIONS	PTN78000W			
		MIN	TYP	MAX	UNIT
$I_O$ Output current	$T_A = 85^\circ\text{C}$ , natural convection airflow	0		1.5	A
$V_I$ Input voltage range	Over $I_O$ range	7 <sup>(1)</sup>		36 <sup>(2)</sup>	V
$V_O$	Set-point voltage tolerance	$T_A = 25^\circ\text{C}$		$\pm 2\%$ <sup>(3)</sup>	
	Temperature variation	–40°C to +85°C		$\pm 0.5\%$	
	Line regulation	Over $V_I$ range		$\pm 10$	mV
	Load regulation	Over $I_O$ range		$\pm 10$	mV
	Total output voltage variation	Includes set point, line, load –40°C < $T_A$ < 85°C			$\pm 3\%$ <sup>(3)</sup>
$V_O$ Adj Output voltage adjust range	$V_I < 12\text{ V}$	2.5		$V_I - 2$	V
	$12\text{ V} \leq V_I \leq 15.1\text{ V}$	2.5		$V_I - 2.5$	
	$15.1\text{ V} < V_I \leq 25\text{ V}$	2.5		12.6	
	$V_I > 25\text{ V}$	$0.1 \times V_I$		12.6	
$\eta$ Efficiency	$V_I = 24\text{ V}$ , $R_{\text{SET}} = 732\ \Omega$ , $V_O = 12\text{ V}$			91%	
	$V_I = 15\text{ V}$ , $R_{\text{SET}} = 21\ \text{k}\Omega$ , $V_O = 5\text{ V}$			86%	
	$V_I = 15\text{ V}$ , $R_{\text{SET}} = 78.7\ \text{k}\Omega$ , $V_O = 3.3\text{ V}$			82%	
Output voltage ripple	20 MHz bandwidth			1% $V_O$	$V_{(\text{PP})}$
$I_{O(\text{LIM})}$ Current limit threshold	$\Delta V_O = -50\text{ mV}$			3.2	A
Transient response	1 A/ $\mu\text{s}$ load step from 50% to 100% $I_{O(\text{max})}$				
	Recovery time			100	$\mu\text{s}$
	$V_O$ over/undershoot			2.5	% $V_O$
UVLO Undervoltage lockout	$V_I$ increasing			5.5	V
	$V_I$ decreasing			5.2	
Inhibit control (pin 3)	Input high voltage ( $V_{\text{IH}}$ )	1		Open <sup>(4)</sup>	V
	Input low voltage ( $V_{\text{IL}}$ )	–0.1		0.3	
	Input low current ( $I_{\text{IL}}$ )			0.25	
$I_I(\text{STBY})$ Input standby current	Pin 3 connected to GND			17	mA
$F_S$ Switching frequency	Over $V_I$ and $I_O$ ranges	440	550	660	kHz
$C_I$ External input capacitance	Ceramic			2.2 <sup>(5)</sup>	$\mu\text{F}$
	Nonceramic			100 <sup>(6)</sup>	
	Ceramic			200	
$C_O$ External output capacitance	Equiv. series resistance (nonceramic)			10 <sup>(7)</sup>	m $\Omega$
MTBF Calculated reliability	Per Telcordia SR-332, 50% stress, $T_A = 40^\circ\text{C}$ , ground benign			8.9	$10^6\text{ Hr}$

- (1) For output voltages less than 10 V, the minimum input voltage is 7 V or  $(V_O + 2)\text{ V}$ , whichever is greater. For output voltages of 10 V and higher, the minimum input voltage is  $(V_O + 2.5)\text{ V}$ . See the Application Information section for further guidance.
- (2) For output voltages less than 3.6 V, the maximum input voltage is  $10 \times V_O$ . See the Application Information section for further guidance.
- (3) The set-point voltage tolerance is affected by the tolerance and stability of  $R_{\text{SET}}$ . The stated limit is unconditionally met if  $R_{\text{SET}}$  has a tolerance of 1% with 100 ppm/°C or better temperature stability.
- (4) This control pin has an internal pullup, and if left open circuit, the module operates when input power is applied. The open-circuit voltage is typically 1.5 V. A small, low-leakage (< 100 nA) MOSFET is recommended for control. See the Application Information section for further guidance.
- (5) An external 2.2- $\mu\text{F}$  ceramic capacitor is required across the input ( $V_I$  and GND) for proper operation. Locate the capacitor close to the module.
- (6) 100  $\mu\text{F}$  of output capacitance is required for proper operation. See the Application Information section for further guidance.
- (7) This is the typical ESR for all the electrolytic (nonceramic) capacitance. Use 17 m $\Omega$  as the minimum when using maximum ESR values to calculate.

## ELECTRICAL CHARACTERISTICS

operating at 25°C free-air temperature,  $V_I = 24\text{ V}$ ,  $V_O = 12\text{ V}$ ,  $I_O = I_O(\text{max})$ ,  $C_I = 2 \times 4.7\text{ }\mu\text{F}$ ,  $C_O = 100\text{ }\mu\text{F}$  (unless otherwise noted)

PARAMETER		TEST CONDITIONS	PTN78000H			UNIT
			MIN	TYP	MAX	
$I_O$	Output current	$T_A = 85^\circ\text{C}$ , natural convection airflow	$V_O = 12\text{ V}$	0.1	1.5	A
			$V_O = 15\text{ V}$	0.1	1.5 <sup>(1)</sup>	
			$V_O = 22\text{ V}$	0.1	1 <sup>(1)</sup>	
$V_I$	Input voltage range	Over $I_O$ range	15 <sup>(2)</sup>		36	V
$V_O$	Set-point voltage tolerance	$T_A = 25^\circ\text{C}$			$\pm 2\%$ <sup>(3)</sup>	
	Temperature variation	$-40^\circ\text{C}$ to $+85^\circ\text{C}$		$\pm 0.5\%$		
	Line regulation	Over $V_I$ range		$\pm 10$		mV
	Load regulation	Over $I_O$ range		$\pm 10$		mV
	Total output voltage variation	Includes set point, line, load $-40^\circ\text{C} < T_A < 85^\circ\text{C}$			$\pm 3\%$ <sup>(3)</sup>	
$V_O$ Adj	Output voltage adjust range	$V_I < 19\text{ V}$	11.85		$V_I - 3$	V
		$19\text{ V} \leq V_I \leq 25\text{ V}$	11.85		$V_I - 4$	
		$V_I > 25\text{ V}$	11.85		22	
$\eta$	Efficiency	$V_I = 24\text{ V}$ , $R_{\text{SET}} = 383\text{ k}\Omega$ , $V_O = 12\text{ V}$		91%		
		$V_I = 24\text{ V}$ , $R_{\text{SET}} = 15\text{ k}\Omega$ , $V_O = 15\text{ V}$		93%		
		$V_I = 32\text{ V}$ , $R_{\text{SET}} = 95.3\text{ }\Omega$ , $V_O = 22\text{ V}$		94%		
	Output voltage ripple	20 MHz bandwidth		1% $V_O$		$V_{\text{PP}}$
$I_{O(\text{LIM})}$	Current limit threshold	$\Delta V_O = -50\text{ mV}$ , minimum $V_I$		$2 \times I_{O(\text{max})}$		A
	Transient response	1 A/ $\mu\text{s}$ load step from 50% to 100% $I_{O(\text{max})}$				
		Recovery time		200		$\mu\text{s}$
		$V_O$ over/undershoot		1		% $V_O$
UVLO	Undervoltage lockout	$V_I$ increasing		12.2		V
		$V_I$ decreasing		12		
	Inhibit control (pin 3)	Input high voltage ( $V_{\text{IH}}$ )	1		Open <sup>(4)</sup>	V
		Input low voltage ( $V_{\text{IL}}$ )	-0.1		0.3	
		Input low current ( $I_{\text{IL}}$ )		0.25		
$I_{\text{I(STBY)}}$	Input standby current	Pin 3 connected to GND		17		mA
$F_S$	Switching frequency	Over $V_I$ and $I_O$ ranges	440	550	660	kHz
$C_I$	External input capacitance	Ceramic	9.4 <sup>(5)</sup>			$\mu\text{F}$
$C_O$	External output capacitance	Nonceramic	100 <sup>(6)</sup>			$\mu\text{F}$
		Ceramic			200	
		Equiv. series resistance (nonceramic)	10 <sup>(7)</sup>			m $\Omega$
MTBF	Calculated reliability	Per Telcordia SR-332, 50% stress, $T_A = 40^\circ\text{C}$ , ground benign	8.9			$10^6\text{ Hr}$

- (1) The maximum output current is 1.5 A or the maximum output power is 22.5 W, whichever is less.
- (2) For output voltages less than 19 V, the minimum input voltage is 15 V or  $(V_O + 3)\text{ V}$ , whichever is greater. For output voltages of 19 V and higher, the minimum input voltage is  $(V_O + 4)\text{ V}$ . See the Application Information section for further guidance.
- (3) The set-point voltage tolerance is affected by the tolerance and stability of  $R_{\text{SET}}$ . The stated limit is unconditionally met if  $R_{\text{SET}}$  has a tolerance of 1% with 100 ppm/ $^\circ\text{C}$  or better temperature stability.
- (4) This control pin has an internal pullup, and if left open circuit, the module operates when input power is applied. The open-circuit voltage is typically 1.5 V. A small, low-leakage ( $< 100\text{ nA}$ ) MOSFET is recommended for control. See the Application Information section for further guidance.
- (5) Two external 4.7- $\mu\text{F}$  ceramic capacitors are required across the input ( $V_I$  and GND) for proper operation. Locate the capacitor close to the module.
- (6) 100  $\mu\text{F}$  of output capacitance is required for proper operation. See the Application Information section for further guidance.
- (7) This is the typical ESR for all the electrolytic (nonceramic) capacitance. Use 17 m $\Omega$  as the minimum when using maximum ESR values to calculate.

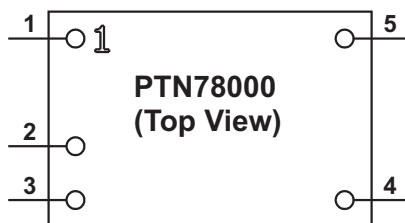
**PIN ASSIGNMENT**

**TERMINAL FUNCTIONS**

TERMINAL		I/O	DESCRIPTION
NAME	NO.		
GND	1	I/O	This is the common ground connection for the $V_I$ and $V_O$ power connections. It is also the 0 $V_{dc}$ reference for the <i>Inhibit</i> and $V_O$ <i>Adjust</i> control inputs.
$V_I$	2	I	The positive input voltage power node to the module, which is referenced to common GND.
Inhibit	3	I	The Inhibit pin is an open-collector/drain active-low input that is referenced to GND. Applying a low-level ground signal to this input disables the module's output and turns off the output voltage. When the Inhibit control is active, the input current drawn by the regulator is significantly reduced. If the Inhibit pin is left open-circuit, the module will produce an output whenever a valid input source is applied.
$V_O$ Adjust	4	O	A 1% resistor must be connected between this pin and GND (pin 1) to set the output voltage. If left open-circuit, the output voltage defaults to its minimum adjust value. The temperature stability of the resistor should be 100 ppm/°C (or better). The PTN78000W set-point range is 2.5 V to 12.6 V. The PTN78000H set-point range is 11.85 V to 22 V. The standard resistor value for a number of common output voltages is provided in the application information.
$V_O$	5	O	The regulated positive power output with respect to the GND node.

TYPICAL CHARACTERISTICS (7-V INPUT)<sup>(1)(2)</sup>

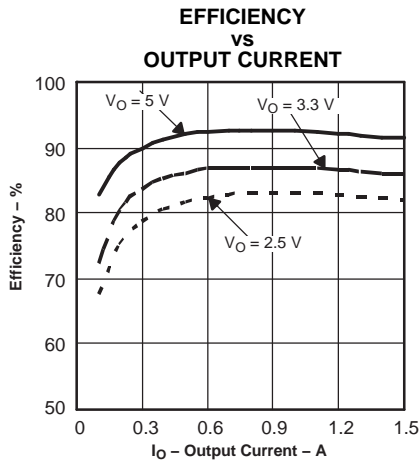

Figure 1.

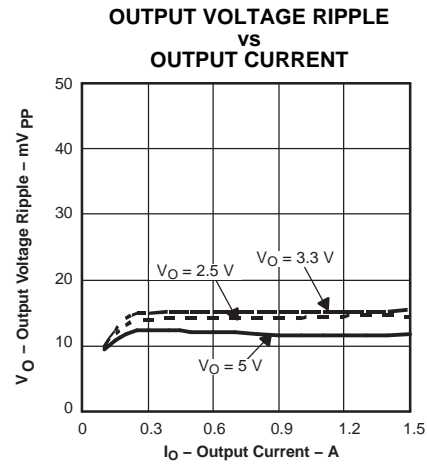

Figure 2.

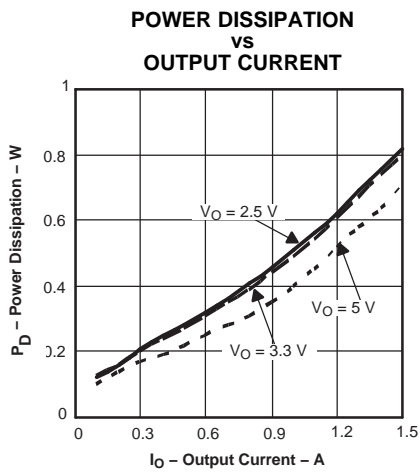

Figure 3.

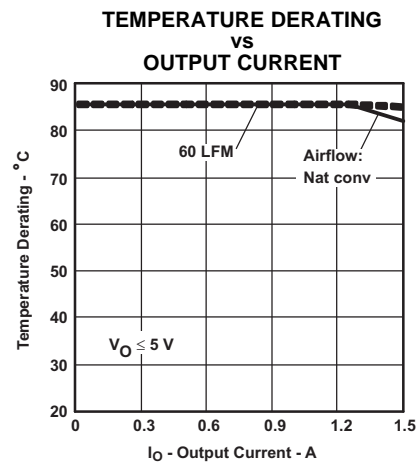

Figure 4.

- (1) The electrical characteristic data has been developed from actual products tested at 25° C. This data is considered typical for the converter. Applies to [Figure 1](#), [Figure 2](#), and [Figure 3](#).
- (2) The temperature derating curves represent the conditions at which internal components are at or below the manufacturer's maximum operating temperatures. Derating limits apply to modules soldered directly to a 100 mm x 100 mm double-sided PCB with 2 oz. copper. For surface mount packages, multiple vias (plated through holes) are required to add thermal paths around the power pins. Please refer to the mechanical specification for more information. Applies to [Figure 4](#).

TYPICAL CHARACTERISTICS (15-V INPUT)<sup>(1)(2)</sup>

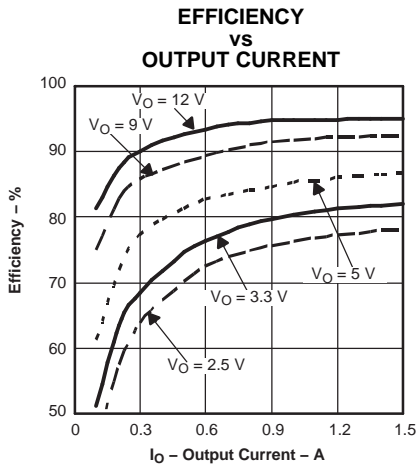

Figure 5.

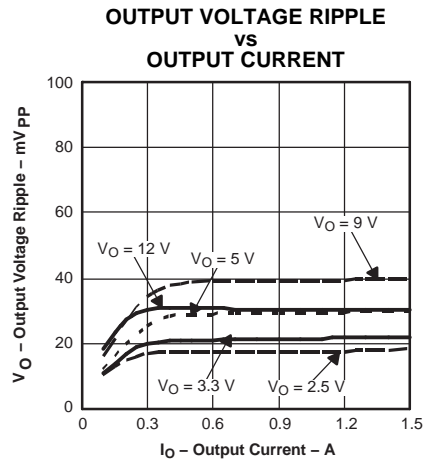

Figure 6.

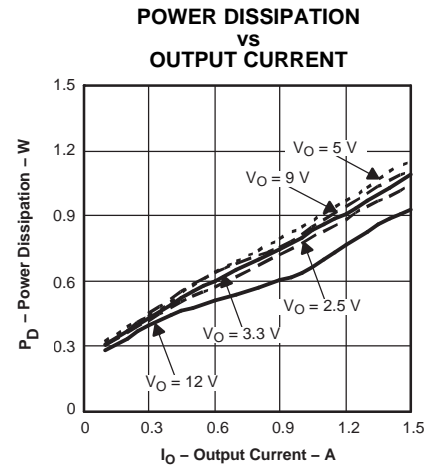

Figure 7.

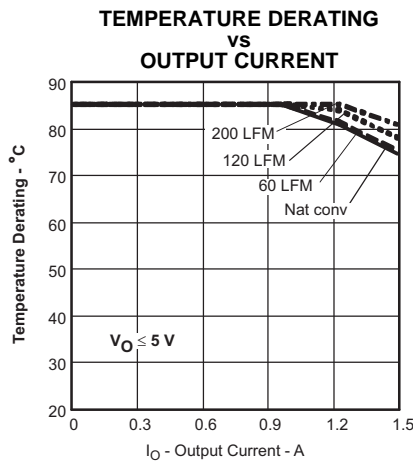

Figure 8.

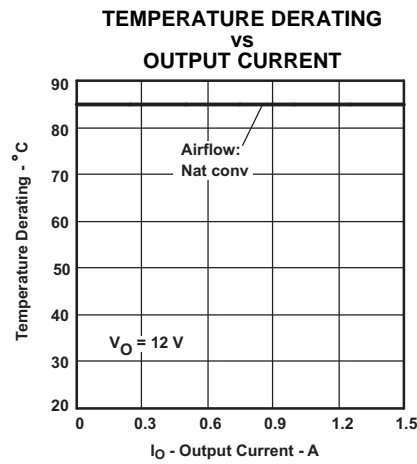

Figure 9.

- (1) The electrical characteristic data has been developed from actual products tested at 25° C. This data is considered typical for the converter. Applies to [Figure 5](#), [Figure 6](#), and [Figure 7](#).
- (2) The temperature derating curves represent the conditions at which internal components are at or below the manufacturer's maximum operating temperatures. Derating limits apply to modules soldered directly to a 100-mm x 100-mm, double-sided PCB with 2 oz. copper. For surface mount packages, multiple vias (plated through holes) are required to add thermal paths around the power pins. Please refer to the mechanical specification for more information. Applies to [Figure 8](#) and [Figure 9](#).

TYPICAL CHARACTERISTICS (24-V INPUT)<sup>(1)(2)</sup>

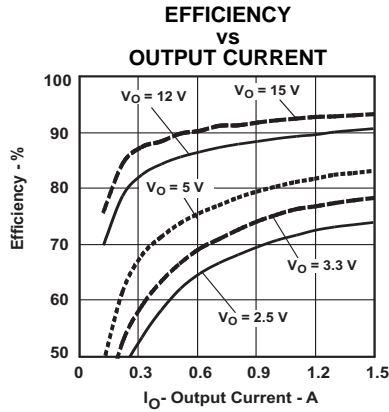

Figure 10.

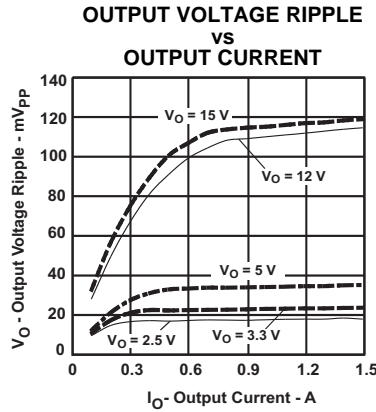

Figure 11.

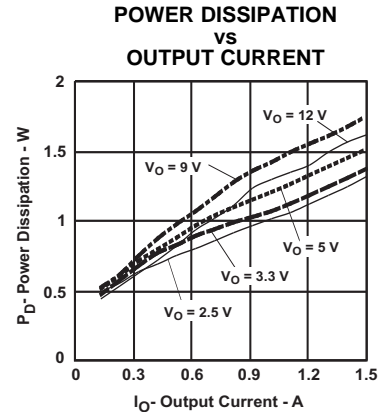

Figure 12.

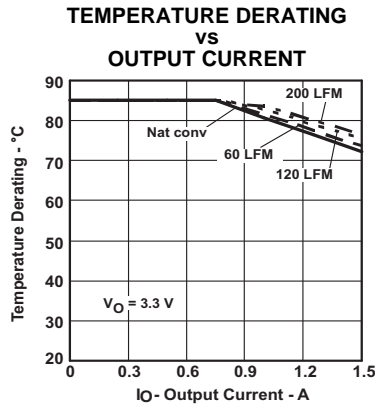

Figure 13.

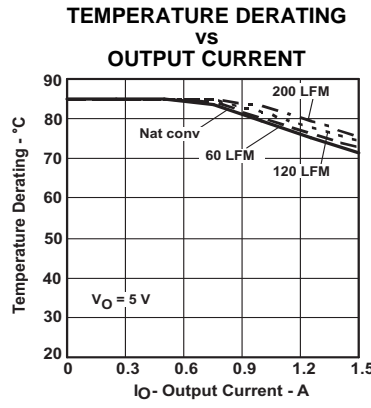

Figure 14.

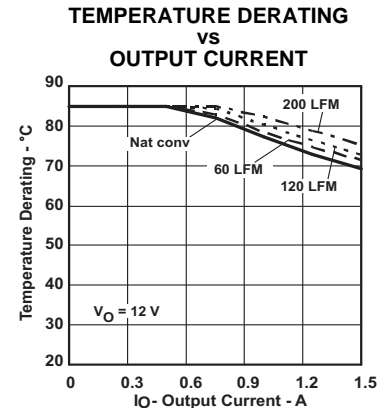

Figure 15.

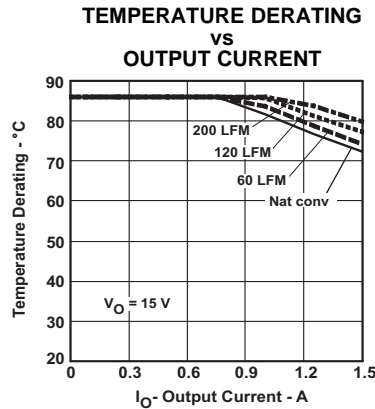

Figure 16.

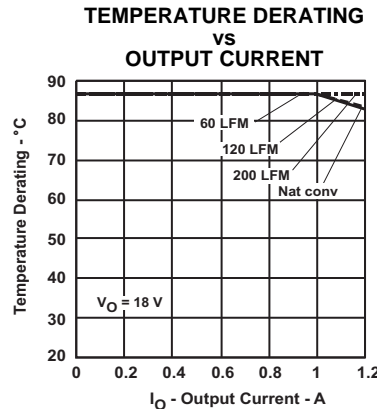

Figure 17.

- (1) The electrical characteristic data has been developed from actual products tested at 25° C. This data is considered typical for the converter. Applies to [Figure 10](#), [Figure 11](#), and [Figure 12](#).
- (2) The temperature derating curves represent the conditions at which internal components are at or below the manufacturer's maximum operating temperatures. Derating limits apply to modules soldered directly to a 100-mm x 100-mm, double-sided PCB with 2 oz. copper. For surface mount packages, multiple vias (plated through holes) are required to add thermal paths around the power pins. Please refer to the mechanical specification for more information. Applies to [Figure 13](#) through [Figure 17](#).



TYPICAL CHARACTERISTICS (32-V INPUT)<sup>(1)(2)</sup>

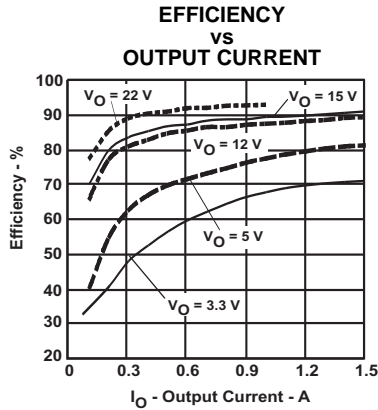

Figure 18.

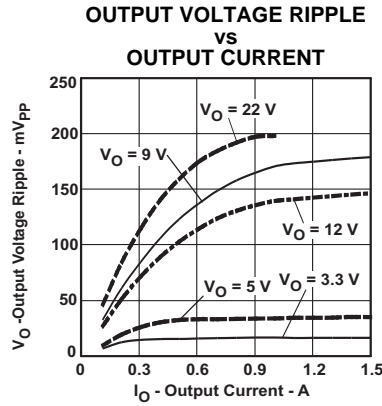

Figure 19.

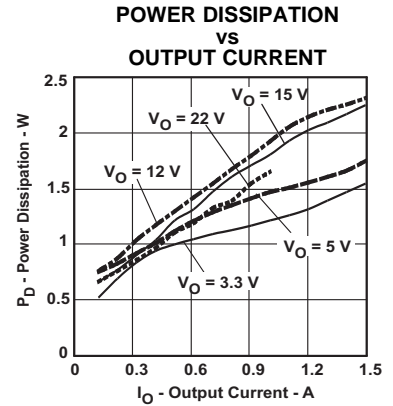

Figure 20.

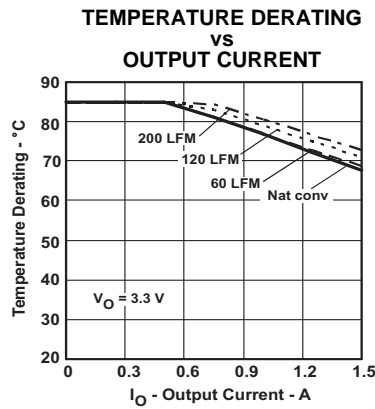

Figure 21.

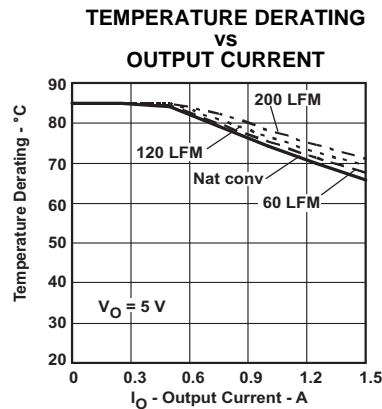

Figure 22.

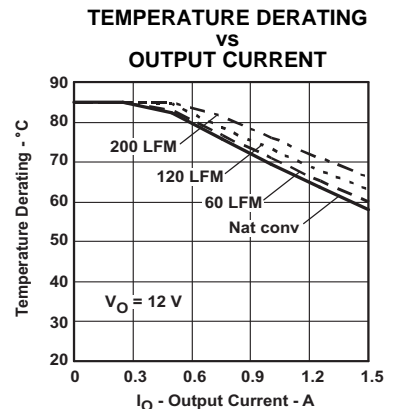

Figure 23.

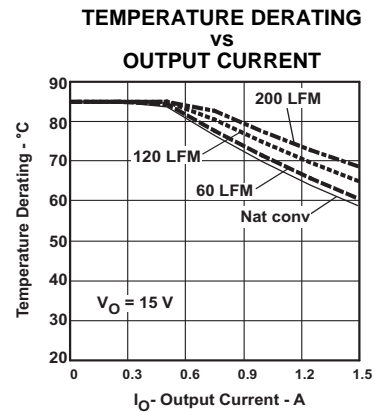

Figure 24.

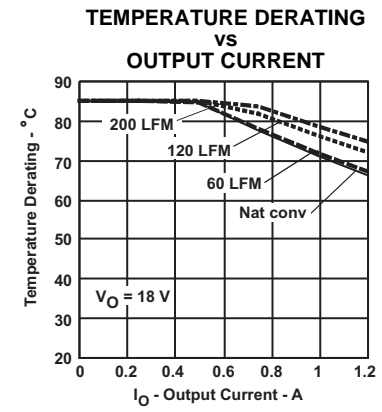

Figure 25.

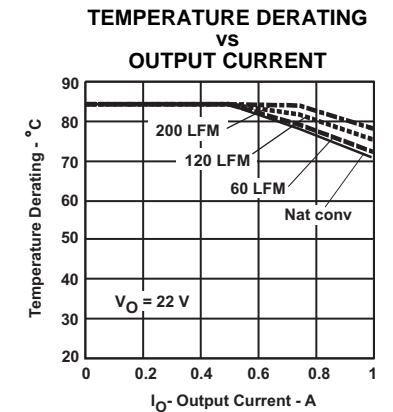

Figure 26.

- (1) The electrical characteristic data has been developed from actual products tested at 25° C. This data is considered typical for the converter. Applies to Figure 18, Figure 19, and Figure 20.
- (2) The temperature derating curves represent the conditions at which internal components are at or below the manufacturer's maximum operating temperatures. Derating limits apply to modules soldered directly to a 100-mm x 100-mm, double-sided PCB with 2 oz. copper. For surface mount packages, multiple vias (plated through holes) are required to add thermal paths around the power pins. Please refer to the mechanical specification for more information. Applies to Figure 21 through Figure 26.

## APPLICATION INFORMATION

### Adjusting the Output Voltage of the PTN78000 Wide-Output Adjust Power Modules

#### General

A resistor must be connected between the  $V_O$  *Adjust* control (pin 4) and *GND* (pin 1) to set the output voltage. The adjustment range is from 2.5 V to 12.6 V for PTN78000W. The adjustment range is from 11.85 V to 22 V for PTN78000H. If pin 4 is left open, the output voltage defaults to the lowest value.

Table 2 gives the preferred value of the external resistor for several standard voltages, with the actual output voltage that the value provides. For other output voltages, the value of the required resistor can be calculated using Equation 1, and the constants for the applicable product in Table 1. Alternatively,  $R_{SET}$  can be simply selected from the range of values given in Table 3. Figure 27 shows the placement of the required resistor.

$$R_{SET} = 54.9 \text{ k}\Omega \times \frac{1.25 \text{ V}}{V_O - V_{min}} - R_P \quad (1)$$

**Table 1.  $R_{SET}$  Formula Constants**

PRODUCT	$V_{MIN}$ (V)	$R_P$ (k $\Omega$ )
PTN780x0W	2.5	6.49
PTN780x0H	11.824	6.65

#### Input Voltage Considerations

The PTN78000 is a step-down switching regulator. In order that the output remains in regulation, the input voltage must exceed the output by a minimum differential voltage. (Please refer to the input voltage range requirements in the electrical characteristics table.)

Another consideration is the pulse width modulation (PWM) range of the regulator's internal control circuit. For stable operation, its operating duty cycle should not be lower than some minimum percentage. This defines the maximum advisable ratio between the regulator input and output voltage magnitudes.

As an example, for satisfactory performance, the operating input voltage range of the PTN78000x must adhere to the following requirements.

1. For PTN78000W output voltages lower than 10 V, the minimum input voltage is  $(V_O + 2 \text{ V})$  or 7 V, whichever is higher.
2. For PTN78000W output voltages equal to 10 V and higher, the minimum input voltage is  $(V_O + 2.5 \text{ V})$ .
3. For PTN78000W, the maximum input voltage is  $(10 \times V_O)$  or 36 V, whichever is less.
4. For PTN78000H output voltages lower than 19 V, the minimum input voltage is  $(V_O + 3 \text{ V})$  or 15 V, whichever is higher.
5. For PTN78000H output voltages equal to 19 V and higher, the minimum input voltage is  $(V_O + 4 \text{ V})$ .

As an example, Table 2 gives the operating input voltage range for the common output bus voltages. In addition, the Electrical Characteristics define the available output voltage adjust range for various input voltages.

**Table 2. Standard Values of R<sub>SET</sub> for Common Output Voltages**

PRODUCT	V <sub>O</sub> (Required) (V)	R <sub>SET</sub> (Standard Value) (kΩ)	V <sub>O</sub> (Actual) (V)	Operating V <sub>I</sub> Range (V)
PTN780x0W	2.5	Open	2.5	7 to 25
	3.3	78.7	3.306	7 to 33
	5	21	4.996	7 to 36
	12	0.732	12.002	14.5 to 36
PTN780x0H	12	383	12.000	15 to 36
	15	15	14.994	18 to 36
	18	4.42	18.023	21 to 36
	22	0.0953	21.998	26 to 36

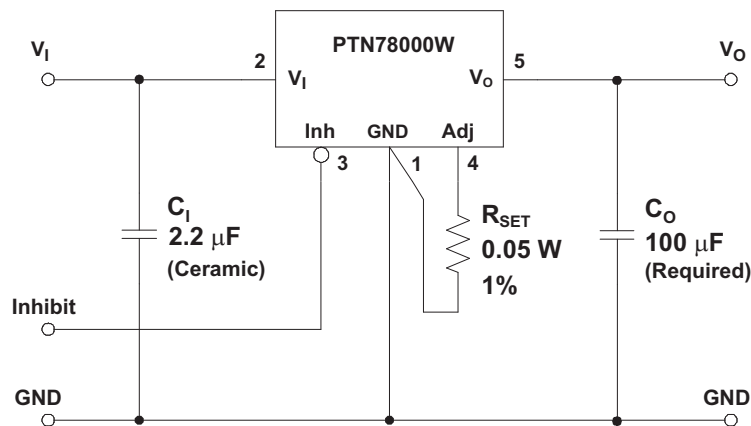

- (1) A 0.05-W rated resistor may be used. The tolerance should be 1%, with a temperature stability of 100 ppm/°C (or better). Place the resistor as close to the regulator as possible. Connect the resistor directly between pins 4 and 1 using dedicated PCB traces.
- (2) Never connect capacitors from V<sub>O</sub> Adjust to GND or V<sub>O</sub>. Any capacitance added to the V<sub>O</sub> Adjust pin affects the stability of the regulator.

**Figure 27. PTN78000W V<sub>O</sub>Adjust Resistor Placement**

**Table 3. PTN78000W Output Voltage Set-Point Resistor Values**

V <sub>O</sub> (V)	R <sub>SET</sub> (kΩ)	V <sub>O</sub> (V)	R <sub>SET</sub> (kΩ)	V <sub>O</sub> (V)	R <sub>SET</sub> (kΩ)	V <sub>O</sub> (V)	R <sub>SET</sub> (kΩ)
2.50	Open	3.7	50.7	6.1	12.6	9.0	4.07
2.55	1370	3.8	46.3	6.2	12.1	9.2	3.75
2.60	680	3.9	42.5	6.3	11.6	9.4	3.46
2.65	451	4.0	39.3	6.4	11.1	9.6	3.18
2.70	337	4.1	36.4	6.5	10.7	9.8	2.91
2.75	268	4.2	33.9	6.6	10.2	10.0	2.66
2.80	222	4.3	31.6	6.7	9.85	10.2	2.42
2.85	190	4.4	29.6	6.8	9.47	10.4	2.20
2.90	165	4.5	27.8	6.9	9.11	10.6	1.98
2.95	146	4.6	26.2	7.0	8.76	10.8	1.78
3.00	131	4.7	24.7	7.1	8.43	11.0	1.58
3.05	118	4.8	23.3	7.2	8.11	11.2	1.40
3.10	108	4.9	22.1	7.3	7.81	11.4	1.22
3.15	99.1	5.0	21.0	7.4	7.52	11.6	1.05
3.20	91.5	5.1	19.9	7.5	7.24	11.8	0.889
3.25	85.0	5.2	18.9	7.6	6.97	12.0	0.734
3.30	79.3	5.3	18.0	7.7	6.71	12.2	0.585
3.35	74.2	5.4	17.2	7.8	6.46	12.4	0.442
3.40	69.8	5.5	16.4	7.9	6.22	12.6	0.305
3.45	65.7	5.6	15.6	8.0	5.99		
3.50	62.1	5.7	15.0	8.2	5.55		
3.55	58.9	5.8	14.3	8.4	5.14		
3.60	55.9	5.9	13.7	8.6	4.76		
3.65	53.2	6.0	13.1	8.8	4.40		

**Table 4. PTN78000H Output Voltage Set-Point Resistor Values**

$V_O$ (V)	$R_{SET}$ (k $\Omega$ )	$V_O$ (V)	$R_{SET}$ (k $\Omega$ )	$V_O$ (V)	$R_{SET}$ (k $\Omega$ )
11.85	2633	13.50	34.3	17.20	6.12
11.90	896	13.65	30.9	17.40	5.66
11.95	538	13.80	28.1	17.60	5.23
12.00	383	13.95	25.6	17.80	4.83
12.10	242	14.10	23.5	18.00	4.46
12.15	204	14.25	21.6	18.20	4.11
12.20	176	14.40	19.9	18.40	3.79
12.25	154	14.55	18.5	18.60	3.48
12.30	138	14.70	17.2	18.80	3.19
12.35	124	14.85	16.0	19.00	2.91
12.40	113	15.00	14.9	19.20	2.65
12.45	103	15.15	13.9	19.40	2.41
12.50	94.9	15.30	13.1	19.60	2.18
12.55	87.9	15.45	12.3	19.80	1.95
12.60	81.8	15.60	11.5	20.00	1.74
12.65	76.4	15.75	10.8	20.20	1.54
12.70	71.7	15.90	10.2	20.40	1.35
12.75	67.5	16.05	9.59	20.60	1.17
12.80	63.7	16.20	9.03	20.80	0.995
12.85	60.2	16.35	8.51	21.00	0.829
12.90	57.1	16.50	8.03	21.20	0.669
12.95	54.3	16.65	7.57	21.40	0.516
13.00	51.7	16.80	7.14	21.80	0.229
13.05	49.3	17.10	6.36	22.00	0.09

## CAPACITOR RECOMMENDATIONS FOR PTN78000 WIDE-OUTPUT ADJUST POWER MODULES

### PTN78000W Input Capacitor

The minimum requirement for the input of PTN78000W is 2.2  $\mu\text{F}$  of ceramic capacitance. The dielectric may be either an X5R or X7R temperature characteristic. Ceramic capacitors should be located within 0.5 inch (1,27 cm) of the regulator input pins. Electrolytic capacitors can be used at the input, but only in addition to the required ceramic capacitance. The minimum ripple current rating for any nonceramic capacitance must be at least 650 mArms. The ripple current rating of electrolytic capacitors is a major consideration when they are used at the input. This ripple current requirement can be reduced by placing more ceramic capacitors at the input, in addition to the minimum required capacitance.

Tantalum capacitors are not recommended for use at the input bus, as none were found to meet the minimum voltage rating of 2 x (maximum dc voltage + ac ripple). The 2x rating is standard practice for regular tantalum capacitors to ensure reliability. Polymer-tantalum capacitors are more reliable and are available with a maximum rating of typically 20 V. These can be used with input voltages up to 16 V.

### PTN78000H Input Capacitor

The minimum requirement for the input of PTN78000H is 2 x 4.7  $\mu\text{F}$  of ceramic capacitance. The dielectric may be either an X5R or X7R temperature characteristic. Ceramic capacitors should be located within 0.5 inch (1,27 cm) of the regulator input pins. Electrolytic capacitors can be used at the input, but only in addition to the required ceramic capacitance. The minimum ripple current rating for any nonceramic capacitance must be at least 350 mArms. The ripple current rating of electrolytic capacitors is a major consideration when they are used at the input. This ripple current requirement can be reduced by placing more ceramic capacitors at the input, in addition to the minimum required capacitance.

Tantalum capacitors are not recommended for use at the input bus, as none were found to meet the minimum voltage rating of 2 x (maximum dc voltage + ac ripple). The 2x rating is standard practice for regular tantalum capacitors to ensure reliability. Polymer-tantalum capacitors are more reliable and are available with a maximum rating of typically 20 V. These can be used with input voltages up to 16 V.

### PTN78000W and PTN78000H Output Capacitors

The minimum capacitance required to insure stability is a 100  $\mu\text{F}$ . Either ceramic or electrolytic-type capacitors can be used. The minimum ripple current rating for the nonceramic capacitance must be at least 150 mA rms. The stability of the module and voltage tolerances will be compromised if the capacitor is not placed near the output bus pins. A high-quality, computer-grade electrolytic capacitor should be adequate. A ceramic capacitor can be also be located within 0.5 inch (1,27 cm) of the output pin.

For applications with load transients (sudden changes in load current), the regulator response improves with additional capacitance. Additional electrolytic capacitors should be located close to the load circuit. These capacitors provide decoupling over the frequency range, 2 kHz to 150 kHz. Aluminum electrolytic capacitors are suitable for ambient temperatures above 0°C. For operation below 0°C, tantalum or OS-CON type capacitors are recommended. When using one or more nonceramic capacitors, the calculated equivalent ESR should be no lower than 10 m $\Omega$  (17 m $\Omega$  using the manufacturer's maximum ESR for a single capacitor). A list of capacitors and vendors are identified in [Table 5](#) and [Table 6](#), the recommended capacitor tables.

### Ceramic Capacitors

Above 150 kHz the performance of aluminum electrolytic capacitors becomes less effective. To further reduce the reflected input ripple current, or the output transient response, multilayer ceramic capacitors must be added. Ceramic capacitors have low ESR and their resonant frequency is higher than the bandwidth of the regulator. When placed at the output, their combined ESR is not critical as long as the total value of ceramic capacitance does not exceed 200  $\mu\text{F}$ .

## Tantalum Capacitors

Tantalum type capacitors may be used at the output, and are recommended for applications where the ambient operating temperature can be less than 0°C. The AVX TPS, Sprague 593D/594/595, and Kemet T495/T510/T520 capacitors series are suggested over many other tantalum types due to their rated surge, power dissipation, and ripple current capability. As a caution, many general-purpose tantalum capacitors have considerably higher ESR, reduced power dissipation, and lower ripple current capability. These capacitors are also less reliable as they have lower power dissipation and surge current ratings. Tantalum capacitors that do not have a stated ESR or surge current rating are not recommended for power applications. When specifying OS-CON and polymer tantalum capacitors for the output, the minimum ESR limit is encountered well before the maximum capacitance value is reached.

## Capacitor Table

The capacitor table, [Table 5](#) and [Table 6](#), identifies the characteristics of capacitors from various vendors with acceptable ESR and ripple current (rms) ratings. The recommended number of capacitors required at both the input and output buses is identified for each capacitor type. This is not an extensive capacitor list. Capacitors from other vendors are available with comparable specifications. Those listed are for guidance. The rms rating and ESR (at 100 kHz) are critical parameters necessary to insure both optimum regulator performance and long capacitor life.

## Designing for Load Transients

The transient response of the dc/dc converter has been characterized using a load transient with a di/dt of 1 A/μs. The typical voltage deviation for this load transient is given in the data sheet specification table using the required value of output capacitance. As the di/dt of a transient is increased, the response of a converter's regulation circuit ultimately depends on its output capacitor decoupling network. This is an inherent limitation of any dc/dc converter once the speed of the transient exceeds its bandwidth capability. If the target application specifies a higher di/dt or lower voltage deviation, the requirement can only be met with additional output capacitor decoupling. In these cases, special attention must be paid to the type, value, and ESR of the capacitors selected.

If the transient performance requirements exceed those specified in the data sheet, the selection of output capacitors becomes more important. Review the minimum ESR in the characteristic data sheet for details on the capacitance maximum.

**Table 5. Recommended Input/Output Capacitors (PTN78000W)**

CAPACITOR VENDOR/ COMPONENT SERIES	CAPACITOR CHARACTERISTICS					QUANTITY		VENDOR NUMBER
	WORKING VOLTAGE (V)	VALUE (μF)	EQUIVALENT SERIES RESISTANCE (ESR) (Ω)	85°C MAXIMUM RIPPLE CURRENT (I <sub>rms</sub> ) (mA)	PHYSICAL SIZE (mm)	INPUT BUS	OUTPUT BUS	
Panasonic								
FC (Radial)	50	180	0.119	850	10 x 16	1	1	EEUFC1H181
FC (SMD)	3	100	0.150	670	10 x 10,2	1 <sup>(1)</sup>	1	EEVFC1V101P
United Chemi-Con								
PXA (SMD)	16	180	0.016	4360	8 x 12	1 <sup>(1)</sup>	1	PXA16VC180MF60
LXZ	50	120	0.160	620 x 2	10 x 12,5	2	1	LXZ50VB121M10X12LL
MVY (SMD)	50	100	0.300	500	10 x 10	1 <sup>(1)</sup>	1	MVY50VC101M10X10TP (V <sub>O</sub> ≤ 5.5 V)
Nichicon								
UWG (SMD)	50	100	0.300	500	10 x 10	1 <sup>(1)</sup>	1	UWG1H101MNR1GS (V <sub>O</sub> ≤ 5.5 V)
F55 (Tantalum)	10	100	0.055	2000	7,7 x 4,3	N/R <sup>(1)</sup>	≤ 3 <sup>(2)</sup>	F551A107MN (V <sub>O</sub> ≤ 5 V)
HD (Radial)	50	100	0.074	724	8 x 11,5	1	1	UHD1H101MPR

(1) The voltage rating of the input capacitor must be selected for the desired operating input voltage range of the regulator. To operate the regulator at a higher input voltage, select a capacitor with the next higher voltage rating.

(2) The maximum voltage rating of the capacitor must be selected for the desired set-point voltage (V<sub>O</sub>). To operate at a higher output voltage, select a capacitor with a higher voltage rating.

**Table 5. Recommended Input/Output Capacitors (PTN78000W) (continued)**

CAPACITOR VENDOR/ COMPONENT SERIES	CAPACITOR CHARACTERISTICS					QUANTITY		VENDOR NUMBER
	WORKING VOLTAGE (V)	VALUE ( $\mu$ F)	EQUIVALENT SERIES RESISTANCE (ESR) ( $\Omega$ )	85°C MAXIMUM RIPPLE CURRENT ( $I_{rms}$ ) (mA)	PHYSICAL SIZE (mm)	INPUT BUS	OUTPUT BUS	
Sanyo OS-CON								
SVP (SMD)	20	100	0.024	2500	8 x 12	1 <sup>(3)</sup>	$\leq 2$	20SVP100M ( $V_I$ and $V_O \leq 16$ V)
SP	16	100	0.032	2890	10 x 5	1 <sup>(3)</sup>	$\leq 2$	16SP100M ( $V_I$ and $V_O \leq 14$ V)
AVX Tantalum TPS (SMD)	20	100	0.085	1543	7,3 x 4,3 x 4,1	N/R <sup>(4)</sup>	$\leq 3$	TPSV107M020R0085 ( $V_O \leq 10$ V)
	20	100	0.200	> 817	7,3 x 4,3 x 4,1	N/R <sup>(4)</sup>	$\leq 3$	TPSE107M020R0200 ( $V_O \leq 10$ V)
Murata X5R Ceramic	6.3	100	0.002	>1000	3225	N/R <sup>(3)</sup>	$\leq 2$	GRM32ER60J107M ( $V_O \leq 5.5$ V)
TDK X5R Ceramic	6.3	100	0.002	>1000	3225	N/R <sup>(3)</sup>	$\leq 2$	C3225X5R0J107MT ( $V_O \leq 5.5$ V)
Murata X5R Ceramic	16	47	0.002	>1000	3225	1 <sup>(3)</sup>	$\leq 4$	GRM32ER61C476M ( $V_I$ and $V_O \leq 13.5$ V)
Kemet X5R Ceramic	6.3	47	0.002	>1000	3225	N/R <sup>(3)</sup>	$\leq 4$	C1210C476K9PAC ( $V_O \leq 5.5$ V)
TDK X5R Ceramic	6.3	47	0.002	>1000	3225	N/R <sup>(3)</sup>	$\leq 4$	C3225X5R0J476MT ( $V_O \leq 5.5$ V)
Murata X5R Ceramic	6.3	47	0.002	>1000	3225	N/R <sup>(3)</sup>	$\leq 4$	GRM422X5R476M6.3 ( $V_O \leq 5.5$ V)
TDK X7R Ceramic	25	2.2	0.002	>1000	SMD	$\geq 1$ <sup>(5)</sup>	1	C3225X7R1E225KT/MT ( $V_I$ and $V_O \leq 20$ V)
Murata X7R Ceramic	25	2.2	0.002	>1000	3225	$\geq 1$ <sup>(5)</sup>	1	GRM32RR71E225K ( $V_I$ and $V_O \leq 20$ V)
Kemet X7R Ceramic	25	2.2	0.002	>1000	3225	$\geq 1$ <sup>(4)</sup>	1	C1210C225K3RAC ( $V_I$ and $V_O \leq 20$ V)
AVX X7R Ceramic	25	2.2	0.002	>1000		$\geq 1$ <sup>(4)</sup>	1	12103C225KAT2A ( $V_I$ and $V_O \leq 20$ V)
Kemet X7R Ceramic	50	1	0.002	>1000	SMD	$\geq 2$ <sup>(6)</sup>	1	C1210C105K5RAC
Murata X7R Ceramic	50	4.7	0.002	>1000		$\geq 1$	1	GRM32ER71H475KA88L
TDK X7R Ceramic	50	2.2	0.002	>1000		$\geq 1$	1	C3225X7R1H225KT
Murata X7R Ceramic	50	1	0.002	>1000	3225	$\geq 2$ <sup>(6)</sup>	1	GRM32RR71H105KA01L
TDK X7R Ceramic	50	1	0.002	>1000	3225	$\geq 2$ <sup>(6)</sup>	1	C3225X7R1H105KT
Kemet Radial Through-hole	50	1	0.002	>1000	5,1 x 7,6 x 9,1	$\geq 2$ <sup>(6)</sup>	1	C330C105K5R5CA
Murata Radial Through-hole	50	2.2	0.004	>1000	10 x 10	1	1	RPER71H2R2KK6F03

- (3) The voltage rating of the input capacitor must be selected for the desired operating input voltage range of the regulator. To operate the regulator at a higher input voltage, select a capacitor with the next higher voltage rating.
- (4) Not recommended (N/R). The voltage rating does not meet the minimum operating limits in most applications.
- (5) The maximum rating of the ceramic capacitor limits the regulator's operating input voltage to 20 V. Select an alternative ceramic component to operate at a higher input voltage.
- (6) A total capacitance of 2  $\mu$ F is an acceptable replacement value for a single 2.2- $\mu$ F ceramic capacitor.



**Table 6. Recommended Input/Output Capacitors (PTN78000H)**

CAPACITOR VENDOR/ COMPONENT SERIES	CAPACITOR CHARACTERISTICS					QUANTITY		VENDOR NUMBER
	WORKING VOLTAGE (V)	VALUE ( $\mu$ F)	EQUIVALENT SERIES RESISTANCE (ESR) ( $\Omega$ )	85°C MAXIMUM RIPPLE CURRENT ( $I_{rms}$ ) (mA)	PHYSICAL SIZE (mm)	INPUT BUS	OUTPUT BUS	
Panasonic								
FC (Radial)	50	100	0.162	615	10 x 12,5	1	1	EEUFC1H1081
FK (SMD)	50	150	0.180	670	10 x 10,2	1	1	EEVFK1H151P
FC (SMD)	35	100	0.150	670	10 x 10,2	1 <sup>(1)</sup>	1	EEVFC1V101P ( $V_I \leq 32$ V)
United Chemi-Con								
PS (Radial)	25	100	0.020	4320	8 x 12,5	1 <sup>(1)</sup>	$\leq 1$	25PS100MJ12 ( $V_I$ and $V_O \leq 22$ V)
LXZ	50	120	0.160	620	10 x 12,5	1	1	LXZ50VB121M10X12LL
MVY (SMD)	50	100	0.300	500	10 x 10	1	1	MVY50VC101M10X10TP
Nichicon								
UWG (SMD)	50	100	0.300	500	10 x 10	1	1	UWG1H101MNR1GS
F55 (Tantalum)	10	100	0.055	2000	7,7 x 4,3	N/R <sup>(1)</sup>	$\leq 3$ <sup>(2)</sup>	F551A107MN ( $V_O \leq 5$ V)
HD (Radial)	50	100	0.074	724	8 x 11,5	1	1	UHD1H101MPR
Sanyo OS-CON								
SVP (SMD)	20	100	0.024	2500	8 x 12	1 <sup>(1)</sup>	$\leq 2$	20SVP100M ( $V_I$ and $V_O \leq 16$ V)
SP	20	120	0.024	3110	8 x 10,5	1 <sup>(1)</sup>	$\leq 2$	20SP120M ( $V_I$ and $V_O \leq 16$ V)
Murata X5R Ceramic	16	47	0.002	>1000	3225	1 <sup>(1)</sup>	1	GRM32ER61C476M ( $V_O \leq 13.5$ V)
TDK X7R Ceramic	25	2.2	0.002	>1000	SMD	$\geq 5$ <sup>(3)</sup>	1	C3225X7R1E225KT/MT ( $V_I$ and $V_O \leq 20$ V)
Murata X7R Ceramic	25	2.2	0.002	>1000	3225	$\geq 5$ <sup>(3)</sup>	1	GRM32RR71E225K ( $V_I$ and $V_O \leq 20$ V)
Kemet X7R Ceramic	25	2.2	0.002	>1000	3225	$\geq 5$ <sup>(3)</sup>	1	C1210C225K3RAC ( $V_I$ and $V_O \leq 20$ V)
AVX X7R Ceramic	25	2.2	0.002	>1000		$\geq 5$ <sup>(3)</sup>	1	12103C225KAT2A ( $V_I$ and $V_O \leq 20$ V)
Kemet X7R Ceramic	50	1	0.002	>1000	SMD	$\geq 9$ <sup>(4)</sup>	1	C1210C105K5RAC
Murata X7R Ceramic	50	4.7	0.002	>1000		$\geq 2$	1	GRM32ER71H475KA88L
TDK X7R Ceramic	50	3.3	0.002	>1000		$\geq 3$	1	CKG45NX7R1H335M
Kemet Radial Through-hole	50	4.7	0.003	>1000	5,1 x 7,6 x 9,1	$\geq 2$	1	C350C475K5R5CA
Murata Radial Through-hole	50	3.3	0.003	>1000	12,5 x 12,5	3	1	RPER71H3R3KK6F03

- (1) The voltage rating of the input capacitor must be selected for the desired operating input voltage range of the regulator. To operate the regulator at a higher input voltage, select a capacitor with the next higher voltage rating.
- (2) The maximum voltage rating of the capacitor must be selected for the desired set-point voltage ( $V_O$ ). To operate at a higher output voltage, select a capacitor with a higher voltage rating.
- (3) The maximum rating of the ceramic capacitor limits the regulator's operating input voltage to 20 V. Select an alternative ceramic component to operate at a higher input voltage.
- (4) A total capacitance of 2  $\mu$ F is an acceptable replacement value for a single 2.2- $\mu$ F ceramic capacitor

## Power-Up Characteristics

When configured per the standard application, the PTN78000 power module produces a regulated output voltage following the application of a valid input source voltage. During power up, internal soft-start circuitry slows the rate that the output voltage rises, thereby limiting the amount of in-rush current that can be drawn from the input source. The soft-start circuitry introduces a short time delay (typically 5 ms–10 ms) into the power-up characteristic. This is from the point that a valid input source is recognized. Figure 28 shows the power-up waveforms for a PTN78000W, operating from a 12-V input and with the output voltage adjusted to 5 V. The waveforms were measured with a 1.5-A resistive load.

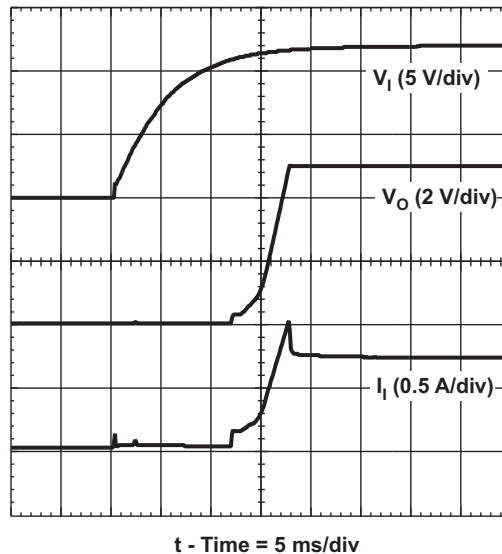

Figure 28. Power-Up Waveforms

## Undervoltage Lockout

The undervoltage lockout (UVLO) circuit prevents the module from attempting to power up until the input voltage is above the UVLO threshold. This prevents the module from drawing excessive current from the input source at power up. Below the UVLO threshold, the module is held off.

## Current Limit Protection

The PTN78000 modules protect against load faults with a continuous current limit characteristic. Under a load fault condition, the output current cannot exceed the current limit value. Attempting to draw current that exceeds the current limit value causes the module to progressively reduce its output voltage. Current is continuously supplied to the fault until it is removed. On removal of the fault, the output voltage promptly recovers. When limiting output current, the regulator experiences higher power dissipation, which increases its temperature. If the temperature increase is excessive, the module's overtemperature protection begins to periodically turn the output voltage completely off.

## Overtemperature Protection

A thermal shutdown mechanism protects the module's internal circuitry against excessively high temperatures. A rise in temperature may be the result of a drop in airflow, a high ambient temperature, or a sustained current-limit condition. If the junction temperature of the internal control IC rises excessively, the module turns off, reducing the output voltage to zero. The module instantly restarts when the sensed temperature decreases by a few degrees.

**Note:** *Overtemperature protection is a last resort mechanism to prevent damage to the module. It should not be relied on as permanent protection against thermal stress. Always operate the module within its temperature derated limits, for the worst-case operating conditions of output current, ambient temperature, and airflow. Operating the module above these limits, albeit below the thermal shutdown temperature, reduces the long-term reliability of the module.*

## Output On/Off Inhibit

For applications requiring output voltage on/off control, the PTN78000 power module incorporates an output on/off Inhibit control (pin 3). The inhibit feature can be used wherever there is a requirement for the output voltage from the regulator to be turned off.

The power module functions normally when the Inhibit pin is left open-circuit, providing a regulated output whenever a valid source voltage is connected to  $V_I$  with respect to GND. Figure 29 shows the the circuit used to demonstrate the inhibit function. Note the discrete transistor (Q1). Turning Q1 on applies a low voltage to the *Inhibit* control pin and turns the module off. The output voltage decays as the load circuit discharges the capacitance. The current drawn at the input is reduced to typically 17 mA. If Q1 is then turned off, the module executes a soft-start power up. A regulated output voltage is produced within 20 ms Figure 30 shows the typical rise in the output voltage, following the turn off of Q1. The turn off of Q1 corresponds to the fall in the waveform,  $Q1 V_{GS}$ . The waveforms were measured with a 1.5-A resistive load.

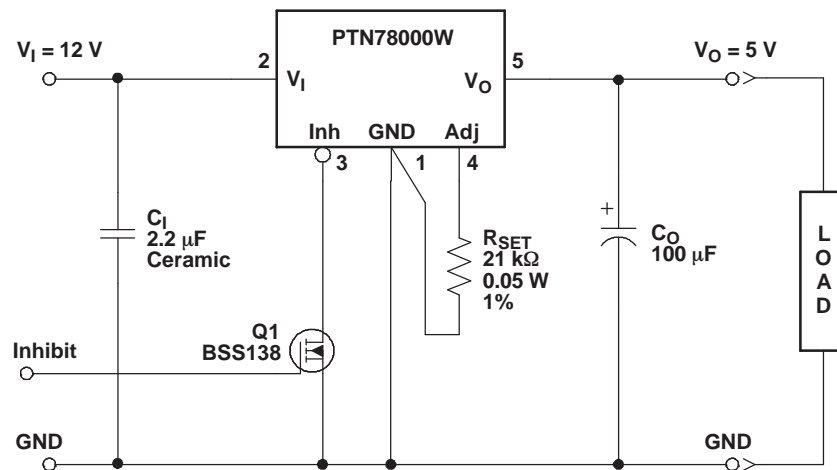

Figure 29. On/Off Inhibit Control Circuit

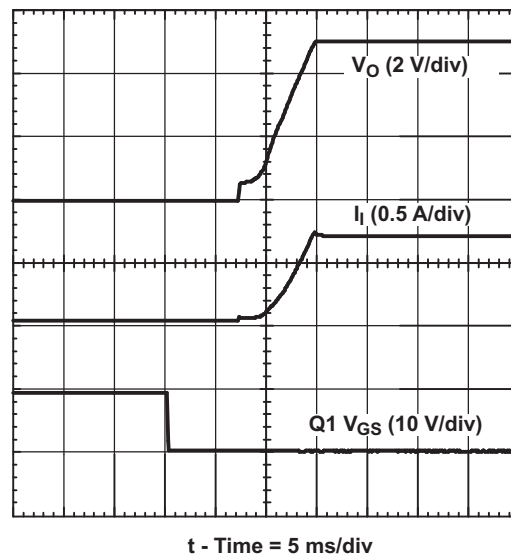

Figure 30. Power Up Response From Inhibit Control

## Optional Input/Output Filters

Power modules include internal input and output ceramic capacitors in all their designs. However, some applications require much lower levels of either input reflected or output ripple/noise. This application note describes various filters and design techniques found to be successful in reducing both input and output ripple/noise.

### Input/Output Capacitors

The easiest way to reduce output ripple and noise is to add one or more 1- $\mu\text{F}$  ceramic capacitors, such as C4 shown in Figure 31. Ceramic capacitors should be placed close to the output power terminals. A single 1- $\mu\text{F}$  capacitor reduces the output ripple/noise by 10% to 30% for modules with a rated output current of less than 3 A. (Note: C3 is recommended to improve the regulators transient response and does not reduce output ripple and noise.)

Switching regulators draw current from the input line in pulses at their operating frequency. The amount of reflected (input) ripple/noise generated is directly proportional to the equivalent source impedance of the power source including the impedance of any input lines. The addition of C1, minimum 1- $\mu\text{F}$  ceramic capacitor, near the input power pins, reduces reflected conducted ripple/noise by 30% to 50%.

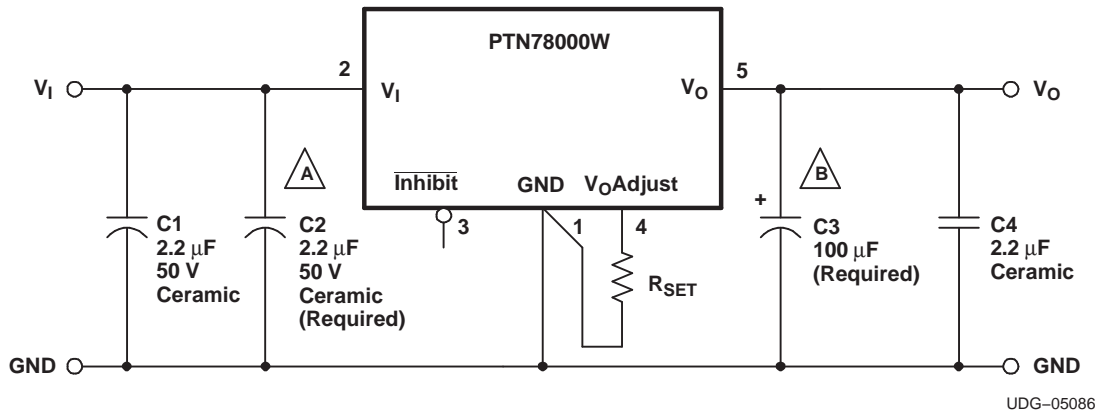
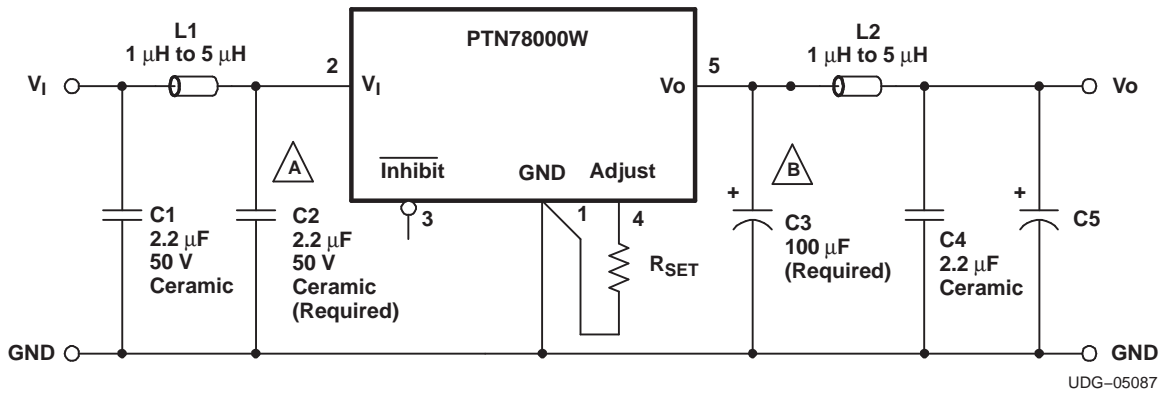

Figure 31. Adding High-Frequency Bypass Capacitors To The Input and Output

### $\pi$ Filters

If a further reduction in ripple/noise level is required for an application, higher order filters must be used. A  $\pi$  ( $\pi$ ) filter, employing a ferrite bead (Fair-Rite part number 2673000701 or equivalent) in series with the input or output terminals of the regulator reduces the ripple/noise by at least 20 db (see Figure 32 and Figure 33). In order for the inductor to be effective in reduction of ripple and noise ceramic capacitors are required. (Note: see Capacitor Recommendations for the PTN78000W for additional information on vendors and component suggestions.)

These inductors plus ceramic capacitors form an excellent filter because of the rejection at the switching frequency (650 kHz - 1 MHz). The placement of this filter is critical. It must be located as close as possible to the input or output pins to be effective. The ferrite bead is small (12,5 mm x 3 mm), easy to use, low cost, and has low dc resistance. Fair-Rite also manufactures a surface-mount bead (part number 2773021447), through hole (part number 2673000701) rated to 5 A, but in this application, it is effective to 5 A on the output bus. Inductors in the range of 1  $\mu\text{H}$  to 5  $\mu\text{H}$  can be used in place of the ferrite inductor bead.



UDG-05087

Figure 32. Adding  $\pi$  Filters ( $I_o \leq 3$  A)

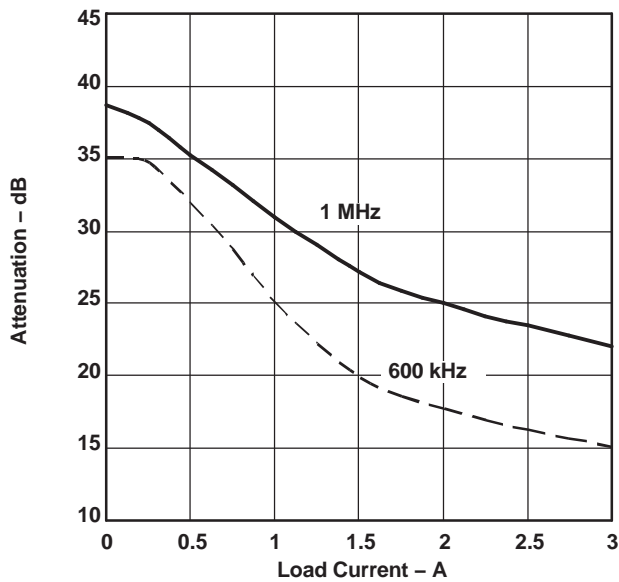

Figure 33.  $\pi$ -Filter Attenuation vs. Load Current

**PACKAGING INFORMATION**

Orderable Device	Status <sup>(1)</sup>	Package Type	Package Drawing	Pins	Package Qty	Eco Plan <sup>(2)</sup>	Lead/Ball Finish	MSL Peak Temp <sup>(3)</sup>	Samples (Requires Login)
PTN78000HAH	ACTIVE	Through-Hole Module	EUS	5	56	Pb-Free (RoHS)	SN	N / A for Pkg Type	<a href="#">Request Free Samples</a>
PTN78000HAS	ACTIVE	Surface Mount Module	EUT	5	49	TBD	SNPB	Level-1-235C-UNLIM/ Level-3-260C-168HRS	<a href="#">Request Free Samples</a>
PTN78000HAST	ACTIVE	Surface Mount Module	EUT	5	250	TBD	SNPB	Level-1-235C-UNLIM/ Level-3-260C-168HRS	<a href="#">Purchase Samples</a>
PTN78000HAZ	ACTIVE	Surface Mount Module	EUT	5	49	Pb-Free (RoHS)	SNAGCU	Level-3-260C-168 HR	<a href="#">Request Free Samples</a>
PTN78000HAZT	ACTIVE	Surface Mount Module	EUT	5	250	Pb-Free (RoHS)	SNAGCU	Level-3-260C-168 HR	<a href="#">Purchase Samples</a>
PTN78000WAH	ACTIVE	Through-Hole Module	EUS	5	56	Pb-Free (RoHS)	SN	N / A for Pkg Type	<a href="#">Request Free Samples</a>
PTN78000WAS	ACTIVE	Surface Mount Module	EUT	5	49	TBD	SNPB	Level-1-235C-UNLIM/ Level-3-260C-168HRS	<a href="#">Request Free Samples</a>
PTN78000WAST	ACTIVE	Surface Mount Module	EUT	5	250	TBD	SNPB	Level-1-235C-UNLIM/ Level-3-260C-168HRS	<a href="#">Purchase Samples</a>
PTN78000WAZ	ACTIVE	Surface Mount Module	EUT	5	49	Pb-Free (RoHS)	SNAGCU	Level-3-260C-168 HR	<a href="#">Request Free Samples</a>
PTN78000WAZT	ACTIVE	Surface Mount Module	EUT	5	250	Pb-Free (RoHS)	SNAGCU	Level-3-260C-168 HR	<a href="#">Purchase Samples</a>

<sup>(1)</sup> The marketing status values are defined as follows:

**ACTIVE:** Product device recommended for new designs.

**LIFEBUY:** TI has announced that the device will be discontinued, and a lifetime-buy period is in effect.

**NRND:** Not recommended for new designs. Device is in production to support existing customers, but TI does not recommend using this part in a new design.

**PREVIEW:** Device has been announced but is not in production. Samples may or may not be available.

**OBSOLETE:** TI has discontinued the production of the device.

<sup>(2)</sup> Eco Plan - The planned eco-friendly classification: Pb-Free (RoHS), Pb-Free (RoHS Exempt), or Green (RoHS & no Sb/Br) - please check <http://www.ti.com/productcontent> for the latest availability information and additional product content details.

**TBD:** The Pb-Free/Green conversion plan has not been defined.

**Pb-Free (RoHS):** TI's terms "Lead-Free" or "Pb-Free" mean semiconductor products that are compatible with the current RoHS requirements for all 6 substances, including the requirement that lead not exceed 0.1% by weight in homogeneous materials. Where designed to be soldered at high temperatures, TI Pb-Free products are suitable for use in specified lead-free processes.

**Pb-Free (RoHS Exempt):** This component has a RoHS exemption for either 1) lead-based flip-chip solder bumps used between the die and package, or 2) lead-based die adhesive used between the die and leadframe. The component is otherwise considered Pb-Free (RoHS compatible) as defined above.

---

**Green (RoHS & no Sb/Br):** TI defines "Green" to mean Pb-Free (RoHS compatible), and free of Bromine (Br) and Antimony (Sb) based flame retardants (Br or Sb do not exceed 0.1% by weight in homogeneous material)

<sup>(3)</sup> MSL, Peak Temp. -- The Moisture Sensitivity Level rating according to the JEDEC industry standard classifications, and peak solder temperature.

**Important Information and Disclaimer:** The information provided on this page represents TI's knowledge and belief as of the date that it is provided. TI bases its knowledge and belief on information provided by third parties, and makes no representation or warranty as to the accuracy of such information. Efforts are underway to better integrate information from third parties. TI has taken and continues to take reasonable steps to provide representative and accurate information but may not have conducted destructive testing or chemical analysis on incoming materials and chemicals. TI and TI suppliers consider certain information to be proprietary, and thus CAS numbers and other limited information may not be available for release.

In no event shall TI's liability arising out of such information exceed the total purchase price of the TI part(s) at issue in this document sold by TI to Customer on an annual basis.

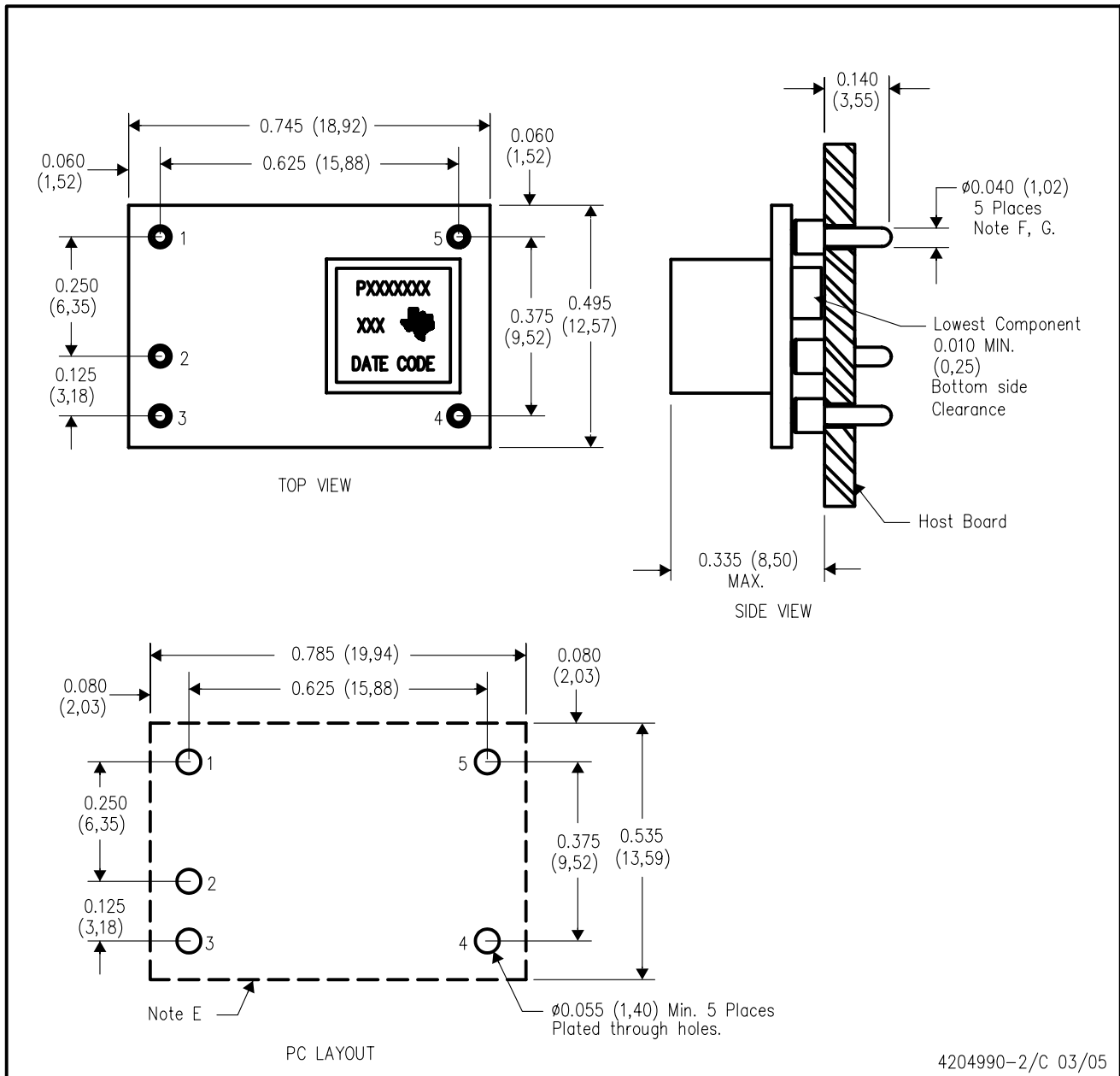

4204990-2/C 03/05

- NOTES:
- A. All linear dimensions are in inches (mm).
  - B. This drawing is subject to change without notice.
  - C. 2 place decimals are  $\pm 0.030$  ( $\pm 0,76$ mm).
  - D. 3 place decimals are  $\pm 0.010$  ( $\pm 0,25$ mm).
  - E. Recommended keep out area for user components.
  - F. Pins are 0.040" (1,02) diameter with 0.070" (1,78) diameter standoff shoulder.
  - G. All pins: Material - Copper Alloy  
Finish - Tin (100%) over Nickel plate



EUT (R-PDSS-B5)

DOUBLE SIDED MODULE

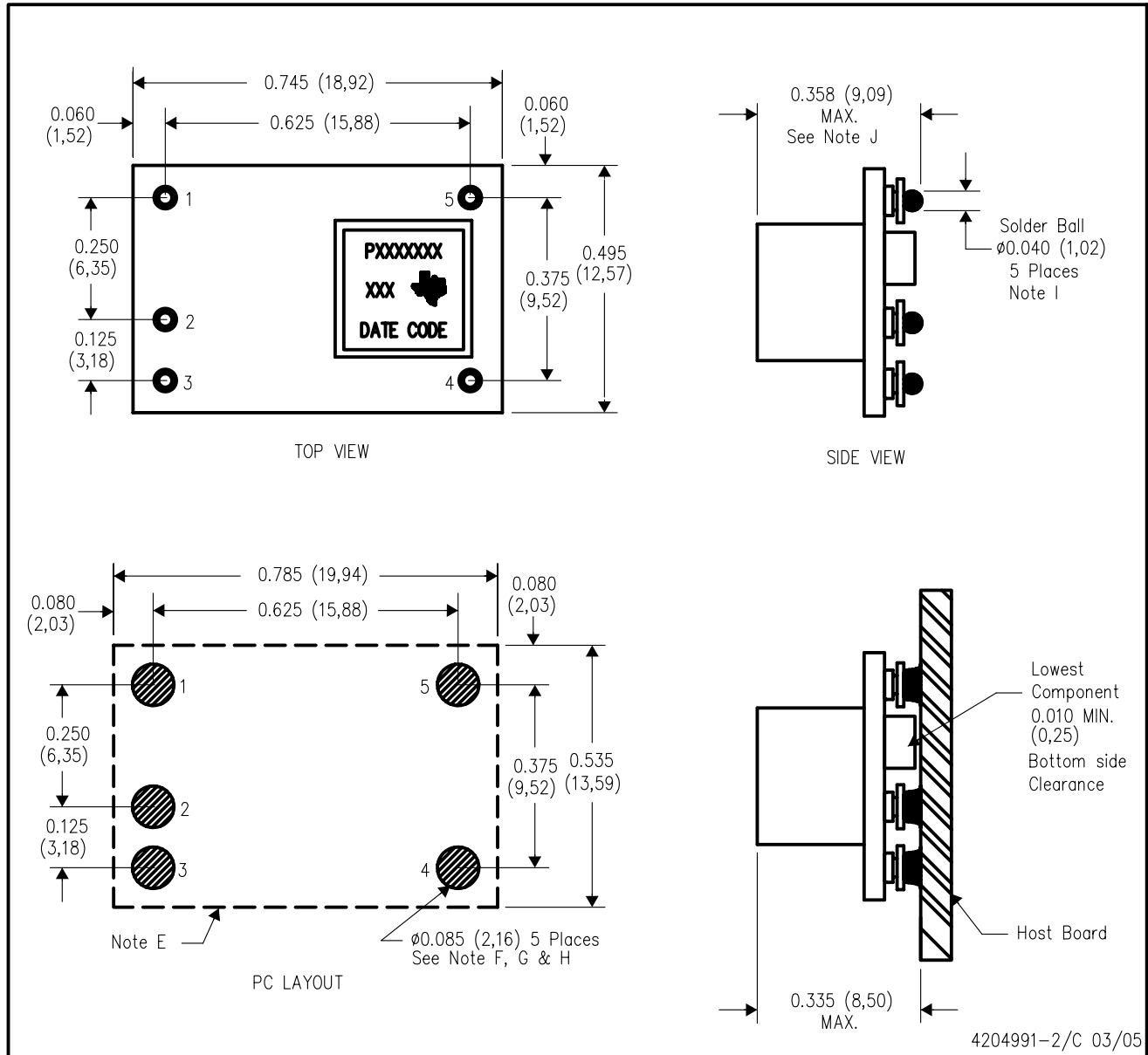

4204991-2/C 03/05

- NOTES:
- A. All linear dimensions are in inches (mm).
  - B. This drawing is subject to change without notice.
  - C. 2 place decimals are  $\pm 0.030$  ( $\pm 0,76$ mm).
  - D. 3 place decimals are  $\pm 0.010$  ( $\pm 0,25$ mm).
  - E. Recommended keep out area for user components.
  - F. Power pin connection should utilize two or more vias to the interior power plane of 0.025 (0,63) I.D. per input, ground and output pin (or the electrical equivalent).

- G. Paste screen opening: 0.080 (2,03) to 0.085 (2,16). Paste screen thickness: 0.006 (0,15).
- H. Pad type: Solder mask defined.
- I. All pins: Material - Copper Alloy  
Finish - Tin (100%) over Nickel plate  
Solder Ball - See product data sheet.
- J. Dimension prior to reflow solder.

## IMPORTANT NOTICE

Texas Instruments Incorporated and its subsidiaries (TI) reserve the right to make corrections, modifications, enhancements, improvements, and other changes to its products and services at any time and to discontinue any product or service without notice. Customers should obtain the latest relevant information before placing orders and should verify that such information is current and complete. All products are sold subject to TI's terms and conditions of sale supplied at the time of order acknowledgment.

TI warrants performance of its hardware products to the specifications applicable at the time of sale in accordance with TI's standard warranty. Testing and other quality control techniques are used to the extent TI deems necessary to support this warranty. Except where mandated by government requirements, testing of all parameters of each product is not necessarily performed.

TI assumes no liability for applications assistance or customer product design. Customers are responsible for their products and applications using TI components. To minimize the risks associated with customer products and applications, customers should provide adequate design and operating safeguards.

TI does not warrant or represent that any license, either express or implied, is granted under any TI patent right, copyright, mask work right, or other TI intellectual property right relating to any combination, machine, or process in which TI products or services are used. Information published by TI regarding third-party products or services does not constitute a license from TI to use such products or services or a warranty or endorsement thereof. Use of such information may require a license from a third party under the patents or other intellectual property of the third party, or a license from TI under the patents or other intellectual property of TI.

Reproduction of TI information in TI data books or data sheets is permissible only if reproduction is without alteration and is accompanied by all associated warranties, conditions, limitations, and notices. Reproduction of this information with alteration is an unfair and deceptive business practice. TI is not responsible or liable for such altered documentation. Information of third parties may be subject to additional restrictions.

Resale of TI products or services with statements different from or beyond the parameters stated by TI for that product or service voids all express and any implied warranties for the associated TI product or service and is an unfair and deceptive business practice. TI is not responsible or liable for any such statements.

TI products are not authorized for use in safety-critical applications (such as life support) where a failure of the TI product would reasonably be expected to cause severe personal injury or death, unless officers of the parties have executed an agreement specifically governing such use. Buyers represent that they have all necessary expertise in the safety and regulatory ramifications of their applications, and acknowledge and agree that they are solely responsible for all legal, regulatory and safety-related requirements concerning their products and any use of TI products in such safety-critical applications, notwithstanding any applications-related information or support that may be provided by TI. Further, Buyers must fully indemnify TI and its representatives against any damages arising out of the use of TI products in such safety-critical applications.

TI products are neither designed nor intended for use in military/aerospace applications or environments unless the TI products are specifically designated by TI as military-grade or "enhanced plastic." Only products designated by TI as military-grade meet military specifications. Buyers acknowledge and agree that any such use of TI products which TI has not designated as military-grade is solely at the Buyer's risk, and that they are solely responsible for compliance with all legal and regulatory requirements in connection with such use.

TI products are neither designed nor intended for use in automotive applications or environments unless the specific TI products are designated by TI as compliant with ISO/TS 16949 requirements. Buyers acknowledge and agree that, if they use any non-designated products in automotive applications, TI will not be responsible for any failure to meet such requirements.

Following are URLs where you can obtain information on other Texas Instruments products and application solutions:

<b>Products</b>		<b>Applications</b>	
Amplifiers	<a href="http://amplifier.ti.com">amplifier.ti.com</a>	Audio	<a href="http://www.ti.com/audio">www.ti.com/audio</a>
Data Converters	<a href="http://dataconverter.ti.com">dataconverter.ti.com</a>	Automotive	<a href="http://www.ti.com/automotive">www.ti.com/automotive</a>
DLP® Products	<a href="http://www.dlp.com">www.dlp.com</a>	Communications and Telecom	<a href="http://www.ti.com/communications">www.ti.com/communications</a>
DSP	<a href="http://dsp.ti.com">dsp.ti.com</a>	Computers and Peripherals	<a href="http://www.ti.com/computers">www.ti.com/computers</a>
Clocks and Timers	<a href="http://www.ti.com/clocks">www.ti.com/clocks</a>	Consumer Electronics	<a href="http://www.ti.com/consumer-apps">www.ti.com/consumer-apps</a>
Interface	<a href="http://interface.ti.com">interface.ti.com</a>	Energy	<a href="http://www.ti.com/energy">www.ti.com/energy</a>
Logic	<a href="http://logic.ti.com">logic.ti.com</a>	Industrial	<a href="http://www.ti.com/industrial">www.ti.com/industrial</a>
Power Mgmt	<a href="http://power.ti.com">power.ti.com</a>	Medical	<a href="http://www.ti.com/medical">www.ti.com/medical</a>
Microcontrollers	<a href="http://microcontroller.ti.com">microcontroller.ti.com</a>	Security	<a href="http://www.ti.com/security">www.ti.com/security</a>
RFID	<a href="http://www.ti-rfid.com">www.ti-rfid.com</a>	Space, Avionics & Defense	<a href="http://www.ti.com/space-avionics-defense">www.ti.com/space-avionics-defense</a>
RF/IF and ZigBee® Solutions	<a href="http://www.ti.com/lprf">www.ti.com/lprf</a>	Video and Imaging	<a href="http://www.ti.com/video">www.ti.com/video</a>
		Wireless	<a href="http://www.ti.com/wireless-apps">www.ti.com/wireless-apps</a>

Mailing Address: Texas Instruments, Post Office Box 655303, Dallas, Texas 75265  
Copyright © 2010, Texas Instruments Incorporated

[www.BDTIC.com/TI](http://www.BDTIC.com/TI)