

- Free-Running CLKA and CLKB Can Be Asynchronous or Coincident
- Two Independent 64 × 36 Clocked FIFOs Buffering Data in Opposite Directions
- Mailbox-Bypass Register for Each FIFO
- Programmable Almost-Full and Almost-Empty Flags
- Microprocessor Interface Control Logic
- $\overline{\text{EFA}}$ ,  $\overline{\text{FFA}}$ ,  $\overline{\text{AEA}}$ , and  $\overline{\text{AFA}}$  Flags Synchronized by CLKA
- $\overline{\text{EFB}}$ ,  $\overline{\text{FFB}}$ ,  $\overline{\text{AEB}}$ , and  $\overline{\text{AFB}}$  Flags Synchronized by CLKB
- Passive Parity Checking on Each Port
- Parity Generation Can Be Selected for Each Port
- Low-Power Advanced BiCMOS Technology
- Supports Clock Frequencies up to 67 MHz
- Fast Access Times of 10 ns
- Package Options Include 120-Pin Thin Quad Flat (PCB) and 132-Pin Plastic Quad Flat (PQ) Packages

## description

The SN74ABT3612 is a high-speed, low-power BiCMOS bidirectional clocked FIFO memory. It supports clock frequencies up to 67 MHz and has read access times as fast as 10 ns. Two independent 64 × 36 dual-port SRAM FIFOs in this device buffer data in opposite directions. Each FIFO has flags to indicate empty and full conditions and two programmable flags (almost-full and almost-empty) to indicate when a selected number of words is stored in memory. Communication between each port can bypass the FIFOs via two 36-bit mailbox registers. Each mailbox register has a flag to signal when new mail has been stored. Parity is checked passively on each port and can be ignored if not desired. Parity generation can be selected for data read from each port. Two or more devices can be used in parallel to create wider datapaths.

The SN74ABT3612 is a clocked FIFO, which means each port employs a synchronous interface. All data transfers through a port are gated to the low-to-high transition of a port clock by enable signals. The clocks for each port are independent of one another and can be asynchronous or coincident. The enables for each port are arranged to provide a simple bidirectional interface between microprocessors and/or buses with synchronous control.

The full flag ( $\overline{\text{FFA}}$ ,  $\overline{\text{FFB}}$ ) and almost-full ( $\overline{\text{AFA}}$ ,  $\overline{\text{AFB}}$ ) flag of a FIFO are two-stage synchronized to the port clock that writes data to its array. The empty flag ( $\overline{\text{EFA}}$ ,  $\overline{\text{EFB}}$ ) and almost-empty ( $\overline{\text{AEA}}$ ,  $\overline{\text{AEB}}$ ) flag of a FIFO are two-stage synchronized to the port clock that reads data from its array.

The SN74ABT3612 is characterized for operation from 0°C to 70°C.

For more information on this device family, see the following application reports:

- *FIFO Mailbox-Bypass Registers: Using Bypass Registers to Initialize DMA Control (literature number SCAA007)*
- *Parity-Generate and Parity-Check Features for High-Bandwidth-Computing FIFO Applications (literature number SCAA015)*
- *Metastability Performance of Clocked FIFOs (literature number SCZA004)*



Please be aware that an important notice concerning availability, standard warranty, and use in critical applications of Texas Instruments semiconductor products and disclaimers thereto appears at the end of this data sheet.

PRODUCTION DATA information is current as of publication date. Products conform to specifications per the terms of Texas Instruments standard warranty. Production processing does not necessarily include testing of all parameters.



TEXAS  
INSTRUMENTS

[www.BDITIC.com/TI](http://www.BDITIC.com/TI)

POST OFFICE BOX 65543 • DALLAS, TEXAS 75266

Copyright © 1998, Texas Instruments Incorporated

SN74ABT3612

64 × 36 × 2

CLOCKED BIDIRECTIONAL FIRST-IN, FIRST-OUT MEMORY

SCBS129G – JULY 1992 – REVISED APRIL 1998

PCB PACKAGE  
(TOP VIEW)

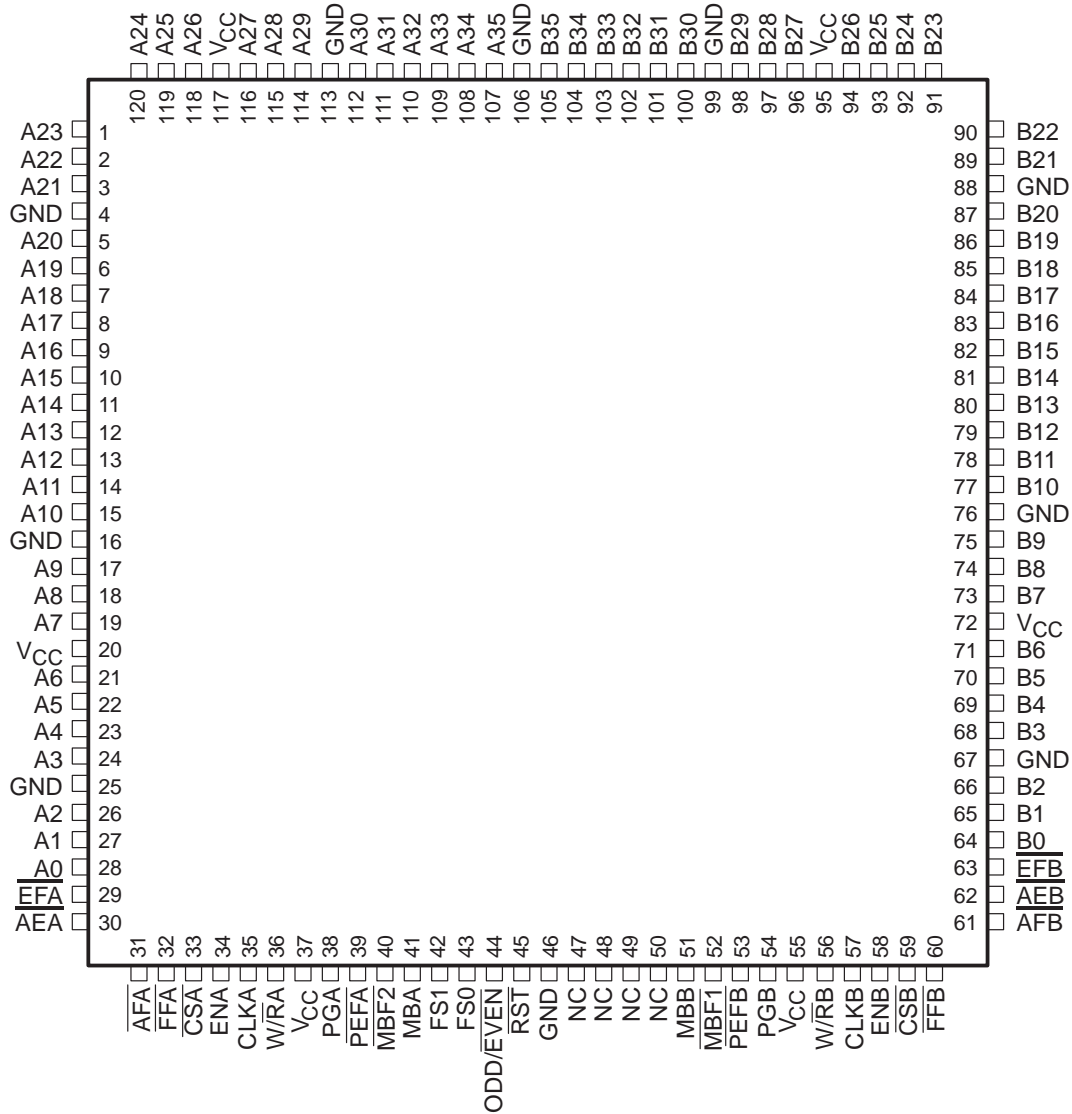

NC – No internal connection

CLOCKED BIDIRECTIONAL FIRST-IN, FIRST-OUT MEMORY

SCBS129G – JULY 1992 – REVISED APRIL 1998

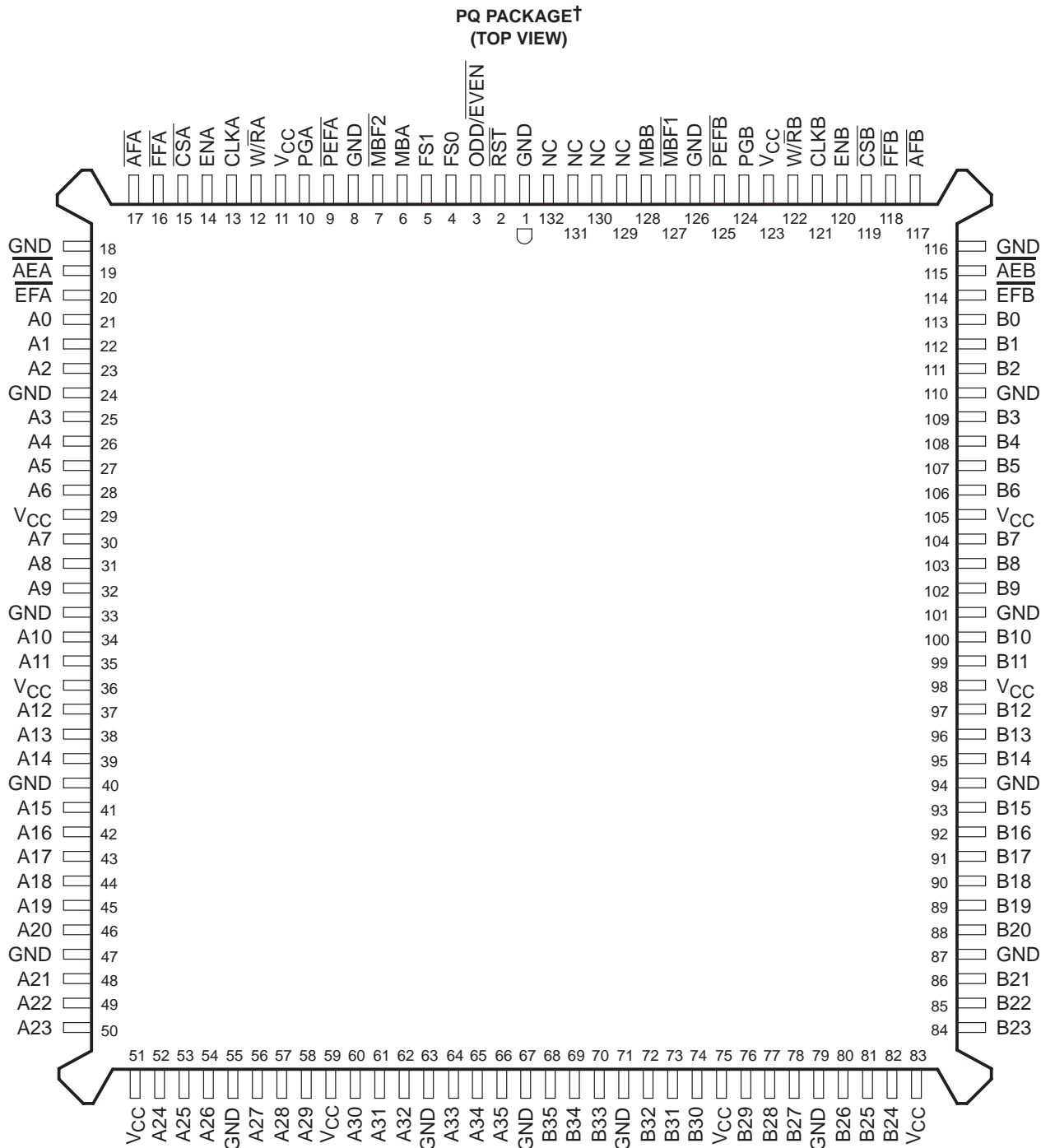

NC – No internal connection  
 † Uses Yamaichi socket IC51-1324-828

SN74ABT3612

64 × 36 × 2

CLOCKED BIDIRECTIONAL FIRST-IN, FIRST-OUT MEMORY

SCBS129G – JULY 1992 – REVISED APRIL 1998

functional block diagram

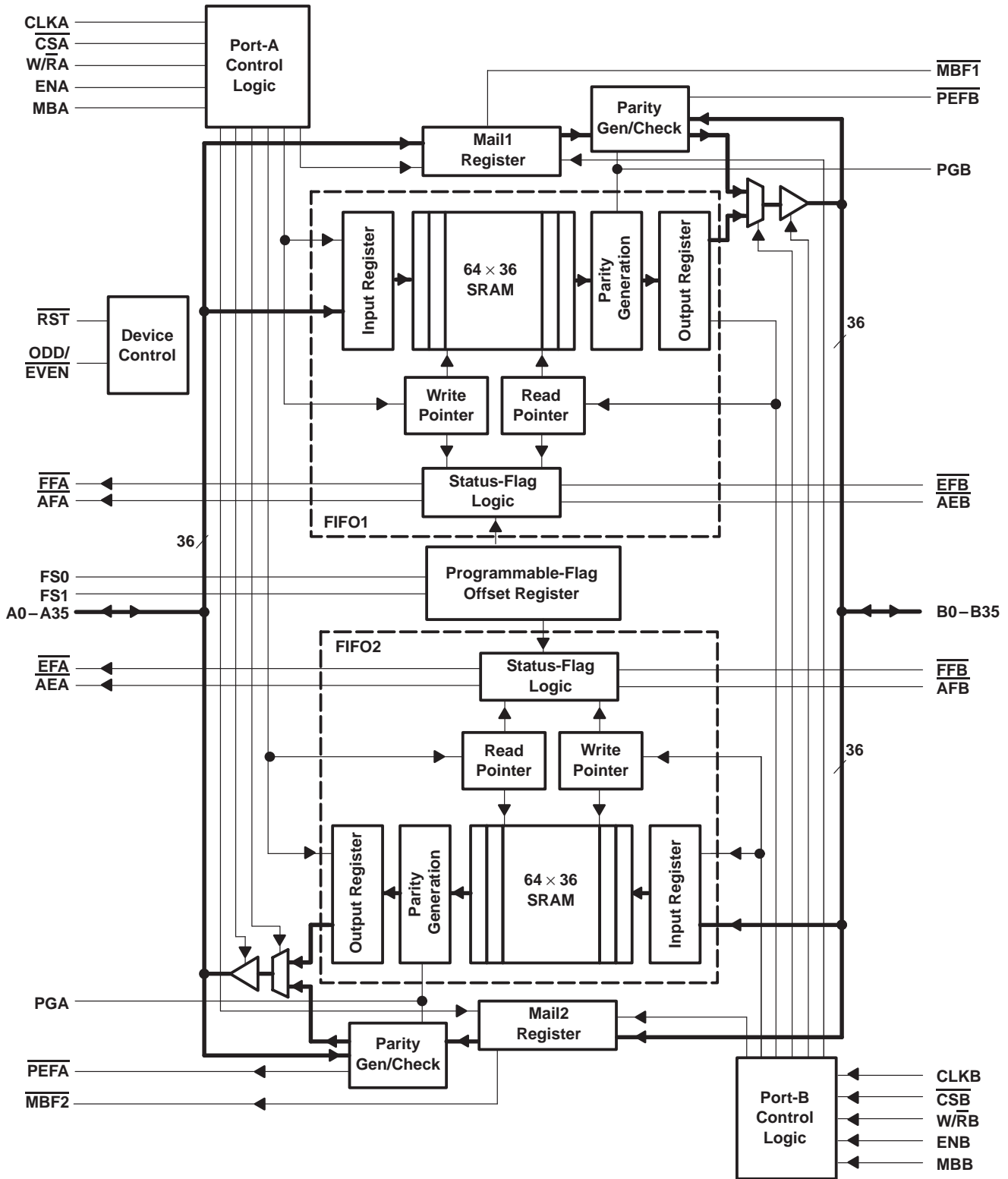

## CLOCKED BIDIRECTIONAL FIRST-IN, FIRST-OUT MEMORY

SCBS129G – JULY 1992 – REVISED APRIL 1998

## Terminal Functions

PIN NAME	I/O	DESCRIPTION
A0–A35	I/O	Port-A data. The 36-bit bidirectional data port for side A.
AEA	O (port A)	Port-A almost-empty flag. Programmable flag synchronized to CLKA. $\overline{AEA}$ is low when the number of words in FIFO2 is less than or equal to the value in offset register X.
AEB	O (port B)	Port-B almost-empty flag. Programmable flag synchronized to CLKB. $\overline{AEB}$ is low when the number of words in FIFO1 is less than or equal to the value in offset register X.
AFA	O (port A)	Port-A almost-full flag. Programmable flag synchronized to CLKA. $\overline{AFA}$ is low when the number of empty locations in FIFO1 is less than or equal to the value in offset register X.
AFB	O (port B)	Port-B almost-full flag. Programmable flag synchronized to CLKB. $\overline{AFB}$ is low when the number of empty locations in FIFO2 is less than or equal to the value in offset register X.
B0–B35	I/O	Port-B data. The 36-bit bidirectional data port for side B.
CLKA	I	Port-A clock. CLKA is a continuous clock that synchronizes all data transfers through port A and can be asynchronous or coincident to CLKB. $\overline{EFA}$ , $\overline{FFA}$ , $\overline{AFA}$ , and $\overline{AEA}$ are synchronized to the low-to-high transition of CLKA.
CLKB	I	Port-B clock. CLKB is a continuous clock that synchronizes all data transfers through port B and can be asynchronous or coincident to CLKA. $\overline{EFB}$ , $\overline{FFB}$ , $\overline{AFB}$ , and $\overline{AEB}$ are synchronized to the low-to-high transition of CLKB.
CSA	I	Port-A chip select. $\overline{CSA}$ must be low to enable a low-to-high transition of CLKA to read or write data on port A. The A0–A35 outputs are in the high-impedance state when CSA is high.
CSB	I	Port-B chip select. $\overline{CSB}$ must be low to enable a low-to-high transition of CLKB to read or write data on port B. The B0–B35 outputs are in the high-impedance state when CSB is high.
$\overline{EFA}$	O (port A)	Port-A empty flag. $\overline{EFA}$ is synchronized to the low-to-high transition of CLKA. When $\overline{EFA}$ is low, FIFO2 is empty and reads from its memory are disabled. Data can be read from FIFO2 to the output register when EFA is high. EFA is forced low when the device is reset and is set high by the second low-to-high transition of CLKA after data is loaded into empty FIFO2 memory.
$\overline{EFB}$	O (port B)	Port-B empty flag. $\overline{EFB}$ is synchronized to the low-to-high transition of CLKB. When $\overline{EFB}$ is low, FIFO1 is empty and reads from its memory are disabled. Data can be read from FIFO1 to the output register when EFB is high. EFB is forced low when the device is reset and is set high by the second low-to-high transition of CLKB after data is loaded into empty FIFO1 memory.
ENA	I	Port-A enable. ENA must be high to enable a low-to-high transition of CLKA to read or write data on port A.
ENB	I	Port-B enable. ENB must be high to enable a low-to-high transition of CLKB to read or write data on port B.
FFA	O (port A)	Port-A full flag. $\overline{FFA}$ is synchronized to the low-to-high transition of CLKA. When $\overline{FFA}$ is low, FIFO1 is full and writes to its memory are disabled. $\overline{FFA}$ is forced low when the device is reset and is set high by the second low-to-high transition of CLKA after reset.
FFB	O (port B)	Port-B full flag. $\overline{FFB}$ is synchronized to the low-to-high transition of CLKB. When $\overline{FFB}$ is low, FIFO2 is full and writes to its memory are disabled. $\overline{FFB}$ is forced low when the device is reset and is set high by the second low-to-high transition of CLKB after reset.
FS1, FS0	I	Flag-offset selects. The low-to-high transition of $\overline{RST}$ latches the values of FS0 and FS1, which selects one of four preset values for the almost-empty flag and almost-full flag offset.
MBA	I	Port-A mailbox select. A high level on MBA chooses a mailbox register for a port-A read or write operation. When the A0–A35 outputs are active, a high level on MBA selects data from the mail2 register for output and a low level selects FIFO2 output register data for output.
MBB	I	Port-B mailbox select. A high level on MBB chooses a mailbox register for a port-B read or write operation. When the B0–B35 outputs are active, a high level on MBB selects data from the mail1 register for output and a low level selects FIFO1 output register data for output.
MBF1	O	Mail1 register flag. $\overline{MBF1}$ is set low by the low-to-high transition of CLKA that writes data to the mail1 register. Writes to the mail1 register are inhibited while $\overline{MBF1}$ is low. $\overline{MBF1}$ is set high by a low-to-high transition of CLKB when a port-B read is selected and MBB is high. $\overline{MBF1}$ is set high when the device is reset.

Terminal Functions (Continued)

PIN NAME	I/O	DESCRIPTION
MBF2	O	Mail2 register flag. MBF2 is set low by the low-to-high transition of CLKB that writes data to the mail2 register. Writes to the mail2 register are inhibited while MBF2 is low. MBF2 is set high by a low-to-high transition of CLKA when a port-A read is selected and MBA is high. MBF2 is set high when the device is reset.
ODD/ EVEN	I	Odd/even parity select. Odd parity is checked on each port when ODD/ <u>EVEN</u> is high and even parity is checked when ODD/ <u>EVEN</u> is low. ODD/ <u>EVEN</u> also selects the type of parity generated for each port if parity generation is enabled for a read operation.
PEFA	O (port A)	Port-A parity error flag. When any byte applied to A0–A35 fails parity, <u>PEFA</u> is low. Bytes are organized as A0–A8, A9–A17, A18–A26, and A27–A35, with the most-significant bit of each byte serving as the parity bit. The type of parity checked is determined by the state of ODD/ <u>EVEN</u> . The parity trees used to check the A0–A35 inputs are shared by the mail2 register to generate parity if parity generation is selected by PGA. Therefore, if a mail2 read with parity generation is set up by having <u>W/RA</u> low, MBA high, and PGA high, <u>PEFA</u> is forced high regardless of the state of the A0–A35 inputs.
PEFB	O (port B)	Port-B parity error flag. When any byte applied to terminals B0–B35 fails parity, <u>PEFB</u> is low. Bytes are organized as B0–B8, B9–B17, B18–B26, and B27–B35, with the most-significant bit of each byte serving as the parity bit. The type of parity checked is determined by the state of ODD/ <u>EVEN</u> . The parity trees used to check the B0–B35 inputs are shared by the mail1 register to generate parity if parity generation is selected by PGB. Therefore, if a mail1 read with parity generation is set up by having <u>W/RB</u> low, MBB high, and PGB high, <u>PEFB</u> is forced high regardless of the state of the B0–B35 inputs.
PGA	I	Port-A parity generation. Parity is generated for data reads from port A when PGA is high. The type of parity generated is selected by the state of ODD/ <u>EVEN</u> . Bytes are organized as A0–A8, A9–A17, A18–A26, and A27–A35. The generated parity bits are output in the most-significant bit of each byte.
PGB	I	Port-B parity generation. Parity is generated for data reads from port B when PGB is high. The type of parity generated is selected by the state of ODD/ <u>EVEN</u> . Bytes are organized as B0–B8, B9–B17, B18–B26, and B27–B35. The generated parity bits are output in the most-significant bit of each byte.
RST	I	Reset. To reset the device, four low-to-high transitions of <u>CLKA</u> and four low-to-high transitions of <u>CLKB</u> must occur while RST is low. This sets AFA, AFB, MBF1, and MBF2 high and EFA, EFB, AEA, AEB, FFA, and FFB low. The low-to-high transition of <u>RST</u> latches the status of FS1 and FS0 to select almost-full flag and almost-empty flag offset.
<u>W/RA</u>	I	Port-A write/read select. <u>W/RA</u> high selects a write operation and a low selects a read operation on port A for a low-to-high transition of CLKA. The A0–A35 outputs are in the high-impedance state when <u>W/RA</u> is high.
<u>W/RB</u>	I	Port-B write/read select. <u>W/RB</u> high selects a write operation and a low selects a read operation on port B for a low-to-high transition of CLKB. The B0–B35 outputs are in the high-impedance state when <u>W/RB</u> is high.

detailed description

reset

The SN74ABT3612 is reset by taking the reset (RST) input low for at least four port-A clock (CLKA) and four port-B clock (CLKB) low-to-high transitions. RST can switch asynchronously to the clocks. A device reset initializes the internal read and write pointers of each FIFO and forces the full flags (FFA, FFB) low, the empty flags (EFA, EFB) low, the almost-empty flags (AEA, AEB) low, and the almost-full flags (AFA, AFB) high. A reset also forces the mailbox flags (MBF1, MBF2) high. After a reset, FFA is set high after two low-to-high transitions of CLKA and FFB is set high after two low-to-high transitions of CLKB. The device must be reset after power up before data is written to its memory.

A low-to-high transition on RST loads the almost-full and almost-empty offset register (X) with the value selected by the flag-select (FS0, FS1) inputs. The values that can be loaded into the register are shown in Table 1.

reset (continued)

Table 1. Flag Programming

FS1	FS0	RST	ALMOST-FULL AND ALMOST-EMPTY FLAG OFFSET REGISTER (X)
H	H	↑	16
H	L	↑	12
L	H	↑	8
L	L	↑	4

## FIFO write/read operation

The state of the port-A data (A0–A35) outputs is controlled by the port-A chip select ( $\overline{CSA}$ ) and the port-A write/read select ( $W/\overline{RA}$ ). The A0–A35 outputs are in the high-impedance state when either  $\overline{CSA}$  or  $W/\overline{RA}$  is high. The A0–A35 outputs are active when both  $\overline{CSA}$  and  $W/\overline{RA}$  are low. Data is loaded into FIFO1 from the A0–A35 inputs on a low-to-high transition of CLKA when  $\overline{CSA}$  is low,  $W/\overline{RA}$  is high, ENA is high, MBA is low, and  $\overline{FFA}$  is high. Data is read from FIFO2 to the A0–A35 outputs by a low-to-high transition of CLKA when  $\overline{CSA}$  is low,  $W/\overline{RA}$  is low, ENA is high, MBA is low, and  $\overline{EFA}$  is high (see Table 2).

Table 2. Port-A Enable Function Table

CSA	$W/\overline{RA}$	ENA	MBA	CLKA	A0–A35 OUTPUTS	PORT FUNCTION
H	X	X	X	X	In high-impedance state	None
L	H	L	X	X	In high-impedance state	None
L	H	H	L	↑	In high-impedance state	FIFO1 write
L	H	H	H	↑	In high-impedance state	Mail1 write
L	L	L	L	X	Active, FIFO2 output register	None
L	L	H	L	↑	Active, FIFO2 output register	FIFO2 read
L	L	L	H	X	Active, mail2 register	None
L	L	H	H	↑	Active, mail2 register	Mail2 read (set $\overline{MBF2}$ high)

The port-B control signals are identical to those of port A. The state of the port-B data (B0–B35) outputs is controlled by the port-B chip select ( $\overline{CSB}$ ) and the port-B write/read select ( $W/\overline{RB}$ ). The B0–B35 outputs are in the high-impedance state when either  $\overline{CSB}$  or  $W/\overline{RB}$  is high. The B0–B35 outputs are active when both  $\overline{CSB}$  and  $W/\overline{RB}$  are low.

Data is loaded into FIFO2 from the B0–B35 inputs on a low-to-high transition of CLKB when  $\overline{CSB}$  is low,  $W/\overline{RB}$  is high, ENB is high, MBB is low, and  $\overline{FFB}$  is high. Data is read from FIFO1 to the B0–B35 outputs by a low-to-high transition of CLKB when  $\overline{CSB}$  is low,  $W/\overline{RB}$  is low, ENB is high, MBB is high, and  $\overline{EFB}$  is high (see Table 3).

The setup- and hold-time constraints to the port clocks for the port-chip selects ( $\overline{CSA}$ ,  $\overline{CSB}$ ) and write/read selects ( $W/\overline{RA}$ ,  $W/\overline{RB}$ ) are only for enabling write and read operations and are not related to high-impedance control of the data outputs. If a port enable is low during a clock cycle, the port-chip select and write/read select can change states during the setup- and hold-time window of the cycle.

FIFO write/read operation (continued)

Table 3. Port-B Enable Function Table

CSB	W/RB	ENB	MBB	CLKB	B0–B35 OUTPUTS	PORT FUNCTION
H	X	X	X	X	In high-impedance state	None
L	H	L	X	X	In high-impedance state	None
L	H	H	L	↑	In high-impedance state	FIFO2 write
L	H	H	H	↑	In high-impedance state	Mail2 write
L	L	L	L	X	Active, FIFO1 output register	None
L	L	H	L	↑	Active, FIFO1 output register	FIFO1 read
L	L	L	H	X	Active, mail1 register	None
L	L	H	H	↑	Active, mail1 register	Mail1 read (set $\overline{\text{MBF1}}$ high)

synchronized FIFO flags

Each FIFO flag is synchronized to its port clock through two flip-flop stages. This is done to improve flag reliability by reducing the probability of metastable events on the output when  $\text{CLKA}$  and  $\text{CLKB}$  operate asynchronously to one another.  $\overline{\text{EFA}}$ ,  $\overline{\text{AEA}}$ ,  $\overline{\text{FFA}}$ , and  $\overline{\text{AFA}}$  are synchronized to  $\text{CLKA}$ .  $\overline{\text{EFB}}$ ,  $\overline{\text{AEB}}$ ,  $\overline{\text{FFB}}$ , and  $\overline{\text{AFB}}$  are synchronized to  $\text{CLKB}$ . Tables 4 and 5 show the relationship of each port flag to FIFO1 and FIFO2.

Table 4. FIFO1 Flag Operation

NUMBER OF WORDS IN FIFO1†	SYNCHRONIZED TO CLKB		SYNCHRONIZED TO CLKA	
	EFB	AEB	AFA	FFA
0	L	L	H	H
1 to X	H	L	H	H
(X + 1) to [64 – (X + 1)]	H	H	H	H
(64 – X) to 63	H	H	L	H
64	H	H	L	L

† X is the value in the almost-empty flag and almost-full flag offset register.

Table 5. FIFO2 Flag Operation

NUMBER OF WORDS IN FIFO2†	SYNCHRONIZED TO CLKA		SYNCHRONIZED TO CLKB	
	EFA	AEA	AFB	FFB
0	L	L	H	H
1 to X	H	L	H	H
(X + 1) to [64 – (X + 1)]	H	H	H	H
(64 – X) to 63	H	H	L	H
64	H	H	L	L

† X is the value in the almost-empty flag and almost-full flag offset register.



**empty flags ( $\overline{EFA}$ ,  $\overline{EFB}$ )**

The empty flag of a FIFO is synchronized to the port clock that reads data from its array. When the empty flag is high, new data can be read to the FIFO output register. When the empty flag is low, the FIFO is empty and attempted FIFO reads are ignored.

The read pointer of a FIFO is incremented each time a new word is clocked to the output register. A word written to a FIFO can be read to the FIFO output register in a minimum of three cycles of the empty flag synchronizing clock; therefore, an empty flag is low if a word in memory is the next data to be sent to the FIFO output register and two cycles of the port clock that reads data from the FIFO have not elapsed since the time the word was written. The empty flag of the FIFO is set high by the second low-to-high transition of the synchronizing clock and the new data word can be read to the FIFO output register in the following cycle.

A low-to-high transition on an empty flag synchronizing clock begins the first synchronization cycle of a write if the clock transition occurs at time  $t_{sk1}$ , or greater, after the write. Otherwise, the subsequent clock cycle can be the first synchronization cycle (see Figures 6 and 7).

**full flags ( $\overline{FFA}$ ,  $\overline{FFB}$ )**

The full flag of a FIFO is synchronized to the port clock that writes data to its array. When the full flag is high, a memory location is free in the SRAM to receive new data. No memory locations are free when the full flag is low and attempted writes to the FIFO are ignored.

Each time a word is written to a FIFO, the write pointer is incremented. From the time a word is read from a FIFO, the previous memory location is ready to be written in a minimum of three cycles of the full flag synchronizing clock; therefore, a full flag is low if less than two cycles of the full-flag synchronizing clock have elapsed since the next memory write location has been read. The second low-to-high transition on the full-flag synchronizing clock after the read sets the full flag high and data can be written in the following clock cycle.

A low-to-high transition on a full-flag synchronizing clock begins the first synchronization cycle of a read if the clock transition occurs at time  $t_{sk1}$ , or greater, after the read. Otherwise, the subsequent clock cycle can be the first synchronization cycle (see Figures 8 and 9).

**almost-empty flags ( $\overline{AEA}$ ,  $\overline{AEB}$ )**

The almost-empty flag of a FIFO is synchronized to the port clock that reads data from its array. The almost-empty state is defined by the value of the almost-full and almost-empty offset register (X). This register is loaded with one of four preset values during a device reset (see *reset*). An almost-empty flag is low when the FIFO contains X or less words in memory and is high when the FIFO contains (X + 1) or more words.

Two low-to-high transitions of the almost-empty flag synchronizing clock are required after a FIFO write for the almost-empty flag to reflect the new level of fill; therefore, the almost-empty flag of a FIFO containing (X + 1) or more words remains low if two cycles of the synchronizing clock have not elapsed since the write that filled the memory to the (X + 1) level. An almost-empty flag is set high by the second low-to-high transition of the synchronizing clock after the FIFO write that fills memory to the (X + 1) level. A low-to-high transition of an almost-empty flag synchronizing clock begins the first synchronization cycle if it occurs at time  $t_{sk2}$ , or greater, after the write that fills the FIFO to (X + 1) words. Otherwise, the subsequent synchronizing clock cycle can be the first synchronization cycle (see Figures 11 and 12).

**almost-full flags ( $\overline{AFA}$ ,  $\overline{AFB}$ )**

The almost-full flag of a FIFO is synchronized to the port clock that writes data to its array. The almost-full state is defined by the value of the almost-full and almost-empty offset register (X). This register is loaded with one of four preset values during a device reset (see *reset*). An almost-full flag is low when the FIFO contains (64 – X) or more words in memory and is high when the FIFO contains [64 – (X + 1)] or less words.

Two low-to-high transitions of the almost-full flag synchronizing clock are required after a FIFO read for the almost-full flag to reflect the new level of fill; therefore, the almost-full flag of a FIFO containing [64 – (X + 1)] or less words remains low if two cycles of the synchronizing clock have not elapsed since the read that reduced the number of words in memory to [64 – (X + 1)]. An almost-full flag is set high by the second low-to-high

**almost-full flags ( $\overline{AFA}$ ,  $\overline{AFB}$ ) (continued)**

transition of the synchronizing clock after the FIFO read that reduces the number of words in memory to  $[64 - (X + 1)]$ . A low-to-high transition of an almost-full flag synchronizing clock begins the first synchronization cycle if it occurs at time  $t_{sk2}$ , or greater, after the read that reduces the number of words in memory to  $[64 - (X + 1)]$ . Otherwise, the subsequent synchronizing clock cycle can be the first synchronization cycle (see Figures 13 and 14).

**mailbox registers**

Each FIFO has a 36-bit bypass register to pass command and control information between port A and port B without putting it in queue. The mailbox-select (MBA, MBB) inputs choose between a mail register and a FIFO for a port-data-transfer operation. A low-to-high transition on CLKA writes A0–A35 data to the mail1 register when a port-A write is selected by  $\overline{CSA}$ ,  $W/\overline{RA}$ , and ENA and MBA is high. A low-to-high transition on CLKB writes B0–B35 data to the mail2 register when a port-B write is selected by  $\overline{CSB}$ ,  $W/\overline{RB}$ , and ENB and MBB is high. Writing data to a mail register sets the corresponding flag ( $\overline{MBF1}$  or  $\overline{MBF2}$ ) low. Attempted writes to a mail register are ignored while the mail flag is low.

When a port's data outputs are active, the data on the bus comes from the FIFO output register when the port mailbox-select input (MBA, MBB) is low and from the mail register when MBA/MBB is high. The mail1 register flag ( $\overline{MBF1}$ ) is set high by a low-to-high transition on CLKB when a port-B read is selected by  $\overline{CSB}$ ,  $W/\overline{RB}$ , and ENB and MBB is high. The mail2 register flag ( $\overline{MBF2}$ ) is set high by a low-to-high transition on CLKA when a port-A read is selected by  $\overline{CSA}$ ,  $W/\overline{RA}$ , and ENA and MBA is high. The data in a mail register remains intact after it is read and changes only when new data is written to the register.

**parity checking**

The port-A inputs (A0–A35) and port-B inputs (B0–B35) each have four parity trees to check the parity of incoming (or outgoing) data. A parity failure on one or more bytes of the input bus is reported by a low level on the port-parity-error flag ( $\overline{PEFA}$ ,  $\overline{PEFB}$ ). Odd- or even-parity checking can be selected and the parity-error flags can be ignored if this feature is not desired.

Parity status is checked on each input bus according to the level of the odd/even parity ( $ODD/\overline{EVEN}$ ) select input. A parity error on one or more bytes of a port is reported by a low level on the corresponding  $\overline{PEFA}$ ,  $\overline{PEFB}$ . Port-A bytes are arranged as A0–A8, A9–A17, A18–A26, and A27–A35, with the most-significant bit of each byte used as the parity bit. Port-B bytes are arranged as B0–B8, B9–B17, B18–B26, and B27–B35, with the most-significant bit of each byte used as the parity bit. When odd/even parity is selected,  $\overline{PEFA}$ ,  $\overline{PEFB}$  is low if any byte on the port has an odd/even number of low levels applied to the bits.

The four parity trees used to check the A0–A35 inputs are shared by the mail2 register when parity generation is selected for port-A reads (PGA = high). When a port-A read from the mail2 register with parity generation is selected with  $W/\overline{RA}$  low,  $\overline{CSA}$  low, ENA high, MBA high, and PGA high,  $\overline{PEFA}$  is held high, regardless of the levels applied to the A0–A35 inputs. Likewise, the parity trees used to check the B0–B35 inputs are shared by the mail1 register when parity generation is selected for port-B reads (PGB = high). When a port-B read from the mail1 register with parity generation is selected with  $W/\overline{RB}$  low,  $\overline{CSB}$  low, ENB high, MBB high, and PGB high,  $\overline{PEFB}$  is held high, regardless of the levels applied to the B0–B35 inputs.

**parity generation**

A high level on the port-A parity-generate select (PGA) or port-B parity-generate select (PGB) enables the SN74ABT3612 to generate parity bits for port reads from a FIFO or mailbox register. Port-A bytes are arranged as A0–A8, A9–A17, A18–A26, and A27–A35, with the most-significant bit of each byte used as the parity bit. Port-B bytes are arranged as B0–B8, B9–B17, B18–B26, and B27–B35, with the most-significant bit of each byte used as the parity bit. A write to a FIFO or mail register stores the levels applied to all 36 inputs, regardless of the state of the parity-generate select (PGA, PGB) inputs. When data is read from a port with parity generation selected, the lower eight bits of each byte are used to generate a parity bit according to the level on the  $ODD/\overline{EVEN}$  select. The generated parity bits are substituted for the levels originally written to the most-significant bits of each byte as the word is read to the data outputs.



## parity generation (continued)

Parity bits for FIFO data are generated after the data is read from SRAM and before the data is written to the output register. Therefore, the port-A parity generate select (PGA) and odd/even parity select (ODD/EVEN) have setup- and hold-time constraints to the port-A clock (CLKA) and the port-B parity generate select (PGB) and ODD/EVEN have setup- and hold-time constraints to the port-B clock (CLKB). These timing constraints apply only for a rising clock edge used to read a new word to the FIFO output register.

The circuit used to generate parity for the mail1 data is shared by the port-B bus (B0–B35) to check parity and the circuit used to generate parity for the mail2 data is shared by the port-A bus (A0–A35) to check parity. The shared parity trees of a port are used to generate parity bits for the data in a mail register when  $\overline{W\overline{R}A}$ ,  $\overline{W\overline{R}B}$  is low;  $\overline{MBA}$ ,  $\overline{MBB}$  is high;  $\overline{CSA}$ ,  $\overline{CSB}$  is low;  $\overline{ENA}$ ,  $\overline{ENB}$  is high; and  $\overline{PGA}$ ,  $\overline{PGB}$  is high. Generating parity for mail-register data does not change the contents of the register.

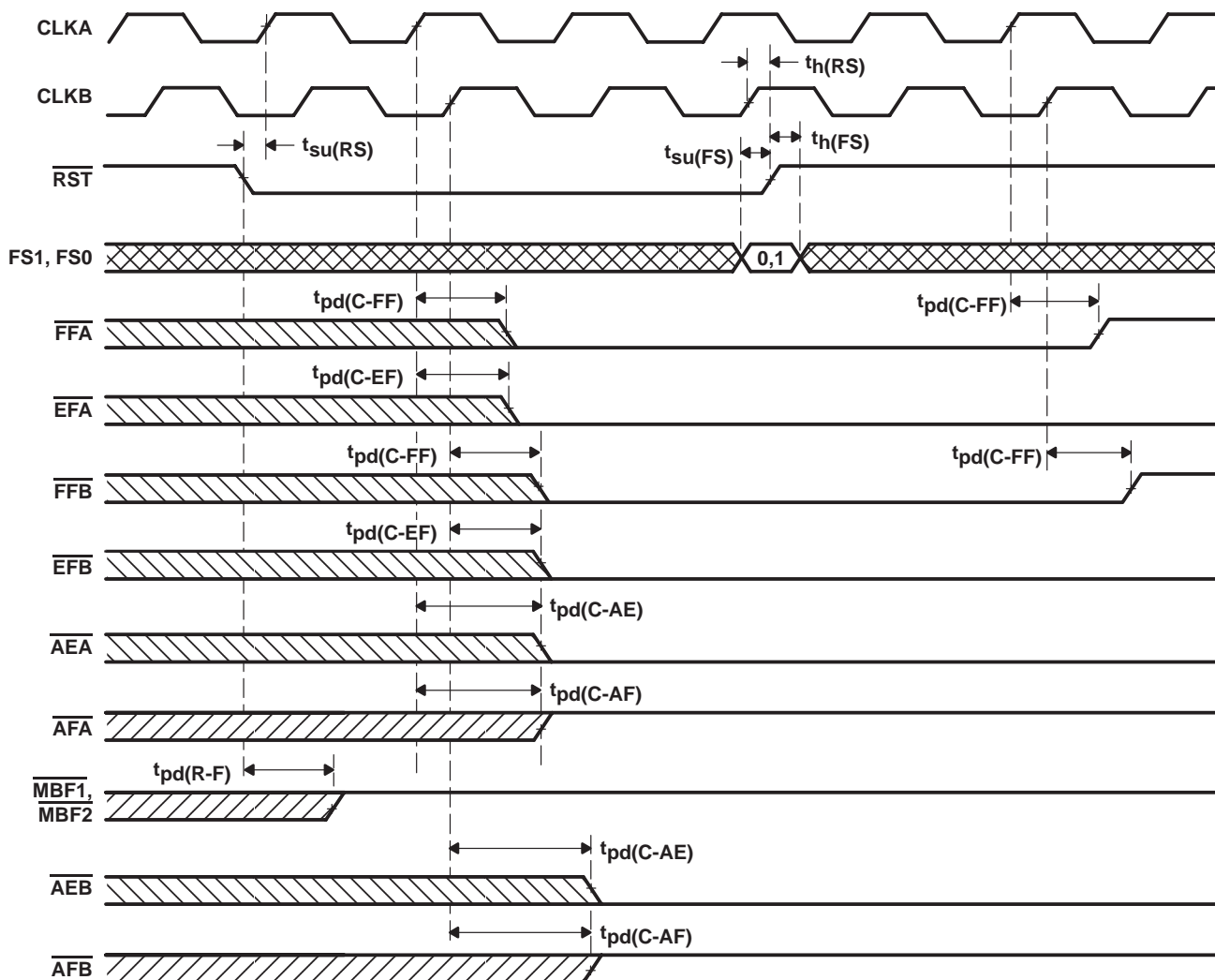
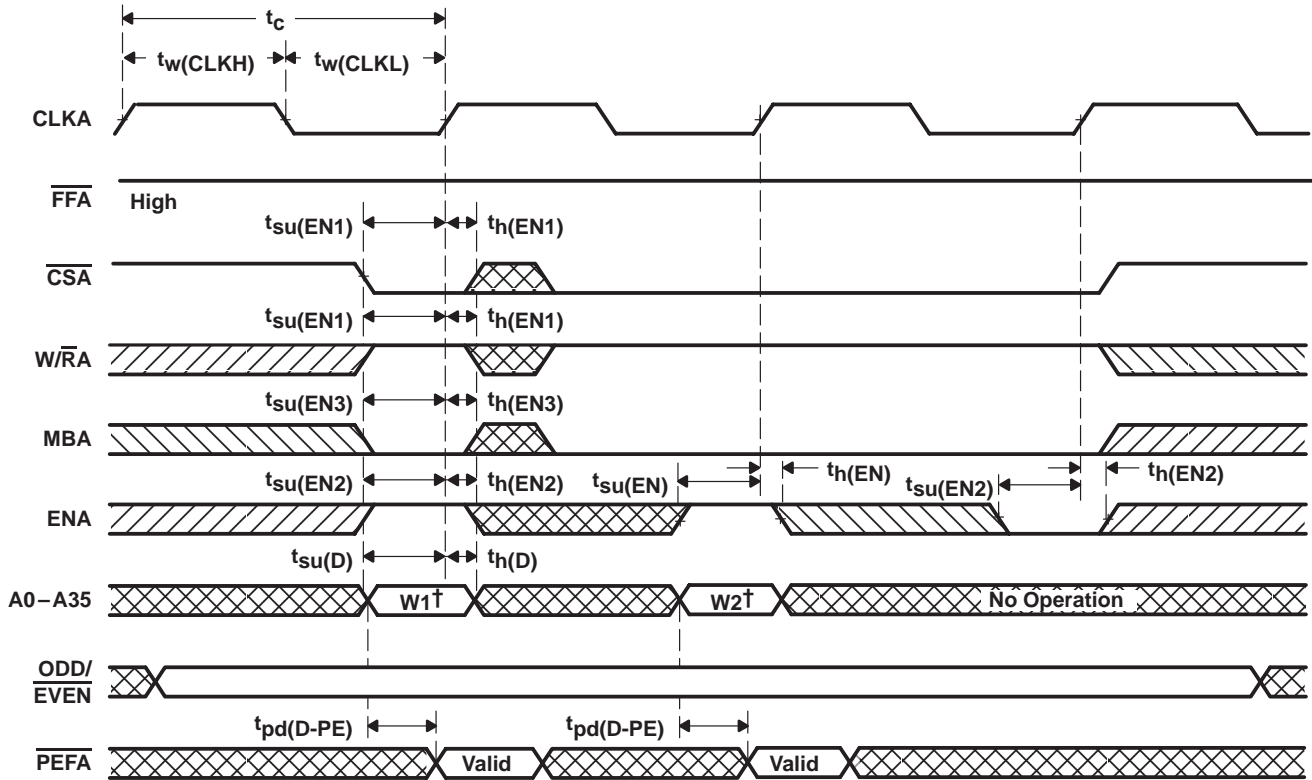

Figure 1. Device Reset Loading the X Register With the Value of Eight



† Written to FIFO1

Figure 2. Port-A Write-Cycle Timing for FIFO1

CLOCKED BIDIRECTIONAL FIRST-IN, FIRST-OUT MEMORY

SCBS129G – JULY 1992 – REVISED APRIL 1998

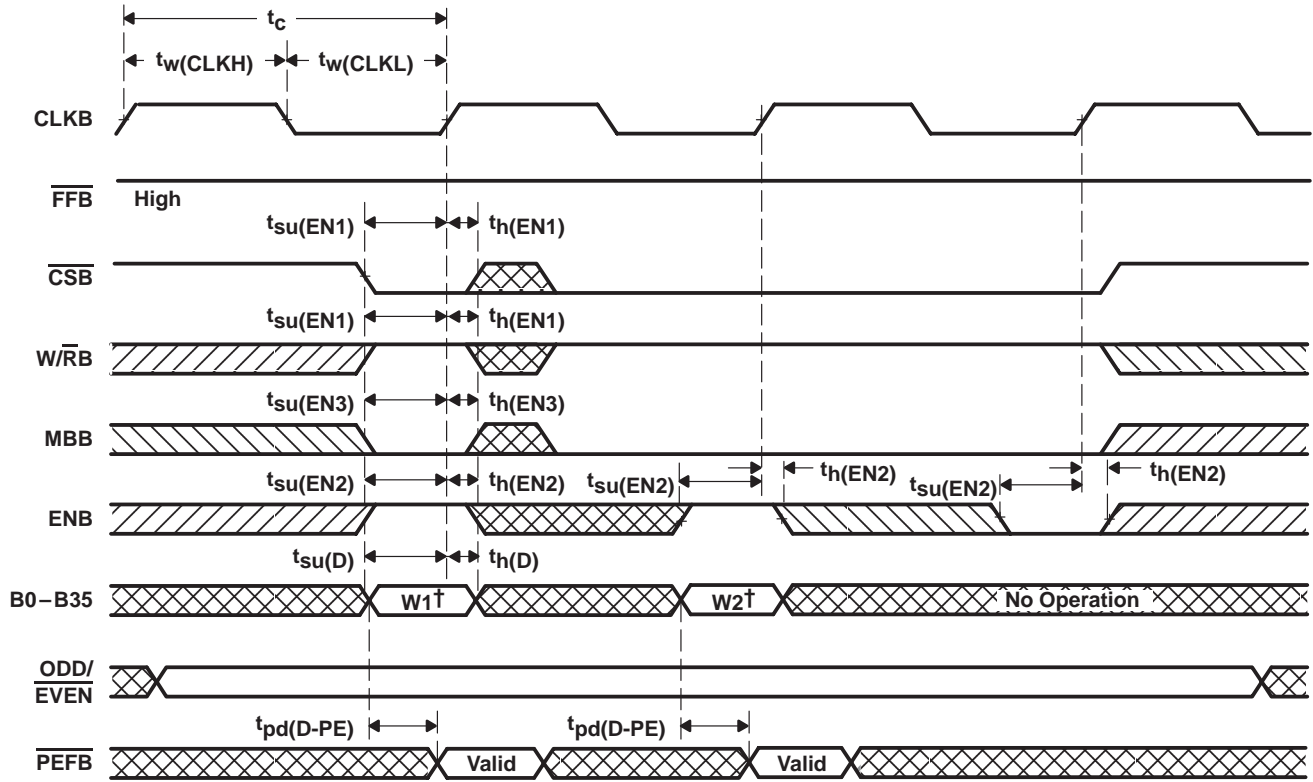

† Written to FIFO2

Figure 3. Port-B Write-Cycle Timing for FIFO2

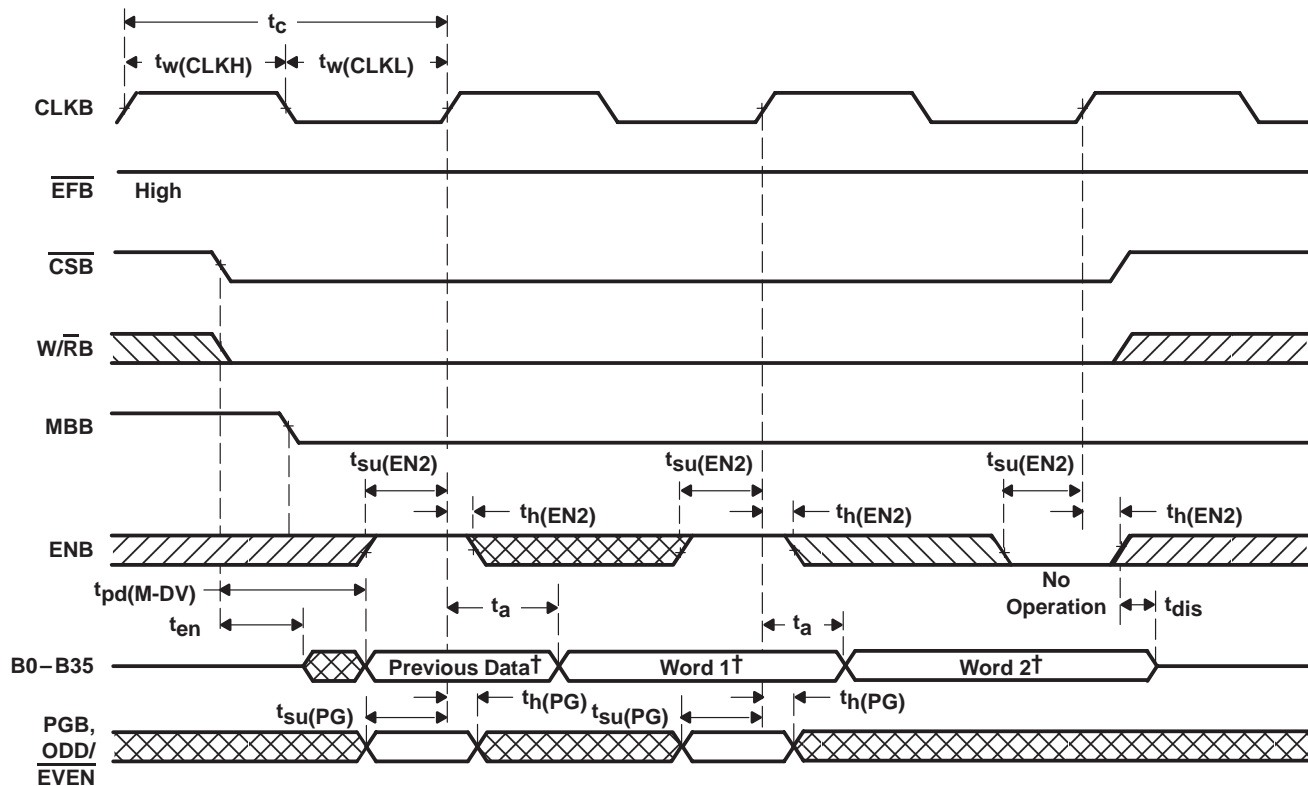

† Read from FIFO1

Figure 4. Port-B Read-Cycle Timing for FIFO1

CLOCKED BIDIRECTIONAL FIRST-IN, FIRST-OUT MEMORY

SCBS129G – JULY 1992 – REVISED APRIL 1998

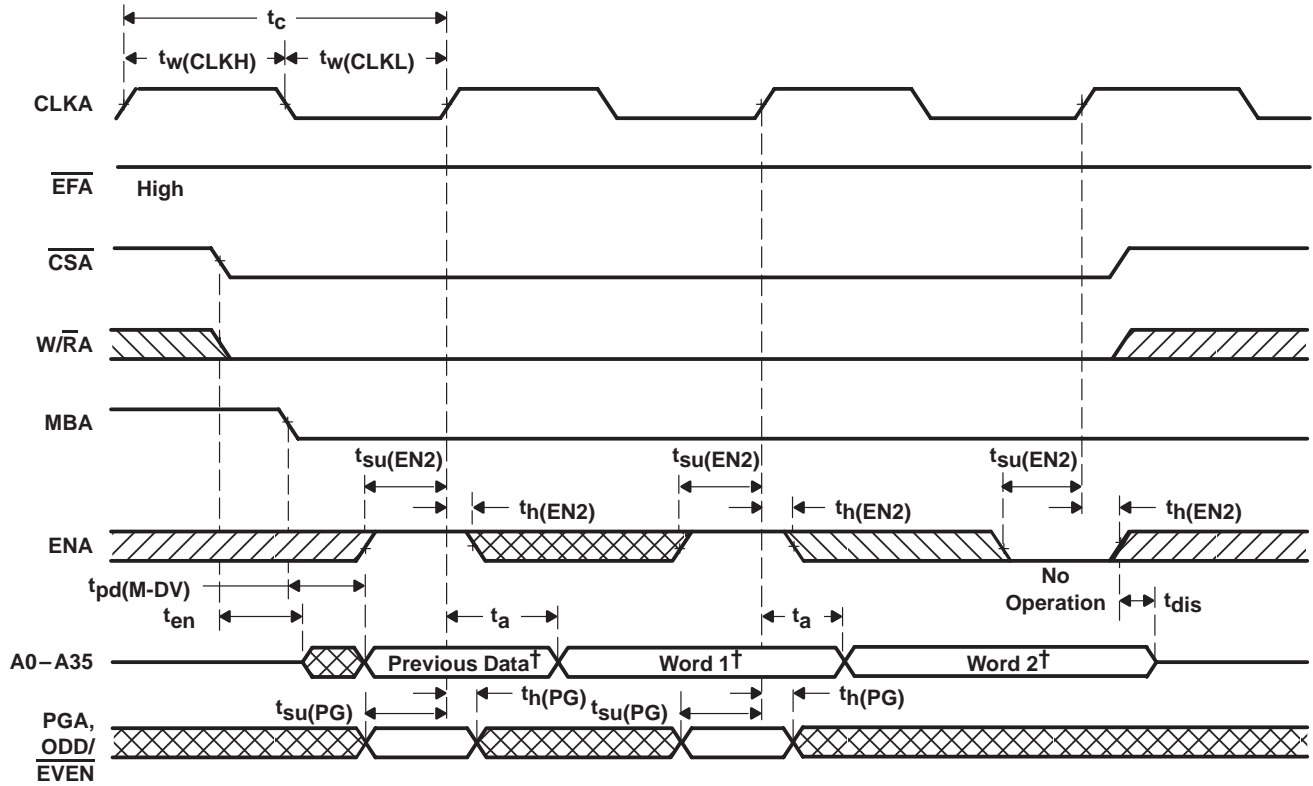

† Read from FIFO2

Figure 5. Port-A Read-Cycle Timing for FIFO2

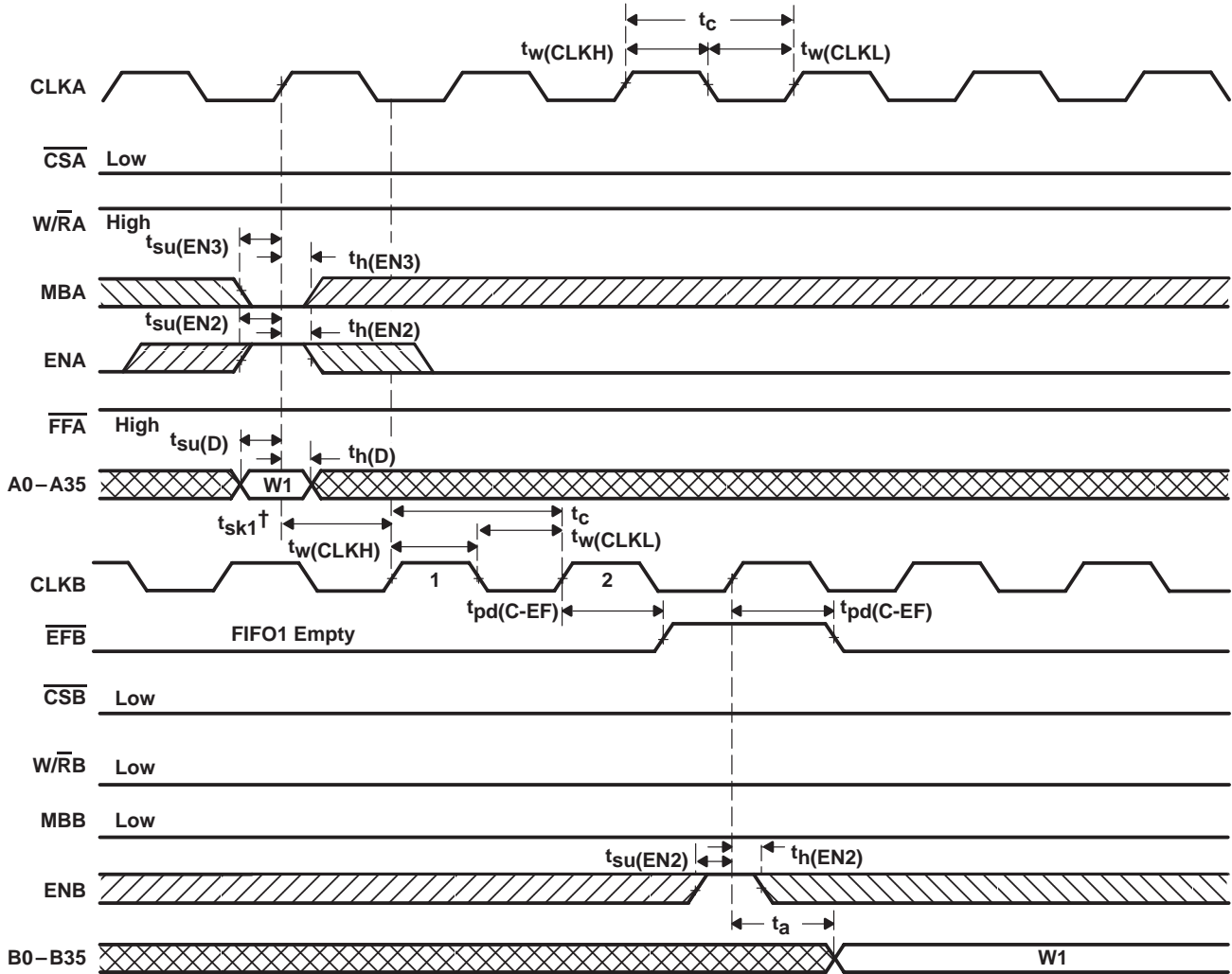

†  $t_{sk1}$  is the minimum time between a rising CLKA edge and a rising CLKB edge for  $\overline{EFB}$  to transition high in the next CLKB cycle. If the time between the rising CLKA edge and rising CLKB edge is less than  $t_{sk1}$ , the transition of  $\overline{EFB}$  high may occur one CLKB cycle later than shown.

Figure 6.  $\overline{EFB}$ -Flag Timing and First Data Read When FIFO1 Is Empty



CLOCKED BIDIRECTIONAL FIRST-IN, FIRST-OUT MEMORY

SCBS129G – JULY 1992 – REVISED APRIL 1998

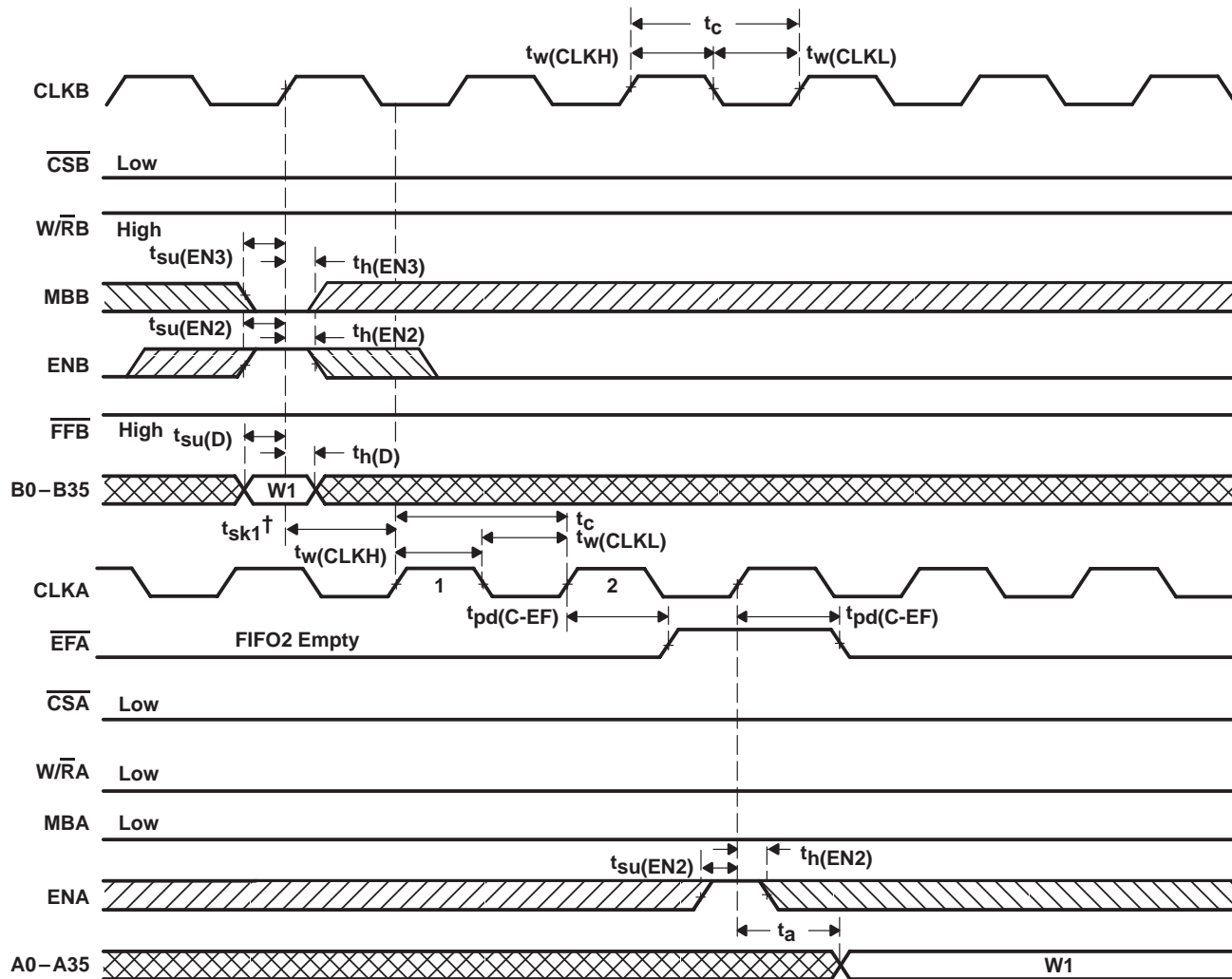

†  $t_{sk1}$  is the minimum time between a rising CLKB edge and a rising CLKA edge for  $\overline{\text{EFA}}$  to transition high in the next CLKA cycle. If the time between the rising CLKB edge and rising CLKA edge is less than  $t_{sk1}$ , the transition of  $\overline{\text{EFA}}$  high may occur one CLKA cycle later than shown.

Figure 7.  $\overline{\text{EFA}}$ -Flag Timing and First Data Read When FIFO2 Is Empty

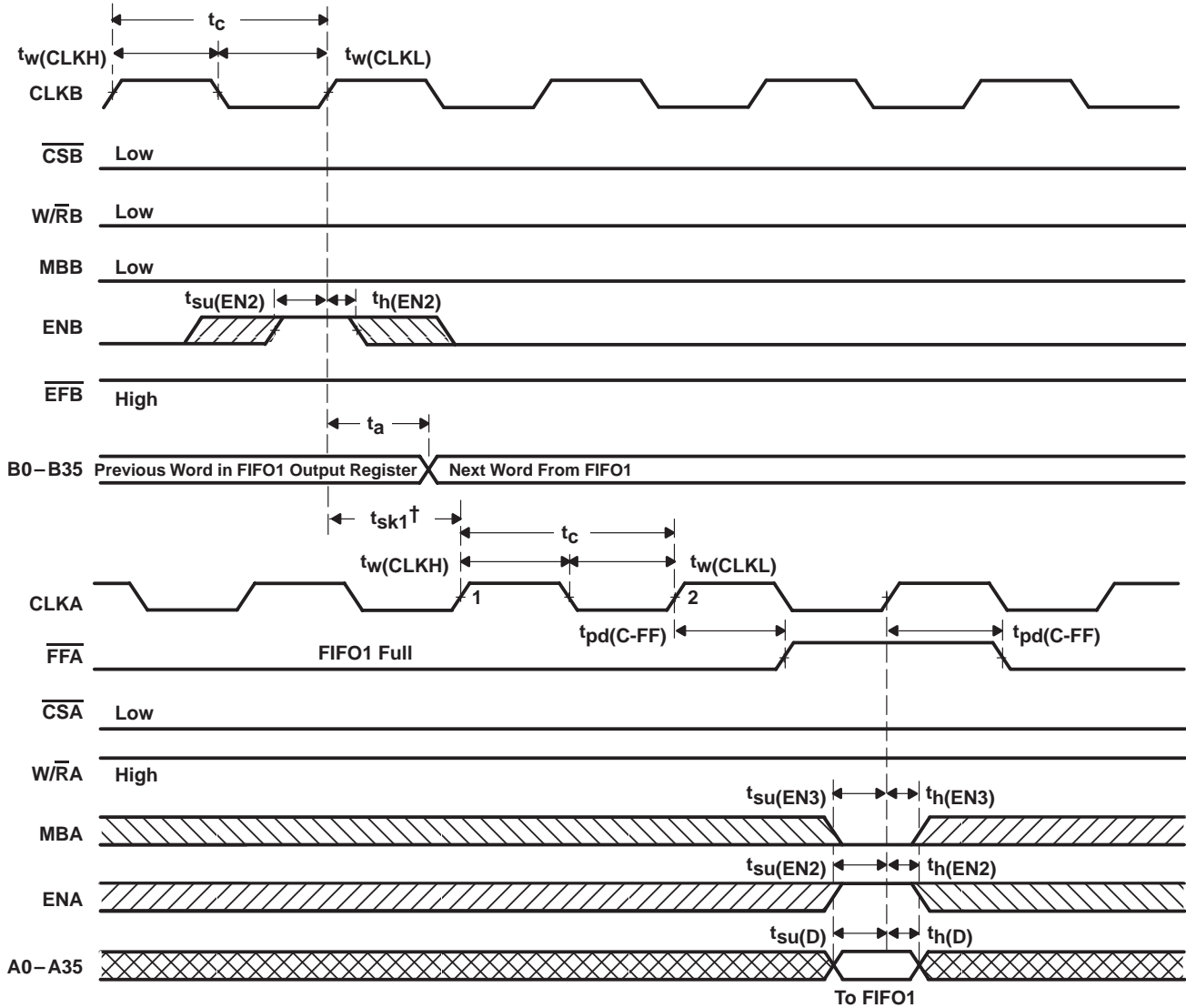

$^\dagger t_{sk1}$  is the minimum time between a rising CLKB edge and a rising CLKA edge for  $\overline{FFA}$  to transition high in the next CLKA cycle. If the time between the rising CLKB edge and rising CLKA edge is less than  $t_{sk1}$ ,  $\overline{FFA}$  may transition high one CLKA cycle later than shown.

Figure 8.  $\overline{FFA}$ -Flag Timing and First Available Write When FIFO1 Is Full

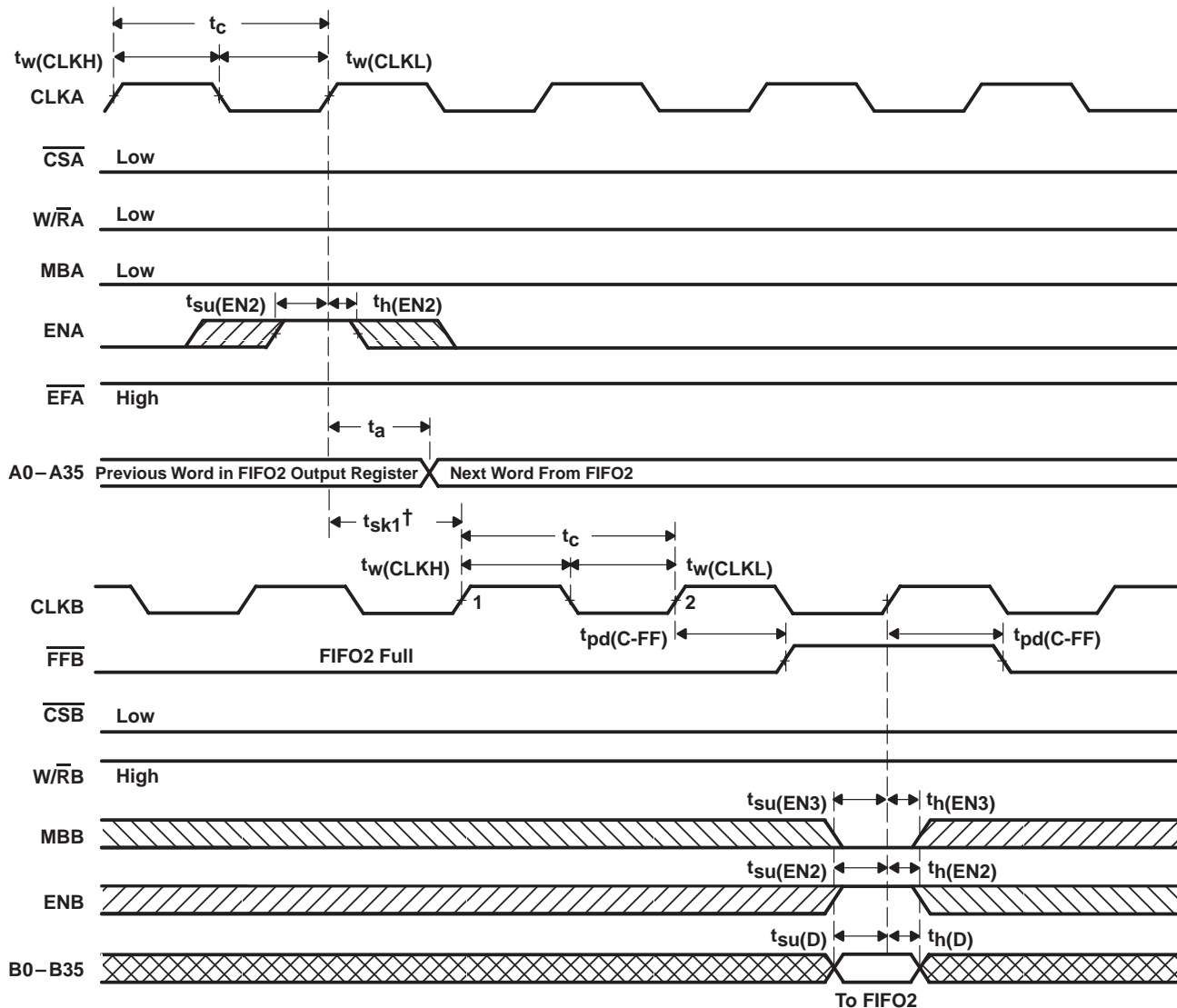

$^\dagger t_{sk1}$  is the minimum time between a rising CLKA edge and a rising CLKB edge for  $\overline{\text{FFB}}$  to transition high in the next CLKB cycle. If the time between the rising CLKA edge and rising CLKB edge is less than  $t_{sk1}$ ,  $\overline{\text{FFB}}$  may transition high one CLKB cycle later than shown.

Figure 9.  $\overline{\text{FFB}}$ -Flag Timing and First Available Write When FIFO2 Is Full

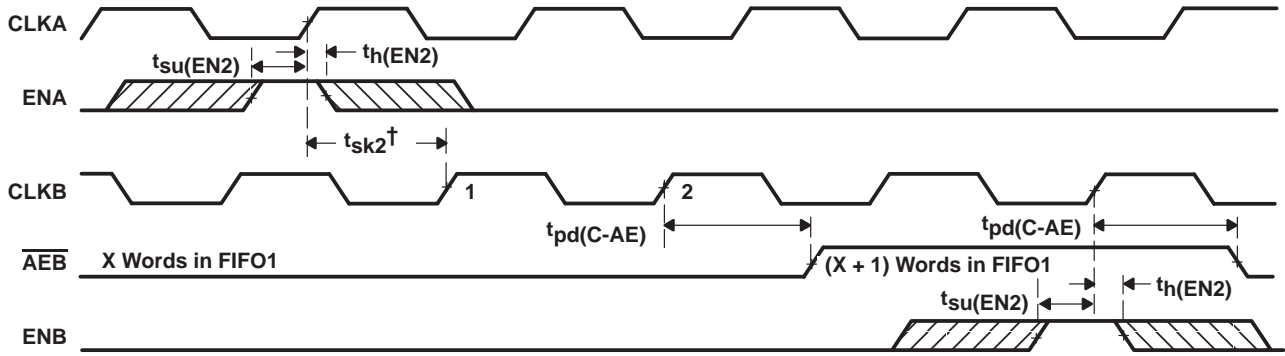

$^\dagger t_{sk2}$  is the minimum time between a rising CLKA edge and a rising CLKB edge for  $\overline{AEB}$  to transition high in the next CLKB cycle. If the time between the rising CLKA edge and rising CLKB edge is less than  $t_{sk2}$ ,  $\overline{AEB}$  may transition high one CLKB cycle later than shown.  
 NOTE A: FIFO1 write ( $\overline{CSA} = L, W/\overline{RA} = H, MBA = L$ ), FIFO1 read ( $\overline{CSB} = L, W/\overline{RB} = L, MBB = L$ ).

Figure 10. Timing for  $\overline{AEB}$  When FIFO1 Is Almost Empty

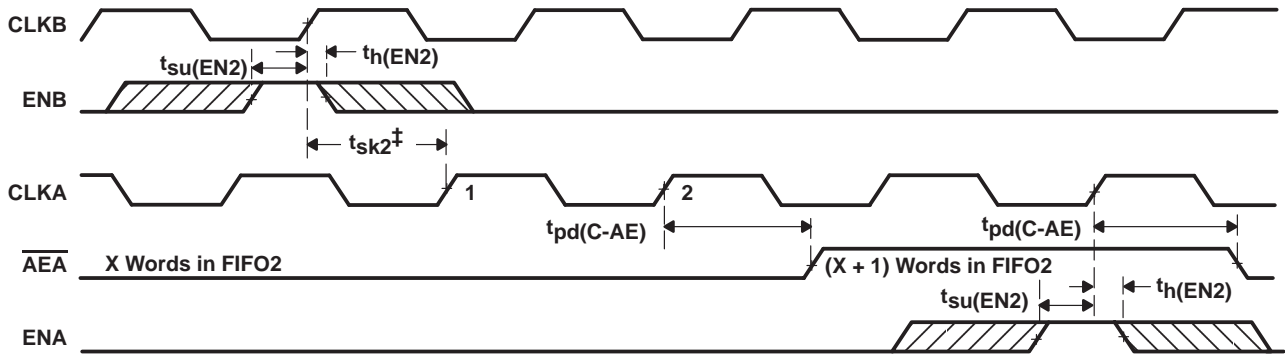

$^\ddagger t_{sk2}$  is the minimum time between a rising CLKB edge and a rising CLKA edge for  $\overline{AEA}$  to transition high in the next CLKA cycle. If the time between the rising CLKB edge and rising CLKA edge is less than  $t_{sk2}$ ,  $\overline{AEA}$  may transition high one CLKA cycle later than shown.  
 NOTE A: FIFO2 write ( $\overline{CSB} = L, W/\overline{RB} = H, MBB = L$ ), FIFO2 read ( $\overline{CSA} = L, W/\overline{RA} = L, MBA = L$ ).

Figure 11. Timing for  $\overline{AEA}$  When FIFO2 Is Almost Empty



CLOCKED BIDIRECTIONAL FIRST-IN, FIRST-OUT MEMORY

SCBS129G – JULY 1992 – REVISED APRIL 1998

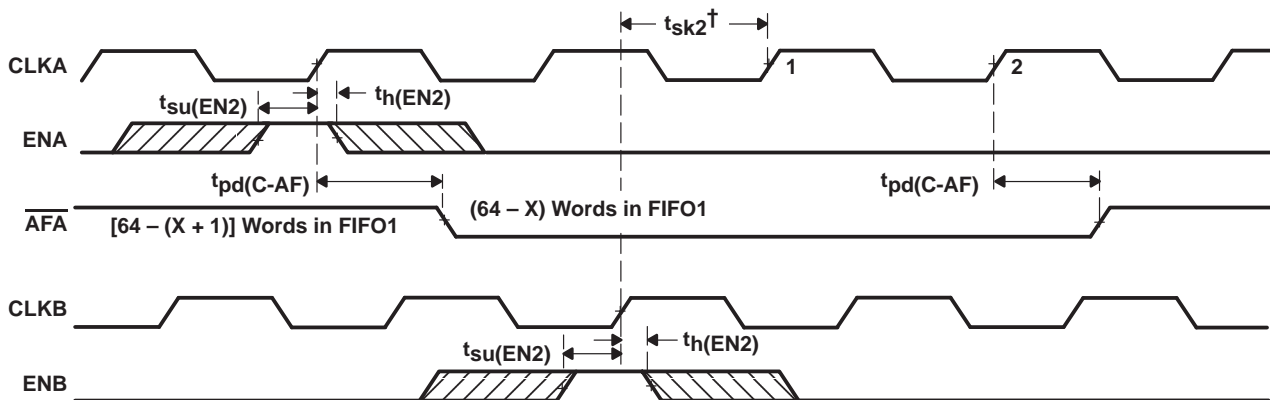

†  $t_{sk2}$  is the minimum time between a rising CLKA edge and a rising CLKB edge for  $\overline{AFA}$  to transition high in the next CLKA cycle. If the time between the rising CLKA edge and rising CLKB edge is less than  $t_{sk2}$ ,  $\overline{AFA}$  may transition high one CLKB cycle later than shown.  
 NOTE A: FIFO1 write ( $\overline{CSA} = L, W/\overline{RA} = H, MBA = L$ ), FIFO1 read ( $\overline{CSB} = L, W/\overline{RB} = L, MBB = L$ ).

Figure 12. Timing for  $\overline{AFA}$  When FIFO1 Is Almost Full

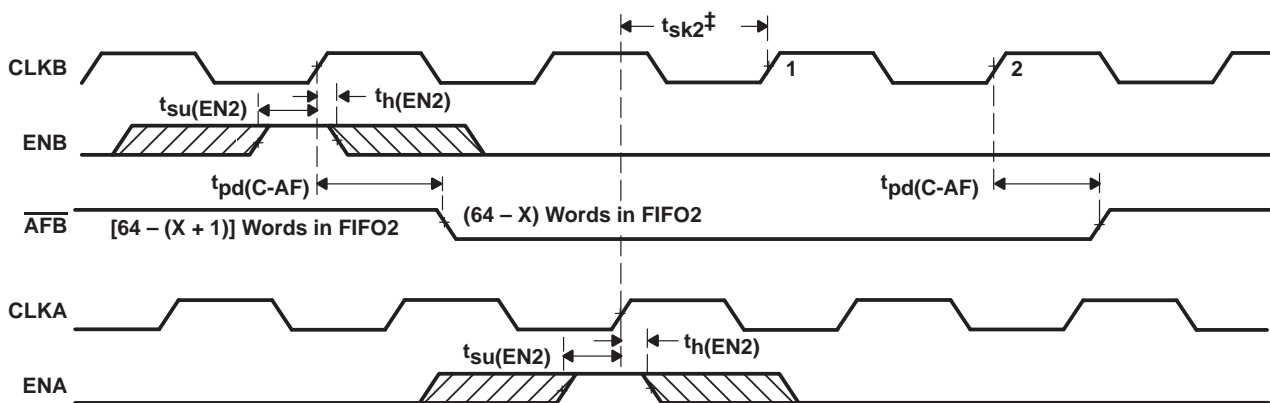

‡  $t_{sk2}$  is the minimum time between a rising CLKB edge and a rising CLKA edge for  $\overline{AFB}$  to transition high in the next CLKB cycle. If the time between the rising CLKB edge and rising CLKA edge is less than  $t_{sk2}$ ,  $\overline{AFB}$  may transition high one CLKA cycle later than shown.  
 NOTE A: FIFO2 write ( $\overline{CSB} = L, W/\overline{RB} = H, MBB = L$ ), FIFO2 read ( $\overline{CSA} = L, W/\overline{RA} = L, MBA = L$ ).

Figure 13. Timing for  $\overline{AFB}$  When FIFO2 Is Almost Full

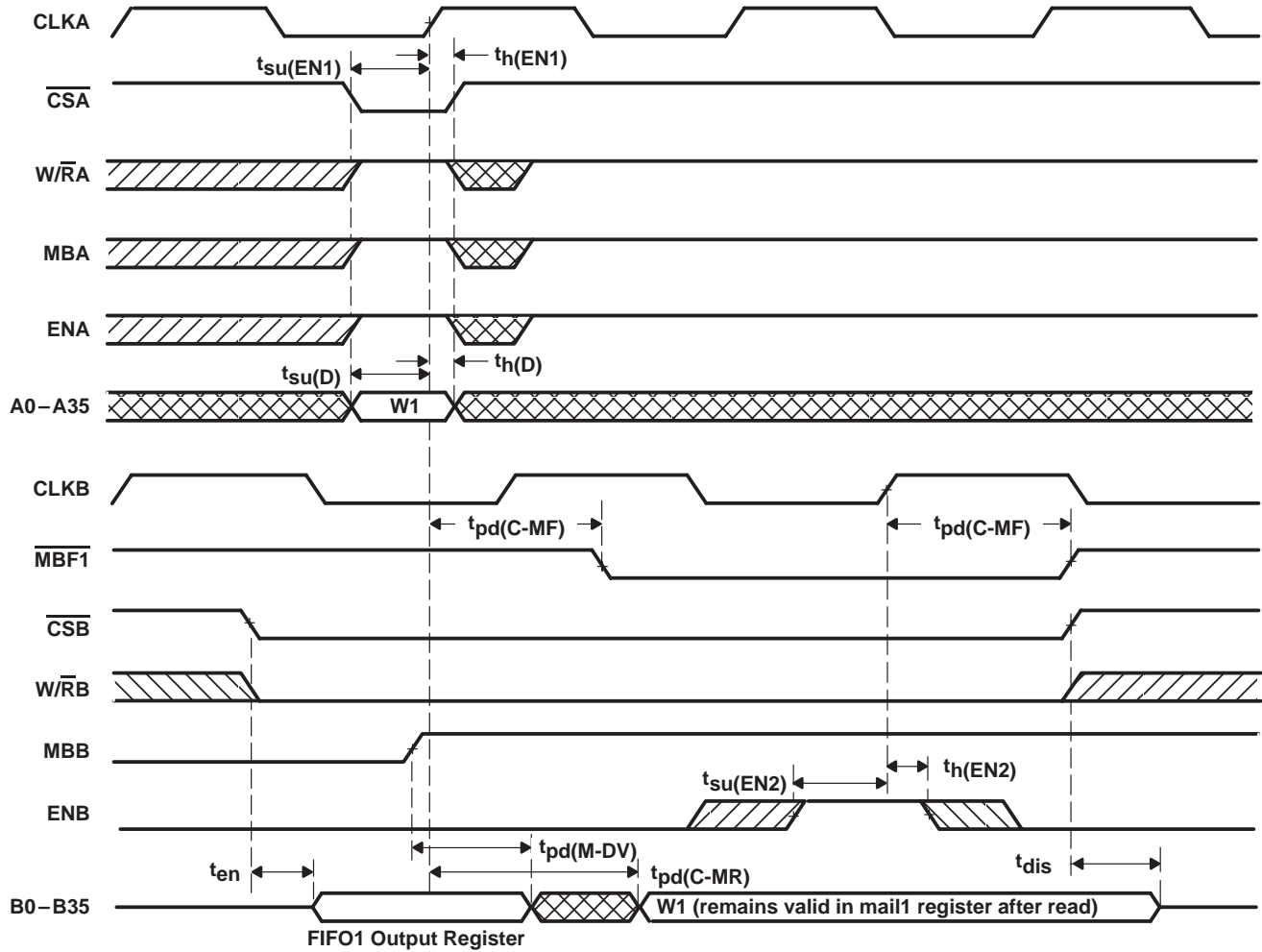

NOTE A: Port-B parity generation off (PGB = L)

Figure 14. Timing for Mail1 Register and  $\overline{MBF1}$  Flag

CLOCKED BIDIRECTIONAL FIRST-IN, FIRST-OUT MEMORY

SCBS129G – JULY 1992 – REVISED APRIL 1998

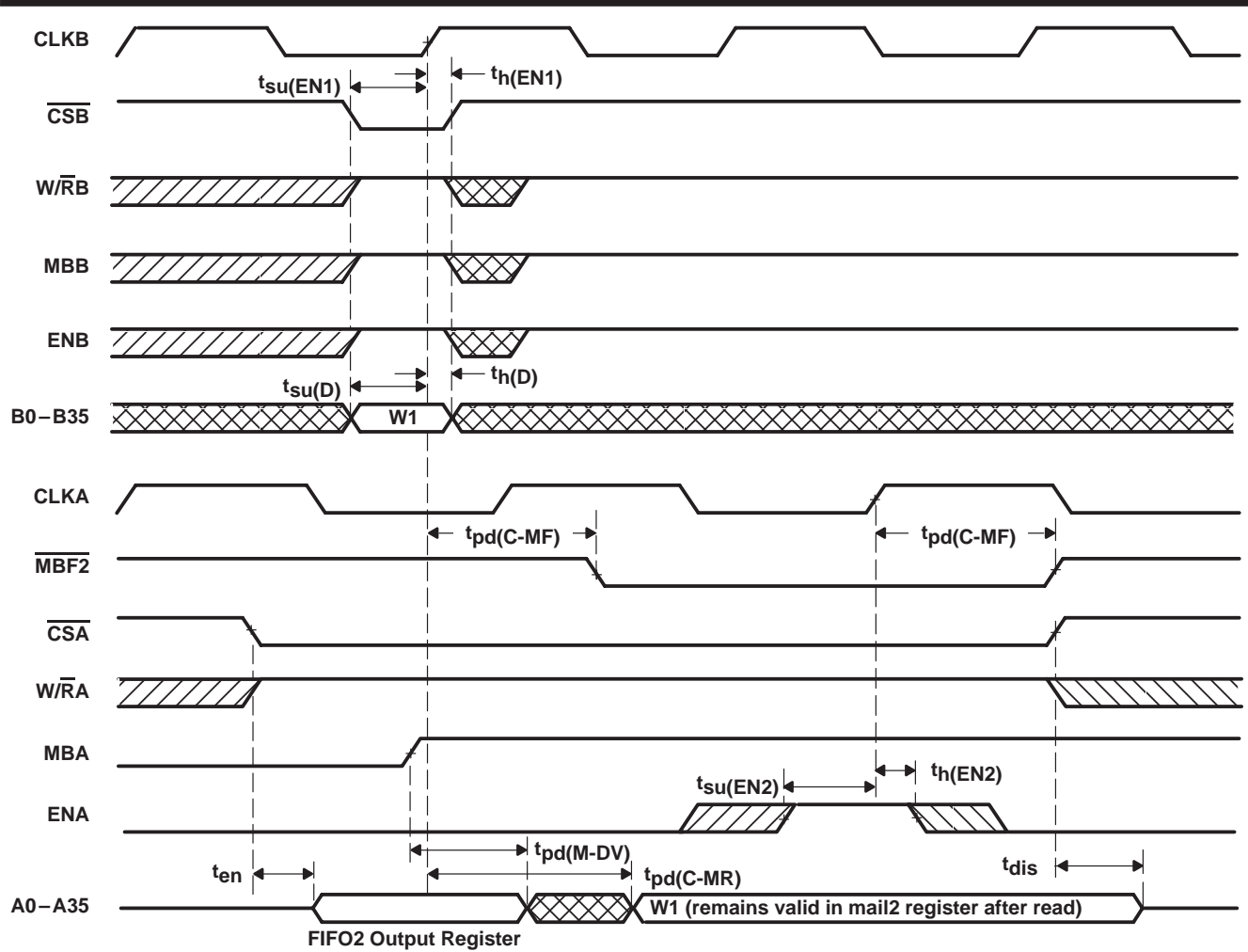

NOTE A: Port-A parity generation off (PGA = L)

Figure 15. Timing for Mail2 Register and  $\overline{MBF2}$  Flag

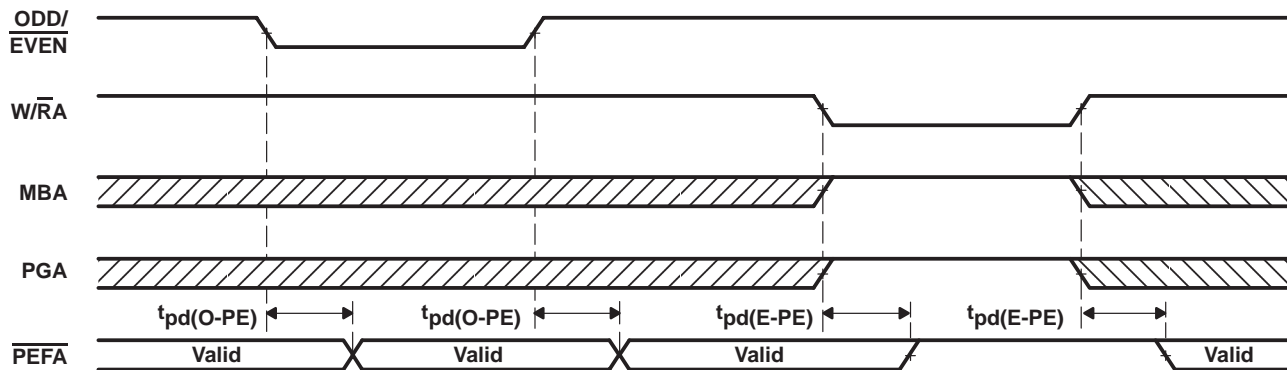

NOTE A:  $\overline{CSA} = L, ENA = H$

Figure 16. ODD/EVEN, W/RA, MBA, and PGA to PEFA Timing

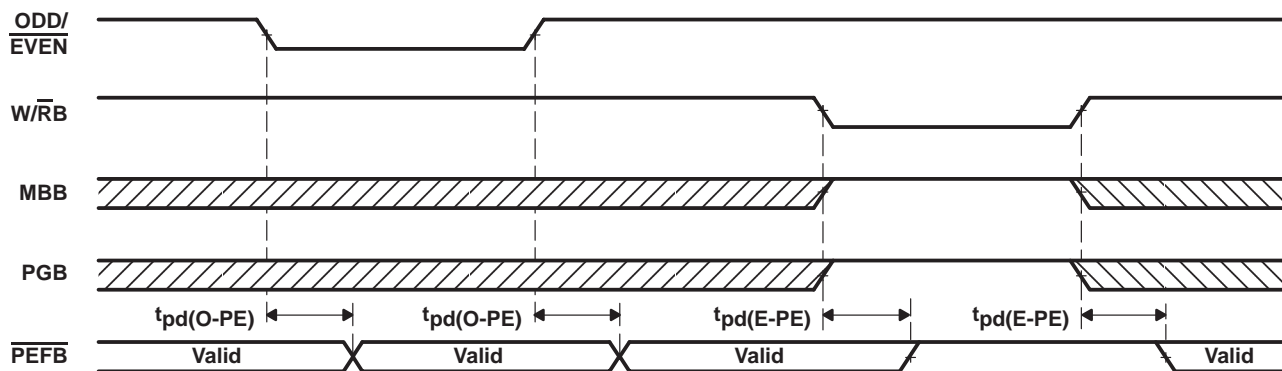

NOTE A:  $\overline{CSB} = L, ENB = H$

Figure 17. ODD/EVEN, W/RB, MBB, and PGB to PEFB Timing



CLOCKED BIDIRECTIONAL FIRST-IN, FIRST-OUT MEMORY

SCBS129G – JULY 1992 – REVISED APRIL 1998

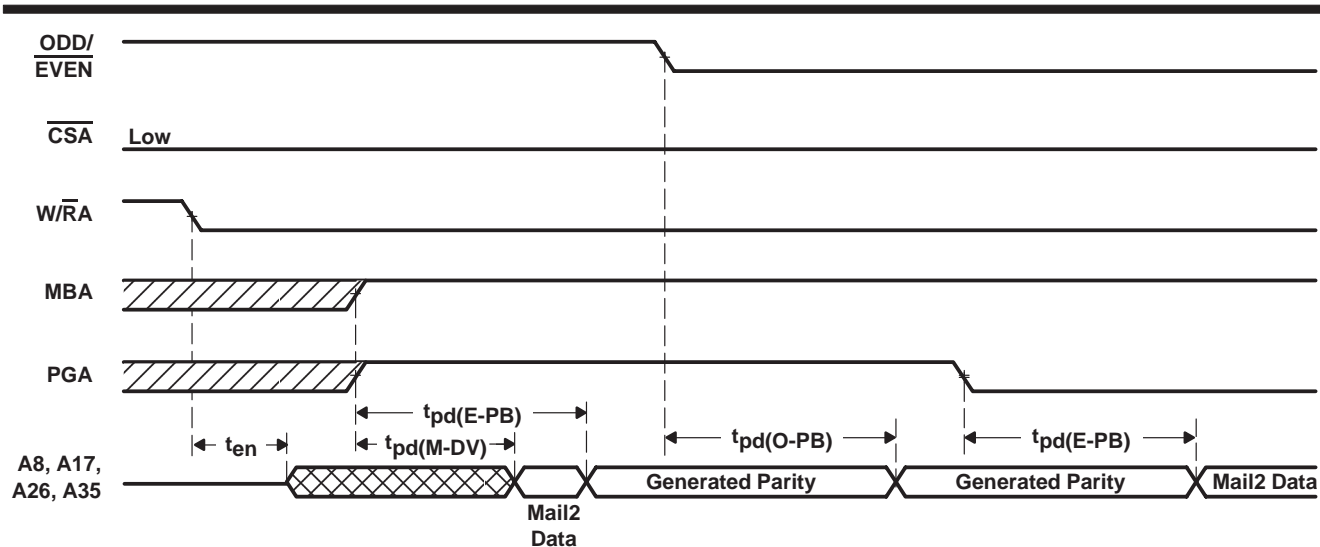

NOTE A: ENA = H

Figure 18. Parity-Generation Timing When Reading From the Mail2 Register

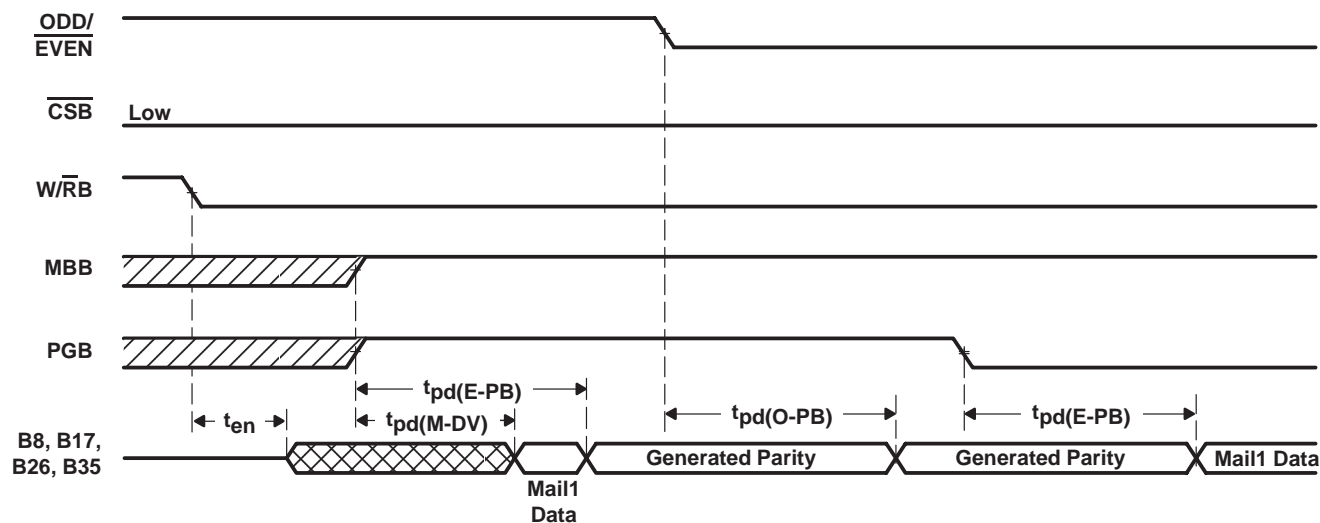

NOTE A: ENB = H

Figure 19. Parity-Generation Timing When Reading From the Mail1 Register

**absolute maximum ratings over operating free-air temperature range (unless otherwise noted)†**

Supply voltage range, $V_{CC}$ .....	-0.5 V to 7 V
Input voltage range, $V_I$ (see Note 1) .....	-0.5 V to $V_{CC} + 0.5$ V
Output voltage range, $V_O$ (see Note 1) .....	-0.5 V to $V_{CC} + 0.5$ V
Input clamp current, $I_{IK}$ ( $V_I < 0$ or $V_I > V_{CC}$ ) .....	±20 mA
Output clamp current, $I_{OK}$ ( $V_O < 0$ or $V_O > V_{CC}$ ) .....	±50 mA
Continuous output current, $I_O$ ( $V_O = 0$ to $V_{CC}$ ) .....	±50 mA
Continuous current through $V_{CC}$ or GND .....	±500 mA
Package thermal impedance, $\theta_{JA}$ (see Note 2): PCB package .....	28°C/W
PQ package .....	46°C/W
Storage temperature range, $T_{stg}$ .....	-65°C to 150°C

† Stresses beyond those listed under “absolute maximum ratings” may cause permanent damage to the device. These are stress ratings only, and functional operation of the device at these or any other conditions beyond those indicated under “recommended operating conditions” is not implied. Exposure to absolute-maximum-rated conditions for extended periods may affect device reliability.

- NOTES: 1. The input and output voltage ratings may be exceeded provided the input and output current ratings are observed.  
 2. The package thermal impedance is calculated in accordance with JESD 51.

**recommended operating conditions**

	MIN	MAX	UNIT
$V_{CC}$ Supply voltage	4.5	5.5	V
$V_{IH}$ High-level input voltage	2		V
$V_{IL}$ Low-level input voltage		0.8	V
$I_{OH}$ High-level output current		-4	mA
$I_{OL}$ Low-level output current		8	mA
$T_A$ Operating free-air temperature	0	70	°C

**electrical characteristics over recommended operating free-air temperature range (unless otherwise noted)**

PARAMETER	TEST CONDITIONS	MIN	TYP‡	MAX	UNIT
$V_{OH}$	$V_{CC} = 4.5$ V, $I_{OH} = -4$ mA	2.4			V
$V_{OL}$	$V_{CC} = 4.5$ V, $I_{OL} = 8$ mA			0.5	V
$I_I$	$V_{CC} = 5.5$ V, $V_I = V_{CC}$ or 0			±50	µA
$I_{OZ}$	$V_{CC} = 5.5$ V, $V_O = V_{CC}$ or 0			±50	µA
$I_{CC}$	$V_{CC} = 5.5$ V, $I_O = 0$ mA, $V_I = V_{CC}$ or GND	Outputs high		60	mA
		Outputs low		130	mA
		Outputs disabled		60	mA
$C_i$	$V_I = 0$ , $f = 1$ MHz		4		pF
$C_o$	$V_O = 0$ , $f = 1$ MHz		8		pF

‡ All typical values are at  $V_{CC} = 5$  V,  $T_A = 25^\circ\text{C}$ .

## CLOCKED BIDIRECTIONAL FIRST-IN, FIRST-OUT MEMORY

SCBS129G – JULY 1992 – REVISED APRIL 1998

timing requirements over recommended ranges of supply voltage and operating free-air temperature (see Figures 1 through 20)

		'ABT3612-15		'ABT3612-20		'ABT3612-30		UNIT
		MIN	MAX	MIN	MAX	MIN	MAX	
$f_{\text{clock}}$	Clock frequency, CLKA or CLKB	66.7		50		33.4		MHz
$t_{\text{c}}$	Clock cycle time, CLKA or CLKB	15		20		30		ns
$t_{\text{w}}(\text{CLKH})$	Pulse duration, CLKA and CLKB high	6		8		12		ns
$t_{\text{w}}(\text{CLKL})$	Pulse duration, CLKA and CLKB low	6		8		12		ns
$t_{\text{su}}(\text{D})$	Setup time, A0–A35 before CLKA↑ and B0–B35 before CLKB↑	4		5		6		ns
$t_{\text{su}}(\text{EN1})$	Setup time, $\overline{\text{CSA}}$ , W/RA before CLKA↑; $\overline{\text{CSB}}$ , W/RB before CLKB↑	6		6		7		ns
$t_{\text{su}}(\text{EN2})$	Setup time, ENA before CLKA↑; ENB before CLKB↑	4		5		6		ns
$t_{\text{su}}(\text{EN3})$	Setup time, MBA before CLKA↑; MBB before CLKB↑	4		5		6		ns
$t_{\text{su}}(\text{PG})$	Setup time, ODD/EVEN and PGA before CLKA↑; ODD/EVEN and PGB before CLKB↑†	4		5		6		ns
$t_{\text{su}}(\text{RS})$	Setup time, $\overline{\text{RST}}$ low before CLKA↑ or CLKB↑‡	5		6		7		ns
$t_{\text{su}}(\text{FS})$	Setup time, FS0 and FS1 before $\overline{\text{RST}}$ high	5		6		7		ns
$t_{\text{h}}(\text{D})$	Hold time, A0–A35 after CLKA↑ and B0–B35 after CLKB↑	2.5		2.5		2.5		ns
$t_{\text{h}}(\text{EN1})$	Hold time, $\overline{\text{CSA}}$ , W/RA after CLKA↑; $\overline{\text{CSB}}$ , W/RB after CLKB↑	2		2		2		ns
$t_{\text{h}}(\text{EN2})$	Hold time, ENA after CLKA↑; ENB after CLKB↑	2.5		2.5		2.5		ns
$t_{\text{h}}(\text{EN3})$	Hold time, MBA after CLKA↑; MBB after CLKB↑	1		1		1		ns
$t_{\text{h}}(\text{PG})$	Hold time, ODD/EVEN and PGA after CLKA↑; ODD/EVEN and PGB after CLKB↑†	1		1		1		ns
$t_{\text{h}}(\text{RS})$	Hold time, $\overline{\text{RST}}$ low after CLKA↑ or CLKB↑‡	5		6		7		ns
$t_{\text{h}}(\text{FS})$	Hold time, FS0 and FS1 after $\overline{\text{RST}}$ high	4		4		4		ns
$t_{\text{sk1}}^{\S}$	Skew time between CLKA↑ and CLKB↑ for $\overline{\text{EFA}}$ , $\overline{\text{EFB}}$ , $\overline{\text{FFA}}$ , and $\overline{\text{FFB}}$	8		8		10		ns
$t_{\text{sk2}}^{\S}$	Skew time between CLKA↑ and CLKB↑ for $\overline{\text{AEA}}$ , $\overline{\text{AEB}}$ , $\overline{\text{AFA}}$ , and $\overline{\text{AFB}}$	9		16		20		ns

† Only applies for a clock edge that does a FIFO read

‡ Requirement to count the clock edge as one of at least four needed to reset a FIFO

§ Skew time is not a timing constraint for proper device operation and is included only to illustrate the timing relationship between CLKA cycle and CLKB cycle.

switching characteristics over recommended ranges of supply voltage and operating free-air temperature,  $C_L = 30$  pF (see Figures 1 through 20)

PARAMETER	'ABT3612-15		'ABT3612-20		'ABT3612-30		UNIT
	MIN	MAX	MIN	MAX	MIN	MAX	
$f_{max}$	66.7		50		33		MHz
$t_a$ Access time, $CLKA\uparrow$ to $A0-A35$ and $CLKB\uparrow$ to $B0-B35$	2	10	2	12	2	15	ns
$t_{pd}(C-FF)$ Propagation delay time, $CLKA\uparrow$ to $\overline{FFA}$ and $CLKB\uparrow$ to $\overline{FFB}$	2	10	2	12	2	15	ns
$t_{pd}(C-EF)$ Propagation delay time, $CLKA\uparrow$ to $\overline{EFA}$ and $CLKB\uparrow$ to $\overline{EFB}$	2	10	2	12	2	15	ns
$t_{pd}(C-AE)$ Propagation delay time, $CLKA\uparrow$ to $\overline{AEA}$ and $CLKB\uparrow$ to $\overline{AEB}$	2	10	2	12	2	15	ns
$t_{pd}(C-AF)$ Propagation delay time, $CLKA\uparrow$ to $\overline{AFA}$ and $CLKB\uparrow$ to $\overline{AFB}$	2	10	2	12	2	15	ns
$t_{pd}(C-MF)$ Propagation delay time, $CLKA\uparrow$ to $\overline{MBF1}$ low or $\overline{MBF2}$ high and $CLKB\uparrow$ to $\overline{MBF2}$ low or $\overline{MBF1}$ high	1	9	1	12	1	15	ns
$t_{pd}(C-MR)$ Propagation delay time, $CLKA\uparrow$ to $B0-B35\uparrow$ and $CLKB\uparrow$ to $A0-A35\uparrow$	3	11	3	13	3	15	ns
$t_{pd}(M-DV)$ Propagation delay time, $MBA$ to $A0-A35$ valid and $MBB$ to $B0-B35$ valid	1	11	1	11.5	1	12	ns
$t_{pd}(D-PE)$ Propagation delay time, $A0-A35$ valid to $\overline{PEFA}$ valid; $B0-B35$ valid to $\overline{PEFB}$ valid	3	10	3	11	3	13	ns
$t_{pd}(O-PE)$ Propagation delay time, $ODD/EVEN$ to $\overline{PEFA}$ and $\overline{PEFB}$	3	11	3	12	3	14	ns
$t_{pd}(O-PB)\S$ Propagation delay time, $ODD/EVEN$ to parity bits ( $A8, A17, A26, A35$ ) and ( $B8, B17, B26, B35$ )	2	11	2	12	2	14	ns
$t_{pd}(E-PE)$ Propagation delay time, $W/\overline{RA}, \overline{CSA}, \overline{ENA}, \overline{MBA}$ , or $\overline{PGA}$ to $\overline{PEFA}$ ; $W/\overline{RB}, \overline{CSB}, \overline{ENB}, \overline{MBB}$ , or $\overline{PGB}$ to $\overline{PEFB}$	1	11	1	12	1	14	ns
$t_{pd}(E-PB)\S$ Propagation delay time, $W/\overline{RA}, \overline{CSA}, \overline{ENA}, \overline{MBA}$ , or $\overline{PGA}$ to parity bits ( $A8, A17, A26, A35$ ); $W/\overline{RB}, \overline{CSB}, \overline{ENB}, \overline{MBB}$ , or $\overline{PGB}$ to parity bits ( $B8, B17, B26, B35$ )	3	12	3	13	3	14	ns
$t_{pd}(R-F)$ Propagation delay time, $\overline{RST}$ to ( $\overline{AEA}, \overline{AEB}$ ) low and ( $\overline{AFA}, \overline{AFB}, \overline{MBF1}, \overline{MBF2}$ ) high.	1	15	1	20	1	30	ns
$t_{en}$ Enable time, $\overline{CSA}$ and $W/\overline{RA}$ low to $A0-A35$ active and $\overline{CSB}$ low and $W/\overline{RB}$ high to $B0-B35$ active	2	10	2	12	2	14	ns
$t_{dis}$ Disable time, $\overline{CSA}$ or $W/\overline{RA}$ high to $A0-A35$ at high impedance and $\overline{CSB}$ high or $W/\overline{RB}$ low to $B0-B35$ at high impedance	1	8	1	9	1	11	ns

† Writing data to the mail1 register when the  $B0-B35$  outputs are active and  $MBB$  is high

‡ Writing data to the mail2 register when the  $A0-A35$  outputs are active and  $MBA$  is high

§ Only applies when reading data from a mail register



PARAMETER MEASUREMENT INFORMATION

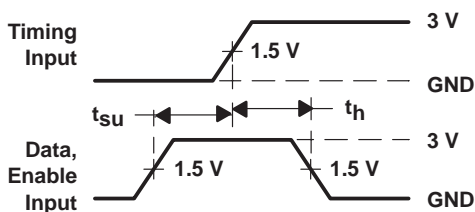
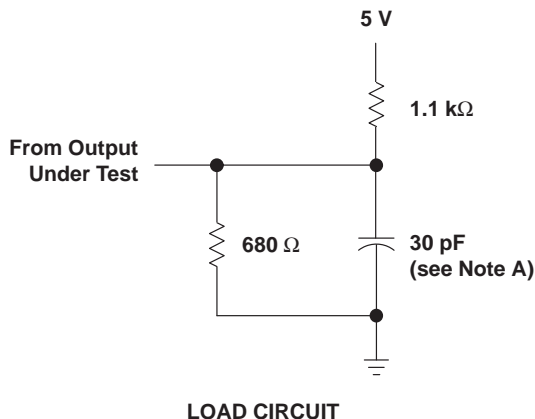

VOLTAGE WAVEFORMS  
SETUP AND HOLD TIMES

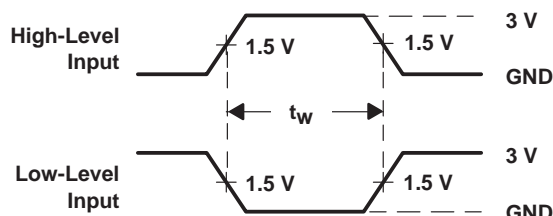

VOLTAGE WAVEFORMS  
PULSE DURATIONS

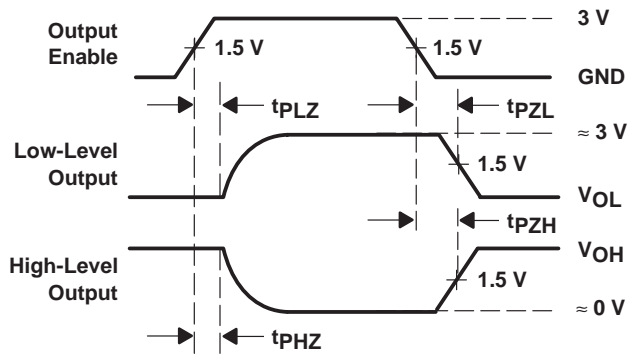

VOLTAGE WAVEFORMS  
ENABLE AND DISABLE TIMES

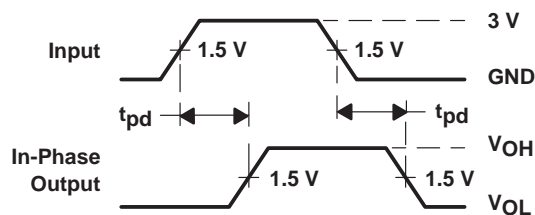

VOLTAGE WAVEFORMS  
PROPAGATION DELAY TIMES

- NOTES: A. Includes probe and jig capacitance  
 B.  $t_{pZL}$  and  $t_{pZH}$  are the same as  $t_{en}$ .  
 C.  $t_{pLZ}$  and  $t_{pHZ}$  are the same as  $t_{dis}$ .

Figure 20. Load Circuit and Voltage Waveforms

TYPICAL CHARACTERISTICS

SUPPLY CURRENT  
vs  
CLOCK FREQUENCY

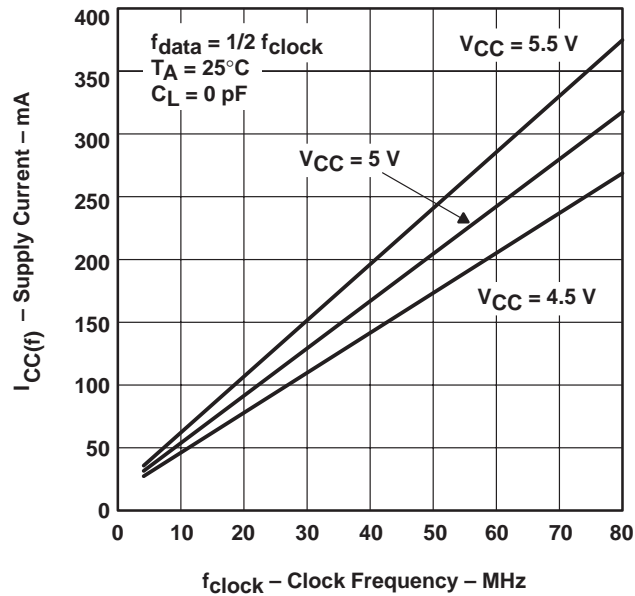

Figure 21



**PACKAGING INFORMATION**

Orderable Device	Status <sup>(1)</sup>	Package Type	Package Drawing	Pins	Package Qty	Eco Plan <sup>(2)</sup>	Lead/Ball Finish	MSL Peak Temp <sup>(3)</sup>
SN74ABT3612-15PCB	ACTIVE	HLQFP	PCB	120	90	Green (RoHS & no Sb/Br)	CU NIPDAU	Level-3-260C-168 HR
SN74ABT3612-15PQ	ACTIVE	BQFP	PQ	132	36	Green (RoHS & no Sb/Br)	CU NIPDAU	Level-4-260C-72 HR
SN74ABT3612-15PQG4	ACTIVE	BQFP	PQ	132	36	Green (RoHS & no Sb/Br)	CU NIPDAU	Level-4-260C-72 HR
SN74ABT3612-20PQ	ACTIVE	BQFP	PQ	132	36	Green (RoHS & no Sb/Br)	CU NIPDAU	Level-4-260C-72 HR
SN74ABT3612-30PQ	ACTIVE	BQFP	PQ	132	36	Green (RoHS & no Sb/Br)	CU NIPDAU	Level-4-260C-72 HR

<sup>(1)</sup> The marketing status values are defined as follows:

**ACTIVE:** Product device recommended for new designs.

**LIFEBUY:** TI has announced that the device will be discontinued, and a lifetime-buy period is in effect.

**NRND:** Not recommended for new designs. Device is in production to support existing customers, but TI does not recommend using this part in a new design.

**PREVIEW:** Device has been announced but is not in production. Samples may or may not be available.

**OBSOLETE:** TI has discontinued the production of the device.

<sup>(2)</sup> Eco Plan - The planned eco-friendly classification: Pb-Free (RoHS), Pb-Free (RoHS Exempt), or Green (RoHS & no Sb/Br) - please check <http://www.ti.com/productcontent> for the latest availability information and additional product content details.

**TBD:** The Pb-Free/Green conversion plan has not been defined.

**Pb-Free (RoHS):** TI's terms "Lead-Free" or "Pb-Free" mean semiconductor products that are compatible with the current RoHS requirements for all 6 substances, including the requirement that lead not exceed 0.1% by weight in homogeneous materials. Where designed to be soldered at high temperatures, TI Pb-Free products are suitable for use in specified lead-free processes.

**Pb-Free (RoHS Exempt):** This component has a RoHS exemption for either 1) lead-based flip-chip solder bumps used between the die and package, or 2) lead-based die adhesive used between the die and leadframe. The component is otherwise considered Pb-Free (RoHS compatible) as defined above.

**Green (RoHS & no Sb/Br):** TI defines "Green" to mean Pb-Free (RoHS compatible), and free of Bromine (Br) and Antimony (Sb) based flame retardants (Br or Sb do not exceed 0.1% by weight in homogeneous material)

<sup>(3)</sup> MSL, Peak Temp. -- The Moisture Sensitivity Level rating according to the JEDEC industry standard classifications, and peak solder temperature.

**Important Information and Disclaimer:**The information provided on this page represents TI's knowledge and belief as of the date that it is provided. TI bases its knowledge and belief on information provided by third parties, and makes no representation or warranty as to the accuracy of such information. Efforts are underway to better integrate information from third parties. TI has taken and continues to take reasonable steps to provide representative and accurate information but may not have conducted destructive testing or chemical analysis on incoming materials and chemicals. TI and TI suppliers consider certain information to be proprietary, and thus CAS numbers and other limited information may not be available for release.

In no event shall TI's liability arising out of such information exceed the total purchase price of the TI part(s) at issue in this document sold by TI to Customer on an annual basis.

PQ (S-PQFP-G<sup>\*\*\*</sup>)

PLASTIC QUAD FLATPACK

100 LEAD SHOWN

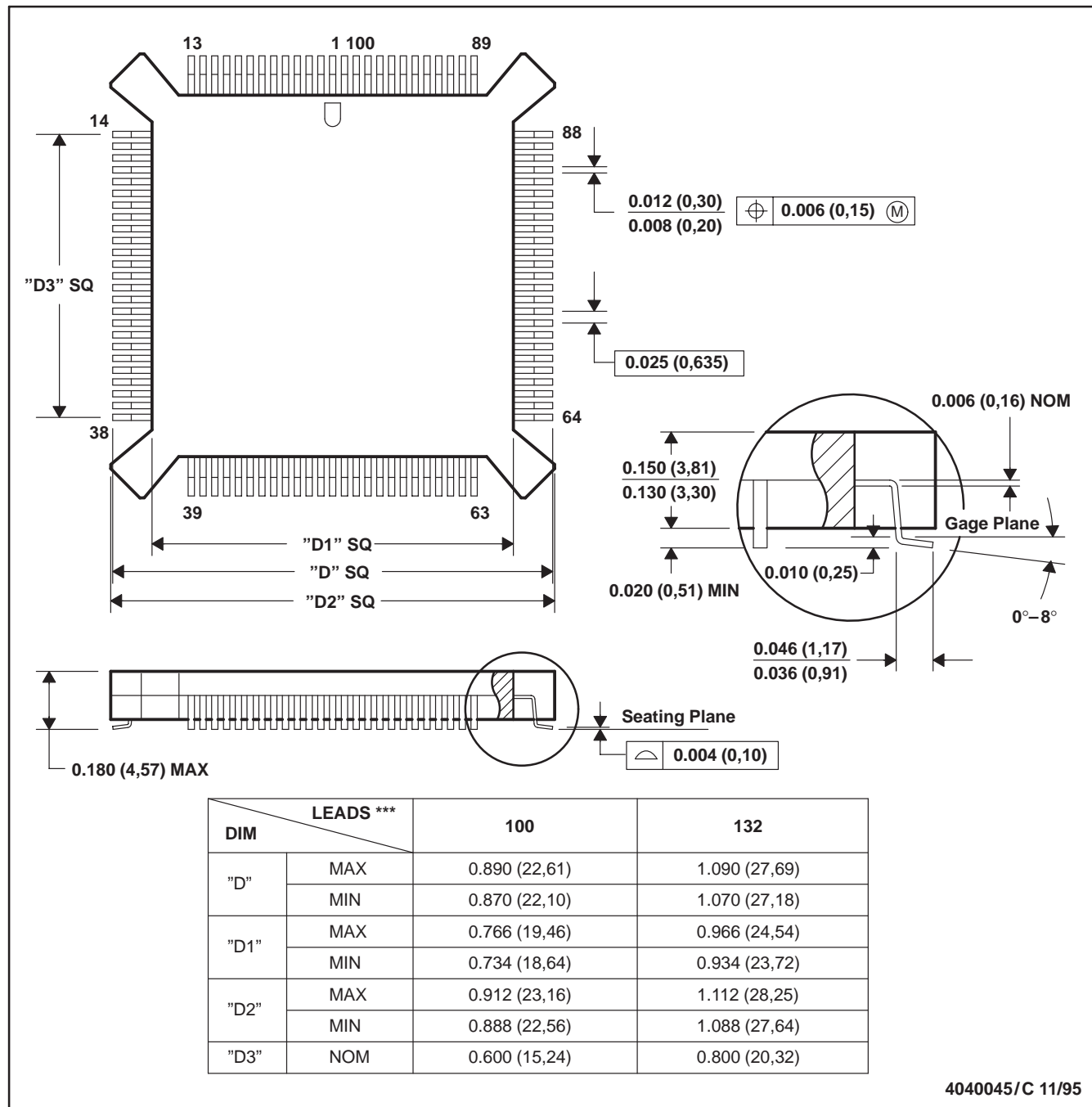

- NOTES: A. All linear dimensions are in inches (millimeters).  
 B. This drawing is subject to change without notice.  
 C. Falls within JEDEC MO-069



PCB (S-PQFP-G120)

PLASTIC QUAD FLATPACK (DIE DOWN)

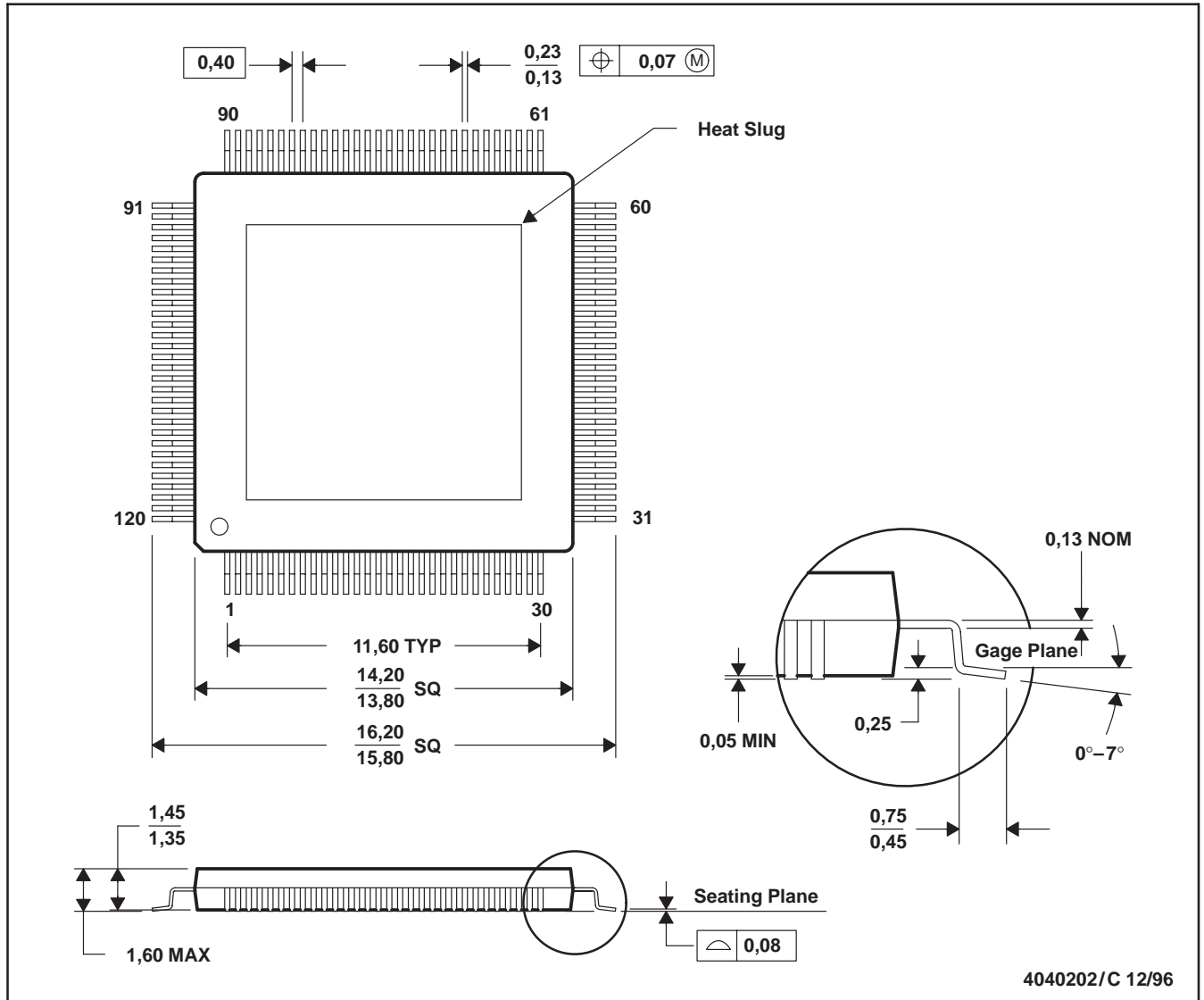

- NOTES: A. All linear dimensions are in millimeters.  
 B. This drawing is subject to change without notice.  
 C. Thermally enhanced molded plastic package with a heat slug (HSL)  
 D. Falls within JEDEC MS-026

## IMPORTANT NOTICE

Texas Instruments Incorporated and its subsidiaries (TI) reserve the right to make corrections, modifications, enhancements, improvements, and other changes to its products and services at any time and to discontinue any product or service without notice. Customers should obtain the latest relevant information before placing orders and should verify that such information is current and complete. All products are sold subject to TI's terms and conditions of sale supplied at the time of order acknowledgment.

TI warrants performance of its hardware products to the specifications applicable at the time of sale in accordance with TI's standard warranty. Testing and other quality control techniques are used to the extent TI deems necessary to support this warranty. Except where mandated by government requirements, testing of all parameters of each product is not necessarily performed.

TI assumes no liability for applications assistance or customer product design. Customers are responsible for their products and applications using TI components. To minimize the risks associated with customer products and applications, customers should provide adequate design and operating safeguards.

TI does not warrant or represent that any license, either express or implied, is granted under any TI patent right, copyright, mask work right, or other TI intellectual property right relating to any combination, machine, or process in which TI products or services are used. Information published by TI regarding third-party products or services does not constitute a license from TI to use such products or services or a warranty or endorsement thereof. Use of such information may require a license from a third party under the patents or other intellectual property of the third party, or a license from TI under the patents or other intellectual property of TI.

Reproduction of TI information in TI data books or data sheets is permissible only if reproduction is without alteration and is accompanied by all associated warranties, conditions, limitations, and notices. Reproduction of this information with alteration is an unfair and deceptive business practice. TI is not responsible or liable for such altered documentation. Information of third parties may be subject to additional restrictions.

Resale of TI products or services with statements different from or beyond the parameters stated by TI for that product or service voids all express and any implied warranties for the associated TI product or service and is an unfair and deceptive business practice. TI is not responsible or liable for any such statements.

TI products are not authorized for use in safety-critical applications (such as life support) where a failure of the TI product would reasonably be expected to cause severe personal injury or death, unless officers of the parties have executed an agreement specifically governing such use. Buyers represent that they have all necessary expertise in the safety and regulatory ramifications of their applications, and acknowledge and agree that they are solely responsible for all legal, regulatory and safety-related requirements concerning their products and any use of TI products in such safety-critical applications, notwithstanding any applications-related information or support that may be provided by TI. Further, Buyers must fully indemnify TI and its representatives against any damages arising out of the use of TI products in such safety-critical applications.

TI products are neither designed nor intended for use in military/aerospace applications or environments unless the TI products are specifically designated by TI as military-grade or "enhanced plastic." Only products designated by TI as military-grade meet military specifications. Buyers acknowledge and agree that any such use of TI products which TI has not designated as military-grade is solely at the Buyer's risk, and that they are solely responsible for compliance with all legal and regulatory requirements in connection with such use.

TI products are neither designed nor intended for use in automotive applications or environments unless the specific TI products are designated by TI as compliant with ISO/TS 16949 requirements. Buyers acknowledge and agree that, if they use any non-designated products in automotive applications, TI will not be responsible for any failure to meet such requirements.

Following are URLs where you can obtain information on other Texas Instruments products and application solutions:

### Products

Amplifiers	<a href="http://amplifier.ti.com">amplifier.ti.com</a>
Data Converters	<a href="http://dataconverter.ti.com">dataconverter.ti.com</a>
DLP® Products	<a href="http://www.dlp.com">www.dlp.com</a>
DSP	<a href="http://dsp.ti.com">dsp.ti.com</a>
Clocks and Timers	<a href="http://www.ti.com/clocks">www.ti.com/clocks</a>
Interface	<a href="http://interface.ti.com">interface.ti.com</a>
Logic	<a href="http://logic.ti.com">logic.ti.com</a>
Power Mgmt	<a href="http://power.ti.com">power.ti.com</a>
Microcontrollers	<a href="http://microcontroller.ti.com">microcontroller.ti.com</a>
RFID	<a href="http://www.ti-rfid.com">www.ti-rfid.com</a>
RF/IF and ZigBee® Solutions	<a href="http://www.ti.com/lprf">www.ti.com/lprf</a>

### Applications

Audio	<a href="http://www.ti.com/audio">www.ti.com/audio</a>
Automotive	<a href="http://www.ti.com/automotive">www.ti.com/automotive</a>
Broadband	<a href="http://www.ti.com/broadband">www.ti.com/broadband</a>
Digital Control	<a href="http://www.ti.com/digitalcontrol">www.ti.com/digitalcontrol</a>
Medical	<a href="http://www.ti.com/medical">www.ti.com/medical</a>
Military	<a href="http://www.ti.com/military">www.ti.com/military</a>
Optical Networking	<a href="http://www.ti.com/opticalnetwork">www.ti.com/opticalnetwork</a>
Security	<a href="http://www.ti.com/security">www.ti.com/security</a>
Telephony	<a href="http://www.ti.com/telephony">www.ti.com/telephony</a>
Video & Imaging	<a href="http://www.ti.com/video">www.ti.com/video</a>
Wireless	<a href="http://www.ti.com/wireless">www.ti.com/wireless</a>

Mailing Address: Texas Instruments, Post Office Box 655303, Dallas, Texas 75265  
Copyright © 2009, Texas Instruments Incorporated

[www.BDTIC.com/TI](http://www.BDTIC.com/TI)