

POWER-DISTRIBUTION SWITCHES

FEATURES

- 33-mΩ (5-V Input) High-Side MOSFET Switch
- Short-Circuit and Thermal Protection
- Overcurrent Logic Output
- Operating Range . . . 2.7 V to 5.5 V
- Logic-Level Enable Input
- Typical Rise Time . . . 6.1 ms
- Undervoltage Lockout
- Maximum Standby Supply Current . . . 10 μA
- No Drain-Source Back-Gate Diode
- Available in 8-Pin SOIC and PDIP Packages
- Ambient Temperature Range, –40°C to 85°C
- 2-kV Human-Body-Model, 200-V Machine-Model ESD Protection

- UL Listed - File No. E169910

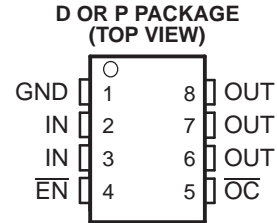

DESCRIPTION

The TPS202x family of power distribution switches is intended for applications where heavy capacitive loads and short circuits are likely to be encountered. These devices are 50-mΩ N-channel MOSFET high-side power switches. The switch is controlled by a logic enable compatible with 5-V logic and 3-V logic. Gate drive is provided by an internal charge pump designed to control the power-switch rise times and fall times to minimize current surges during switching. The charge pump requires no external components and allows operation from supplies as low as 2.7 V.

When the output load exceeds the current-limit threshold or a short is present, the TPS202x limits the output current to a safe level by switching into a constant-current mode, pulling the overcurrent (\overline{OC}) logic output low. When continuous heavy overloads and short circuits increase the power dissipation in the switch, causing the junction temperature to rise, a thermal protection circuit shuts off the switch to prevent damage. Recovery from a thermal shutdown is automatic once the device has cooled sufficiently. Internal circuitry ensures the switch remains off until valid input voltage is present.

The TPS202x devices differ only in short-circuit current threshold. The TPS2020 limits at 0.3-A load, the TPS2021 at 0.9-A load, the TPS2022 at 1.5-A load, the TPS2023 at 2.2-A load, and the TPS2024 at 3-A load (see [Available Options](#)). The TPS202x is available in an 8-pin small-outline integrated-circuit (SOIC) package and in an 8-pin dual in-line package (DIP) and operates over a junction temperature range of –40°C to 125°C.

GENERAL SWITCH CATALOG						
33 mΩ, Single	80 mΩ, Single	80 mΩ, Dual	80 mΩ, Dual	80 mΩ, Triple	80 mΩ, Quad	80 mΩ, Quad
TPS201xA 0.2 A to 2 A TPS202x 0.2 A to 2 A TPS203x 0.2 A to 2 A	TPS2014 600 mA TPS2015 1 A TPS2041B 500 mA TPS2051B 500 mA TPS2045A 250 mA TPS2049 100 mA TPS2055A 250 mA TPS2061 1 A TPS2065 1 A TPS2068 1.5 A TPS2069 1.5 A	TPS2042B 500 mA TPS2052B 500 mA TPS2046B 250 mA TPS2056 250 mA TPS2062 1 A TPS2066 1 A TPS2060 1.5 A TPS2064 1.5 A	TPS2080 500 mA TPS2081 500 mA TPS2082 500 mA TPS2090 250 mA TPS2091 250 mA TPS2092 250 mA	TPS2043B 500 mA TPS2053B 500 mA TPS2047B 250 mA TPS2057A 250 mA TPS2063 1 A TPS2067 1 A	TPS2044B 500 mA TPS2054B 500 mA TPS2048A 250 mA TPS2058 250 mA	TPS2085 500 mA TPS2086 500 mA TPS2087 500 mA TPS2095 250 mA TPS2096 250 mA TPS2097 250 mA



Please be aware that an important notice concerning availability, standard warranty, and use in critical applications of Texas Instruments semiconductor products and disclaimers thereto appears at the end of this data sheet.

Table 1. AVAILABLE OPTIONS

T _A	ENABLE	RECOMMENDED MAXIMUM CONTINUOUS LOAD CURRENT (A)	TYPICAL SHORT-CIRCUIT CURRENT LIMIT AT 25°C (A)	PACKAGED DEVICES	
				SMALL OUTLINE (D) ⁽¹⁾	PLASTIC DIP (P)
–40°C to 85°C	Active low	0.2	0.3	TPS2020D	TPS2020P
		0.6	0.9	TPS2021D	TPS2021P
		1	1.5	TPS2022D	TPS2022P
		1.5	2.2	TPS2023D	TPS2023P
		2	3	TPS2024D	TPS2024P

(1) The D package is available taped and reeled. Add an R suffix to device type (e.g., TPS2020DR)

TPS2020 FUNCTIONAL BLOCK DIAGRAM

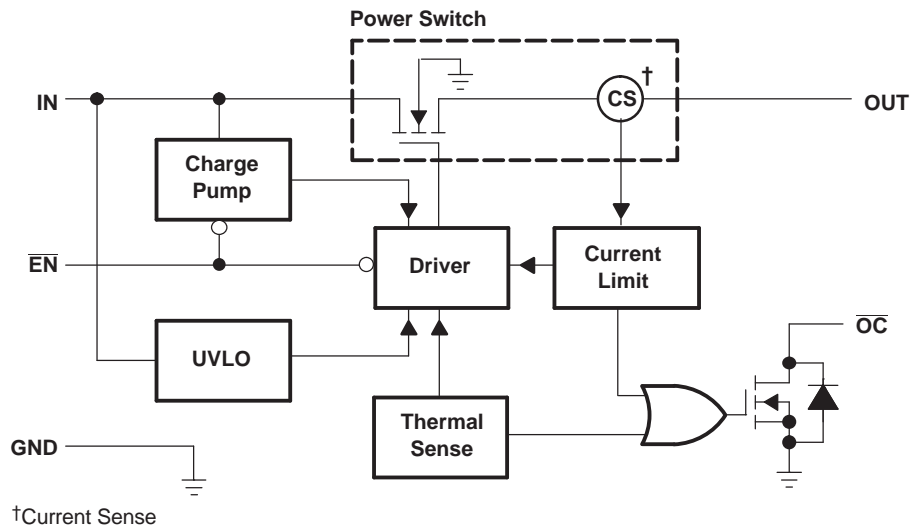

TERMINAL FUNCTIONS

TERMINAL		I/O	DESCRIPTION
NAME	NO. D OR P		
$\overline{\text{EN}}$	4	I	Enable input. Logic-low turns on power switch.
GND	1	I	Ground
IN	2, 3	I	Input voltage
$\overline{\text{OC}}$	5	O	Overcurrent. Logic output, active-low
OUT	6, 7, 8	O	Power-switch output

DETAILED DESCRIPTION

POWER SWITCH

The power switch is an N-channel MOSFET with a maximum on-state resistance of 50 m Ω ($V_{I(IN)} = 5$ V). Configured as a high-side switch, the power switch prevents current flow from OUT to IN and IN to OUT when disabled.

CHARGE PUMP

An internal charge pump supplies power to the driver circuit and provides the necessary voltage to pull the gate of the MOSFET above the source. The charge pump operates from input voltages as low as 2.7 V and requires very little supply current.

DRIVER

The driver controls the gate voltage of the power switch. To limit large current surges and reduce the associated electromagnetic interference (EMI) produced, the driver incorporates circuitry that controls the rise times and fall times of the output voltage. The rise and fall times are typically in the 2-ms to 9-ms range.

ENABLE (\overline{EN})

The logic enable disables the power switch, the bias for the charge pump, driver, and other circuitry to reduce the supply current to less than 10 μ A when a logic-high is present on \overline{EN} . A logic-zero input on \overline{EN} restores bias to the drive and control circuits and turns the power on. The enable input is compatible with both TTL and CMOS logic levels.

OVERCURRENT (\overline{OC})

The \overline{OC} open drain output is asserted (active low) when an overcurrent or overtemperature condition is encountered. The output remains asserted until the overcurrent or overtemperature condition is removed.

CURRENT SENSE

A sense FET monitors the current supplied to the load. The sense FET measures current more efficiently than conventional resistance methods. When an overload or short circuit is encountered, the current-sense circuitry sends a control signal to the driver. The driver, in turn, reduces the gate voltage and drives the power FET into its saturation region, which switches the output into a constant-current mode and holds the current constant while varying the voltage on the load.

THERMAL SENSE

An internal thermal-sense circuit shuts off the power switch when the junction temperature rises to approximately 140°C. Hysteresis is built into the thermal sense circuit. After the device has cooled approximately 20°C, the switch turns back on. The switch continues to cycle off and on until the fault is removed.

UNDERVOLTAGE LOCKOUT

A voltage sense circuit monitors the input voltage. When the input voltage is below approximately 2 V, a control signal turns off the power switch.

ABSOLUTE MAXIMUM RATINGS

over operating free-air temperature range (unless otherwise noted)⁽¹⁾

$V_{I(IN)}$ ⁽²⁾	Input voltage range	–0.3 V to 6 V
$V_{O(OUT)}$ ⁽²⁾	Output voltage range	–0.3 V to $V_{I(IN)} + 0.3$ V
$V_{I(EN)}$	Input voltage range	–0.3 V to 6 V
$I_{O(OUT)}$	Continuous output current	Internally limited
	Continuous total power dissipation	See Dissipation Rating Table
T_J	Operating virtual junction temperature range	–40°C to 125°C
T_{stg}	Storage temperature range	–65°C to 150°C
	Lead temperature soldering 1,6 mm (1/16 inch) from case for 10 seconds	260°C
	Electrostatic discharge (ESD) protection:	
	Human body model	2 kV
	Machine model	200 V
	Charged device model (CDM)	750 V

- (1) Stresses beyond those listed under absolute maximum ratings may cause permanent damage to the device. These are stress ratings only, and functional operation of the device at these or any other conditions beyond those indicated under recommended operating conditions is not implied. Exposure to absolute-maximum-rated conditions for extended periods may affect device reliability.
- (2) All voltages are with respect to GND.

DISSIPATION RATING TABLE

PACKAGE	$T_A \leq 25^\circ\text{C}$ POWER RATING	DERATING FACTOR ABOVE $T_A = 25^\circ\text{C}$	$T_A = 70^\circ\text{C}$ POWER RATING	$T_A = 85^\circ\text{C}$ POWER RATING
D	725 mW	5.8 mW/°C	464 mW	377 mW
P	1175 mW	9.4 mW/°C	752 mW	611 mW

RECOMMENDED OPERATING CONDITIONS

		MIN	MAX	UNIT	
$V_{I(IN)}$	Input voltage	2.7	5.5	V	
$V_{I(EN)}$		0	5.5	V	
I_O	Continuous output current	TPS2020	0	0.2	A
		TPS2021	0	0.6	
		TPS2022	0	1	
		TPS2023	0	1.5	
		TPS2024	0	2	
T_J	Operating virtual junction temperature	–40	125	°C	

ELECTRICAL CHARACTERISTICS

over recommended operating junction temperature range, $V_{I(IN)} = 5.5\text{ V}$, $I_O = \text{rated current}$, $\overline{EN} = 0\text{ V}$ (unless otherwise noted)

PARAMETER		TEST CONDITIONS ⁽¹⁾		MIN	TYP	MAX	UNIT
POWER SWITCH							
$r_{DS(on)}$	Static drain-source on-state resistance	$V_{I(IN)} = 5\text{ V}$, $T_J = 25^\circ\text{C}$, $I_O = 1.8\text{ A}$		33	36		mΩ
		$V_{I(IN)} = 5\text{ V}$, $T_J = 85^\circ\text{C}$, $I_O = 1.8\text{ A}$		38	46		
		$V_{I(IN)} = 5\text{ V}$, $T_J = 125^\circ\text{C}$, $I_O = 1.8\text{ A}$		44	50		
		$V_{I(IN)} = 3.3\text{ V}$, $T_J = 25^\circ\text{C}$, $I_O = 1.8\text{ A}$		37	41		
		$V_{I(IN)} = 3.3\text{ V}$, $T_J = 85^\circ\text{C}$, $I_O = 1.8\text{ A}$		43	52		
		$V_{I(IN)} = 3.3\text{ V}$, $T_J = 125^\circ\text{C}$, $I_O = 1.8\text{ A}$		51	61		
		$V_{I(IN)} = 5\text{ V}$, $T_J = 25^\circ\text{C}$, $I_O = 0.18\text{ A}$		30	34		
		$V_{I(IN)} = 5\text{ V}$, $T_J = 85^\circ\text{C}$, $I_O = 0.18\text{ A}$		35	41		
		$V_{I(IN)} = 5\text{ V}$, $T_J = 125^\circ\text{C}$, $I_O = 0.18\text{ A}$		39	47		
		$V_{I(IN)} = 3.3\text{ V}$, $T_J = 25^\circ\text{C}$, $I_O = 0.18\text{ A}$		33	37		
		$V_{I(IN)} = 3.3\text{ V}$, $T_J = 85^\circ\text{C}$, $I_O = 0.18\text{ A}$		39	46		
		$V_{I(IN)} = 3.3\text{ V}$, $T_J = 125^\circ\text{C}$, $I_O = 0.18\text{ A}$		44	56		
t_r	Rise time, output	$V_{I(IN)} = 5.5\text{ V}$, $C_L = 1\text{ }\mu\text{F}$, $T_J = 25^\circ\text{C}$, $R_L = 10\text{ }\Omega$		6.1			ms
		$V_{I(IN)} = 2.7\text{ V}$, $C_L = 1\text{ }\mu\text{F}$, $T_J = 25^\circ\text{C}$, $R_L = 10\text{ }\Omega$		8.6			
t_f	Fall time, output	$V_{I(IN)} = 5.5\text{ V}$, $C_L = 1\text{ }\mu\text{F}$, $T_J = 25^\circ\text{C}$, $R_L = 10\text{ }\Omega$		3.4			ms
		$V_{I(IN)} = 2.7\text{ V}$, $C_L = 1\text{ }\mu\text{F}$, $T_J = 25^\circ\text{C}$, $R_L = 10\text{ }\Omega$		3			
ENABLE INPUT (\overline{EN})							
V_{IH}	High-level input voltage	$2.7\text{ V} \leq V_{I(IN)} \leq 5.5\text{ V}$		2			V
V_{IL}	Low-level input voltage	$4.5\text{ V} \leq V_{I(IN)} \leq 5.5\text{ V}$				0.8	V
		$2.7\text{ V} \leq V_{I(IN)} \leq 4.5\text{ V}$				0.5	
I_I	Input current	$\overline{EN} = 0\text{ V}$ or $\overline{EN} = V_{I(IN)}$		-0.5		0.5	μA
t_{on}	Turnon time	$C_L = 100\text{ }\mu\text{F}$, $R_L = 10\text{ }\Omega$				20	ms
t_{off}	Turnoff time	$C_L = 100\text{ }\mu\text{F}$, $R_L = 10\text{ }\Omega$				40	
CURRENT LIMIT							
I_{OS}	Short-circuit output current	$T_J = 25^\circ\text{C}$, $V_I = 5.5\text{ V}$, OUT connected to GND, Device enabled into short circuit	TPS2020	0.22	0.3	0.4	A
			TPS2021	0.66	0.9	1.1	
			TPS2022	1.1	1.5	1.8	
			TPS2023	1.65	2.2	2.7	
			TPS2024	2.2	3	3.8	
SUPPLY CURRENT							
Supply current, low-level output	No load on OUT	$\overline{EN} = V_{I(IN)}$	$T_J = 25^\circ\text{C}$	0.3	1	μA	
			$-40^\circ\text{C} \leq T_J \leq 125^\circ\text{C}$		10		
Supply current, high-level output	No load on OUT	$\overline{EN} = 0\text{ V}$	$T_J = 25^\circ\text{C}$	58	75	μA	
			$-40^\circ\text{C} \leq T_J \leq 125^\circ\text{C}$	75	100		
Leakage current	OUT connected to ground	$\overline{EN} = V_{I(IN)}$	$-40^\circ\text{C} \leq T_J \leq 125^\circ\text{C}$	10		μA	
UNDERVOLTAGE LOCKOUT							
Low-level input voltage				2		2.5	V
Hysteresis			$T_J = 25^\circ\text{C}$		100		mV
OVERCURRENT (\overline{OC})							
Output low voltage			$I_O = 10\text{ mA}$, $V_{OL(OC)}$			0.4	V
Off-state current ⁽²⁾			$V_O = 5\text{ V}$, $V_O = 3.3\text{ V}$			1	μA

(1) Pulse-testing techniques maintain junction temperature close to ambient temperature; thermal effects must be taken into account separately.

(2) Specified by design, not production tested.

PARAMETER MEASUREMENT INFORMATION

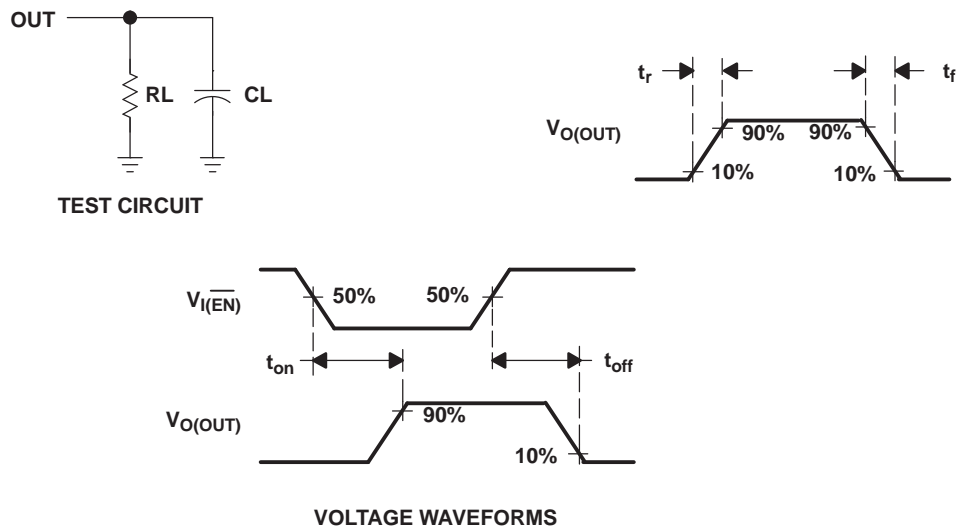

Figure 1. Test Circuit and Voltage Waveforms

PARAMETER MEASUREMENT INFORMATION (continued)

TABLE OF TIMING DIAGRAMS

	FIGURE
Turnon Delay and Rise Time	2
Turnoff Delay and Fall Time	3
Turnon Delay and Rise Time with 1- μ F Load	4
Turnoff Delay and Rise Time with 1- μ F Load	5
Device Enabled into Short	6
TPS2020, TPS2021, TPS2022, TPS2023, and TPS2024, Ramped Load on Enabled Device	7, 8, 9, 10, 11
TPS2024, Inrush Current	12
7.9- Ω Load Connected to an Enabled TPS2020 Device	13
3.7- Ω Load Connected to an Enabled TPS2020 Device	14
3.7- Ω Load Connected to an Enabled TPS2021 Device	15
2.6- Ω Load Connected to an Enabled TPS2021 Device	16
2.6- Ω Load Connected to an Enabled TPS2022 Device	17
1.2- Ω Load Connected to an Enabled TPS2022 Device	18
1.2- Ω Load Connected to an Enabled TPS2023 Device	19
0.9- Ω Load Connected to an Enabled TPS2023 Device	20
0.9- Ω Load Connected to an Enabled TPS2024 Device	21
0.5- Ω Load Connected to an Enabled TPS2024 Device	22

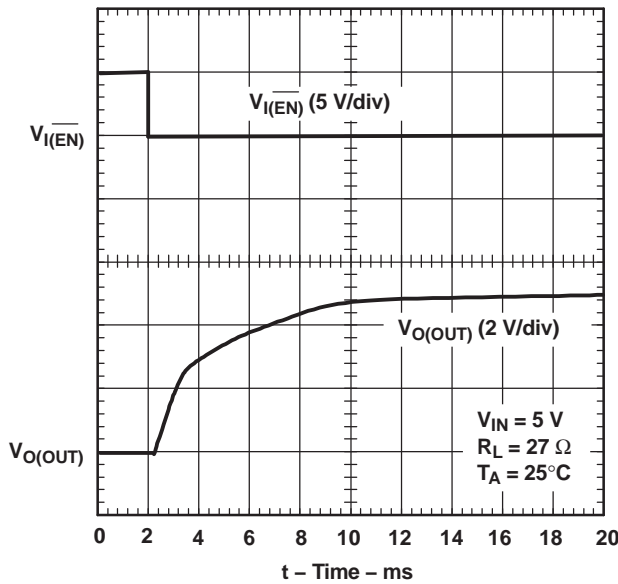

Figure 2. Turnon Delay and Rise Time

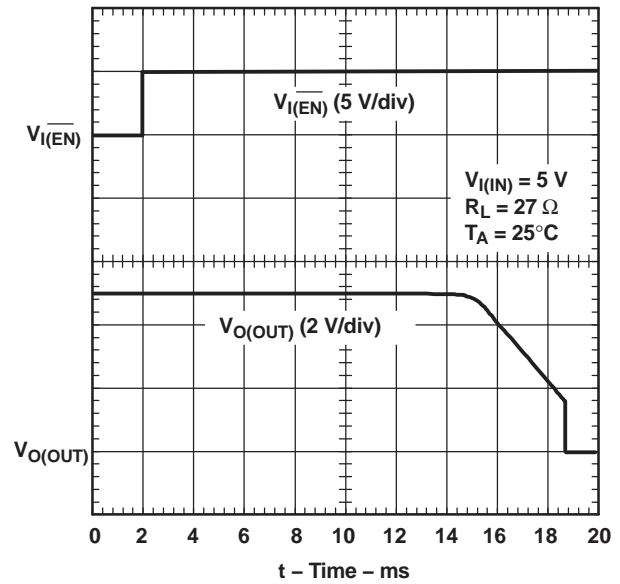

Figure 3. Turnoff Delay and Fall Time

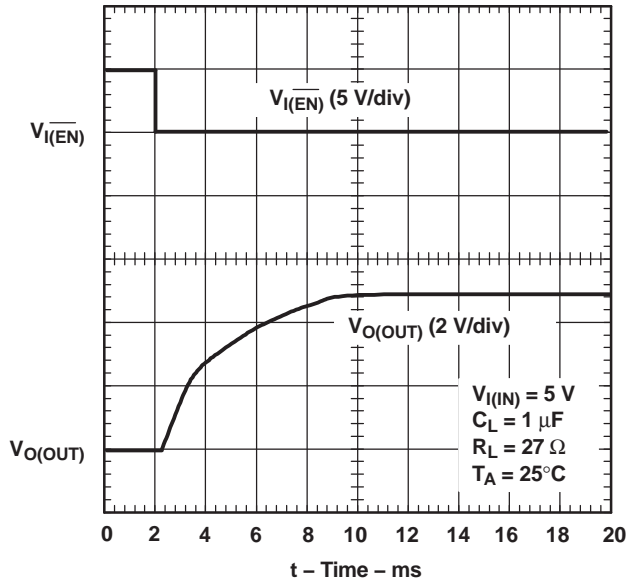

Figure 4. Turnon Delay and Rise Time with 1-µF Load

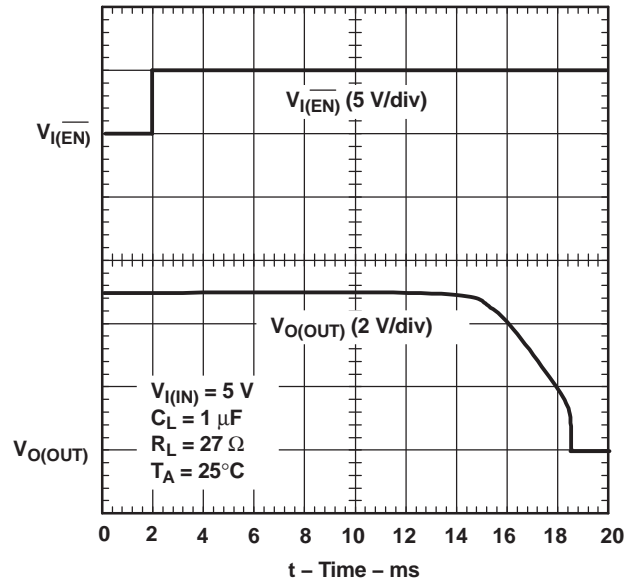

Figure 5. Turnoff Delay and Fall Time with 1-µF Load

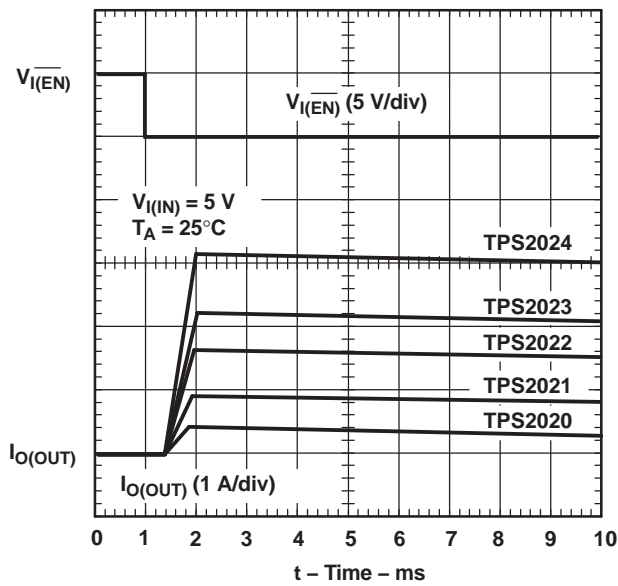

Figure 6. Device Enabled Into Short

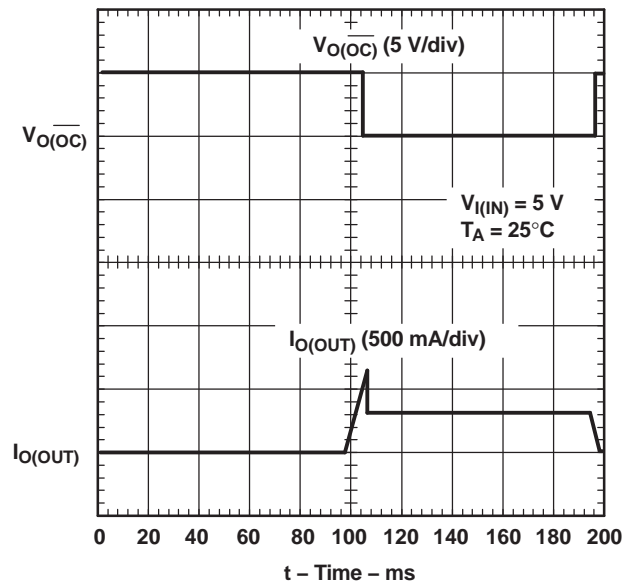

Figure 7. TPS2020, Ramped Load on Enabled Device

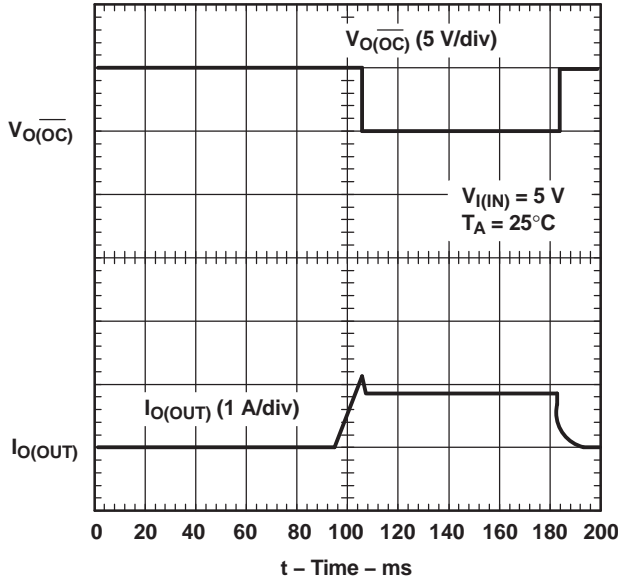

Figure 8. TPS2021, Ramped Load on Enabled Device

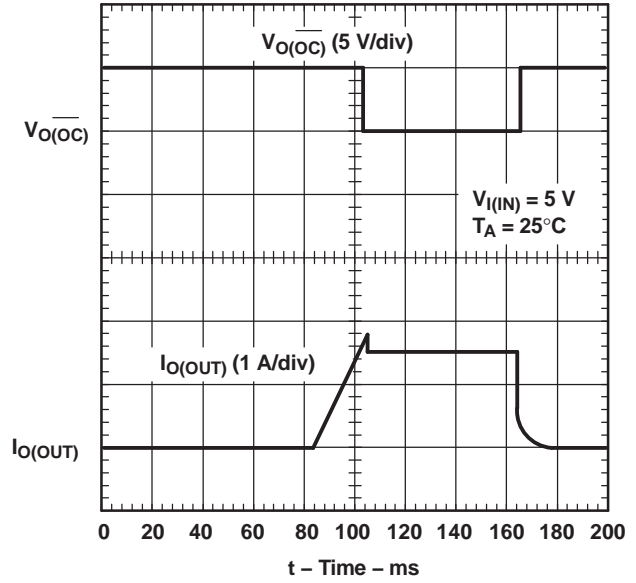

Figure 9. TPS2022, Ramped Load on Enabled Device

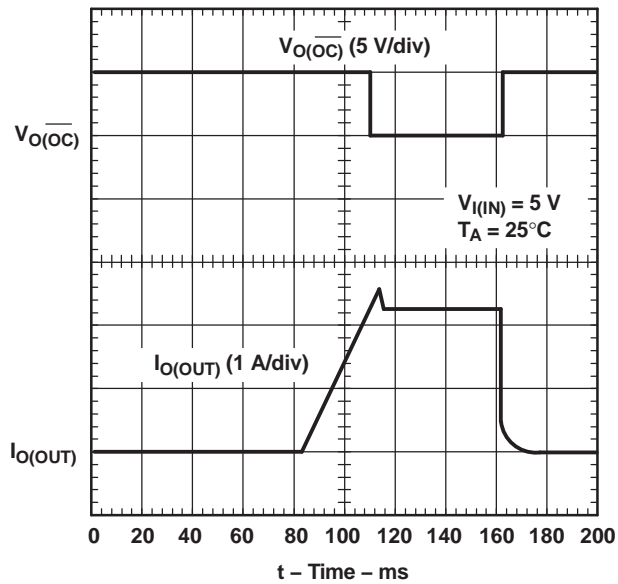

Figure 10. TPS2023, Ramped Load on Enabled Device

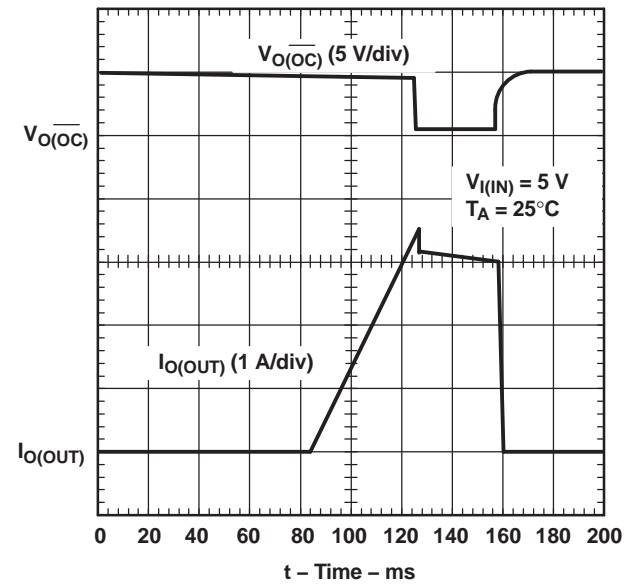

Figure 11. TPS2024, Ramped Load on Enabled Device

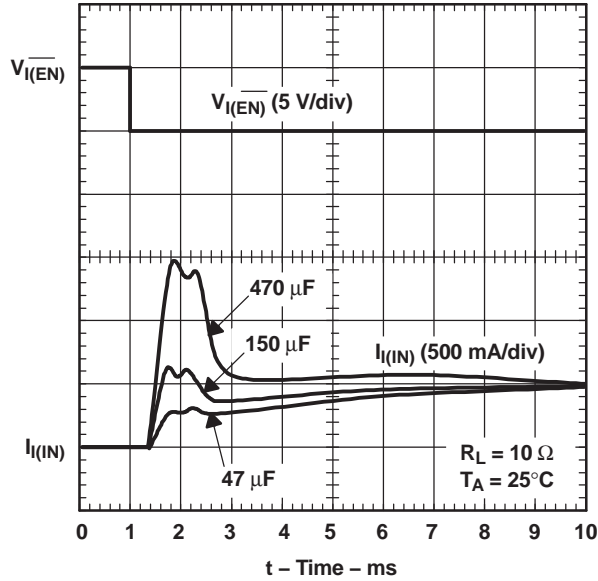

Figure 12. TPS2024, Inrush Current

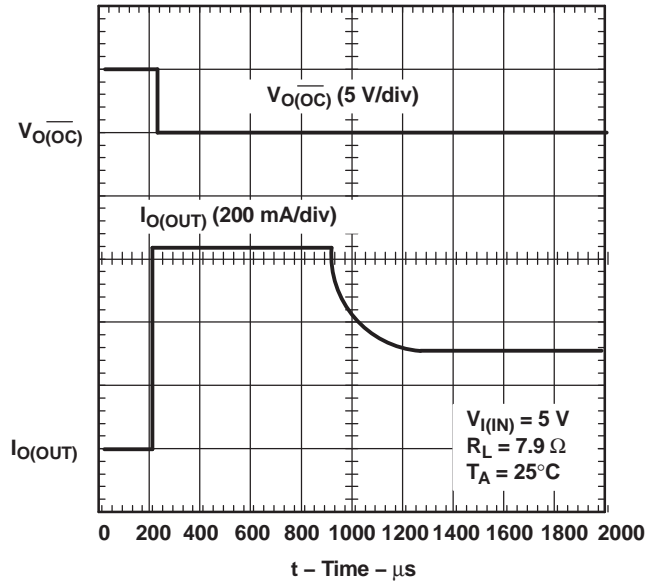

Figure 13. 7.9-Ω Load Connected to an Enabled TPS2020 Device

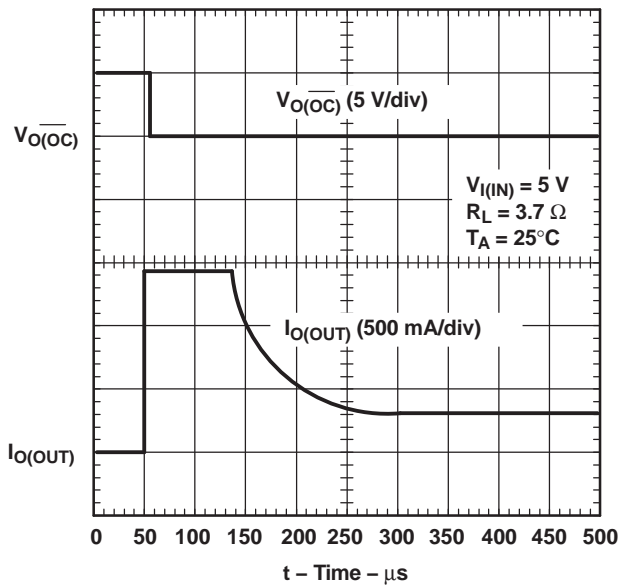

Figure 14. 3.7-Ω Load Connected to an Enabled TPS2020 Device

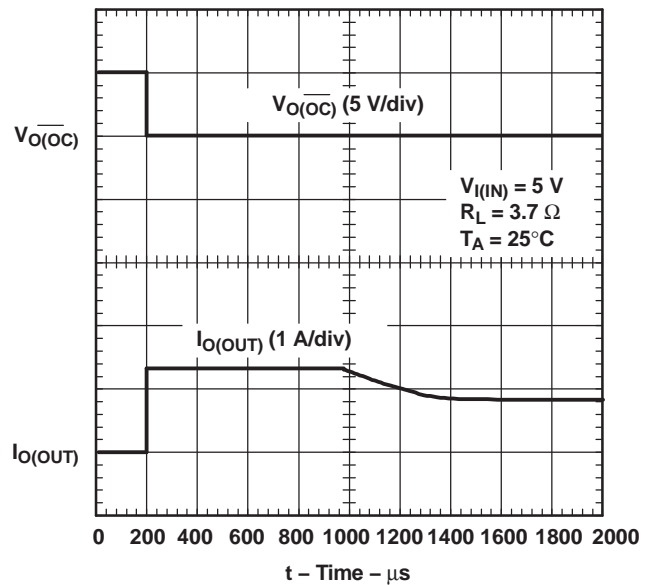

Figure 15. 3.7-Ω Load Connected to an Enabled TPS2021 Device

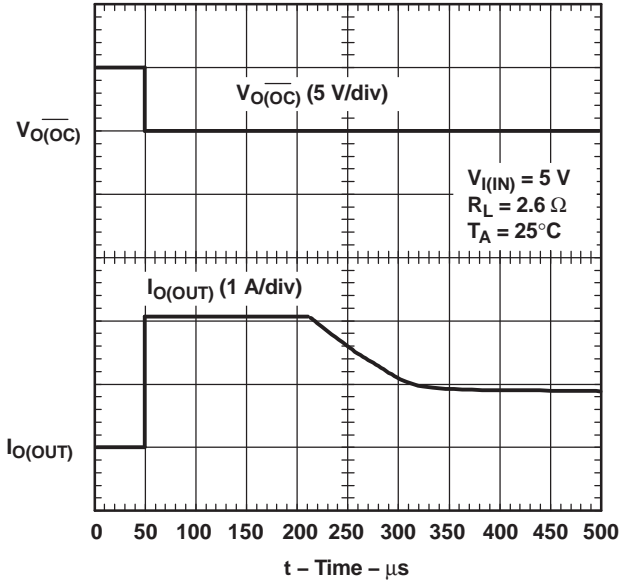

Figure 16. 2.6- Ω Load Connected to an Enabled TPS2021 Device

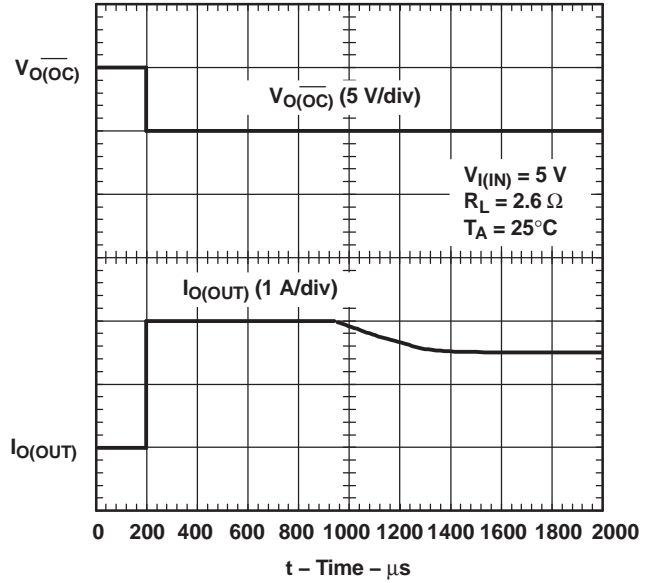

Figure 17. 2.6- Ω Load Connected to an Enabled TPS2022 Device

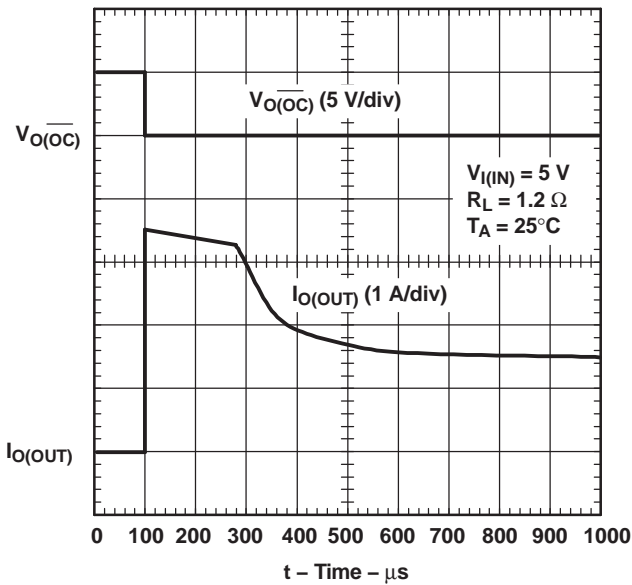

Figure 18. 1.2- Ω Load Connected to an Enabled TPS2022 Device

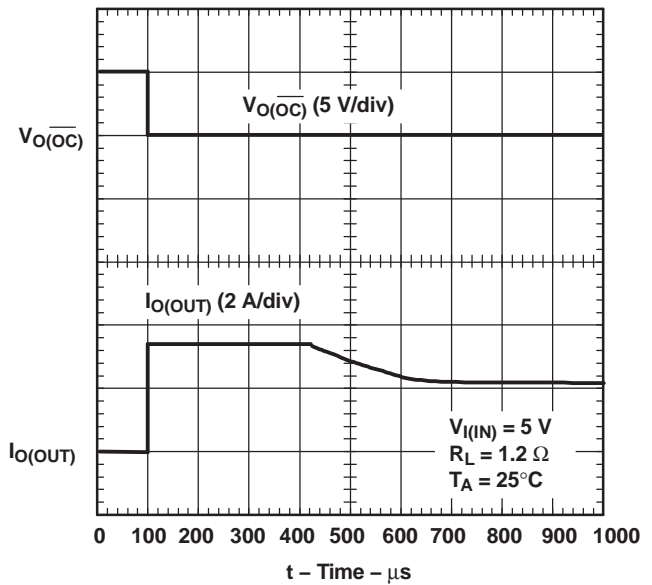

Figure 19. 1.2- Ω Load Connected to an Enabled TPS2023 Device

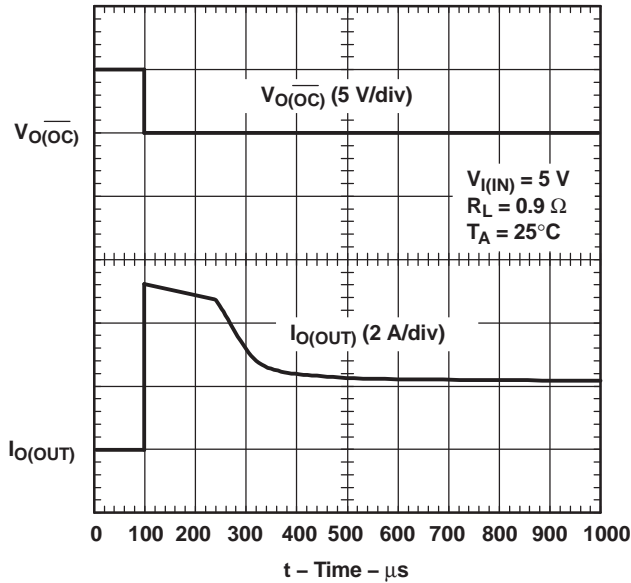

Figure 20. 0.9- Ω Load Connected to an Enabled TPS2023 Device

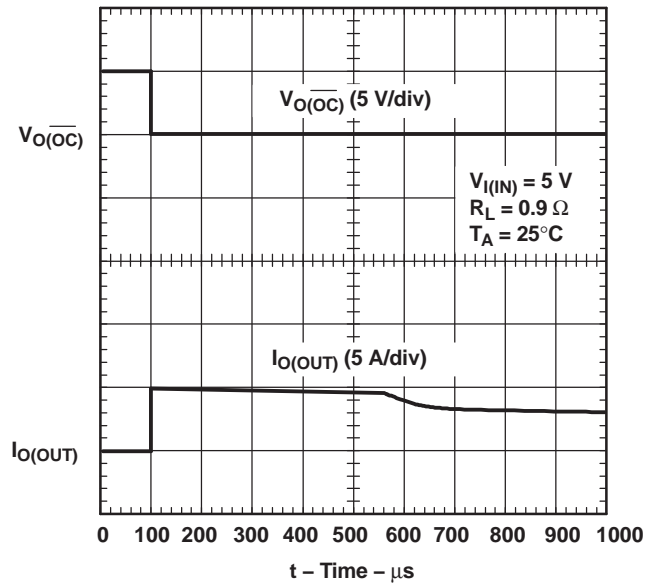

Figure 21. 0.9- Ω Load Connected to an Enabled TPS2024 Device

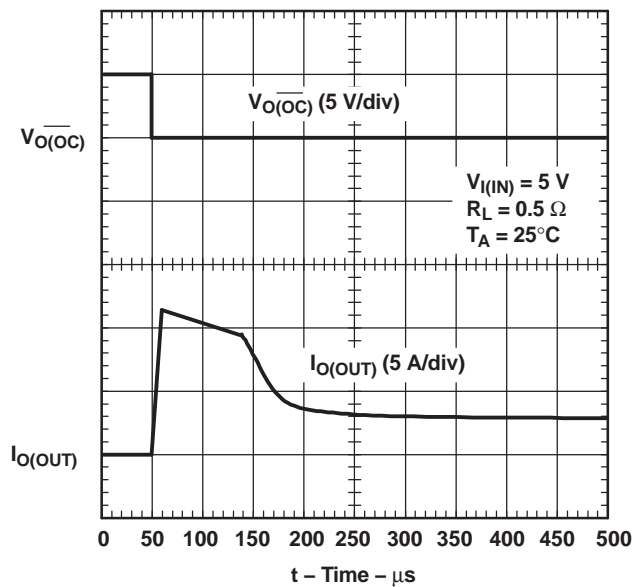

Figure 22. 0.5- Ω Load Connected to an Enabled TPS2024 Device

TYPICAL CHARACTERISTICS

TABLE OF GRAPHS

			FIGURE
$t_{d(on)}$	Turnon delay time	vs Output voltage	23
$t_{d(off)}$	Turnoff delay time	vs Input voltage	24
t_r	Rise time	vs Load current	25
t_f	Fall time	vs Load current	26
	Supply current (enabled)	vs Junction temperature	27
	Supply current (disabled)	vs Junction temperature	28
	Supply current (enabled)	vs Input voltage	29
	Supply current (disabled)	vs Input voltage	30
I_{OS}	Short-circuit current limit	vs Input voltage	31
		vs Junction temperature	32
$r_{DS(on)}$	Static drain-source on-state resistance	vs Input voltage	33
		vs Junction temperature	34
		vs Input voltage	35
		vs Junction temperature	36
V_I	Input voltage	Undervoltage lockout	37

TURNON DELAY TIME
vs
OUTPUT VOLTAGE

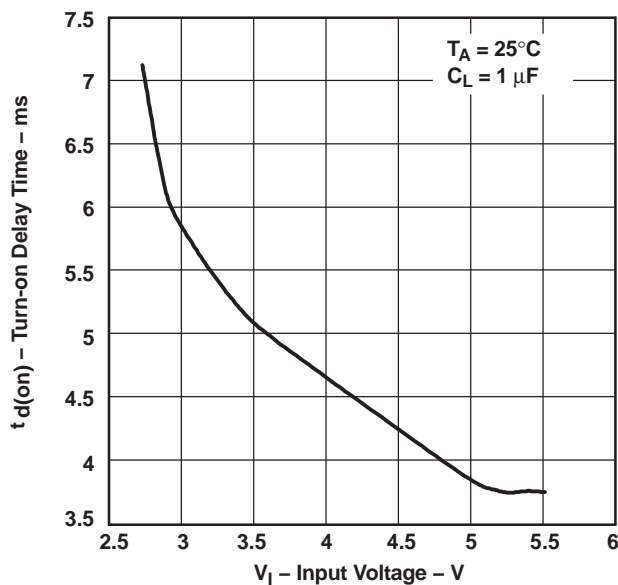

Figure 23.

TURNOFF DELAY TIME
vs
INPUT VOLTAGE

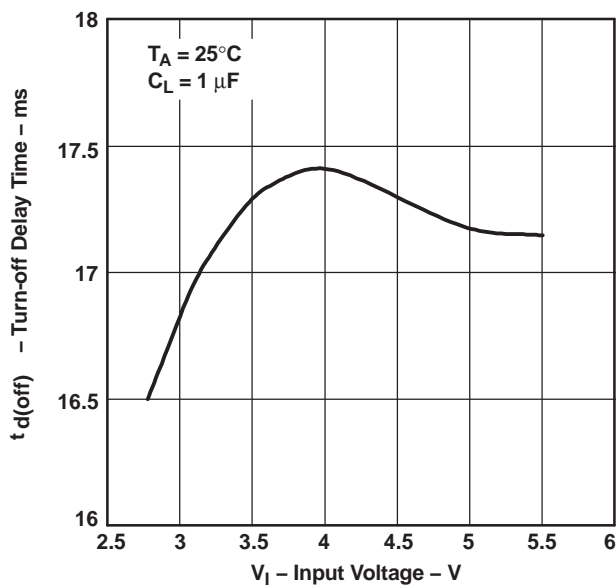

Figure 24.

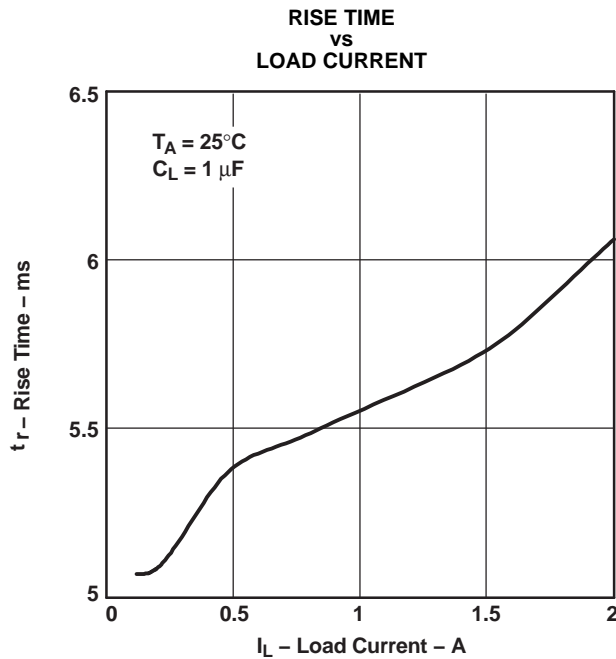

Figure 25.

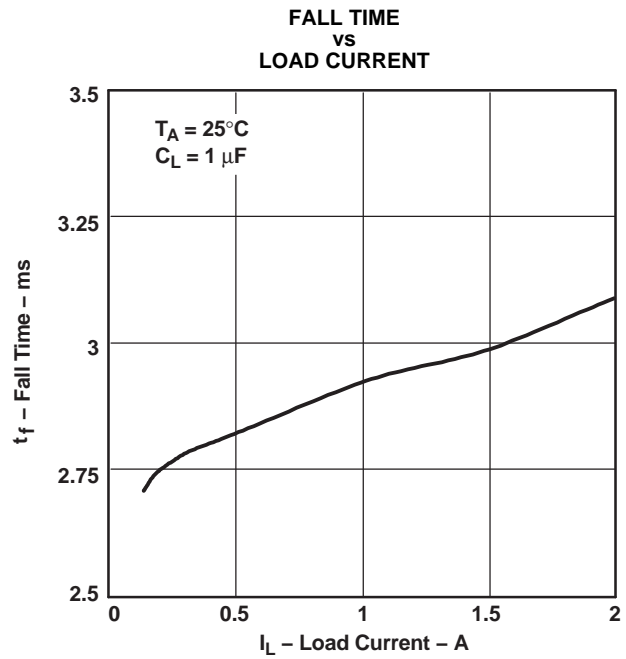

Figure 26.

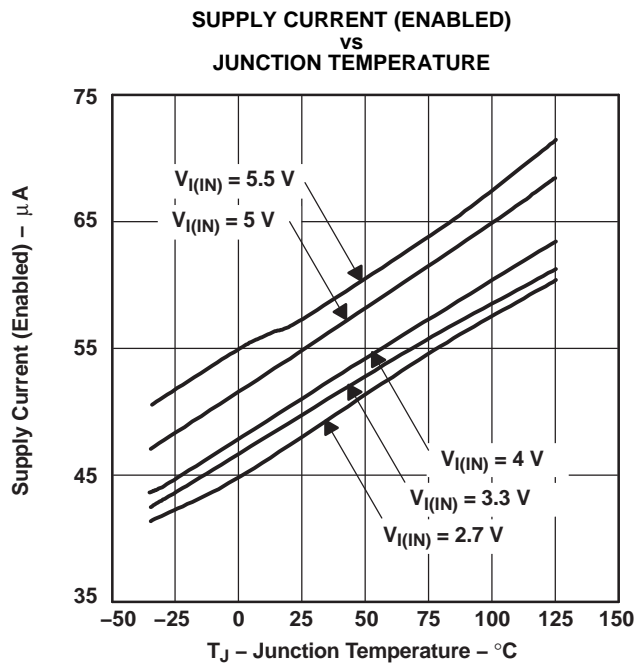

Figure 27.

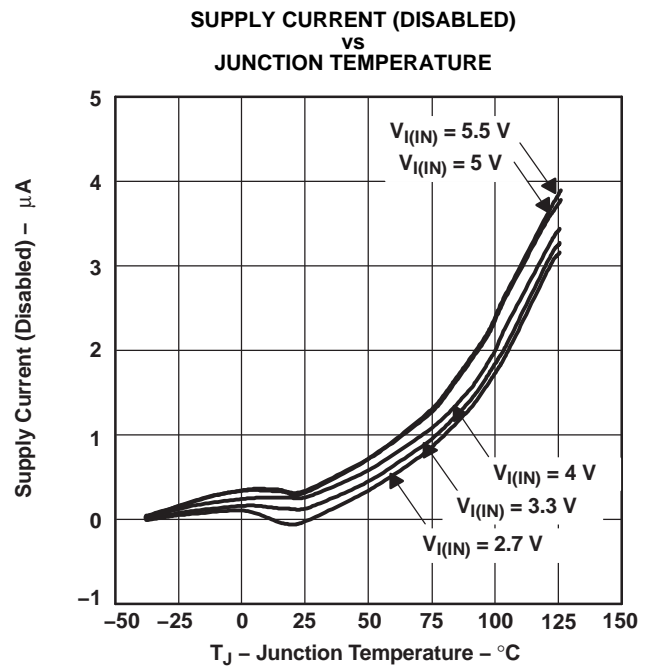

Figure 28.

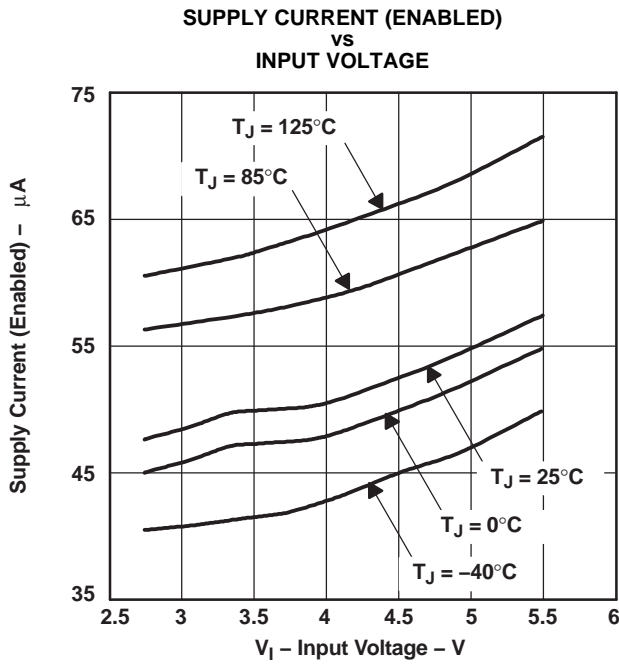

Figure 29.

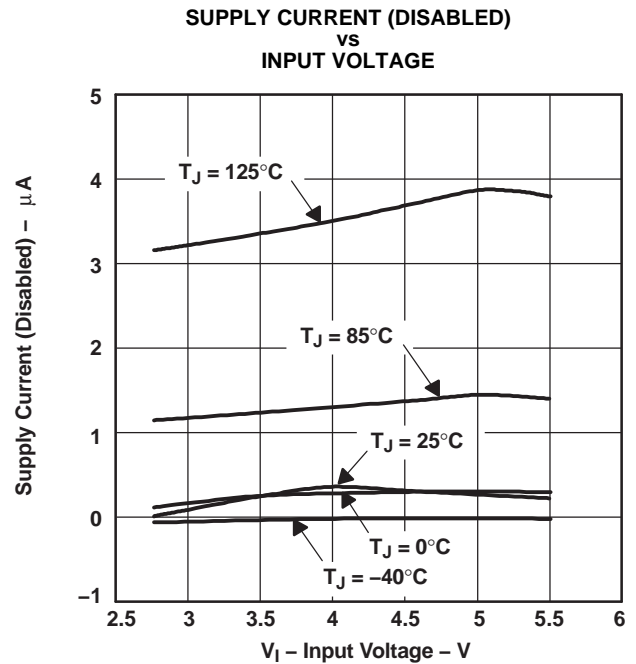

Figure 30.

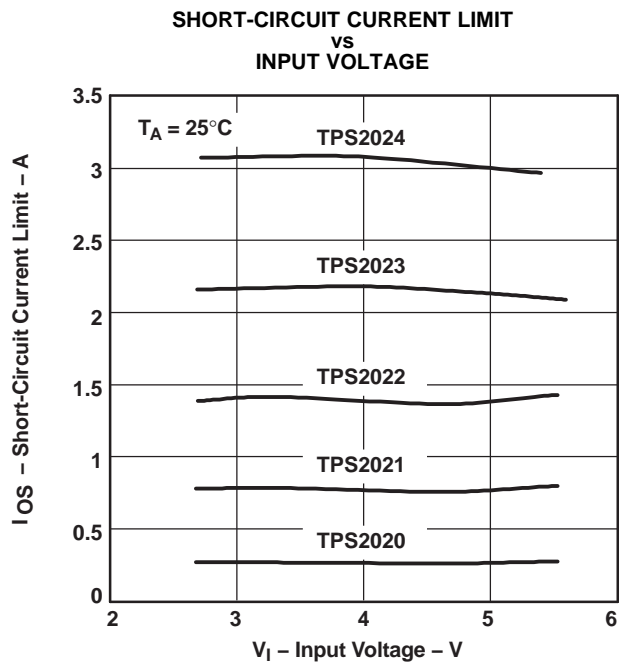

Figure 31.

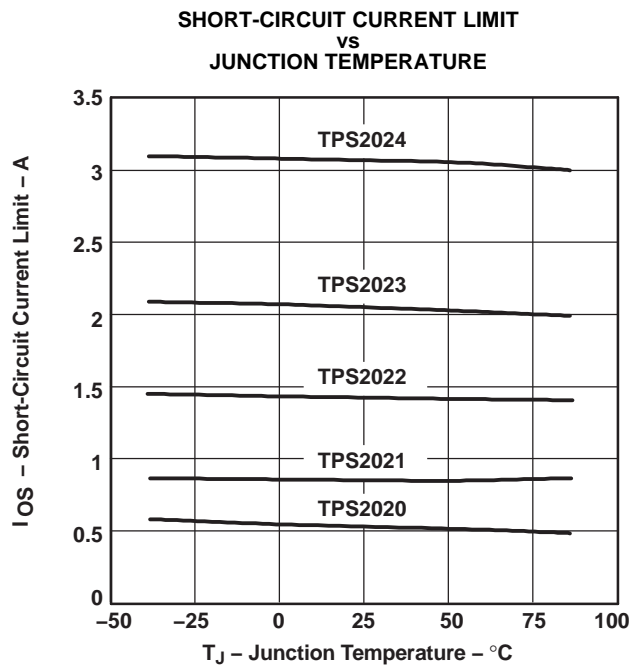

Figure 32.

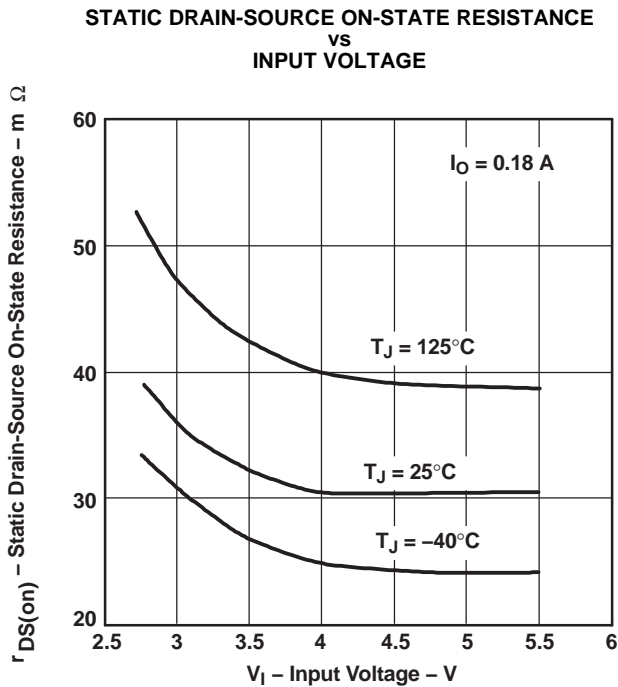

Figure 33.

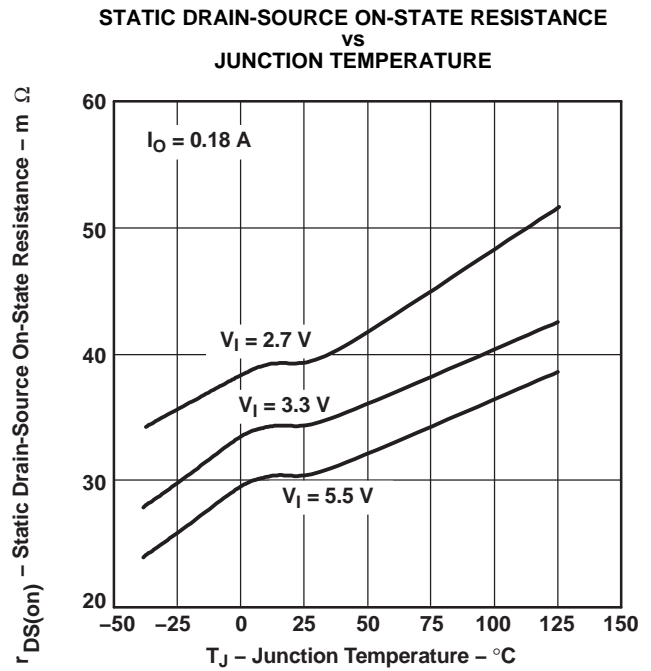

Figure 34.

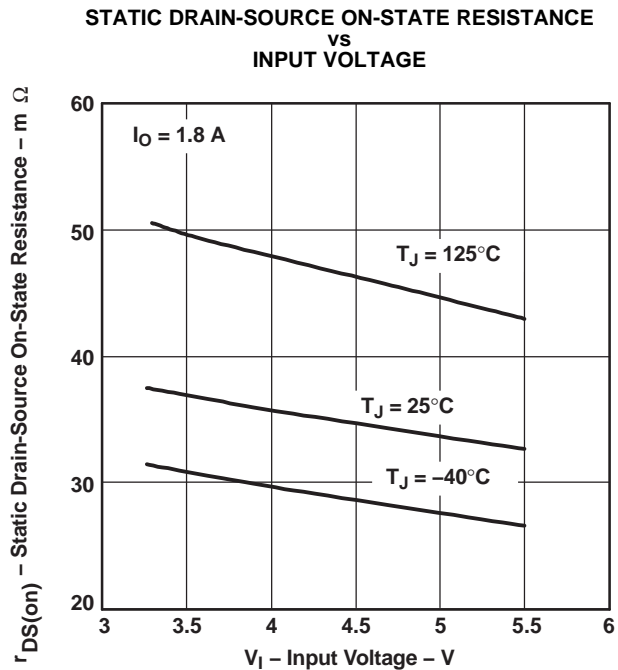

Figure 35.

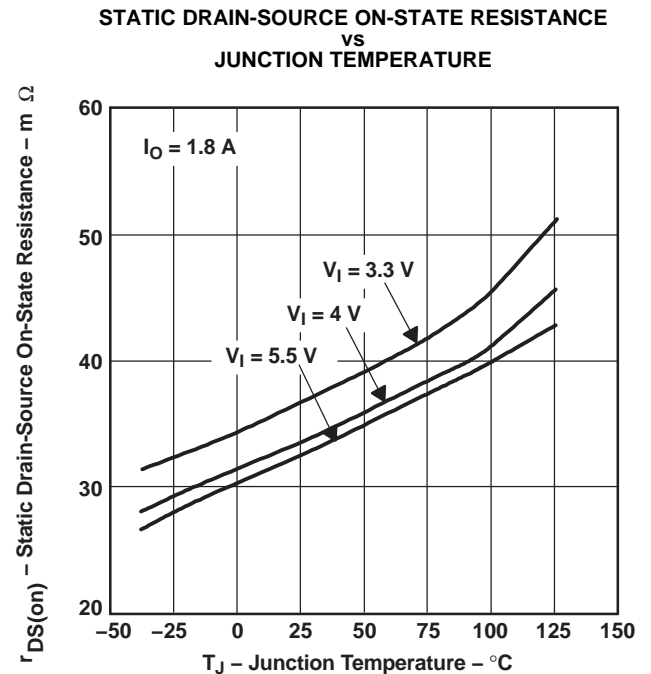

Figure 36.

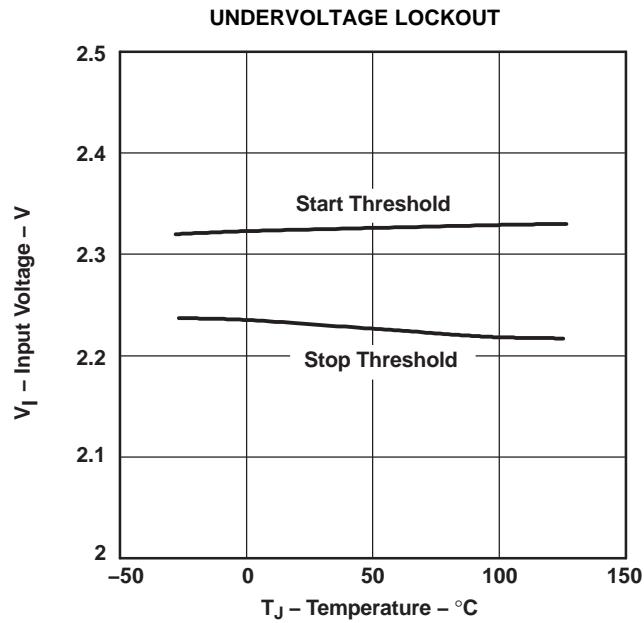

Figure 37.

APPLICATION INFORMATION

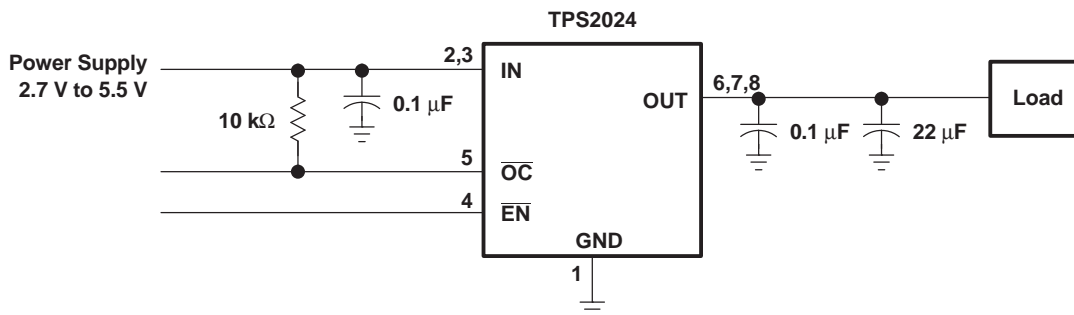

Figure 38. Typical Application

POWER SUPPLY CONSIDERATIONS

A 0.01- μF to 0.1- μF ceramic bypass capacitor between IN and GND, close to the device, is recommended. Placing a high-value electrolytic capacitor on the output and input pins is recommended when the output load is heavy. This precaution reduces power supply transients that may cause ringing on the input. Additionally, bypassing the output with a 0.01- μF to 0.1- μF ceramic capacitor improves the immunity of the device to short-circuit transients.

OVERCURRENT

A sense FET checks for overcurrent conditions. Unlike current-sense resistors, sense FETs do not increase the series resistance of the current path. When an overcurrent condition is detected, the device maintains a constant output current and reduces the output voltage accordingly. Complete shutdown occurs only if the fault is present long enough to activate thermal limiting.

Three possible overload conditions can occur. In the first condition, the output has been shorted before the device is enabled or before $V_{I(IN)}$ has been applied, see Figure 6. The TPS202x senses the short and immediately switches into a constant-current output.

In the second condition, the excessive load occurs while the device is enabled. At the instant the excessive load occurs, very high currents may flow for a short time before the current-limit circuit can react (see Figures 13–22). After the current-limit circuit has tripped (reached the overcurrent trip threshold) the device switches into constant-current mode.

In the third condition, the load has been gradually increased beyond the recommended operating current. The current is permitted to rise until the current-limit threshold is reached or until the thermal limit of the device is exceeded (see Figures 7–11). The TPS202x is capable of delivering current up to the current-limit threshold without damaging the device. Once the threshold has been reached, the device switches into its constant-current mode.

$\overline{\text{OC}}$ RESPONSE

The $\overline{\text{OC}}$ open-drain output is asserted (active low) when an overcurrent or overtemperature condition is encountered. The output remains asserted until the overcurrent or overtemperature condition is removed. Connecting a heavy capacitive load to an enabled device can cause momentary false overcurrent reporting from the inrush current flowing through the device, charging the downstream capacitor. An RC filter can be connected to the $\overline{\text{OC}}$ pin to reduce false overcurrent reporting. Using low-ESR electrolytic capacitors on the output lowers the inrush current flow through the device during hot-plug events by providing a low impedance energy source, thereby reducing erroneous overcurrent reporting.

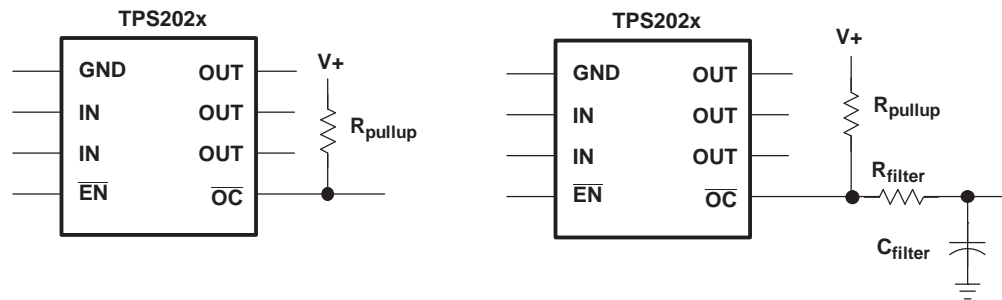

Figure 39. Typical Circuit for $\overline{\text{OC}}$ Pin and RC Filter for Damping Inrush $\overline{\text{OC}}$ Responses

POWER DISSIPATION AND JUNCTION TEMPERATURE

The low on-resistance on the n-channel MOSFET allows small surface-mount packages, such as SOIC, to pass large currents. The thermal resistances of these packages are high compared to those of power packages; it is good design practice to check power dissipation and junction temperature. The first step is to find $r_{\text{DS(on)}}$ at the input voltage and operating temperature. As an initial estimate, use the highest operating ambient temperature of interest and read $r_{\text{DS(on)}}$ from Figures 33–36. Next, calculate the power dissipation using:

$$P_D = r_{\text{DS(on)}} \times I^2$$

Finally, calculate the junction temperature:

$$T_J = P_D \times R_{\theta\text{JA}} + T_A$$

where:

T_A = Ambient temperature °C

$R_{\theta\text{JA}}$ = Thermal resistance—SOIC = 172°C/W, PDIP = 106°C/W

Compare the calculated junction temperature with the initial estimate. If they do not agree within a few degrees, repeat the calculation, using the calculated value as the new estimate. Two or three iterations are generally sufficient to get an acceptable answer.

THERMAL PROTECTION

Thermal protection prevents damage to the IC when heavy-overload or short-circuit faults are present for extended periods of time. The faults force the TPS202x into constant current mode, which causes the voltage across the high-side switch to increase; under short-circuit conditions, the voltage across the switch is equal to the input voltage. The increased dissipation causes the junction temperature to rise to high levels. The protection circuit senses the junction temperature of the switch and shuts it off. Hysteresis is built into the thermal sense circuit, and after the device has cooled approximately 20 degrees, the switch turns back on. The switch continues to cycle in this manner until the load fault or input power is removed.

UNDERVOLTAGE LOCKOUT (UVLO)

An undervoltage lockout ensures that the power switch is in the off state at powerup. Whenever the input voltage falls below approximately 2 V, the power switch is quickly turned off. This facilitates the design of hot-insertion systems where it is not possible to turn off the power switch before input power is removed. The UVLO also keeps the switch from being turned on until the power supply has reached at least 2 V, even if the switch is enabled. Upon reinsertion, the power switch is turned on, with a controlled rise time to reduce EMI and voltage overshoots.

GENERIC HOT-PLUG APPLICATIONS (See [Figure 40](#))

In many applications it may be necessary to remove modules or pc boards while the main unit is still operating. These are considered hot-plug applications. Such implementations require the control of current surges seen by the main power supply and the card being inserted. The most effective way to control these surges is to limit and slowly ramp the current and voltage being applied to the card, similar to the way in which a power supply normally turns on. Because of the controlled rise times and fall times of the TPS202x series, these devices can be used to provide a softer start-up to devices being hot-plugged into a powered system. The UVLO feature of the TPS202x also ensures the switch is off after the card has been removed, and the switch remains off during the next insertion. The UVLO feature ensures a soft start with a controlled rise time for every insertion of the card or module.

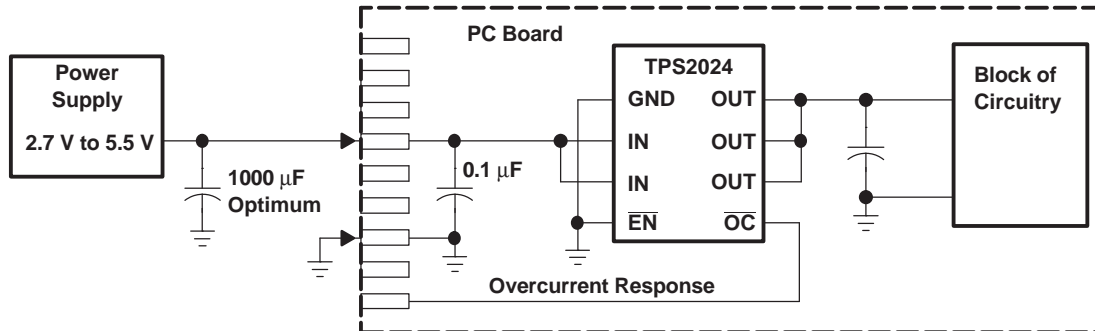

Figure 40. Typical Hot-Plug Implementation

By placing the TPS202x between the V_{CC} input and the rest of the circuitry, the input power reaches this device first after insertion. The typical rise time of the switch is approximately 9 ms, providing a slow voltage ramp at the output of the device. This implementation controls system surge currents and provides a hot-plugging mechanism for any device.

PACKAGING INFORMATION

Orderable Device	Status ⁽¹⁾	Package Type	Package Drawing	Pins	Package Qty	Eco Plan ⁽²⁾	Lead/ Ball Finish	MSL Peak Temp ⁽³⁾	Samples (Requires Login)
TPS2020D	ACTIVE	SOIC	D	8	75	Green (RoHS & no Sb/Br)	CU NIPDAU	Level-1-260C-UNLIM	Request Free Samples
TPS2020DG4	ACTIVE	SOIC	D	8	75	Green (RoHS & no Sb/Br)	CU NIPDAU	Level-1-260C-UNLIM	Request Free Samples
TPS2020DR	ACTIVE	SOIC	D	8	2500	Green (RoHS & no Sb/Br)	CU NIPDAU	Level-1-260C-UNLIM	Purchase Samples
TPS2020DRG4	ACTIVE	SOIC	D	8	2500	Green (RoHS & no Sb/Br)	CU NIPDAU	Level-1-260C-UNLIM	Purchase Samples
TPS2021D	ACTIVE	SOIC	D	8	75	Green (RoHS & no Sb/Br)	CU NIPDAU	Level-1-260C-UNLIM	Request Free Samples
TPS2021DG4	ACTIVE	SOIC	D	8	75	Green (RoHS & no Sb/Br)	CU NIPDAU	Level-1-260C-UNLIM	Request Free Samples
TPS2021DR	ACTIVE	SOIC	D	8	2500	Green (RoHS & no Sb/Br)	CU NIPDAU	Level-1-260C-UNLIM	Purchase Samples
TPS2021DRG4	ACTIVE	SOIC	D	8	2500	Green (RoHS & no Sb/Br)	CU NIPDAU	Level-1-260C-UNLIM	Purchase Samples
TPS2021P	ACTIVE	PDIP	P	8	50	Pb-Free (RoHS)	CU NIPDAU	N / A for Pkg Type	Purchase Samples
TPS2021PE4	ACTIVE	PDIP	P	8	50	Pb-Free (RoHS)	CU NIPDAU	N / A for Pkg Type	Purchase Samples
TPS2022D	ACTIVE	SOIC	D	8	75	Green (RoHS & no Sb/Br)	CU NIPDAU	Level-1-260C-UNLIM	Request Free Samples
TPS2022DG4	ACTIVE	SOIC	D	8	75	Green (RoHS & no Sb/Br)	CU NIPDAU	Level-1-260C-UNLIM	Request Free Samples
TPS2022DR	ACTIVE	SOIC	D	8	2500	Green (RoHS & no Sb/Br)	CU NIPDAU	Level-1-260C-UNLIM	Purchase Samples
TPS2022DRG4	ACTIVE	SOIC	D	8	2500	Green (RoHS & no Sb/Br)	CU NIPDAU	Level-1-260C-UNLIM	Purchase Samples
TPS2023D	ACTIVE	SOIC	D	8	75	Green (RoHS & no Sb/Br)	CU NIPDAU	Level-1-260C-UNLIM	Request Free Samples
TPS2023DG4	ACTIVE	SOIC	D	8	75	Green (RoHS & no Sb/Br)	CU NIPDAU	Level-1-260C-UNLIM	Request Free Samples
TPS2023DR	ACTIVE	SOIC	D	8	2500	Green (RoHS & no Sb/Br)	CU NIPDAU	Level-1-260C-UNLIM	Purchase Samples
TPS2023DRG4	ACTIVE	SOIC	D	8	2500	Green (RoHS & no Sb/Br)	CU NIPDAU	Level-1-260C-UNLIM	Purchase Samples

Orderable Device	Status ⁽¹⁾	Package Type	Package Drawing	Pins	Package Qty	Eco Plan ⁽²⁾	Lead/ Ball Finish	MSL Peak Temp ⁽³⁾	Samples (Requires Login)
TPS2023P	ACTIVE	PDIP	P	8	50	Pb-Free (RoHS)	CU NIPDAU	N / A for Pkg Type	Purchase Samples
TPS2023PE4	ACTIVE	PDIP	P	8	50	Pb-Free (RoHS)	CU NIPDAU	N / A for Pkg Type	Purchase Samples
TPS2024D	ACTIVE	SOIC	D	8	75	Green (RoHS & no Sb/Br)	CU NIPDAU	Level-1-260C-UNLIM	Purchase Samples
TPS2024DG4	ACTIVE	SOIC	D	8	75	Green (RoHS & no Sb/Br)	CU NIPDAU	Level-1-260C-UNLIM	Purchase Samples
TPS2024DR	ACTIVE	SOIC	D	8	2500	Green (RoHS & no Sb/Br)	CU NIPDAU	Level-1-260C-UNLIM	Request Free Samples
TPS2024DRG4	ACTIVE	SOIC	D	8	2500	Green (RoHS & no Sb/Br)	CU NIPDAU	Level-1-260C-UNLIM	Request Free Samples
TPS2024P	ACTIVE	PDIP	P	8	50	Pb-Free (RoHS)	CU NIPDAU	N / A for Pkg Type	Purchase Samples
TPS2024PE4	ACTIVE	PDIP	P	8	50	Pb-Free (RoHS)	CU NIPDAU	N / A for Pkg Type	Purchase Samples

⁽¹⁾ The marketing status values are defined as follows:

ACTIVE: Product device recommended for new designs.

LIFEBUY: TI has announced that the device will be discontinued, and a lifetime-buy period is in effect.

NRND: Not recommended for new designs. Device is in production to support existing customers, but TI does not recommend using this part in a new design.

PREVIEW: Device has been announced but is not in production. Samples may or may not be available.

OBSOLETE: TI has discontinued the production of the device.

⁽²⁾ Eco Plan - The planned eco-friendly classification: Pb-Free (RoHS), Pb-Free (RoHS Exempt), or Green (RoHS & no Sb/Br) - please check <http://www.ti.com/productcontent> for the latest availability information and additional product content details.

TBD: The Pb-Free/Green conversion plan has not been defined.

Pb-Free (RoHS): TI's terms "Lead-Free" or "Pb-Free" mean semiconductor products that are compatible with the current RoHS requirements for all 6 substances, including the requirement that lead not exceed 0.1% by weight in homogeneous materials. Where designed to be soldered at high temperatures, TI Pb-Free products are suitable for use in specified lead-free processes.

Pb-Free (RoHS Exempt): This component has a RoHS exemption for either 1) lead-based flip-chip solder bumps used between the die and package, or 2) lead-based die adhesive used between the die and leadframe. The component is otherwise considered Pb-Free (RoHS compatible) as defined above.

Green (RoHS & no Sb/Br): TI defines "Green" to mean Pb-Free (RoHS compatible), and free of Bromine (Br) and Antimony (Sb) based flame retardants (Br or Sb do not exceed 0.1% by weight in homogeneous material)

⁽³⁾ MSL, Peak Temp. -- The Moisture Sensitivity Level rating according to the JEDEC industry standard classifications, and peak solder temperature.

Important Information and Disclaimer: The information provided on this page represents TI's knowledge and belief as of the date that it is provided. TI bases its knowledge and belief on information provided by third parties, and makes no representation or warranty as to the accuracy of such information. Efforts are underway to better integrate information from third parties. TI has taken and continues to take reasonable steps to provide representative and accurate information but may not have conducted destructive testing or chemical analysis on incoming materials and chemicals. TI and TI suppliers consider certain information to be proprietary, and thus CAS numbers and other limited information may not be available for release.

In no event shall TI's liability arising out of such information exceed the total purchase price of the TI part(s) at issue in this document sold by TI to Customer on an annual basis.

OTHER QUALIFIED VERSIONS OF TPS2020, TPS2021, TPS2022, TPS2024 :

- Automotive: [TPS2020-Q1](#), [TPS2021-Q1](#), [TPS2022-Q1](#), [TPS2024-Q1](#)

NOTE: Qualified Version Definitions:

- Automotive - Q100 devices qualified for high-reliability automotive applications targeting zero defects

TAPE AND REEL INFORMATION



QUADRANT ASSIGNMENTS FOR PIN 1 ORIENTATION IN TAPE



*All dimensions are nominal

Device	Package Type	Package Drawing	Pins	SPQ	Reel Diameter (mm)	Reel Width W1 (mm)	A0 (mm)	B0 (mm)	K0 (mm)	P1 (mm)	W (mm)	Pin1 Quadrant
TPS2020DR	SOIC	D	8	2500	330.0	12.4	6.4	5.2	2.1	8.0	12.0	Q1
TPS2021DR	SOIC	D	8	2500	330.0	12.4	6.4	5.2	2.1	8.0	12.0	Q1
TPS2022DR	SOIC	D	8	2500	330.0	12.4	6.4	5.2	2.1	8.0	12.0	Q1
TPS2023DR	SOIC	D	8	2500	330.0	12.4	6.4	5.2	2.1	8.0	12.0	Q1
TPS2024DR	SOIC	D	8	2500	330.0	12.4	6.4	5.2	2.1	8.0	12.0	Q1

TAPE AND REEL BOX DIMENSIONS



*All dimensions are nominal

Device	Package Type	Package Drawing	Pins	SPQ	Length (mm)	Width (mm)	Height (mm)
TPS2020DR	SOIC	D	8	2500	340.5	338.1	20.6
TPS2021DR	SOIC	D	8	2500	340.5	338.1	20.6
TPS2022DR	SOIC	D	8	2500	340.5	338.1	20.6
TPS2023DR	SOIC	D	8	2500	340.5	338.1	20.6
TPS2024DR	SOIC	D	8	2500	340.5	338.1	20.6

P (R-PDIP-T8)

PLASTIC DUAL-IN-LINE PACKAGE

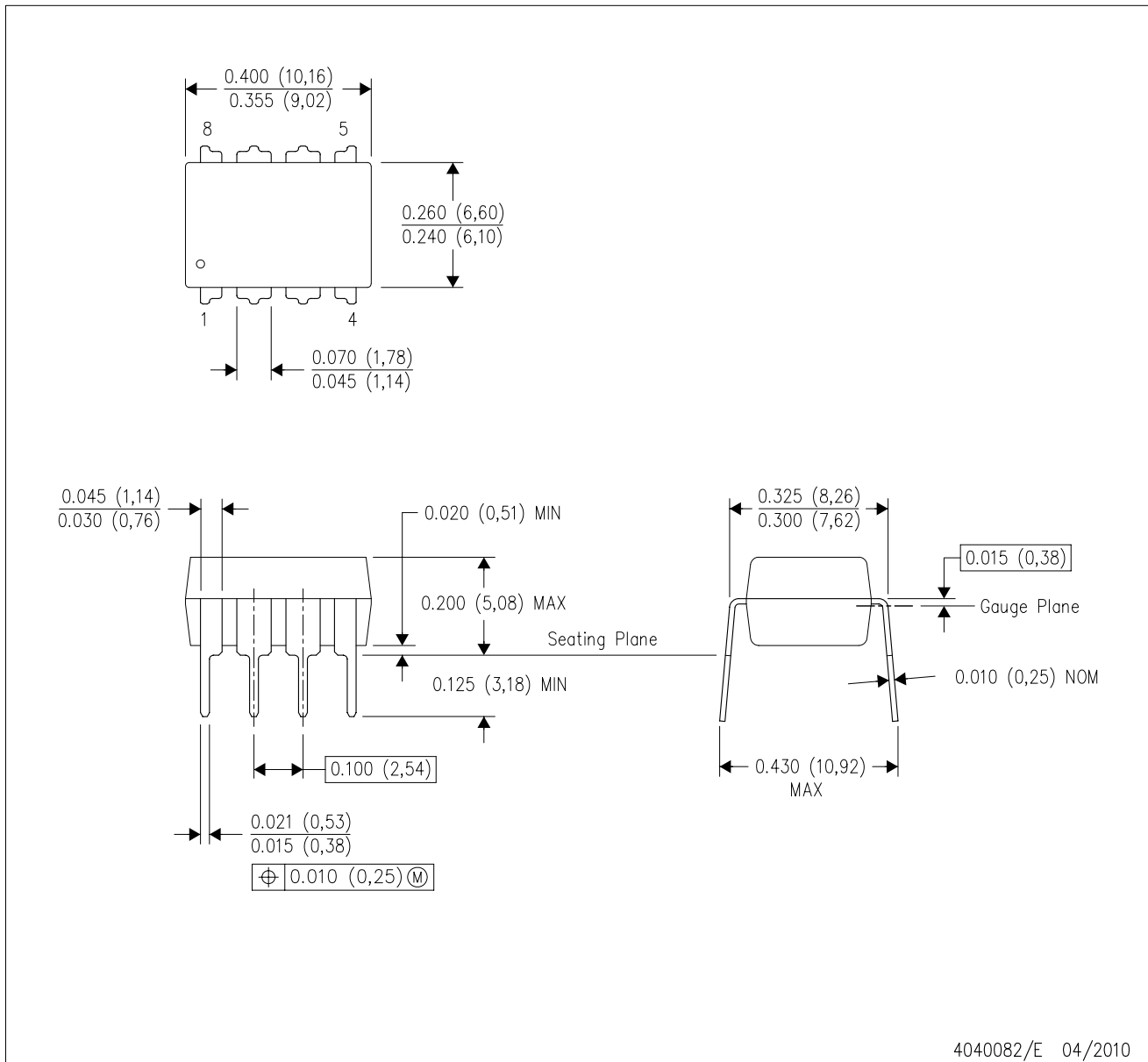



- NOTES:
- A. All linear dimensions are in inches (millimeters).
 - B. This drawing is subject to change without notice.
 - C. Falls within JEDEC MS-001 variation BA.

D (R-PDSO-G8)

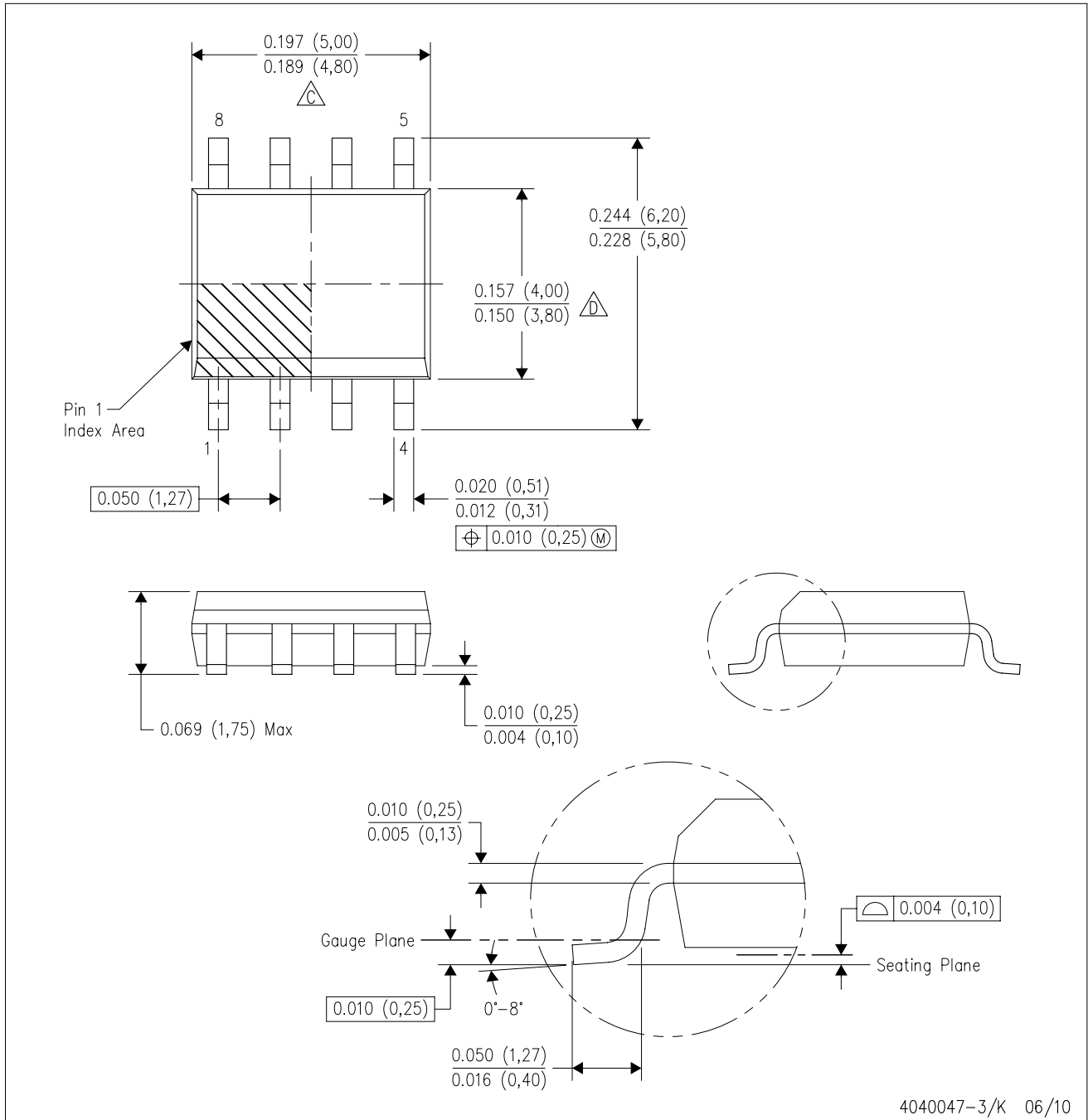
PLASTIC SMALL-OUTLINE PACKAGE



- NOTES:
- A. All linear dimensions are in inches (millimeters).
 - B. This drawing is subject to change without notice.
 -  Body length does not include mold flash, protrusions, or gate burrs. Mold flash, protrusions, or gate burrs shall not exceed .006 (0,15) per end.
 -  Body width does not include interlead flash. Interlead flash shall not exceed .017 (0,43) per side.
 - E. Reference JEDEC MS-012 variation AA.

D (R-PDSO-G8)

PLASTIC SMALL OUTLINE

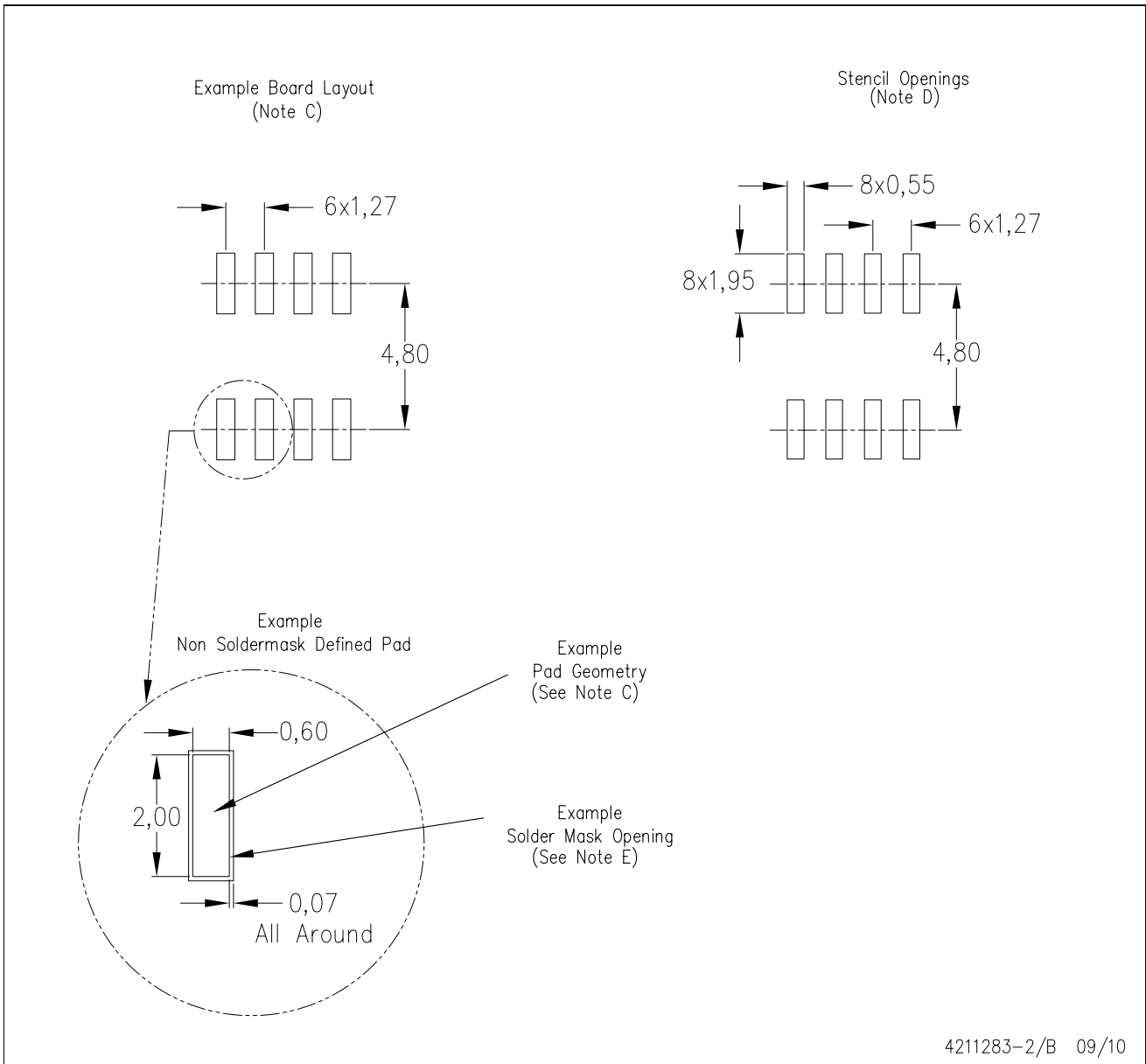

- NOTES:
- All linear dimensions are in millimeters.
 - This drawing is subject to change without notice.
 - Publication IPC-7351 is recommended for alternate designs.
 - Laser cutting apertures with trapezoidal walls and also rounding corners will offer better paste release. Customers should contact their board assembly site for stencil design recommendations. Refer to IPC-7525 for other stencil recommendations.
 - Customers should contact their board fabrication site for solder mask tolerances between and around signal pads.

IMPORTANT NOTICE

Texas Instruments Incorporated and its subsidiaries (TI) reserve the right to make corrections, modifications, enhancements, improvements, and other changes to its products and services at any time and to discontinue any product or service without notice. Customers should obtain the latest relevant information before placing orders and should verify that such information is current and complete. All products are sold subject to TI's terms and conditions of sale supplied at the time of order acknowledgment.

TI warrants performance of its hardware products to the specifications applicable at the time of sale in accordance with TI's standard warranty. Testing and other quality control techniques are used to the extent TI deems necessary to support this warranty. Except where mandated by government requirements, testing of all parameters of each product is not necessarily performed.

TI assumes no liability for applications assistance or customer product design. Customers are responsible for their products and applications using TI components. To minimize the risks associated with customer products and applications, customers should provide adequate design and operating safeguards.

TI does not warrant or represent that any license, either express or implied, is granted under any TI patent right, copyright, mask work right, or other TI intellectual property right relating to any combination, machine, or process in which TI products or services are used. Information published by TI regarding third-party products or services does not constitute a license from TI to use such products or services or a warranty or endorsement thereof. Use of such information may require a license from a third party under the patents or other intellectual property of the third party, or a license from TI under the patents or other intellectual property of TI.

Reproduction of TI information in TI data books or data sheets is permissible only if reproduction is without alteration and is accompanied by all associated warranties, conditions, limitations, and notices. Reproduction of this information with alteration is an unfair and deceptive business practice. TI is not responsible or liable for such altered documentation. Information of third parties may be subject to additional restrictions.

Resale of TI products or services with statements different from or beyond the parameters stated by TI for that product or service voids all express and any implied warranties for the associated TI product or service and is an unfair and deceptive business practice. TI is not responsible or liable for any such statements.

TI products are not authorized for use in safety-critical applications (such as life support) where a failure of the TI product would reasonably be expected to cause severe personal injury or death, unless officers of the parties have executed an agreement specifically governing such use. Buyers represent that they have all necessary expertise in the safety and regulatory ramifications of their applications, and acknowledge and agree that they are solely responsible for all legal, regulatory and safety-related requirements concerning their products and any use of TI products in such safety-critical applications, notwithstanding any applications-related information or support that may be provided by TI. Further, Buyers must fully indemnify TI and its representatives against any damages arising out of the use of TI products in such safety-critical applications.

TI products are neither designed nor intended for use in military/aerospace applications or environments unless the TI products are specifically designated by TI as military-grade or "enhanced plastic." Only products designated by TI as military-grade meet military specifications. Buyers acknowledge and agree that any such use of TI products which TI has not designated as military-grade is solely at the Buyer's risk, and that they are solely responsible for compliance with all legal and regulatory requirements in connection with such use.

TI products are neither designed nor intended for use in automotive applications or environments unless the specific TI products are designated by TI as compliant with ISO/TS 16949 requirements. Buyers acknowledge and agree that, if they use any non-designated products in automotive applications, TI will not be responsible for any failure to meet such requirements.

Following are URLs where you can obtain information on other Texas Instruments products and application solutions:

Products		Applications	
Amplifiers	amplifier.ti.com	Audio	www.ti.com/audio
Data Converters	dataconverter.ti.com	Automotive	www.ti.com/automotive
DLP® Products	www.dlp.com	Communications and Telecom	www.ti.com/communications
DSP	dsp.ti.com	Computers and Peripherals	www.ti.com/computers
Clocks and Timers	www.ti.com/clocks	Consumer Electronics	www.ti.com/consumer-apps
Interface	interface.ti.com	Energy	www.ti.com/energy
Logic	logic.ti.com	Industrial	www.ti.com/industrial
Power Mgmt	power.ti.com	Medical	www.ti.com/medical
Microcontrollers	microcontroller.ti.com	Security	www.ti.com/security
RFID	www.ti-rfid.com	Space, Avionics & Defense	www.ti.com/space-avionics-defense
RF/IF and ZigBee® Solutions	www.ti.com/lprf	Video and Imaging	www.ti.com/video
		Wireless	www.ti.com/wireless-apps

Mailing Address: Texas Instruments, Post Office Box 655303, Dallas, Texas 75265
Copyright © 2010, Texas Instruments Incorporated

www.BDTIC.com/TI