

LOW INPUT VOLTAGE, ULTRA-LOW r_{ON} LOAD SWITCHES

FEATURES

- **Input Voltage: 0.9 V to 3.6 V**
- **Ultra-Low ON Resistance**
 - $r_{ON} = 14\text{ m}\Omega$ at $V_{IN} = 3.6\text{ V}$
 - $r_{ON} = 20\text{ m}\Omega$ at $V_{IN} = 2.5\text{ V}$
 - $r_{ON} = 33\text{ m}\Omega$ at $V_{IN} = 1.8\text{ V}$
 - $r_{ON} = 67\text{ m}\Omega$ at $V_{IN} = 1.2\text{ V}$
 - $r_{ON} = 116\text{ m}\Omega$ at $V_{IN} = 1.0\text{ V}$
- **2-A Maximum Continuous Switch Current**
- **Ultra-Low Quiescent Current: 78 nA at 1.8 V**
- **Ultra-Low Shutdown Current: 35 nA at 1.8 V**
- **Low Threshold Control Input Enable the use of 1.2V/1.8V/2.5V/3.3V Logic**
- **Controlled Slew Rate to Avoid Inrush Currents**
 - **TPS22921 and TPS22922: 30 μs**
 - **TPS22922B: 200 μs**
- **ESD Performance Tested Per JESD 22**
 - **3000-V Human-Body Model (A114-B, Class II)**
 - **1000-V Charged-Device Model (C101)**
- **Six Terminal Wafer-Chip-Scale Package**
 - **0.9 mm \times 1.4 mm, 0.5 mm Pitch, 0.5 mm Height**
 - **0.8 mm \times 1.2 mm, 0.4 mm Pitch, 0.5 mm Height**

APPLICATIONS

- PDAs
- Cell Phones
- GPS Devices
- MP3 Players
- Peripheral Ports
- Portable Media Players
- RF Modules

DESCRIPTION

TPS22921, TPS22922, and TPS22922B are ultra-low r_{ON} load switches with controlled turn on. TPS22921/2/2B contain an ultra-low r_{ON} P-channel MOSFET that can operate over an input voltage range of 0.9 V to 3.6 V. The switch is controlled by an on/off input (ON), which is capable of interfacing directly with low-voltage control signals. In TPS22922 and in TPS22922B, a 120- Ω on-chip load resistor is added for output quick discharge when switch is turned off. The rise time (slew rate) of the device is internally controlled in order to avoid inrush current: TPS22921 and TPS22922 feature a 30 μs rise time whereas TPS22922B is 200 μs .

TPS22921, TPS22922, and TPS22922B feature ultra low quiescent and shutdown current and are available in space-saving 6-terminals wafer-chip-scale packages (WCSP: YZP with 0.5-mm pitch and YFP with 0.4-mm pitch) which make it ideal for portable electronics. The devices are characterized for operation over the free-air temperature range of -40°C to 85°C .

YFP, YZP, AND YZT PACKAGES

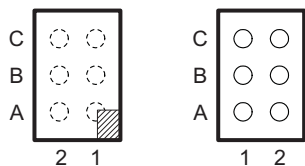

Laser Marking View Bump View

TERMINAL ASSIGNMENTS

C	ON	GND
B	V_{IN}	V_{OUT}
A	V_{IN}	V_{OUT}
	2	1

	r_{ON} AT 1.8 V (TYP)	SLEW RATE (TYP at 1.8V)	QUICK OUTPUT DISCHARGE ⁽¹⁾	MAX OUTPUT CURRENT	ENABLE
TPS22921	33 m Ω	30 μs		2 A	active high
TPS22922	33 m Ω	30 μs	Yes	2 A	active high
TPS22922B	33 m Ω	200 μs	Yes	2 A	active high

(1) This feature discharges the output of the switch to ground through a 120- Ω resistor, preventing the output from floating.



Please be aware that an important notice concerning availability, standard warranty, and use in critical applications of Texas Instruments semiconductor products and disclaimers thereto appears at the end of this data sheet.

ORDERING INFORMATION

T _A	PACKAGE ⁽¹⁾⁽²⁾		ORDERABLE PART NUMBER	TOP-SIDE MARKING
-40°C to 85°C	WCSP – YFP (0.4 mm pitch)	Tape and reel	TPS22921YFPR	__ _3Y_
			TPS22922YFPR	__ _2Z_
			TPS22922BYFPR	PREVIEW
	WCSP – YZP (0.5 mm pitch)	Tape and reel	TPS22921YZPR	__ _3Y_
			TPS22922YZPR	__ _2Z_
			TPS22922BYZPR	__ _3Z_
WCSP – YZT (0.5 mm pitch)	Tape and reel	TPS22921YZTR	__ _3Y_	

- (1) Package drawings, thermal data, and symbolization are available at www.ti.com/packaging.
- (2) For the most current package and ordering information, see the Package Option Addendum at the end of this document, or see the TI website at www.ti.com.

TYPICAL APPLICATION

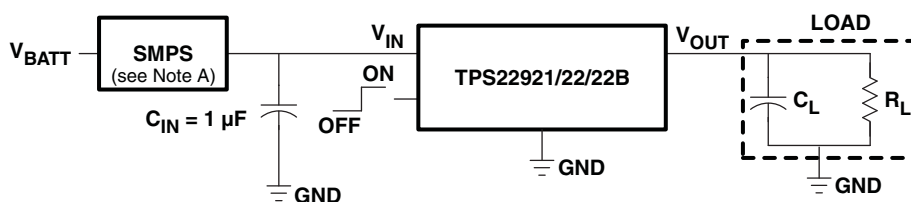

A. Switched mode power supply

APPLICATION BLOCK DIAGRAM

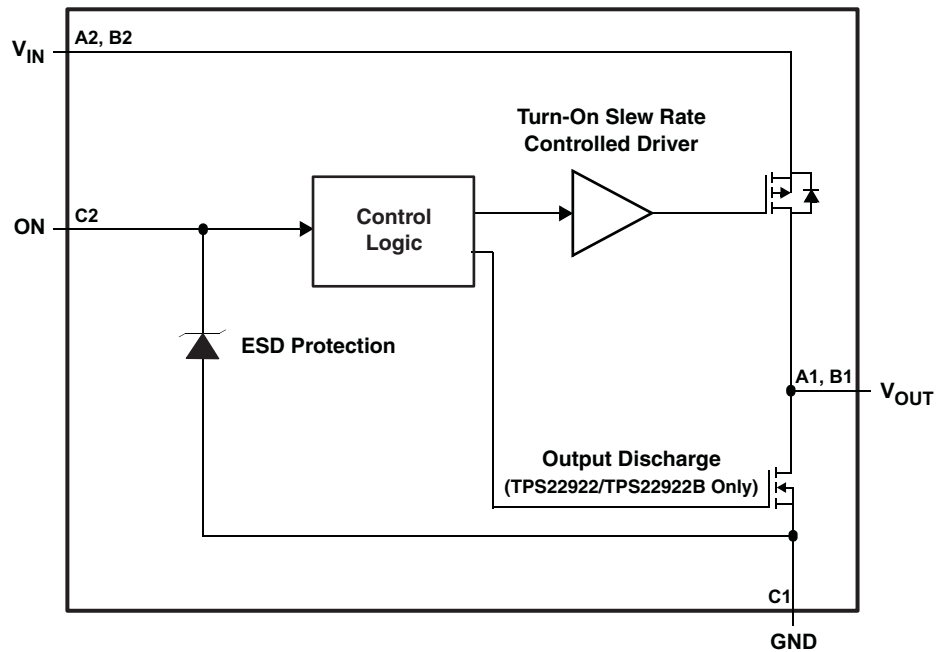

Figure 1. Functional Block Diagram

FUNCTION TABLE

ON	V _{IN} TO V _{OUT}	V _{OUT} TO GND ⁽¹⁾
L	OFF	ON
H	ON	OFF

(1) TPS22922/TPS22922B only

TERMINAL FUNCTIONS

TERMINAL		DESCRIPTION
NO.	NAME	
A1, B1	V _{OUT}	Switch output
A2, B2	V _{IN}	Switch input
C1	GND	Ground
C2	ON	Switch control input, active high. Do not leave floating

ABSOLUTE MAXIMUM RATINGS⁽¹⁾

		MIN	MAX	UNIT
V _{IN}	Input voltage range	-0.3	4	V
V _{OUT}	Output voltage range		V _{IN} + 0.3	V
V _{ON}	Input voltage range	-0.3	4	V
P	Power dissipation at T _A = 25°C		0.645	W
I _{MAX}	Maximum continuous switch current		2	A
T _A	Operating free-air temperature range	-40	85	°C
T _{stg}	Storage temperature range	-65	150	°C
T _{lead}	Maximum lead temperature (10-s soldering time)		300	°C
ESD	Electrostatic discharge protection	Human-Body Model (HBM)	3000	V
		Charged Device Model (CDM)	1000	
		Machine Model (MM)	300	

(1) Stresses beyond those listed under absolute maximum ratings may cause permanent damage to the device. These are stress ratings only, and functional operation of the device at these or any other conditions beyond those indicated under *Recommended Operating Conditions* is not implied. Exposure to absolute-maximum-rated conditions for extended periods may affect device reliability.

THERMAL IMPEDANCE RATINGS

			UNIT
θ _{JA}	Package thermal impedance ⁽¹⁾	YFP package	155
		YZP/YZT package	123

(1) The package thermal impedance is calculated in accordance with JESD 51-7.

RECOMMENDED OPERATING CONDITIONS

		MIN	MAX	UNIT
V _{IN}	Input voltage range	0.9	3.6	V
V _{OUT}	Output voltage range		V _{IN}	
V _{IH}	High-level input voltage, ON	0.85	3.6	V
V _{IL}	Low-level input voltage, ON		0.4	V
C _{IN}	Input capacitor	1 ⁽¹⁾		μF

(1) Refer to [Application Information](#).

ELECTRICAL CHARACTERISTICS
 $V_{IN} = 0.9\text{ V to }3.6\text{ V}$, $T_A = -40^\circ\text{C to }85^\circ\text{C}$ (unless otherwise noted)

PARAMETER		TEST CONDITIONS		T_A	MIN	TYP ⁽¹⁾	MAX	UNIT
I_{IN}	Quiescent current	$I_{OUT} = 0$	$V_{IN} = 1\text{-V}$	Full		30	120	nA
			$V_{IN} = 1.8\text{-V}$	Full		78	235	
			$V_{IN} = 3.6\text{-V}$	Full		200	880	
$I_{IN(OFF)}$	OFF-state supply current	$V_{ON} = \text{GND}$, $\text{OUT} = \text{Open}$	$V_{IN} = 1\text{-V}$	Full		10	210	nA
			$V_{IN} = 1.8\text{-V}$	Full		35	260	
			$V_{IN} = 3.6\text{-V}$	Full		120	700	
$I_{IN(LEAKAGE)}$	OFF-state switch current	$V_{ON} = \text{GND}$, $V_{OUT} = 0$	$V_{IN} = 1\text{-V}$	Full		12	140	nA
			$V_{IN} = 1.8\text{-V}$	Full		50	230	
			$V_{IN} = 3.6\text{-V}$	Full		130	610	
r_{ON}	ON-state resistance	$I_{OUT} = -200\text{ mA}$,	$V_{IN} = 3.6\text{ V}$	25°C		14	45	mΩ
				Full			50	
			$V_{IN} = 2.5\text{ V}$	25°C		20	55	
				Full			60	
			$V_{IN} = 1.8\text{ V}$	25°C		33	65	
				Full			75	
			$V_{IN} = 1.2\text{ V}$	25°C		67	100	
				Full			120	
			$V_{IN} = 1.1\text{ V}$	25°C		82	150	
				Full			160	
			$V_{IN} = 1.0\text{ V}$	25°C		116	160	
				Full			170	
r_{PD}	Output pulldown resistance	$V_{IN} = 3.3\text{ V}$, $V_{ON} = 0$, $I_{OUT} = 30\text{ mA}$ (TPS22922/TPS22922B only)		25°C		65	120	Ω
I_{ON}	ON input leakage current	$V_{ON} = 1.1\text{ V to }3.6\text{ V}$ or GND		Full			25	nA

 (1) Typical values are at the specified V_{IN} and $T_A = 25^\circ\text{C}$.

SWITCHING CHARACTERISTICS
 $V_{IN} = 0.9\text{ V}$, $T_A = 25^\circ\text{C}$ (unless otherwise noted)

PARAMETER	TEST CONDITIONS		TPS22921			TPS22922 ⁽¹⁾			TPS22922B ⁽¹⁾			UNIT
			MIN	TYP	MAX	MIN	TYP	MAX	MIN	TYP	MAX	
t_{ON}	Turn-ON time	$R_L = 500\ \Omega$,	$C_L = 0.1\ \mu\text{F}$		121		121		638	μs		
			$C_L = 1\ \mu\text{F}$		160		160		712			
			$C_L = 3\ \mu\text{F}$		188		188		799			
t_{OFF}	Turn-OFF time	$R_L = 500\ \Omega$,	$C_L = 0.1\ \mu\text{F}$		46		40		40	μs		
			$C_L = 1\ \mu\text{F}$		308		279		279			
			$C_L = 3\ \mu\text{F}$		975		807		807			
t_r	V_{OUT} rise time	$R_L = 500\ \Omega$,	$C_L = 0.1\ \mu\text{F}$		60		60		462	μs		
			$C_L = 1\ \mu\text{F}$		85		85		465			
			$C_L = 3\ \mu\text{F}$		107		107		507			
t_f	V_{OUT} fall time	$R_L = 500\ \Omega$,	$C_L = 0.1\ \mu\text{F}$		119		51		51	μs		
			$C_L = 1\ \mu\text{F}$		969		434		434			
			$C_L = 3\ \mu\text{F}$		3174		1264		1264			

 (1) $R_{L_CHIP} = 120\ \Omega$

SWITCHING CHARACTERISTICS

V_{IN} = 1.0 V, T_A = 25°C (unless otherwise noted)

PARAMETER	TEST CONDITIONS		TPS22921			TPS22922 ⁽¹⁾			TPS22922B ⁽¹⁾			UNIT
			MIN	TYP	MAX	MIN	TYP	MAX	MIN	TYP	MAX	
t _{ON} Turn-ON time	R _L = 500 Ω,	C _L = 0.1 μF	105			105			549			μs
		C _L = 1 μF	136			136			613			
		C _L = 3 μF	157			157			683			
t _{OFF} Turn-OFF time	R _L = 500 Ω,	C _L = 0.1 μF	46			28			28			μs
		C _L = 1 μF	309			186			186			
		C _L = 3 μF	983			511			511			
t _r V _{OUT} rise time	R _L = 500 Ω,	C _L = 0.1 μF	51			51			386			μs
		C _L = 1 μF	78			78			388			
		C _L = 3 μF	88			88			419			
t _f V _{OUT} fall time	R _L = 500 Ω,	C _L = 0.1 μF	121			34			34			μs
		C _L = 1 μF	986			306			306			
		C _L = 3 μF	3300			908			908			

(1) R_L_CHIP = 120 Ω

SWITCHING CHARACTERISTICS

V_{IN} = 1.1 V, T_A = 25°C (unless otherwise noted)

PARAMETER	TEST CONDITIONS		TPS22921			TPS22922 ⁽¹⁾			TPS22922B ⁽¹⁾			UNIT
			MIN	TYP	MAX	MIN	TYP	MAX	MIN	TYP	MAX	
t _{ON} Turn-ON time	R _L = 500 Ω,	C _L = 0.1 μF	91			93			484			μs
		C _L = 1 μF	118			118			540			
		C _L = 3 μF	137			137			599			
t _{OFF} Turn-OFF time	R _L = 500 Ω,	C _L = 0.1 μF	44			21			21			μs
		C _L = 1 μF	311			144			144			
		C _L = 3 μF	99			383			383			
t _r V _{OUT} rise time	R _L = 500 Ω,	C _L = 0.1 μF	46			46			335			μs
		C _L = 1 μF	60			60			336			
		C _L = 3 μF	76			76			363			
t _f V _{OUT} fall time	R _L = 500 Ω,	C _L = 0.1 μF	122			29			29			μs
		C _L = 1 μF	1000			224			224			
		C _L = 3 μF	3300			732			732			

(1) R_L_CHIP = 120 Ω

SWITCHING CHARACTERISTICS
 $V_{IN} = 1.2\text{ V}$, $T_A = 25^\circ\text{C}$ (unless otherwise noted)

PARAMETER	TEST CONDITIONS		TPS22921			TPS22922 ⁽¹⁾			TPS22922B ⁽¹⁾			UNIT
			MIN	TYP	MAX	MIN	TYP	MAX	MIN	TYP	MAX	
t_{ON} Turn-ON time	$R_L = 500\ \Omega$,	$C_L = 0.1\ \mu\text{F}$	83			83			435			μs
		$C_L = 1\ \mu\text{F}$	103			103			485			
		$C_L = 3\ \mu\text{F}$	122			122			536			
t_{OFF} Turn-OFF time	$R_L = 500\ \Omega$,	$C_L = 0.1\ \mu\text{F}$	44			17			17			μs
		$C_L = 1\ \mu\text{F}$	312			117			117			
		$C_L = 3\ \mu\text{F}$	1000			319			319			
t_r V_{OUT} rise time	$R_L = 500\ \Omega$,	$C_L = 0.1\ \mu\text{F}$	41			41			301			μs
		$C_L = 1\ \mu\text{F}$	54			54			302			
		$C_L = 3\ \mu\text{F}$	67			67			325			
t_f V_{OUT} fall time	$R_L = 500\ \Omega$,	$C_L = 0.1\ \mu\text{F}$	123			25			25			μs
		$C_L = 1\ \mu\text{F}$	1000			214			214			
		$C_L = 3\ \mu\text{F}$	3400			632			632			

 (1) $R_{L_CHIP} = 120\ \Omega$
SWITCHING CHARACTERISTICS
 $V_{IN} = 1.8\text{ V}$, $T_A = 25^\circ\text{C}$ (unless otherwise noted)

PARAMETER	TEST CONDITIONS		TPS22921			TPS22922 ⁽¹⁾			TPS22922B ⁽¹⁾			UNIT
			MIN	TYP	MAX	MIN	TYP	MAX	MIN	TYP	MAX	
t_{ON} Turn-ON time	$R_L = 500\ \Omega$,	$C_L = 0.1\ \mu\text{F}$	54			54			282			μs
		$C_L = 1\ \mu\text{F}$	67			67			314			
		$C_L = 3\ \mu\text{F}$	78			78			344			
t_{OFF} Turn-OFF time	$R_L = 500\ \Omega$,	$C_L = 0.1\ \mu\text{F}$	41			10			10			μs
		$C_L = 1\ \mu\text{F}$	312			67			67			
		$C_L = 3\ \mu\text{F}$	1000			181			181			
t_r V_{OUT} rise time	$R_L = 500\ \Omega$,	$C_L = 0.1\ \mu\text{F}$	30			30			200			μs
		$C_L = 1\ \mu\text{F}$	37			37			202			
		$C_L = 3\ \mu\text{F}$	47			47			219			
t_f V_{OUT} fall time	$R_L = 500\ \Omega$,	$C_L = 0.1\ \mu\text{F}$	121			17			17			μs
		$C_L = 1\ \mu\text{F}$	1000			158			158			
		$C_L = 3\ \mu\text{F}$	3450			461			461			

 (1) $R_{L_CHIP} = 120\ \Omega$

SWITCHING CHARACTERISTICS

V_{IN} = 2.5 V, T_A = 25°C (unless otherwise noted)

PARAMETER	TEST CONDITIONS		TPS22921			TPS22922 ⁽¹⁾			TPS22922B ⁽¹⁾			UNIT
			MIN	TYP	MAX	MIN	TYP	MAX	MIN	TYP	MAX	
t _{ON} Turn-ON time	R _L = 500 Ω,	C _L = 0.1 μF	40			40			211			μs
		C _L = 1 μF	50			50			233			
		C _L = 3 μF	59			59			256			
t _{OFF} Turn-OFF time	R _L = 500 Ω,	C _L = 0.1 μF	41			10			10			μs
		C _L = 1 μF	316			56			56			
		C _L = 3 μF	1000			153			153			
t _r V _{OUT} rise time	R _L = 500 Ω,	C _L = 0.1 μF	23			23			164			μs
		C _L = 1 μF	29			29			165			
		C _L = 3 μF	38			38			177			
t _f V _{OUT} fall time	R _L = 500 Ω,	C _L = 0.1 μF	122			16			16			μs
		C _L = 1 μF	1086			147			147			
		C _L = 3 μF	3600			430			430			

(1) R_L_CHIP = 120 Ω

SWITCHING CHARACTERISTICS

V_{IN} = 3 V, T_A = 25°C (unless otherwise noted)

PARAMETER	TEST CONDITIONS		TPS22921			TPS22922 ⁽¹⁾			TPS22922B ⁽¹⁾			UNIT
			MIN	TYP	MAX	MIN	TYP	MAX	MIN	TYP	MAX	
t _{ON} Turn-ON time	R _L = 500 Ω,	C _L = 0.1 μF	30			30			182			μs
		C _L = 1 μF	38			38			201			
		C _L = 3 μF	45			45			221			
t _{OFF} Turn-OFF time	R _L = 500 Ω,	C _L = 0.1 μF	40			10			10			μs
		C _L = 1 μF	353			51			51			
		C _L = 3 μF	1036			139			139			
t _r V _{OUT} rise time	R _L = 500 Ω,	C _L = 0.1 μF	20			20			149			μs
		C _L = 1 μF	25			25			150			
		C _L = 3 μF	33			33			161			
t _f V _{OUT} fall time	R _L = 500 Ω,	C _L = 0.1 μF	104			15			15			μs
		C _L = 1 μF	1030			143			143			
		C _L = 3 μF	3230			419			419			

(1) R_L_CHIP = 120 Ω

SWITCHING CHARACTERISTICS
 $V_{IN} = 3.6\text{ V}$, $T_A = 25^\circ\text{C}$ (unless otherwise noted)

PARAMETER	TEST CONDITIONS		TPS22921			TPS22922 ⁽¹⁾			TPS22922B ⁽¹⁾			UNIT
			MIN	TYP	MAX	MIN	TYP	MAX	MIN	TYP	MAX	
t_{ON} Turn-ON time	$R_L = 500\ \Omega$,	$C_L = 0.1\ \mu\text{F}$		30		30		159			μs	
		$C_L = 1\ \mu\text{F}$		38		38		175				
		$C_L = 3\ \mu\text{F}$		45		45		193				
t_{OFF} Turn-OFF time	$R_L = 500\ \Omega$,	$C_L = 0.1\ \mu\text{F}$		42		10		10			μs	
		$C_L = 1\ \mu\text{F}$		310		51		51				
		$C_L = 3\ \mu\text{F}$		988		139		139				
t_r V_{OUT} rise time	$R_L = 500\ \Omega$,	$C_L = 0.1\ \mu\text{F}$		20		20		137			μs	
		$C_L = 1\ \mu\text{F}$		25		25		138				
		$C_L = 3\ \mu\text{F}$		33		33		148				
t_f V_{OUT} fall time	$R_L = 500\ \Omega$,	$C_L = 0.1\ \mu\text{F}$		120		15		15			μs	
		$C_L = 1\ \mu\text{F}$		1100		143		143				
		$C_L = 3\ \mu\text{F}$		3600		419		419				

 (1) $R_{L_CHIP} = 120\ \Omega$

TYPICAL CHARACTERISTICS

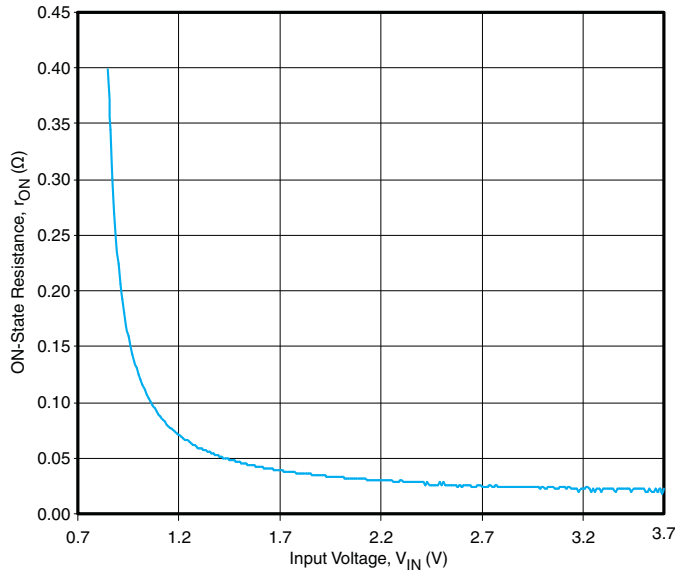

Figure 2. r_{ON} vs. V_{IN}

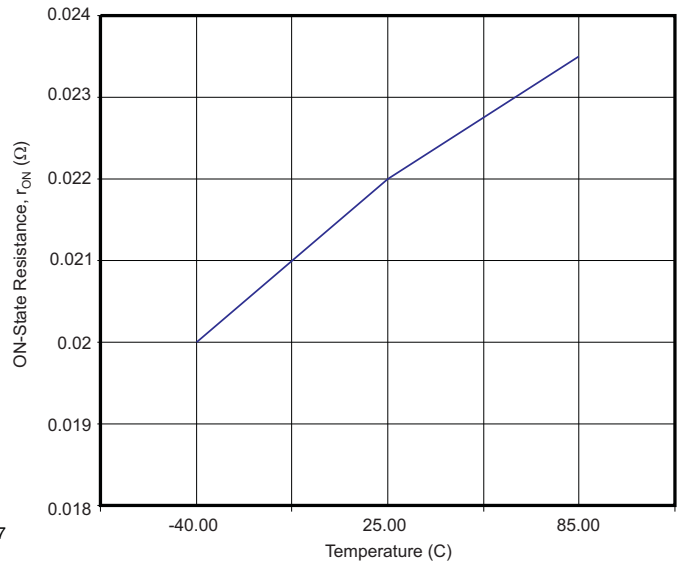

Figure 3. r_{ON} vs. Temperature ($V_{IN} = 3.3\text{ V}$)

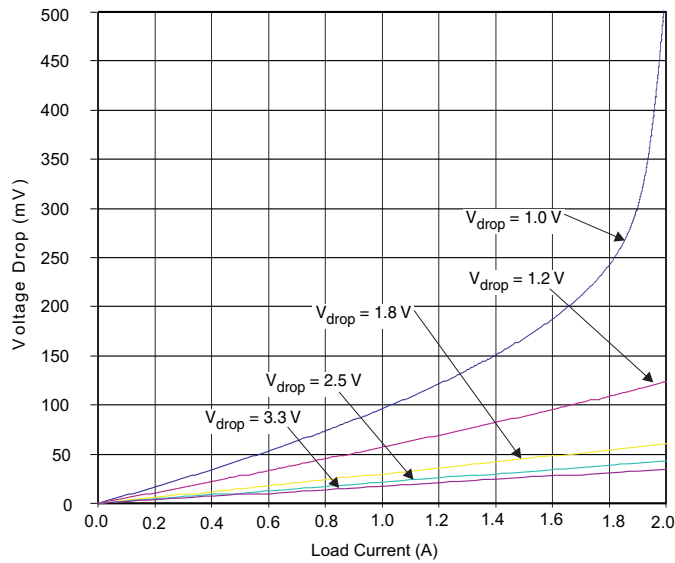

Figure 4. Voltage Drop vs Load Current

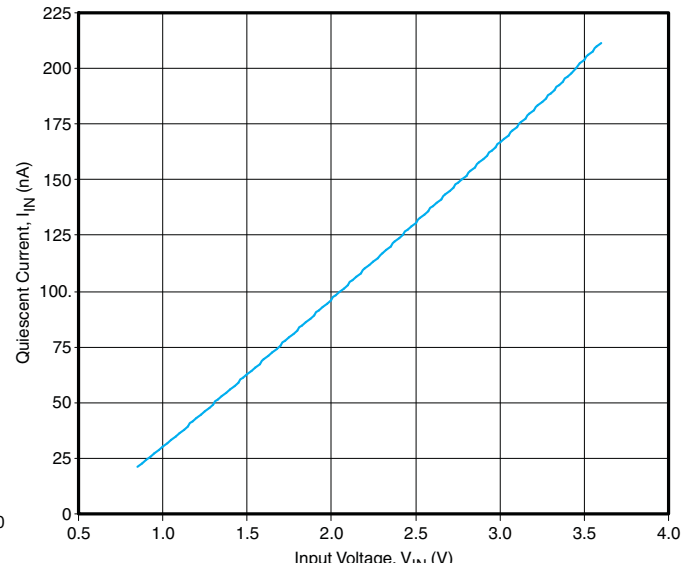

Figure 5. Quiescent Current vs. V_{IN} ($V_{ON} = V_{IN}$)

TYPICAL CHARACTERISTICS (continued)

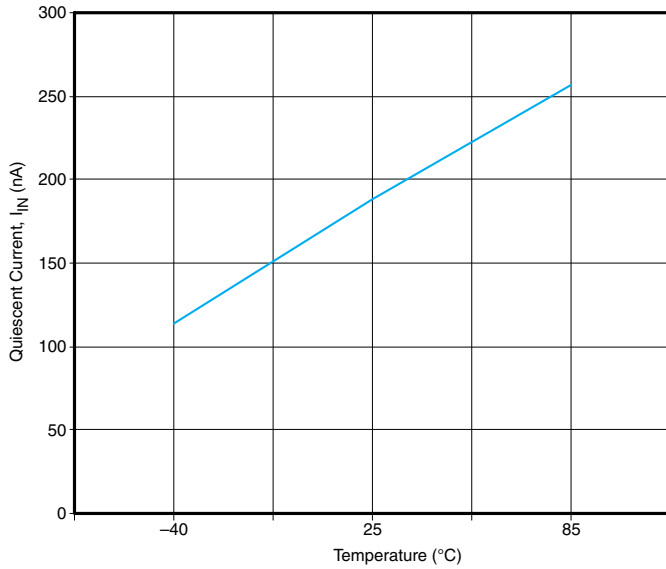

Figure 6. Quiescent Current vs. Temperature ($V_{IN} = 3.3\text{ V}$, $I_{OUT} = 0\text{ mA}$)

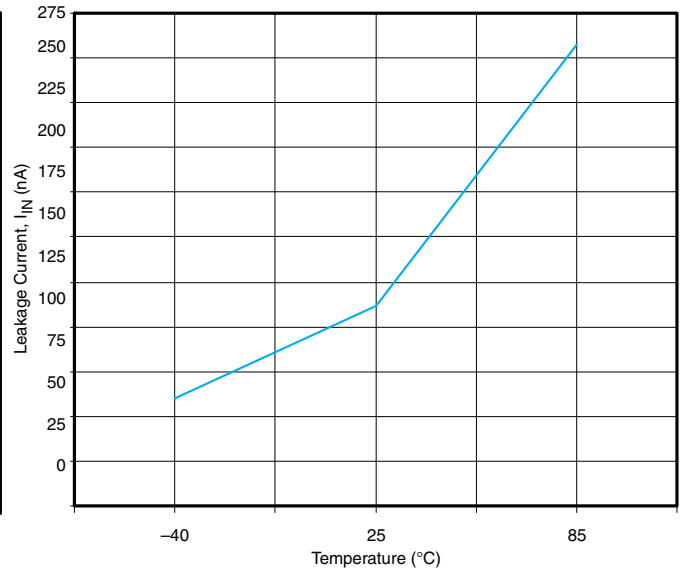

Figure 7. I_{IN} Leakage Current vs. Temperature ($V_{IN} = 3.3\text{ V}$)

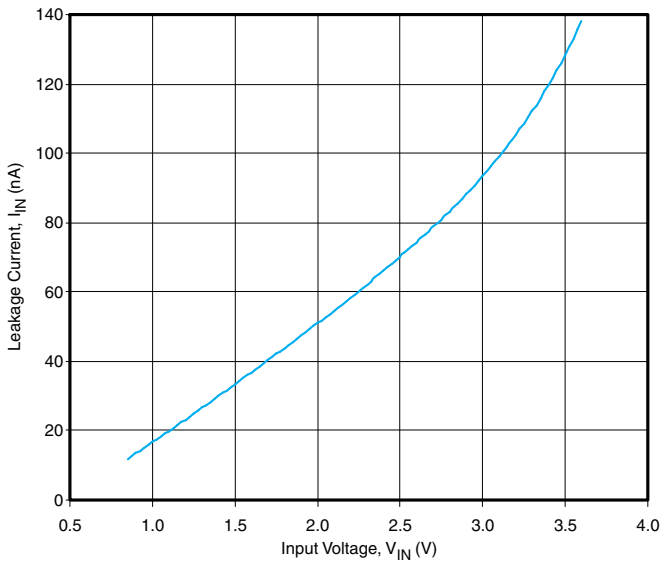

Figure 8. Leakage Current vs V_{IN}

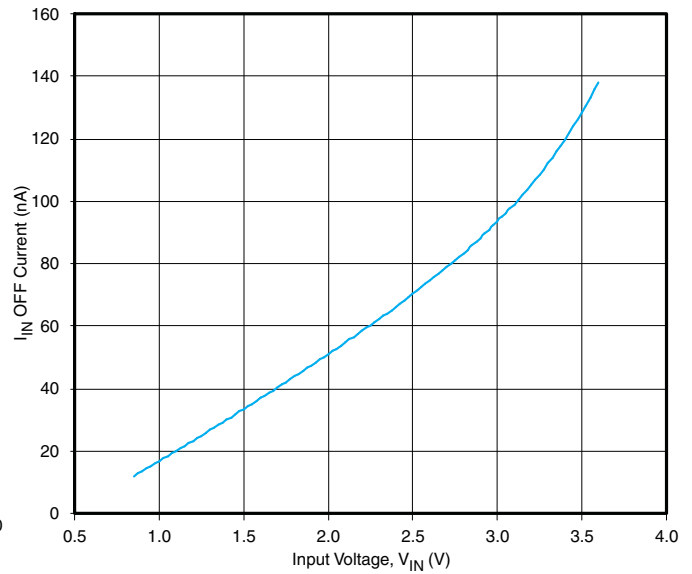

Figure 9. I_{IN} (OFF) vs V_{IN} ($V_{ON} = 0\text{ V}$)

TYPICAL CHARACTERISTICS (continued)

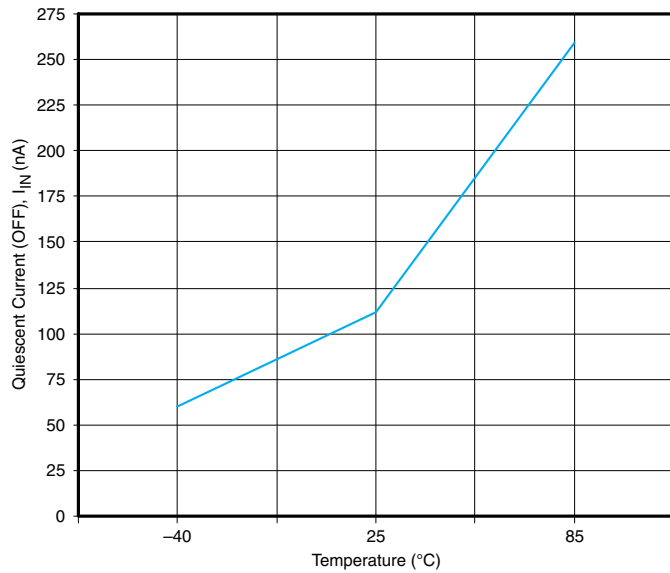

Figure 10. I_{IN} (OFF) vs Temperature ($V_{IN} = 3.3$ V)

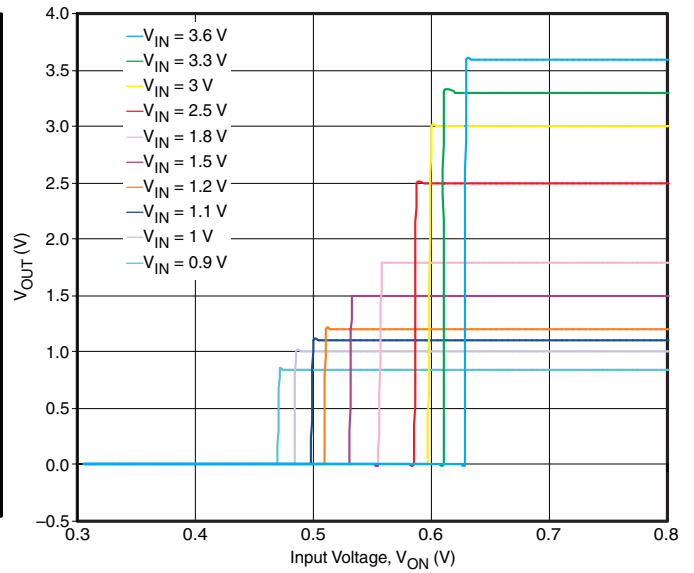

Figure 11. ON-Input Threshold

TPS22921

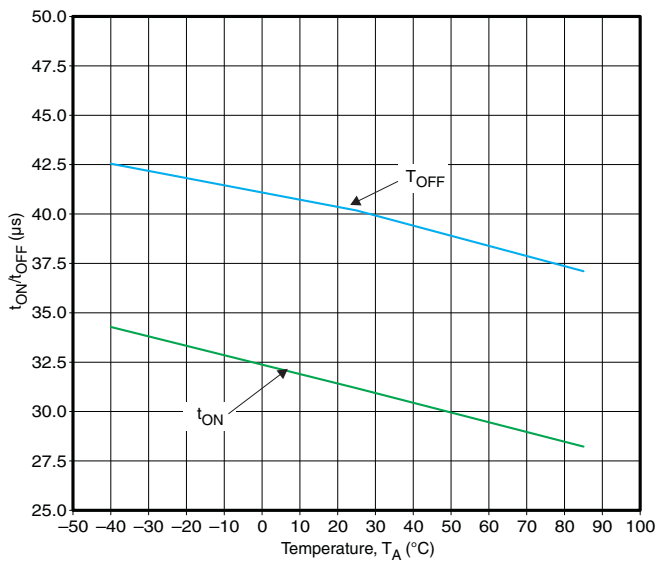

Figure 12. t_{ON}/t_{OFF} vs Temperature ($V_{IN} = 3.3$ V)

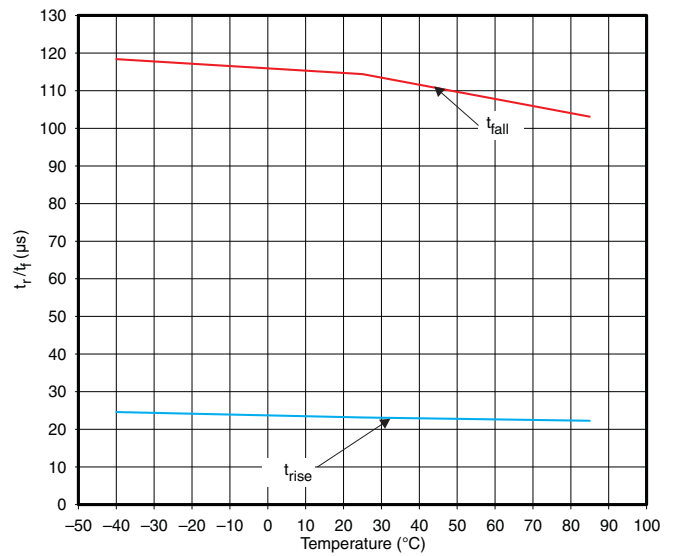

Figure 13. t_{rise}/t_{fall} vs Temperature ($V_{IN} = 3.3$ V)

TYPICAL CHARACTERISTICS (continued)

TPS22922

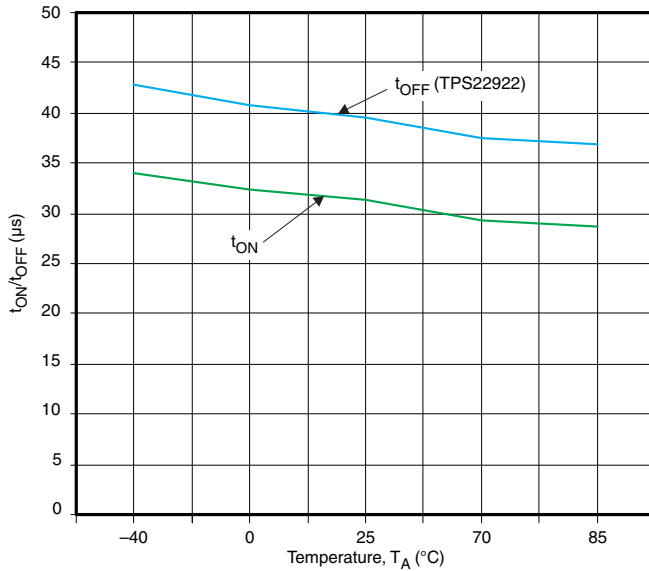

Figure 14. t_{ON}/t_{OFF} vs Temperature (V_{IN} = 3.3 V)

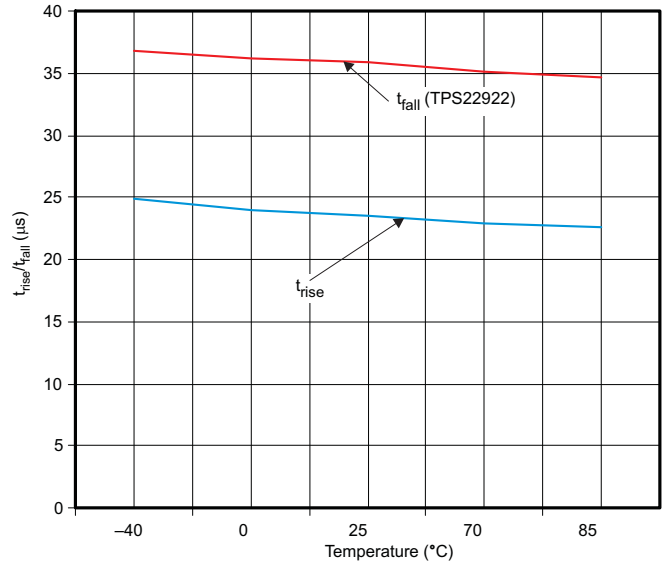

Figure 15. t_{rise}/t_{fall} vs Temperature (V_{IN} = 3.3 V)

TPS22922B

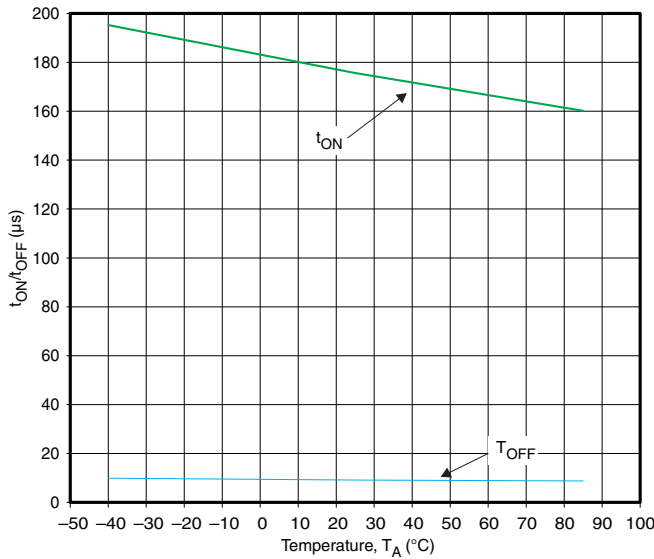

Figure 16. t_{ON}/t_{OFF} vs Temperature (V_{IN} = 3.3 V)

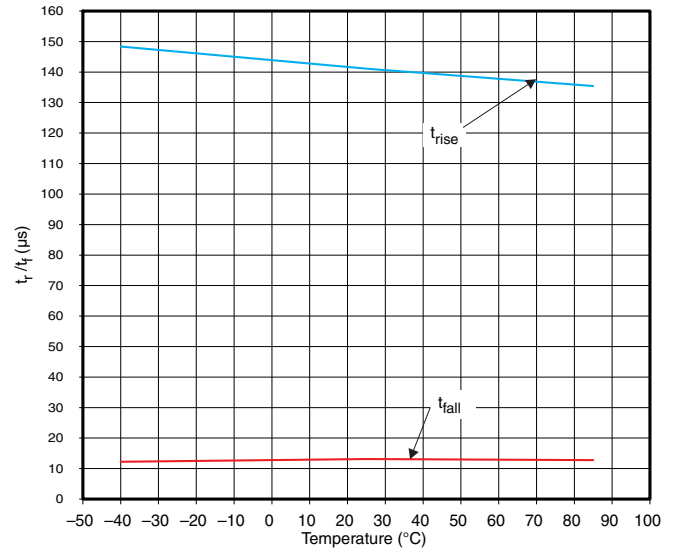

Figure 17. t_{rise}/t_{fall} vs Temperature (V_{IN} = 3.3 V)

TYPICAL CHARACTERISTICS (continued)

TPS22921 and TPS22922

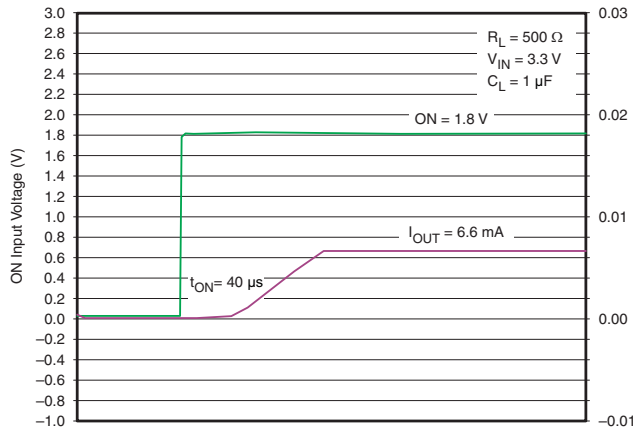

Figure 18. t_{ON} Response

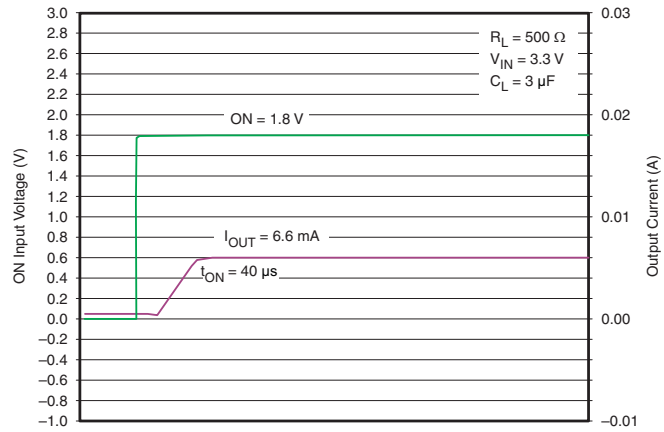

Figure 19. t_{ON} Response

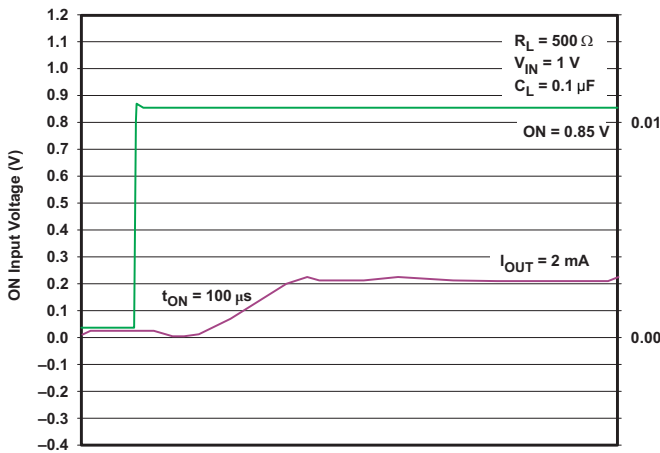

Figure 20. t_{ON} Response

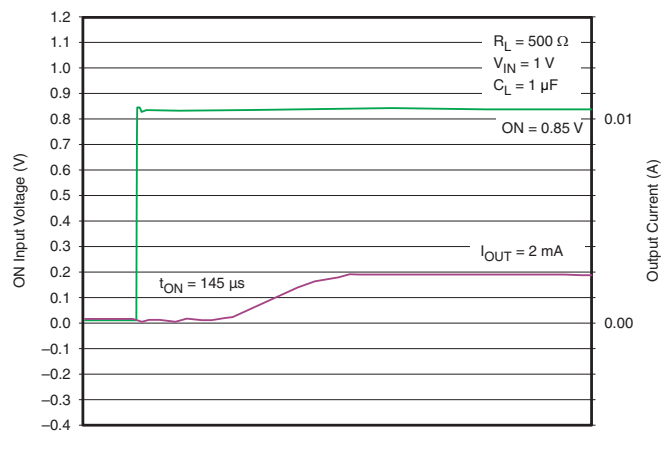

Figure 21. t_{ON} Response

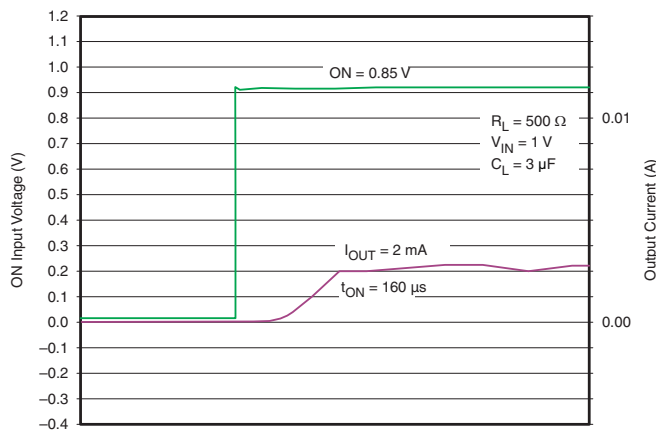

Figure 22. t_{ON} Response

TYPICAL CHARACTERISTICS (continued)

TPS22921

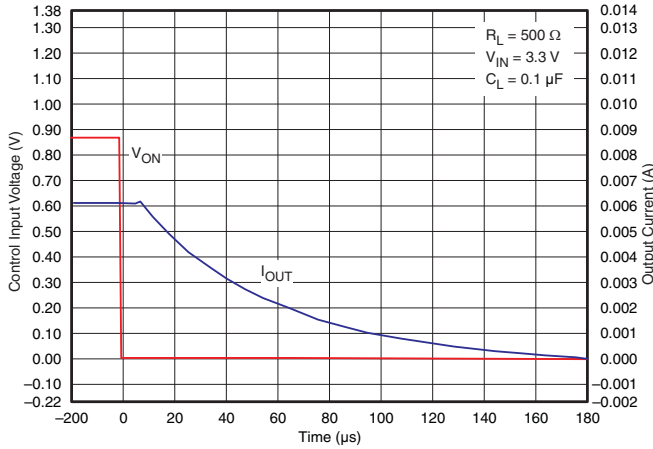

Figure 23. t_{OFF} Response

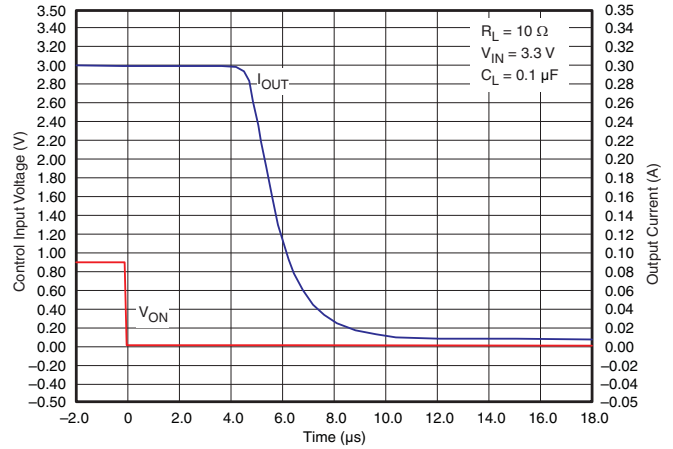

Figure 24. t_{OFF} Response

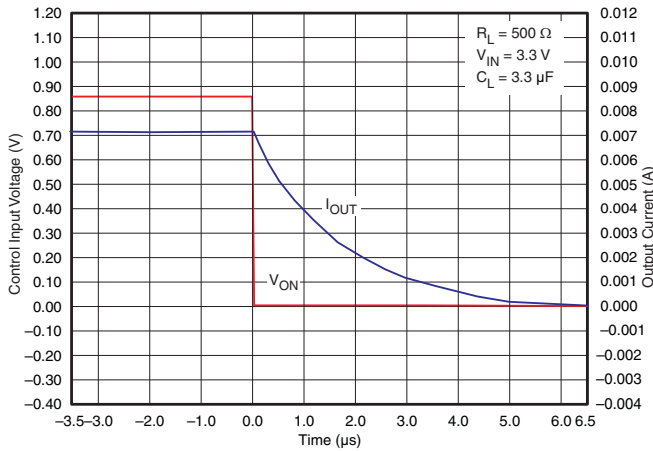

Figure 25. t_{OFF} Response

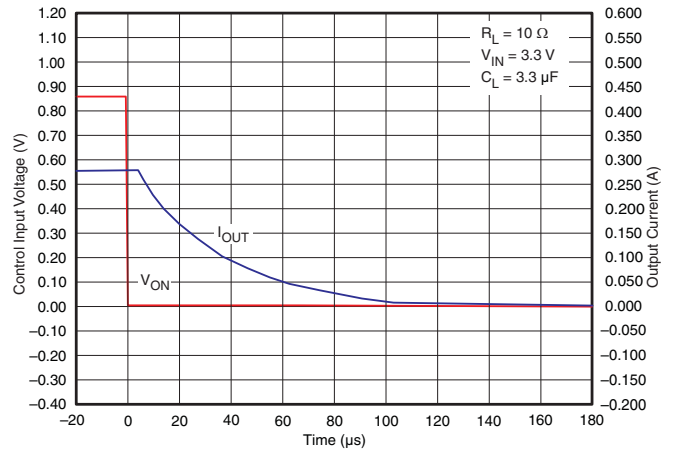

Figure 26. t_{OFF} Response

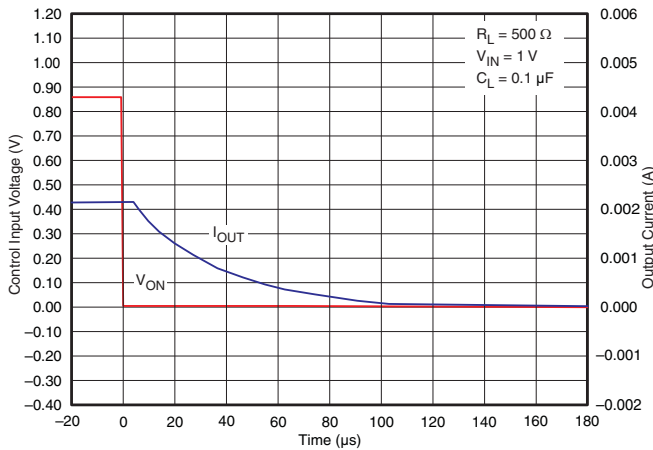

Figure 27. t_{OFF} Response

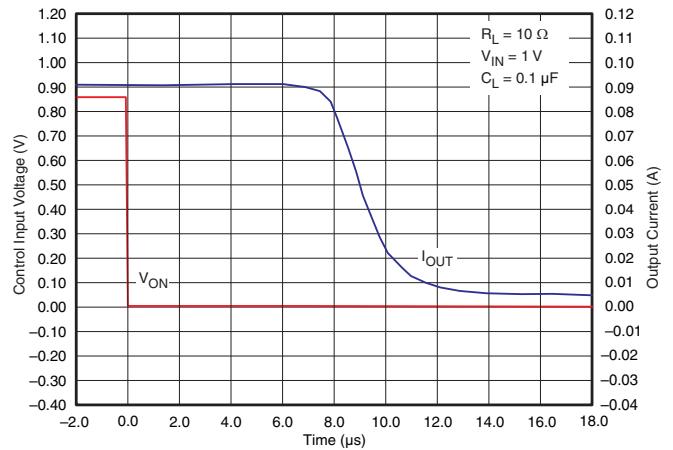

Figure 28. t_{OFF} Response

TYPICAL CHARACTERISTICS (continued)

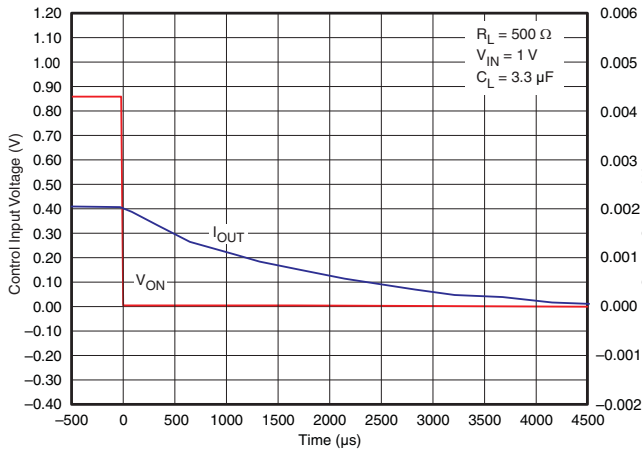

Figure 29. t_{OFF} Response

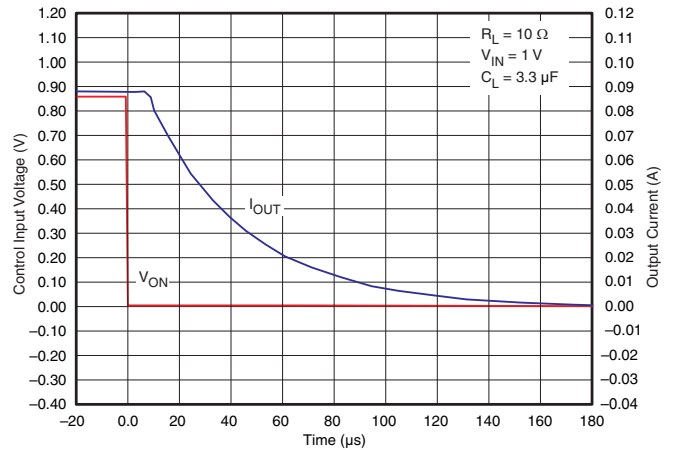

Figure 30. t_{OFF} Response

TPS22922

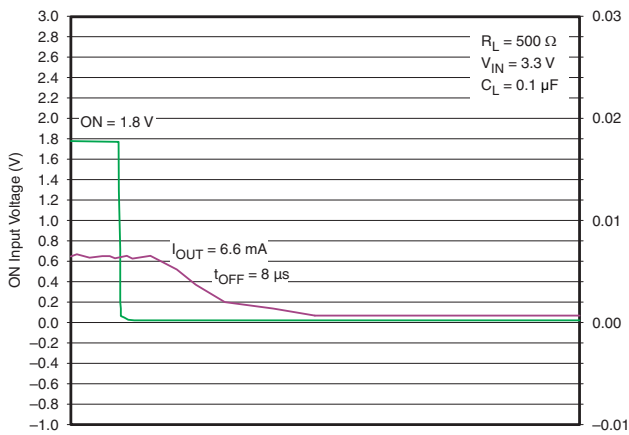

Figure 31. t_{OFF} Response

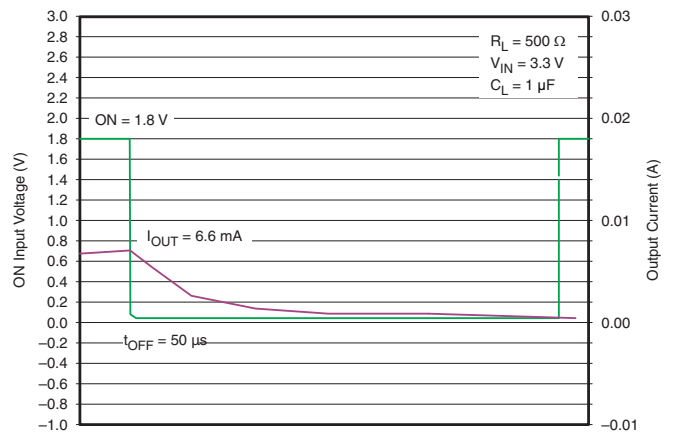

Figure 32. t_{OFF} Response

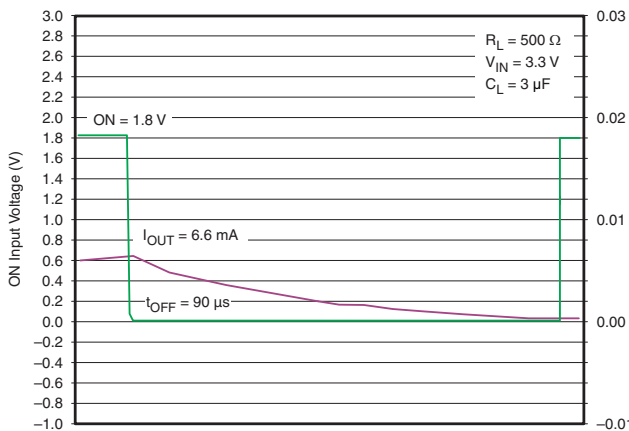

Figure 33. t_{OFF} Response

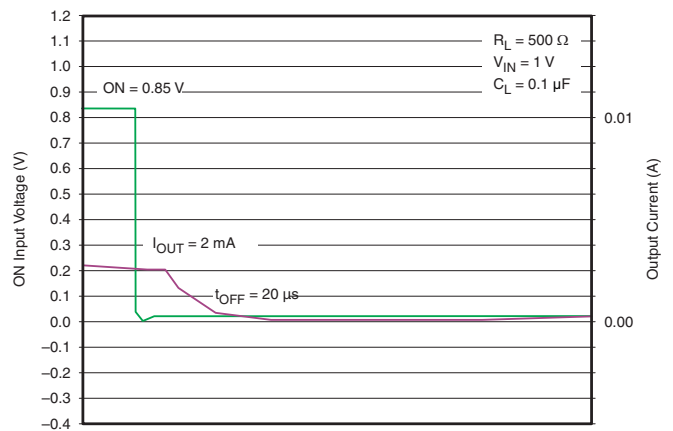

Figure 34. t_{OFF} Response

TYPICAL CHARACTERISTICS (continued)

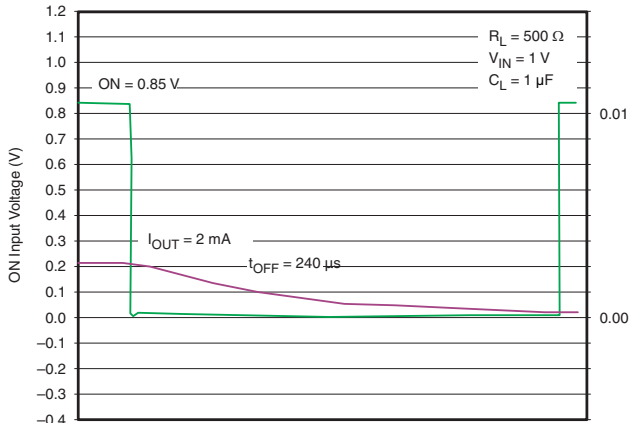

Figure 35. t_{OFF} Response

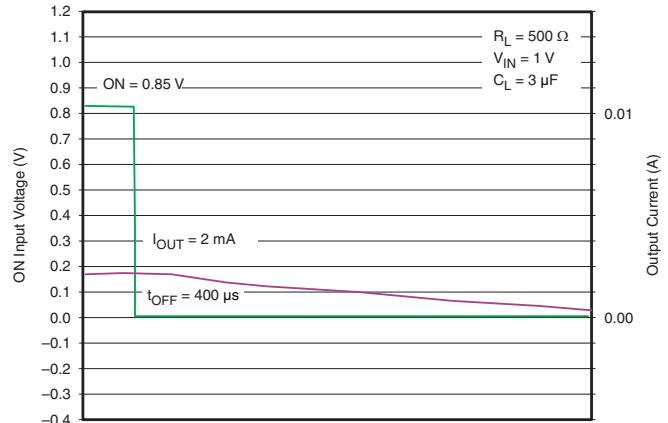

Figure 36. t_{OFF} Response

TPS22922B

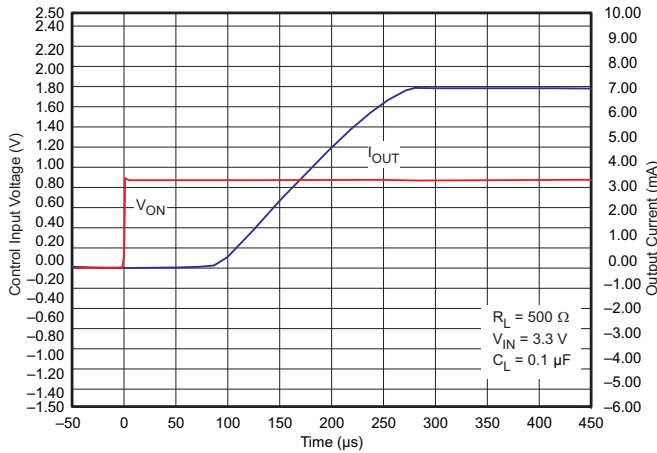

Figure 37. t_{ON} Response

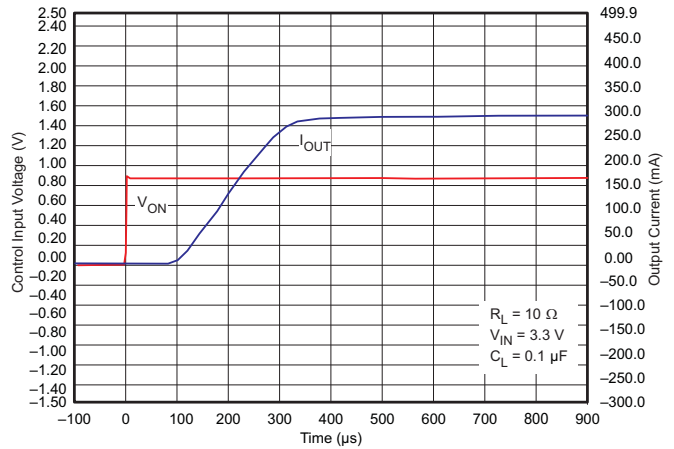

Figure 38. t_{ON} Response

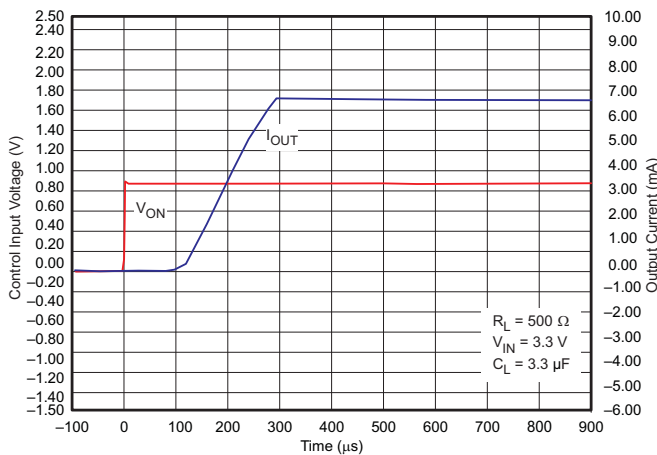

Figure 39. t_{ON} Response

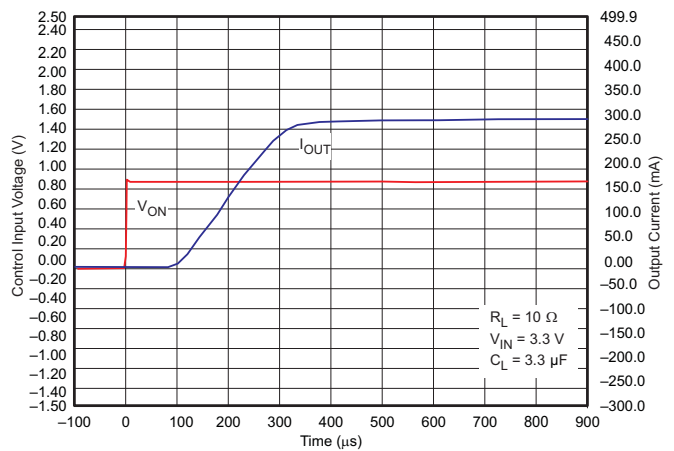

Figure 40. t_{ON} Response

TYPICAL CHARACTERISTICS (continued)

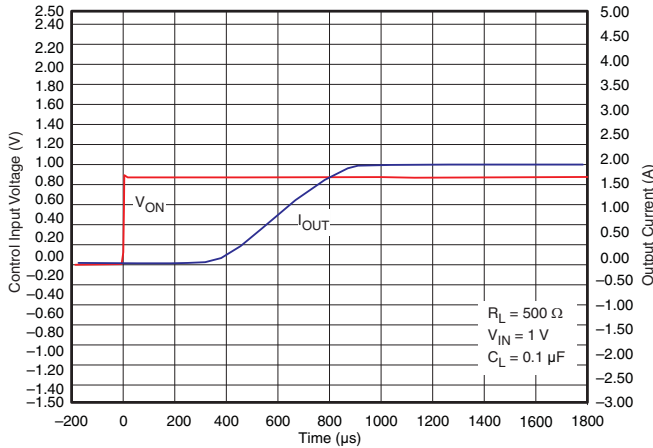

Figure 41. t_{ON} Response

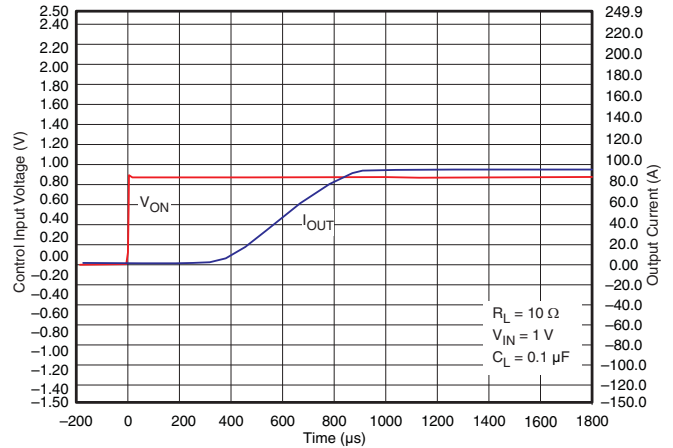

Figure 42. t_{ON} Response

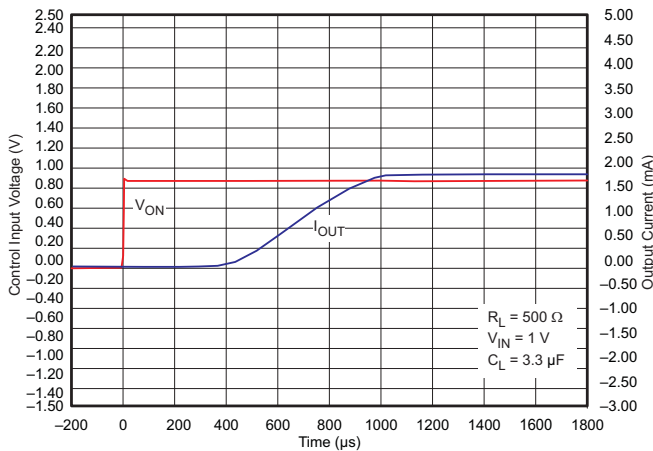

Figure 43. t_{ON} Response

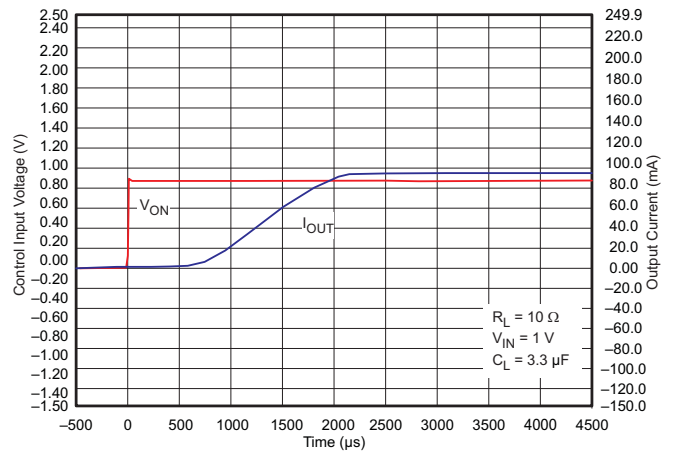

Figure 44. t_{ON} Response

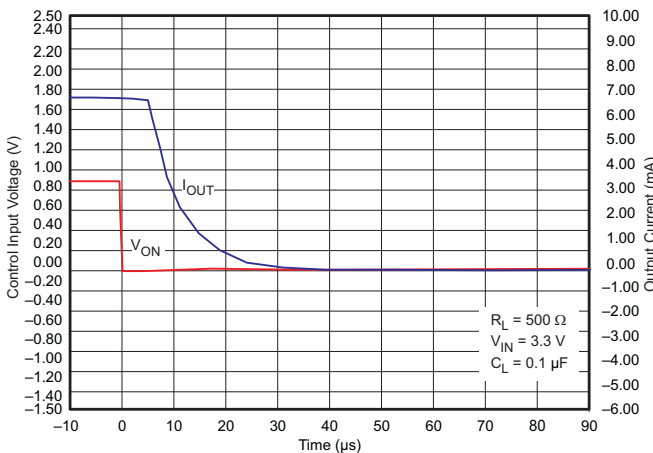

Figure 45. t_{OFF} Response

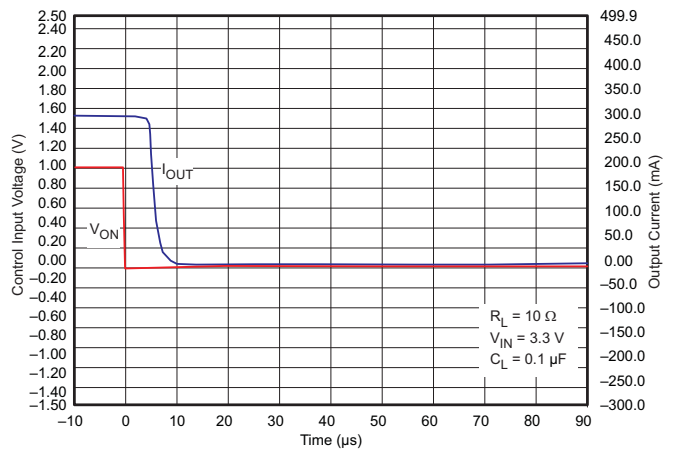

Figure 46. t_{OFF} Response

TYPICAL CHARACTERISTICS (continued)

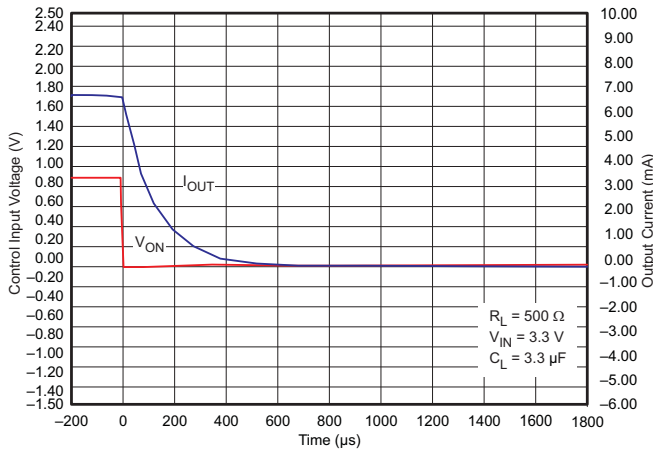

Figure 47. t_{OFF} Response

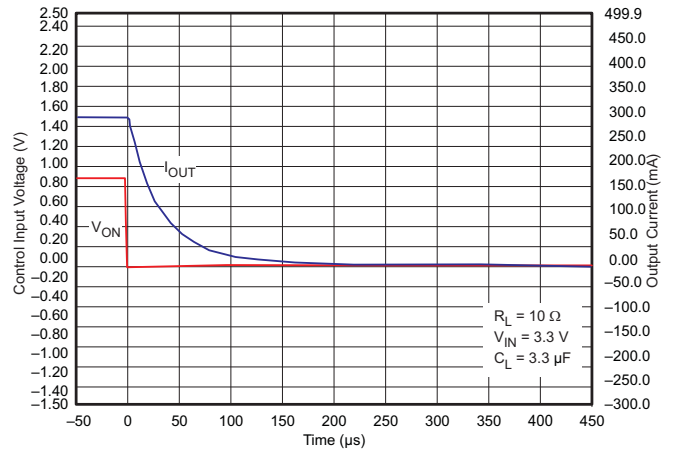

Figure 48. t_{OFF} Response

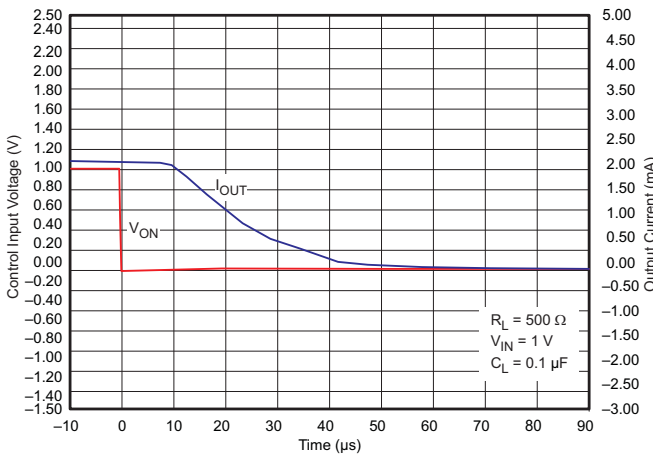

Figure 49. t_{OFF} Response

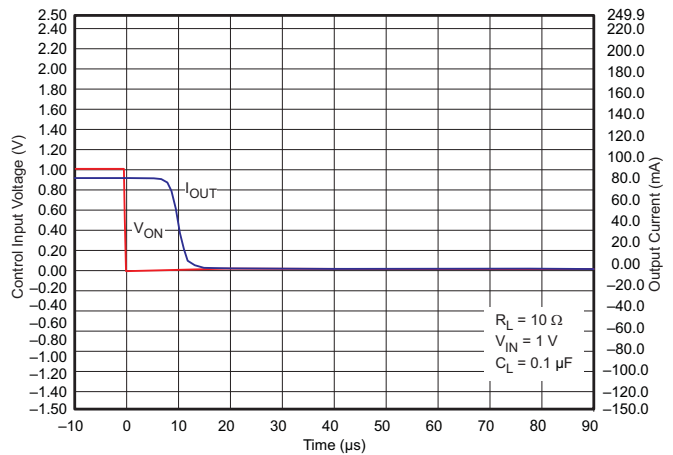

Figure 50. t_{OFF} Response

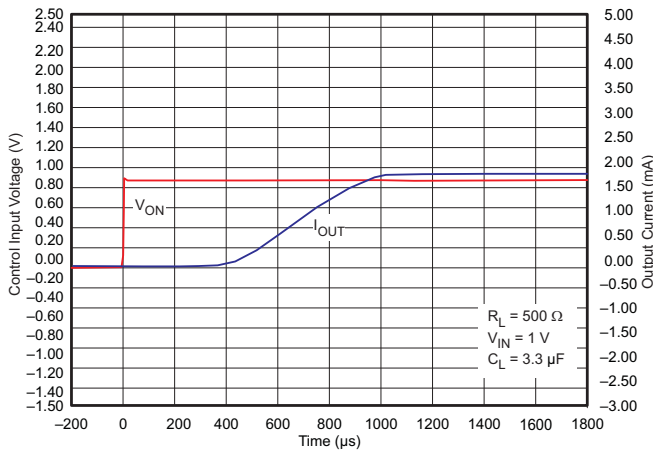

Figure 51. t_{OFF} Response

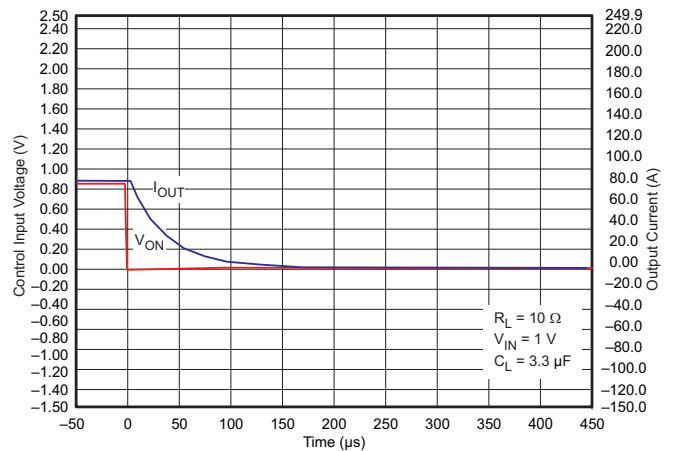
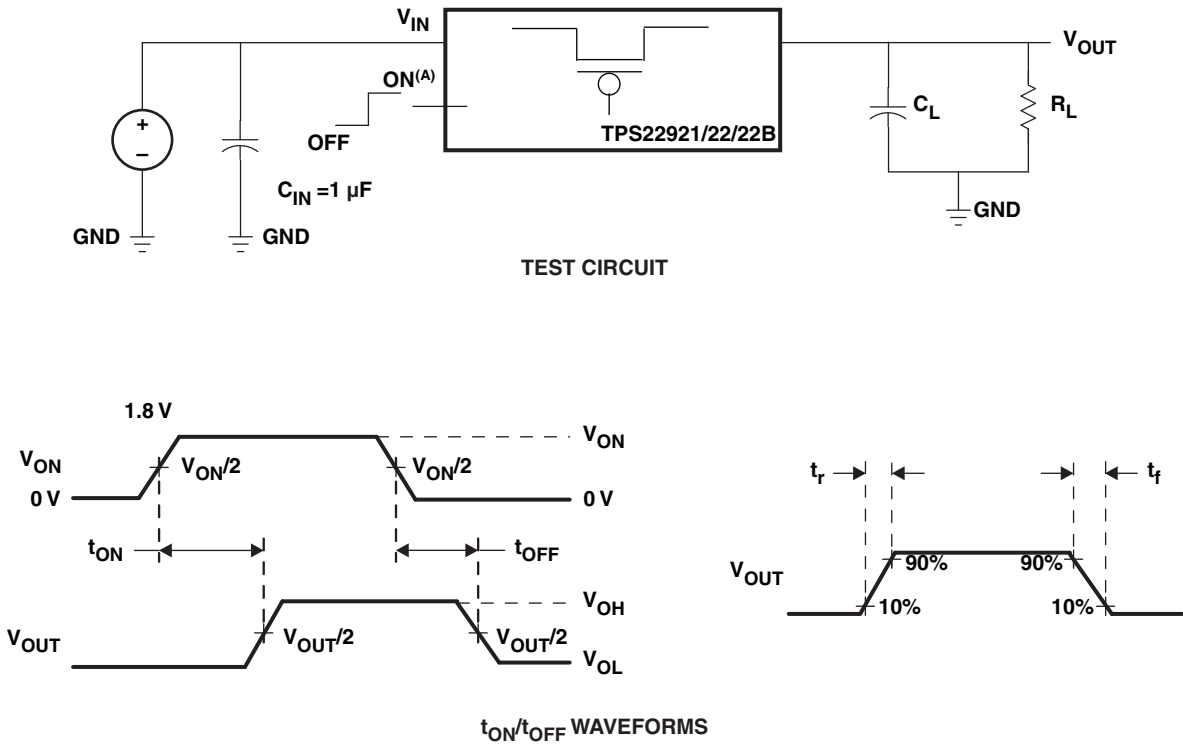

Figure 52. t_{OFF} Response

PARAMETER MEASUREMENT INFORMATION



A. t_{rise} and t_{fall} of the control signal is 100 ns.

Figure 53. Test Circuit and t_{ON}/t_{OFF} Waveforms

APPLICATION INFORMATION

ON/OFF Control

The ON pin controls the state of the switch. Activating ON continuously holds the switch in the on state so long as there is no fault. ON is active HI and has a low threshold making it capable of interfacing with low voltage signals. The ON pin is compatible with standard GPIO logic threshold. It can be used with any microcontroller with 1.2-V, 1.8-V, 2.5-V or 3.3-V GPIOs.

Input Capacitor

To limit the voltage drop on the input supply caused by transient in-rush currents when the switch turns on into a discharged load capacitor or short-circuit, a capacitor must be placed between V_{IN} and GND. A 1- μ F ceramic capacitor, C_{IN} , placed close to the pins is usually sufficient. Higher values of C_{IN} can be used to further reduce the voltage drop during higher current application. When switching a heavy load, it is recommended to have an input capacitor about 10 or more times higher than the output capacitor in order to avoid any supply drop.

Output Capacitor

Due to the integral body diode in the PMOS switch, a C_{IN} greater than C_L is highly recommended. A C_L greater than C_{IN} can cause V_{OUT} to exceed V_{IN} when the system supply is removed. This could result in current flow through the body diode from V_{OUT} to V_{IN} .

Board Layout

For best performance, all traces should be as short as possible. To be most effective, the input and output capacitors should be placed close to the device to minimize the effects that parasitic trace inductances may have on normal and short-circuit operation. Using wide traces for V_{IN} , V_{OUT} , and GND will help minimize the parasitic electrical effects along with minimizing the case to ambient thermal impedance.

PACKAGING INFORMATION

Orderable Device	Status ⁽¹⁾	Package Type	Package Drawing	Pins	Package Qty	Eco Plan ⁽²⁾	Lead/Ball Finish	MSL Peak Temp ⁽³⁾
TPS22921YFPR	ACTIVE	DSBGA	YFP	6	3000	Green (RoHS & no Sb/Br)	SNAGCU	Level-1-260C-UNLIM
TPS22921YZPR	ACTIVE	DSBGA	YZP	6	3000	Green (RoHS & no Sb/Br)	SNAGCU	Level-1-260C-UNLIM
TPS22922BYFPR	ACTIVE	DSBGA	YFP	6	3000	Green (RoHS & no Sb/Br)	SNAGCU	Level-1-260C-UNLIM
TPS22922BYZPR	ACTIVE	DSBGA	YZP	6	3000	Green (RoHS & no Sb/Br)	SNAGCU	Level-1-260C-UNLIM
TPS22922YFPR	ACTIVE	DSBGA	YFP	6	3000	Green (RoHS & no Sb/Br)	SNAGCU	Level-1-260C-UNLIM
TPS22922YZPR	ACTIVE	DSBGA	YZP	6	3000	Green (RoHS & no Sb/Br)	SNAGCU	Level-1-260C-UNLIM

⁽¹⁾ The marketing status values are defined as follows:

ACTIVE: Product device recommended for new designs.

LIFEBUY: TI has announced that the device will be discontinued, and a lifetime-buy period is in effect.

NRND: Not recommended for new designs. Device is in production to support existing customers, but TI does not recommend using this part in a new design.

PREVIEW: Device has been announced but is not in production. Samples may or may not be available.

OBSOLETE: TI has discontinued the production of the device.

⁽²⁾ Eco Plan - The planned eco-friendly classification: Pb-Free (RoHS), Pb-Free (RoHS Exempt), or Green (RoHS & no Sb/Br) - please check <http://www.ti.com/productcontent> for the latest availability information and additional product content details.

TBD: The Pb-Free/Green conversion plan has not been defined.

Pb-Free (RoHS): TI's terms "Lead-Free" or "Pb-Free" mean semiconductor products that are compatible with the current RoHS requirements for all 6 substances, including the requirement that lead not exceed 0.1% by weight in homogeneous materials. Where designed to be soldered at high temperatures, TI Pb-Free products are suitable for use in specified lead-free processes.

Pb-Free (RoHS Exempt): This component has a RoHS exemption for either 1) lead-based flip-chip solder bumps used between the die and package, or 2) lead-based die adhesive used between the die and leadframe. The component is otherwise considered Pb-Free (RoHS compatible) as defined above.

Green (RoHS & no Sb/Br): TI defines "Green" to mean Pb-Free (RoHS compatible), and free of Bromine (Br) and Antimony (Sb) based flame retardants (Br or Sb do not exceed 0.1% by weight in homogeneous material)

⁽³⁾ MSL, Peak Temp. -- The Moisture Sensitivity Level rating according to the JEDEC industry standard classifications, and peak solder temperature.

Important Information and Disclaimer:The information provided on this page represents TI's knowledge and belief as of the date that it is provided. TI bases its knowledge and belief on information provided by third parties, and makes no representation or warranty as to the accuracy of such information. Efforts are underway to better integrate information from third parties. TI has taken and continues to take reasonable steps to provide representative and accurate information but may not have conducted destructive testing or chemical analysis on incoming materials and chemicals. TI and TI suppliers consider certain information to be proprietary, and thus CAS numbers and other limited information may not be available for release.

In no event shall TI's liability arising out of such information exceed the total purchase price of the TI part(s) at issue in this document sold by TI to Customer on an annual basis.

TAPE AND REEL INFORMATION

QUADRANT ASSIGNMENTS FOR PIN 1 ORIENTATION IN TAPE

*All dimensions are nominal

Device	Package Type	Package Drawing	Pins	SPQ	Reel Diameter (mm)	Reel Width W1 (mm)	A0 (mm)	B0 (mm)	K0 (mm)	P1 (mm)	W (mm)	Pin1 Quadrant
TPS22921YFPR	DSBGA	YFP	6	3000	180.0	8.4	0.89	1.29	0.62	4.0	8.0	Q1
TPS22921YZPR	DSBGA	YZP	6	3000	180.0	8.4	1.02	1.52	0.63	4.0	8.0	Q1
TPS22922BYZPR	DSBGA	YZP	6	3000	180.0	8.4	1.02	1.52	0.63	4.0	8.0	Q1
TPS22922YZPR	DSBGA	YZP	6	3000	180.0	8.4	1.02	1.52	0.63	4.0	8.0	Q1

TAPE AND REEL BOX DIMENSIONS

*All dimensions are nominal

Device	Package Type	Package Drawing	Pins	SPQ	Length (mm)	Width (mm)	Height (mm)
TPS22921YFPR	DSBGA	YFP	6	3000	190.5	212.7	31.8
TPS22921YZPR	DSBGA	YZP	6	3000	220.0	220.0	34.0
TPS22922BYZPR	DSBGA	YZP	6	3000	220.0	220.0	34.0
TPS22922YZPR	DSBGA	YZP	6	3000	220.0	220.0	34.0

YZP (R-XBGA-N6)

DIE-SIZE BALL GRID ARRAY

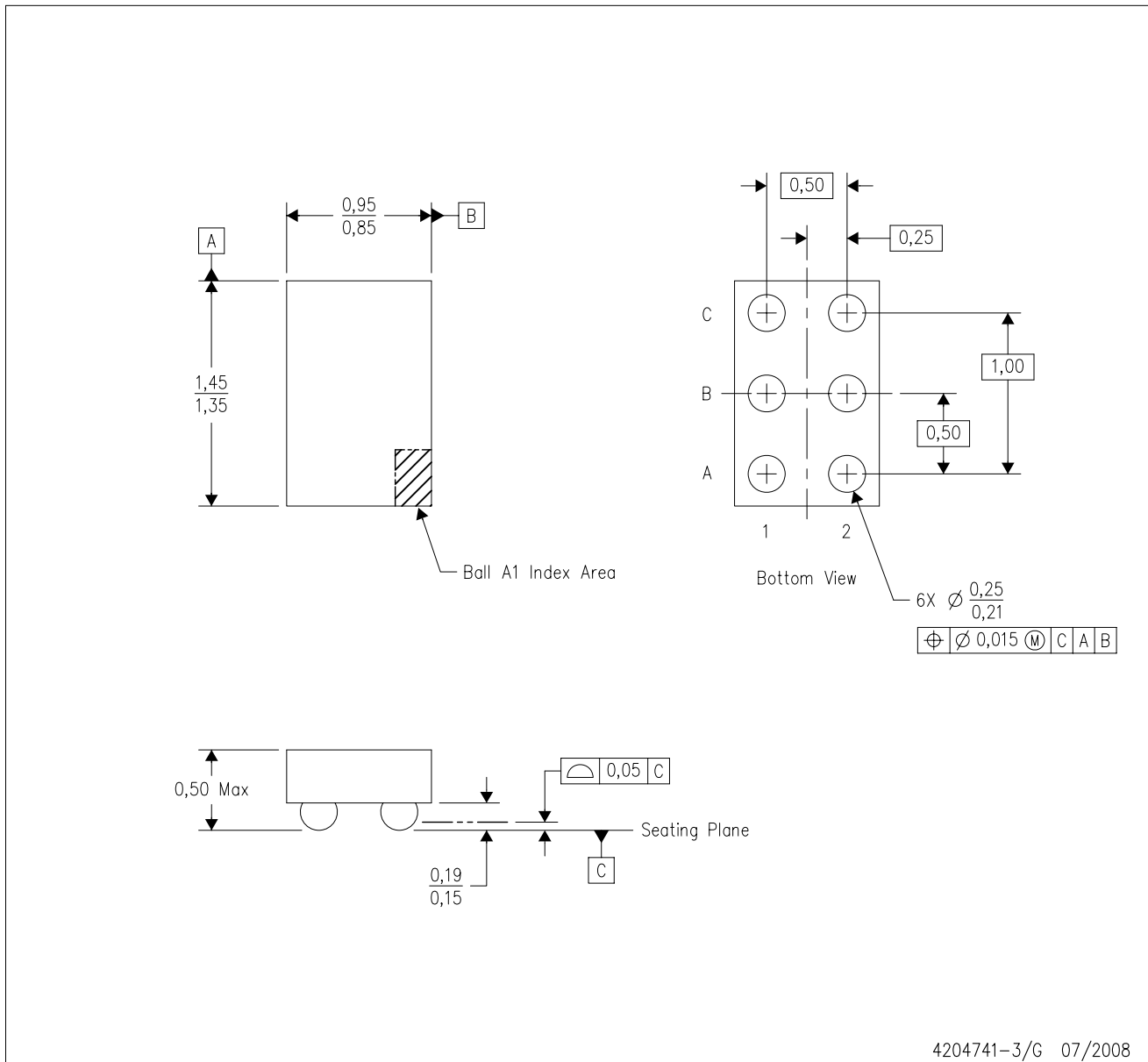

- NOTES:
- A. All linear dimensions are in millimeters. Dimensioning and tolerancing per ASME Y14.5M-1994.
 - B. This drawing is subject to change without notice.
 - C. NanoFree™ package configuration.
 - D. This package is lead-free. Refer to the 6 YEP package (drawing 4204725) for tin-lead (SnPb).

NanoFree is a trademark of Texas Instruments.



www.BDTC.com/TI

YFP (R-XBGA-N6)

DIE-SIZE BALL GRID ARRAY

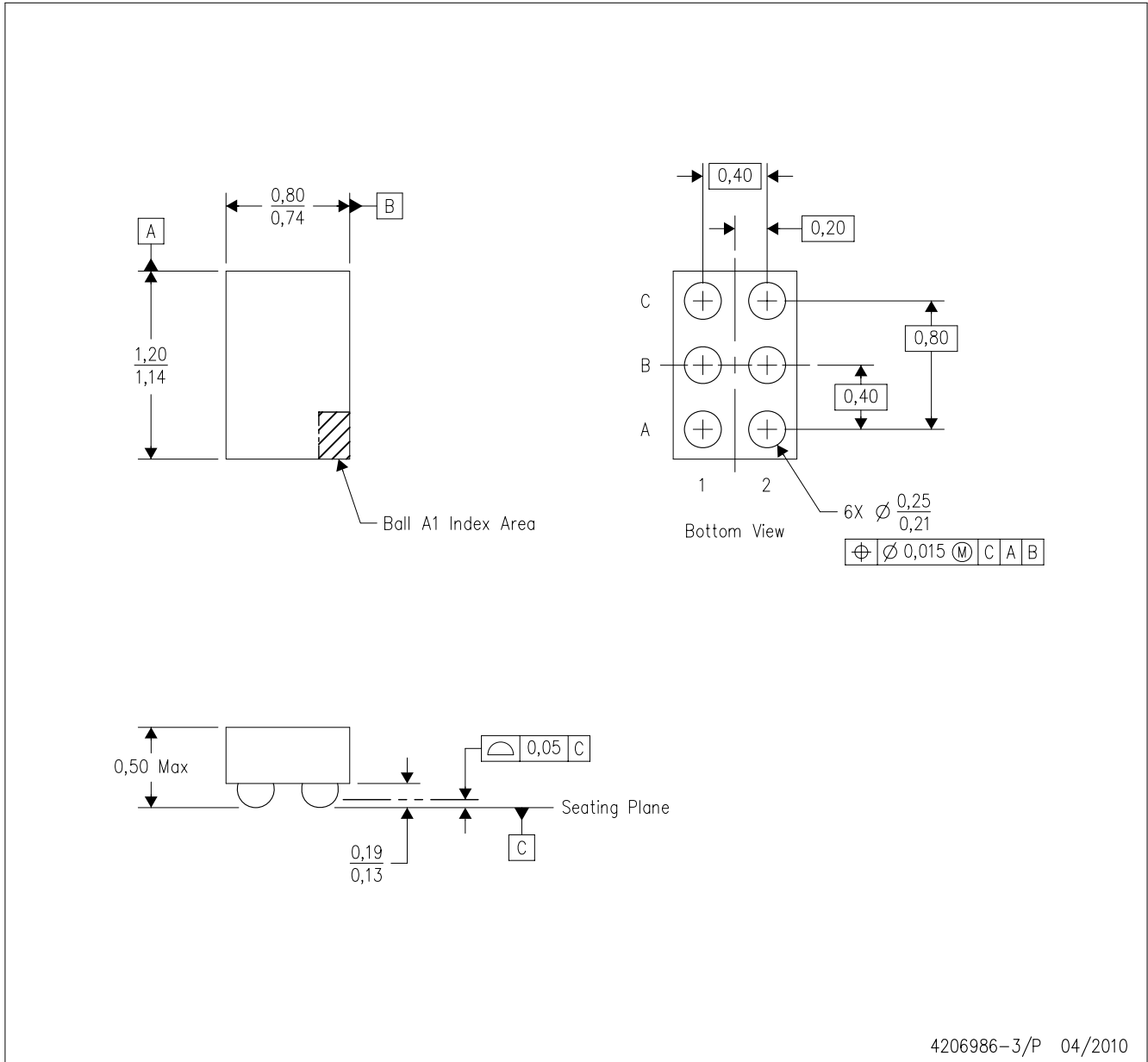

- NOTES:
- A. All linear dimensions are in millimeters. Dimensioning and tolerancing per ASME Y14.5M-1994.
 - B. This drawing is subject to change without notice.
 - C. NanoFree™ package configuration.
 - D. This is a Pb-free solder ball design.

NanoFree is a trademark of Texas Instruments.



www.BDTC.com/TI

IMPORTANT NOTICE

Texas Instruments Incorporated and its subsidiaries (TI) reserve the right to make corrections, modifications, enhancements, improvements, and other changes to its products and services at any time and to discontinue any product or service without notice. Customers should obtain the latest relevant information before placing orders and should verify that such information is current and complete. All products are sold subject to TI's terms and conditions of sale supplied at the time of order acknowledgment.

TI warrants performance of its hardware products to the specifications applicable at the time of sale in accordance with TI's standard warranty. Testing and other quality control techniques are used to the extent TI deems necessary to support this warranty. Except where mandated by government requirements, testing of all parameters of each product is not necessarily performed.

TI assumes no liability for applications assistance or customer product design. Customers are responsible for their products and applications using TI components. To minimize the risks associated with customer products and applications, customers should provide adequate design and operating safeguards.

TI does not warrant or represent that any license, either express or implied, is granted under any TI patent right, copyright, mask work right, or other TI intellectual property right relating to any combination, machine, or process in which TI products or services are used. Information published by TI regarding third-party products or services does not constitute a license from TI to use such products or services or a warranty or endorsement thereof. Use of such information may require a license from a third party under the patents or other intellectual property of the third party, or a license from TI under the patents or other intellectual property of TI.

Reproduction of TI information in TI data books or data sheets is permissible only if reproduction is without alteration and is accompanied by all associated warranties, conditions, limitations, and notices. Reproduction of this information with alteration is an unfair and deceptive business practice. TI is not responsible or liable for such altered documentation. Information of third parties may be subject to additional restrictions.

Resale of TI products or services with statements different from or beyond the parameters stated by TI for that product or service voids all express and any implied warranties for the associated TI product or service and is an unfair and deceptive business practice. TI is not responsible or liable for any such statements.

TI products are not authorized for use in safety-critical applications (such as life support) where a failure of the TI product would reasonably be expected to cause severe personal injury or death, unless officers of the parties have executed an agreement specifically governing such use. Buyers represent that they have all necessary expertise in the safety and regulatory ramifications of their applications, and acknowledge and agree that they are solely responsible for all legal, regulatory and safety-related requirements concerning their products and any use of TI products in such safety-critical applications, notwithstanding any applications-related information or support that may be provided by TI. Further, Buyers must fully indemnify TI and its representatives against any damages arising out of the use of TI products in such safety-critical applications.

TI products are neither designed nor intended for use in military/aerospace applications or environments unless the TI products are specifically designated by TI as military-grade or "enhanced plastic." Only products designated by TI as military-grade meet military specifications. Buyers acknowledge and agree that any such use of TI products which TI has not designated as military-grade is solely at the Buyer's risk, and that they are solely responsible for compliance with all legal and regulatory requirements in connection with such use.

TI products are neither designed nor intended for use in automotive applications or environments unless the specific TI products are designated by TI as compliant with ISO/TS 16949 requirements. Buyers acknowledge and agree that, if they use any non-designated products in automotive applications, TI will not be responsible for any failure to meet such requirements.

Following are URLs where you can obtain information on other Texas Instruments products and application solutions:

Products		Applications	
Amplifiers	amplifier.ti.com	Audio	www.ti.com/audio
Data Converters	dataconverter.ti.com	Automotive	www.ti.com/automotive
DLP® Products	www.dlp.com	Communications and Telecom	www.ti.com/communications
DSP	dsp.ti.com	Computers and Peripherals	www.ti.com/computers
Clocks and Timers	www.ti.com/clocks	Consumer Electronics	www.ti.com/consumer-apps
Interface	interface.ti.com	Energy	www.ti.com/energy
Logic	logic.ti.com	Industrial	www.ti.com/industrial
Power Mgmt	power.ti.com	Medical	www.ti.com/medical
Microcontrollers	microcontroller.ti.com	Security	www.ti.com/security
RFID	www.ti-rfid.com	Space, Avionics & Defense	www.ti.com/space-avionics-defense
RF/IF and ZigBee® Solutions	www.ti.com/lprf	Video and Imaging	www.ti.com/video
		Wireless	www.ti.com/wireless-apps

Mailing Address: Texas Instruments, Post Office Box 655303, Dallas, Texas 75265
Copyright © 2010, Texas Instruments Incorporated

www.BDTIC.com/TI