

## CURRENT-LIMITED LOAD SWITCH WITH LOW NOISE REGULATION CAPABILITY

Check for Samples: [TPS22949](#), [TPS22949A](#)

### FEATURES

- **Integrated Current Limiter**
  - **Input Voltage Range: 1.62 V to 4.5 V**
  - **Low ON-Resistance**
    - $r_{ON} = 300\text{-m}\Omega$  at  $V_{IN} = 4.5\text{ V}$
    - $r_{ON} = 350\text{-m}\Omega$  at  $V_{IN} = 3.3\text{ V}$
    - $r_{ON} = 400\text{-m}\Omega$  at  $V_{IN} = 2.5\text{ V}$
    - $r_{ON} = 600\text{-m}\Omega$  at  $V_{IN} = 1.8\text{ V}$
  - **Integrated 100-mA Minimum Current Limit**
  - **Undervoltage Lockout**
  - **Fast-Current Limit Response Time**
  - **Integrated Fault Blanking and Auto Restart**
- **Stable Without Current Limiter Output Capacitor (TPS22949A Only)**
- **Integrated Low-Noise RF LDO**
  - **Input Voltage Range: 1.62 V to 4.5 V**
  - **Low Noise: 50  $\mu\text{Vrms}$  (10 Hz to 100 kHz)**
  - **80-dB  $V_{IN}$  PSRR (10 Hz to 10 kHz)**
  - **Fast Start-Up Time: 130  $\mu\text{s}$**
  - **Low Dropout 100 mV at  $I_{load} = 100\text{ mA}$**
  - **Integrated Output Discharge**
  - **Stable With 2.2- $\mu\text{F}$  Output Capacitor**
- **1.8-V Compatible Control Input Threshold**
- **ESD Performance Tested Per JESD 22**
  - **3500-V Human-Body Model (A114-B, Class II)**
  - **1000-V Charged-Device Model (C101)**
- **Tiny 8-Terminal YZP Package (1.9 mm  $\times$  0.9 mm, 0.5-mm Pitch, 0.5-mm Height) and SON-8 (DRG) 3.0 mm  $\times$  3.0 mm**

### APPLICATIONS

- **Fingerprint Module Protection**
- **Portable Consumer Electronics**
- **Smart Phone**
- **Notebooks**
- **Control Access Systems**

### DESCRIPTION

The TPS22949 and TPS22949A are devices that provides protection to systems and loads in high-current conditions. The device contains a 500-m $\Omega$  current-limited P-channel MOSFET that can operate over an input voltage range of 1.62 V to 4.5 V as well as a low-dropout (LDO) regulator with a fixed output voltage of 1.8 V.

The switch is controlled by an on/off input (EN1), which is capable of interfacing directly with low-voltage control signals. When the switch current reaches the maximum limit, the TPS22949/TPS22949A operates in a constant-current mode to prohibit excessive currents from causing damage. If the constant current condition still persists after 12 ms, these devices shut off the switch and pull the fault signal pin (OC) low. The TPS22949/TPS22949A has an auto-restart feature that turns the switch on again after 70 ms if the EN1 pin is still active.

The output of the current limiter is internally connected to a RF low-dropout (LDO) regulator that offers good ac performance with very low ground current, good power-supply rejection ratio (PSRR), low noise, fast start-up, and excellent line and load transient response. The output of the regulator is stable with ceramic capacitors. This LDO uses a precision voltage reference and feedback loop to achieve overall accuracy of 2% over all load, line, process, and temperature variations.

The TPS22949A integrates additional internal circuitry that increases the current limit of the switch during the power-up sequence. This feature allows the TPS22949A to operate without a storage capacitor at the input of the LDO.

The TPS22949 and TPS22949A are available in a space-saving 8-terminal WCSP (YZP) or in a 8-pin SON package (DRG). Both are characterized for operation over the free-air temperature range of  $-40^{\circ}\text{C}$  to  $85^{\circ}\text{C}$ .



Please be aware that an important notice concerning availability, standard warranty, and use in critical applications of Texas Instruments semiconductor products and disclaimers thereto appears at the end of this data sheet.

**ORDERING INFORMATION<sup>(1)</sup>**

T <sub>A</sub>	PACKAGE <sup>(2)</sup>		ORDERABLE PART NUMBER	TOP-SIDE MARKING <sup>(3)</sup>
-40°C to 85°C	SON – DRG	Tape and reel	TPS22949ADRGR	ZUG
	WCSP – YZP	Tape and reel	TPS22949YZPR	___4Y_
			TPS22949AYZPR	___4Z_

- (1) For the most current package and ordering information, see the Package Option Addendum at the end of this document, or see the TI web site at [www.ti.com](http://www.ti.com).
- (2) Package drawings, thermal data, and symbolization are available at [www.ti.com/packaging](http://www.ti.com/packaging).
- (3) YZP: The actual top-side marking has three preceding characters to denote year, month, and sequence code, and one following character to designate the wafer fab/assembly site. Pin 1 identifier indicates solder-bump composition (1 = SnPb, • = Pb-free).

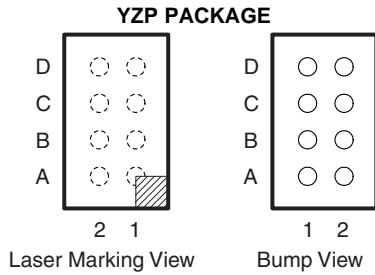

**Table 1. YZP PACKAGE TERMINAL ASSIGNMENTS**

<b>D</b>	EN1	OC
<b>C</b>	V <sub>IN</sub>	V <sub>OUTCL</sub>
<b>B</b>	GND	V <sub>OUTLDO</sub>
<b>A</b>	EN2	V <sub>+</sub>
	<b>2</b>	<b>1</b>

**DRG PACKAGE  
(TOP VIEW)**

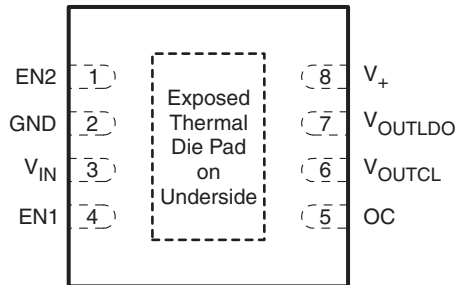

The exposed center pad, if used, must be connected as a secondary GND or left electrically open.

**TERMINAL FUNCTIONS**

TERMINAL NO.		NAME	DESCRIPTION
YZP	DRG		
A1	8	V <sub>+</sub>	Supply voltage
A2	1	EN2	LDO control input. Active high. Do not leave floating.
B1	7	V <sub>OUTLDO</sub>	LDO output. Output of the RF LDO fixed to 1.8 V <sup>(1)</sup> .
B2	2	GND	Ground
C1	6	V <sub>OUTCL</sub>	Switch output. Output of the power switch
C2	3	V <sub>IN</sub>	Supply input. Input to the power switch; bypass this input with a ceramic capacitor to ground.
D1	5	OC	Over current output flag. Active low, open-drain output that indicates an over-current, supply undervoltage, or over-temperature state.
D2	4	EN1	Power switch control input. Active high. Do not leave floating.

- (1) Output voltages from 0.9 V to 3.6 V in 50-mV increments are available through the use of innovative factory EEPROM programming; minimum order quantities may apply. Contact factory for details and availability.

FUNCTION TABLE

STATE OF THE DEVICE	EN1	EN2
Current limiter and LDO disabled	0	X
Current limiter enabled/LDO disabled	1	0
Current limiter and LDO enabled	1	1

TYPICAL APPLICATIONS

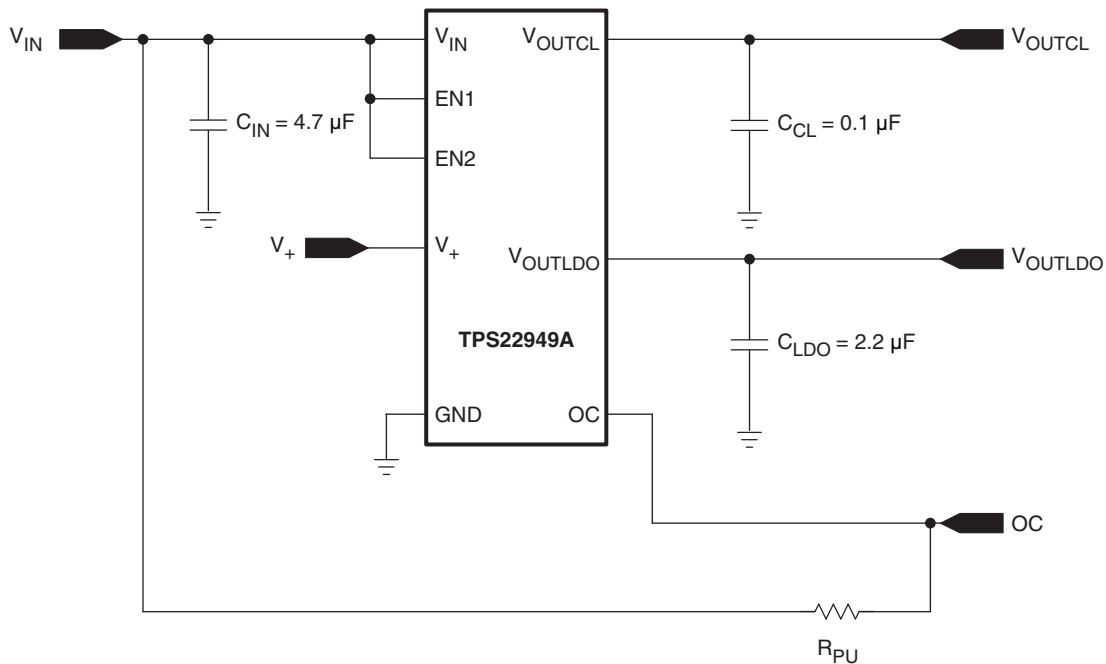
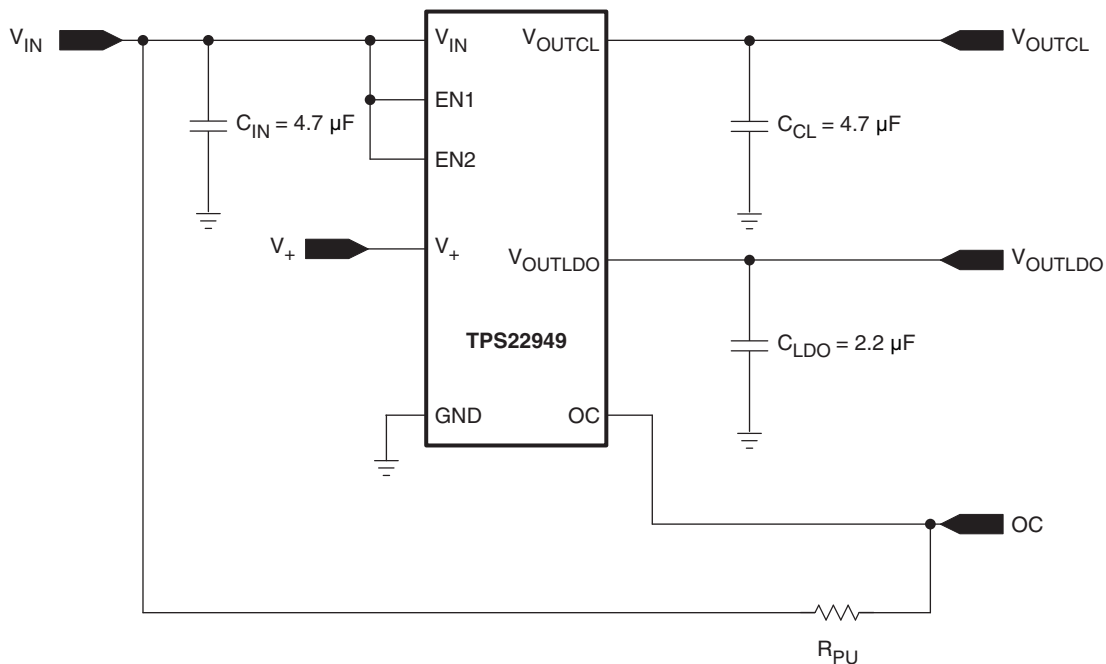

BLOCK DIAGRAMS

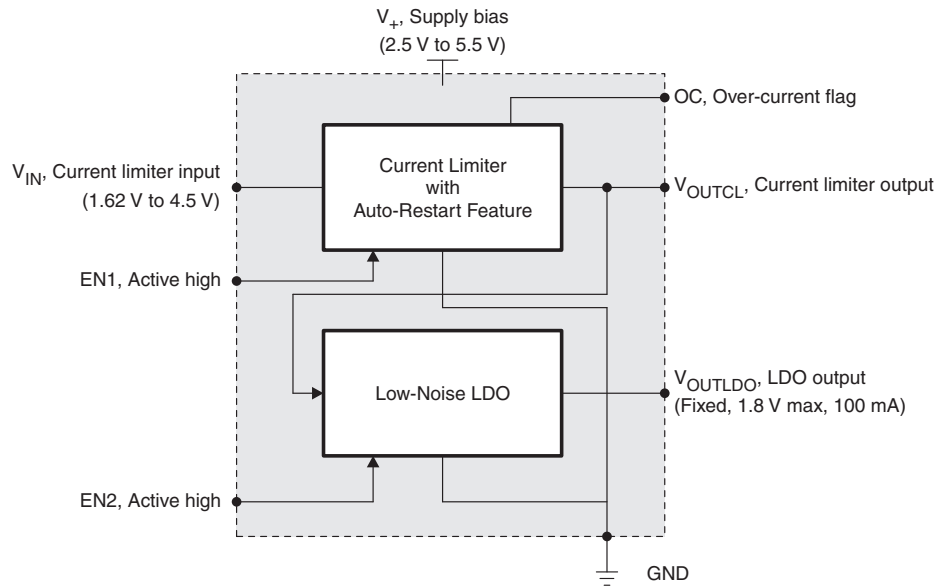

Figure 1. Simplified Block Diagram

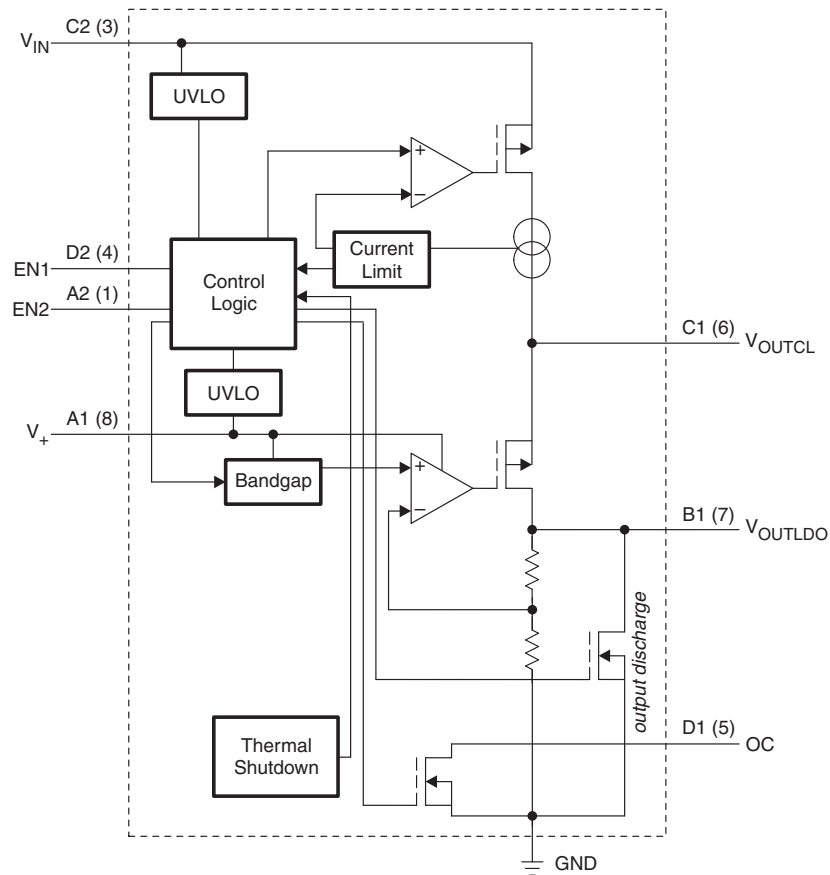

Figure 2. Detailed Block Diagram

**ABSOLUTE MAXIMUM RATINGS<sup>(1)</sup>**

			MIN	MAX	UNIT
$V_I$	Input voltage	$V_{IN}, EN1, EN2, V_+$	-0.3	6	V
$V_{OUTCL}$	Current limiter output voltage			$V_{IN} + 0.3$	V
$T_J$	Operating junction temperature range		-40	105	°C
$T_{stg}$	Storage temperature range		-65	150	°C
	Electrostatic discharge protection (ESD)	Human-Body Model		3.5	kV
		Charged-Device Model		1	

(1) Stresses beyond those listed under absolute maximum ratings may cause permanent damage to the device. These are stress ratings only, and functional operation of the device at these or any other conditions beyond those indicated under *Recommended Operating Conditions* is not implied. Exposure to absolute-maximum-rated conditions for extended periods may affect device reliability.

**DISSIPATION RATINGS**

BOARD	PACKAGE	R $\theta$ JC	R $\theta$ JA	DERATING FACTOR ABOVE			
				T <sub>A</sub> = 25°C	T <sub>A</sub> < 25°C	T <sub>A</sub> = 70°C	T <sub>A</sub> = 85°C
High-K (JESD 51-7)	YZP	13.79°C/W	101.92°C/W	98.1 mW/°C	784 mW	343 mW	196 mW
High-K (JESD 51-5)	DRG	56.6°C/W	52.44°C/W	19 mW/°C	1525 mW	667 mW	381 mW

**RECOMMENDED OPERATING CONDITIONS**

		MIN	MAX	UNIT
$V_{IN}$	Input voltage <sup>(1)</sup>	1.62	4.5	V
$V_{OUTCL}$	Current limiter output voltage		$V_{IN}$	V
$V_+$	Supply voltage	2.6	5.5	V
$C_{IN}$	Input capacitor	1		μF
$T_A$	Ambient free-air temperature	-40	85	°C
<b>Control Inputs (EN1, EN2)</b>				
$V_{IH}$	High-level input voltage	1.4	5.5	V
$V_{IL}$	Low-level input voltage		0.4	V

(1) See the [Application Information](#) section

**ELECTRICAL CHARACTERISTICS**

T<sub>A</sub> = -40°C to 85°C (unless otherwise noted)

PARAMETER	TEST CONDITIONS	MIN	TYP <sup>(1)</sup>	MAX	UNIT
$I_{GND}$	Ground pin current EN1 and EN2 = $V_+$ $V_+ = V_{OUT} + 1.4$ V or 2.5, whichever > 5.5 V, $V_{OUTCL} \geq V_{OUTLDO} + 0.5$ V $I_{OUT2} = 0$ mA		85	110	μA
$I_{GNDCL}$	Ground pin current (current limiter only)		40	75	μA
$I_{GND(OFF)}$	OFF-state ground pin current EN1 and EN2 = GND, $V_{OUTCL} = \text{Open}$ , $V_{OUTLDO} = \text{Open}$			2 6	μA
$I_{EN2}$	Enable pin 2 current, enabled VEN2 = $V_+ = 5.5$ V, $V_{IN} = 4.5$ V			1	μA
$I_{EN1}$	Enable pin 1 current, enabled VEN1 = $V_+ = 5.5$ V, $V_{IN} = 4.5$ V			1	μA
Thermal shutdown	Shutdown threshold (T <sub>A</sub> )	TPS22949		122	°C
		TPS22949A		135	
	Return from shutdown	TPS22949		112	
		TPS22949A		120	
Hysteresis	TPS22949		10		
	TPS22949A		10		

(1) Typical values are at  $V_{IN} = 3.3$  V and T<sub>A</sub> = 25°C.

### CURRENT LIMITER ELECTRICAL CHARACTERISTICS

over operating free-air temperature range,  $V_+ = 3.3\text{ V}$ ,  $EN1 = V_+$ ,  $EN2 = \text{GND}$  (unless otherwise noted)

PARAMETER	TEST CONDITIONS	$T_A$	YZP PACKAGE			DRG PACKAGE			UNIT		
			MIN	TYP	MAX	MIN	TYP	MAX			
$r_{ON}$	ON-state resistance	$I_{OUT} = 20\text{ mA}$	$V_{IN} = 4.5\text{ V}$	25°C	0.3	0.4	0.4	0.5	$\Omega$		
				Full		0.5		0.6			
			$V_{IN} = 3.3\text{ V}$	25°C	0.35	0.6	0.45	0.7			
				Full		0.7		0.8			
			$V_{IN} = 2.5\text{ V}$	25°C	0.4	0.7	0.5	0.8			
				Full		0.8		0.9			
			$V_{IN} = 1.8\text{ V}$	25°C	0.6	0.9	0.7	1			
				Full		1.0		1.1			
$V_{IN} = 1.62\text{ V}$	25°C	0.7	1.0	0.8	1.1						
	Full		1.1		1.2						
$I_{LIM}$	Current limit	$V_{OUT} = 3\text{ V}$	$V_{IN} = 3.3\text{ V}$	Full	100	150	200	100	150	200	mA
$I_{LIM (INRUSH)}$	Power-ON inrush current limit (TPS22949A only)	$V_{OUT} = 3\text{ V}$	$V_{IN} = 3.3\text{ V}$	Full		750			750		
UVLO-CL	Undervoltage shutdown	$V_{IN}$ increasing			1.39	1.49	1.59	1.39	1.49	1.59	V
	Undervoltage shutdown hysteresis				30			30			mV
	OC output logic low voltage	$I_{SINK} = 10\text{ mA}$	$V_{IN} = 4.5\text{ V}$	Full	0.1	0.3	0.1	0.3	0.1	0.3	V
			$V_{IN} = 1.8\text{ V}$		0.2	0.4	0.2	0.4			

### CURRENT LIMITER SWITCHING CHARACTERISTICS

$V_{IN} = 3.3\text{ V}$ ,  $T_A = 25^\circ\text{C}$ ,  $R_L = 500\ \Omega$ ,  $C_L = 0.1\ \mu\text{F}$  (unless otherwise noted)

PARAMETER	TEST CONDITIONS	MIN	TYP	MAX	UNIT	
$t_{ON}$	Turn-ON time		95		$\mu\text{s}$	
$t_{OFF}$	Turn-OFF time		2		$\mu\text{s}$	
$t_r$	$V_{OUT}$ rise time		25		$\mu\text{s}$	
$t_f$	$V_{OUT}$ fall time		10		$\mu\text{s}$	
$t_{BLANK}$	Overcurrent blanking time	6	12	18	ms	
$t_{RSTRT}$	Auto-restart time	40	80	120	ms	
$t_{INRUSH}$	Power-ON inrush current limit time (TPS22949A only)		150		$\mu\text{s}$	
	Short-circuit response time	$V_{IN} = V_{EN1} = 3.3\text{ V}$ , moderate over-current condition			11	$\mu\text{s}$
		$V_{IN} = V_{EN1} = 3.3\text{ V}$ , hard short			5	

## LOW-NOISE LDO REGULATOR ELECTRICAL CHARACTERISTICS

over operating free-air temperature range (unless otherwise noted)

PARAMETER		TEST CONDITIONS	MIN	TYP	MAX	UNIT
$V_{OUTLDO}$	Output voltage <sup>(1)</sup>		1.76	1.8	1.84	V
$\Delta V_{OUTLDO}/\Delta V_{IN}$	$V_{IN}$ line regulation	$V_{IN} = V_{OUTLDO} + 0.5\text{ V to }4.5\text{ V}$ , $I_{OUT} = 1\text{ mA}$		$\pm 0.1$		%/V
	$V_{IN}$ line transient	$\Delta V_{IN} = 400\text{ mV}$ , $t_r = t_f = 1\text{ }\mu\text{s}$		$\pm 2$		mV
$\Delta V_{OUTLDO}/\Delta V_+$	$V_+$ line regulation	$V_{IN} = V_{OUTLDO} + 1.4\text{ V or }2.5\text{ V}$ , whichever is $> 5.5\text{ V}$ , $I_{OUT} = 1\text{ mA}$		$\pm 0.1$		%/V
	$V_+$ line transient	$\Delta V_{IN} = 600\text{ mV}$ , $t_r = t_f = 1\text{ }\mu\text{s}$		$\pm 5$		mV
$\Delta V_{OUTLDO}/\Delta I_{OUT2}$	Load regulation	$I_{OUT2} = 0\text{ to }100\text{ mA}$ (no load to full load)		$\pm 0.01$		%/V
	Load transient	$I_{OUT2} = 0\text{ to }100\text{ mA}$ , $t_r = t_f = 1\text{ }\mu\text{s}$		$\pm 35$		mV
$V_{DO}$	Dropout voltage ( $V_{DO} = V_{IN} - V_{OUTLDO}$ )	$V_{IN} = V_{OUTLDO(NOM)} - 0.1\text{ V}$ , $V_+ - V_{OUTLDO(NOM)} = 1.4\text{ V}$ , $I_{OUT} = 100\text{ mA}$		110	200	mV
$V_{IN}$ PSRR	Power-supply rejection ratio	$V_{OUTCL} - V_{OUTLDO} \geq 0.5\text{ V}$ , $V_+ = V_{OUTLDO} + 1.4\text{ V}$ , $I_{OUT} = 100\text{ mA}$ ,	$f = 10\text{ Hz}$	75		dB
			$f = 100\text{ Hz}$	75		
			$f = 1\text{ kHz}$	80		
			$f = 10\text{ kHz}$	80		
			$f = 100\text{ kHz}$	85		
			$f = 1\text{ MHz}$	85		
$V_+$ PSRR	Power-supply rejection ratio	$V_{OUTCL} - V_{OUTLDO} \geq 0.5\text{ V}$ , $V_+ = V_{OUTLDO} + 1.4\text{ V}$ , $I_{OUT} = 100\text{ mA}$ ,	$f = 10\text{ Hz}$	80		dB
			$f = 100\text{ Hz}$	80		
			$f = 1\text{ kHz}$	75		
			$f = 10\text{ kHz}$	65		
			$f = 100\text{ kHz}$	55		
			$f = 1\text{ MHz}$	35		
$V_N$	Output noise voltage	$V_+ \geq 2.5\text{ V}$ , $V_{OUTLDO} = V_{OUTCL} + 0.5\text{ V}$		50		$\mu\text{Vrms}$
$t_{STR}$	Startup time	$V_{OUT} = 95\%$ , $V_{OUT(NOM)}$ , $I_{OUT} = 100\text{ mA}$ , $C_{OUT} = 2.2\text{ }\mu\text{F}$		130	250	$\mu\text{s}$
UVLO- $V_+$	Undervoltage lockout	$V_+$ rising	2.3	2.45	2.55	V
	Hysteresis	$V_+$ falling		150		mV

(1) LDO output voltage is fixed at 1.8 V. However, output voltages from 0.9 V to 3.6 V in 50 mV increments are available through the use of innovative factory EEPROM programming; minimum order quantities may apply. Contact factory for details and availability.

TYPICAL CHARACTERISTICS

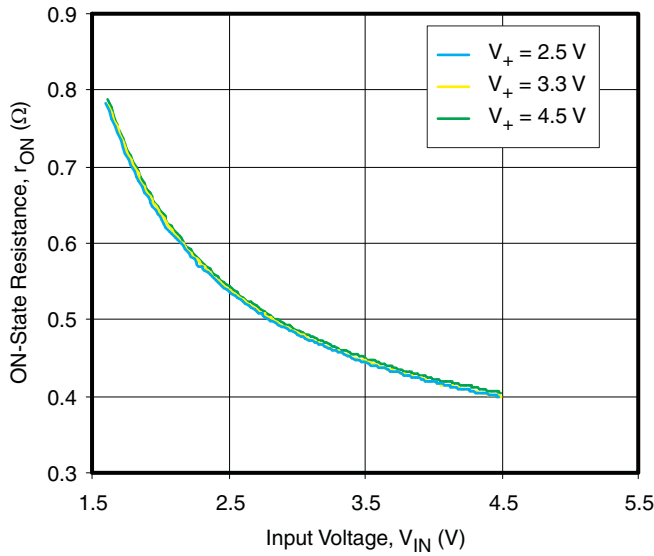

Figure 3. ON-State Resistance vs Input Voltage,  $T_A = 25^\circ\text{C}$

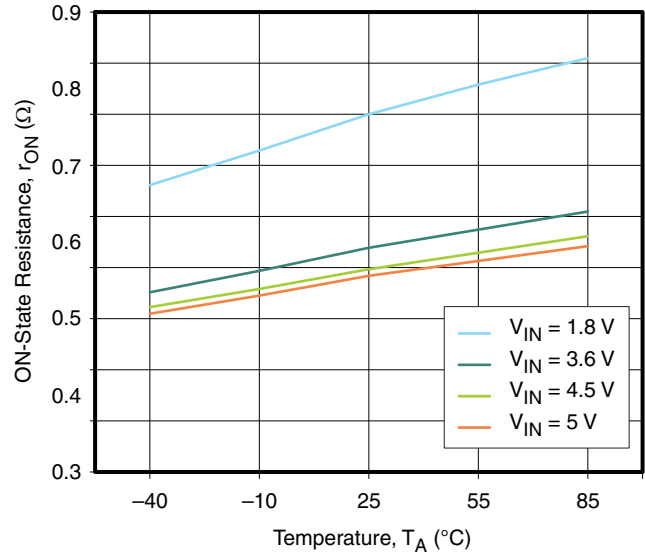

Figure 4. ON-State Resistance vs Temperature,  $V_+ = 5.5\text{ V}$

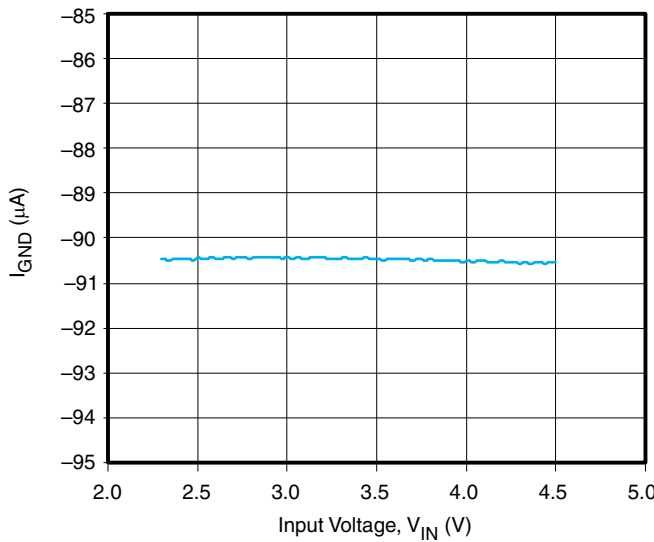

Figure 5. Ground Pin Current vs Input Voltage  $V_+ = 5.5\text{ V}$

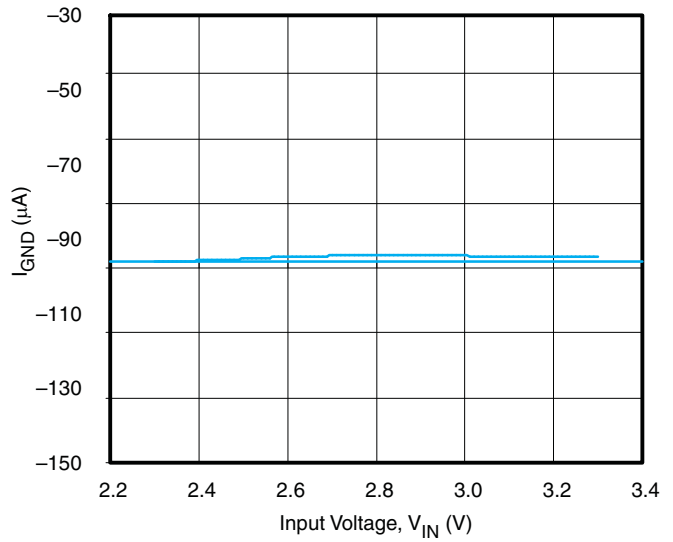

Figure 6. Ground Pin Current vs Input Voltage,  $V_+ = 3.3\text{ V}$



TYPICAL CHARACTERISTICS (continued)

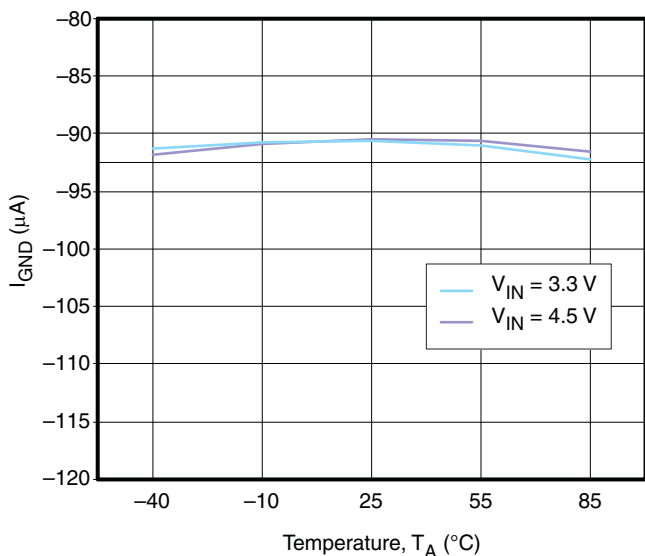

Figure 7. Ground Pin Current vs Temperature,  $V_+ = 5.5\text{ V}$

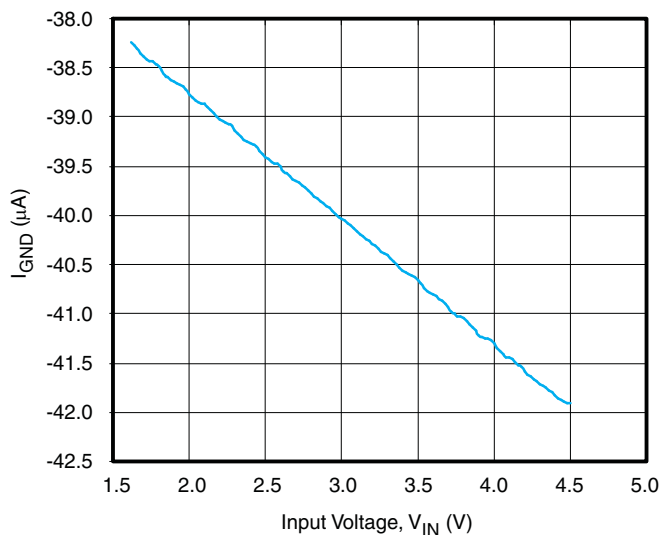

Figure 8. Ground Pin Current vs Input Voltage (Current Limiter Only),  $V_+ = 5.5\text{ V}$

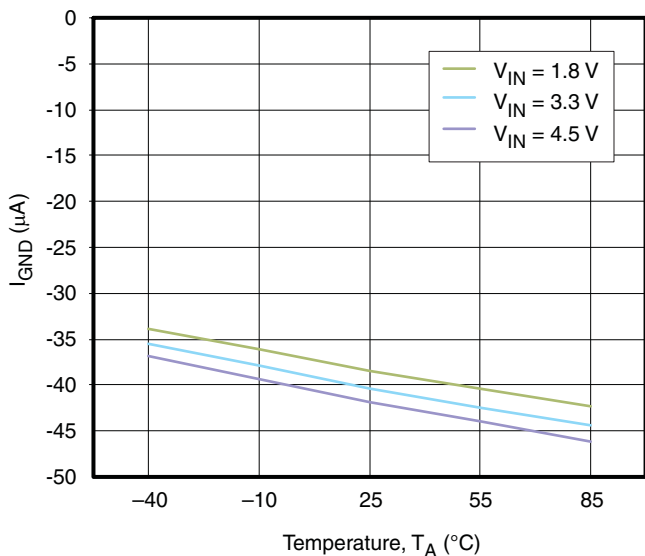

Figure 9. Ground Pin Current vs Temperature (Current Limiter Only),  $V_+ = 5.5\text{ V}$

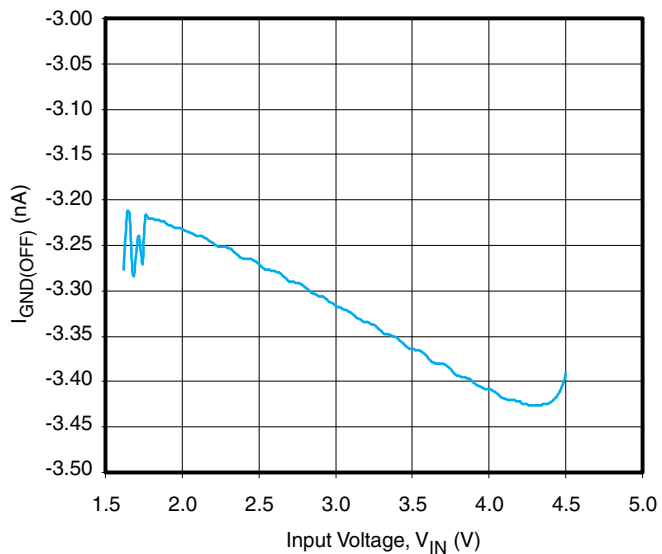

Figure 10. OFF-State Ground Current vs Input Voltage,  $V_+ = 5.5\text{ V}$

TYPICAL CHARACTERISTICS (continued)

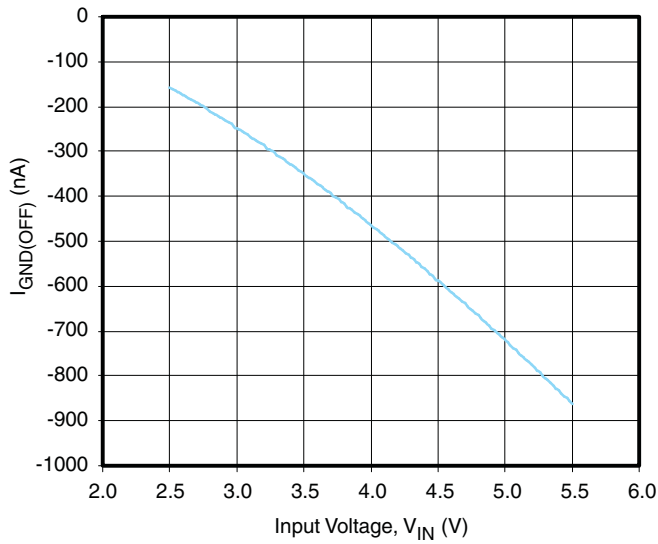

Figure 11. OFF-State Ground Current vs Input Voltage,  $V_{IN} = V_+$

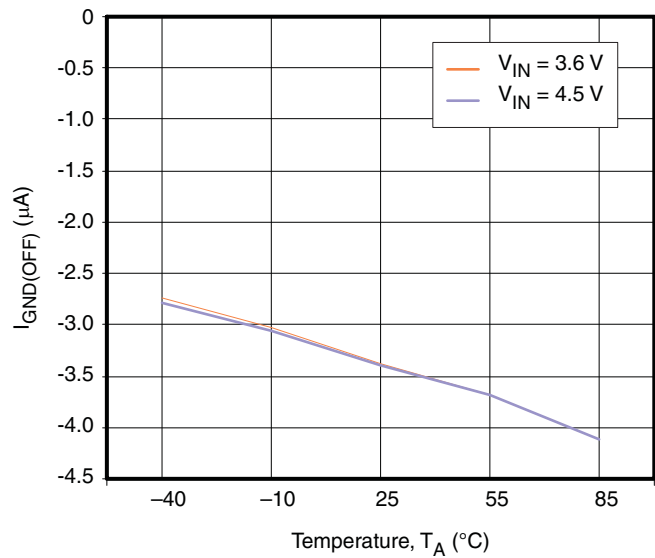

Figure 12. OFF-State Ground Current vs Temperature

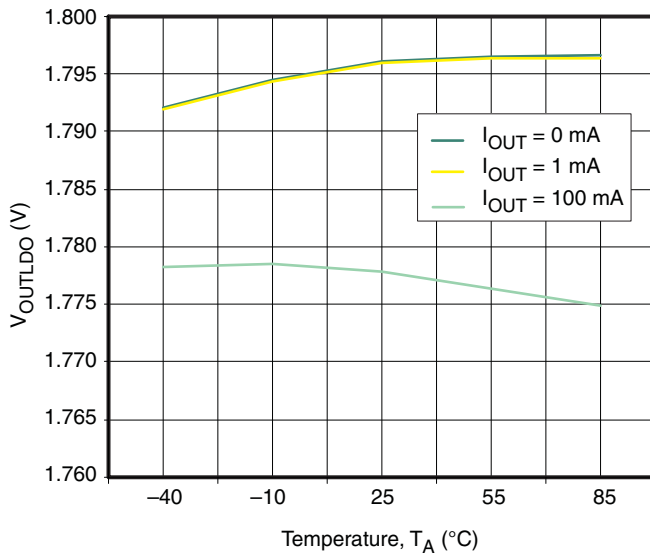

Figure 13. Output Voltage vs Temperature

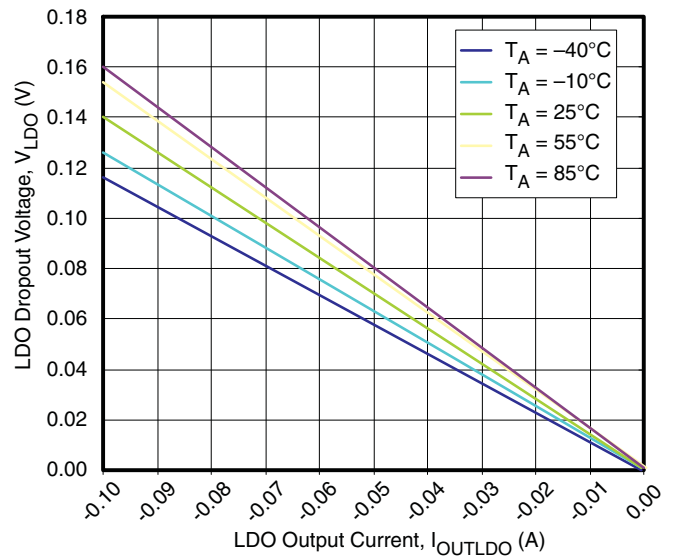

Figure 14. LDO Dropout Voltage vs Output Current

TYPICAL CHARACTERISTICS (continued)

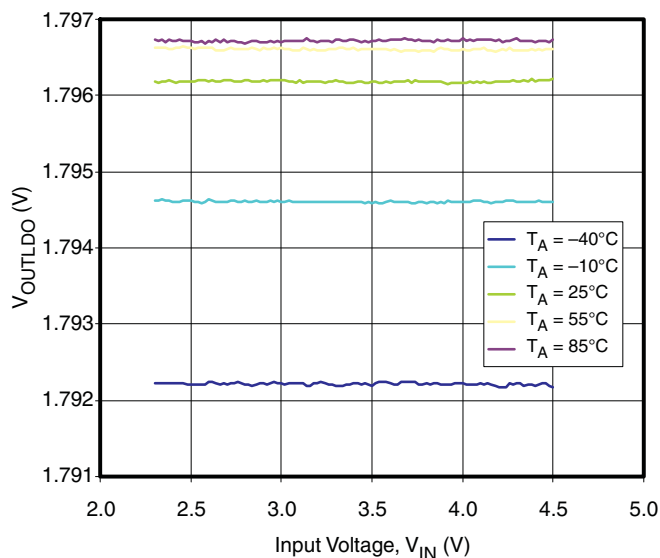

Figure 15. Input Voltage,  $V_{IN}$ , Line Regulation,  $I_{OUT} = 0$  mA

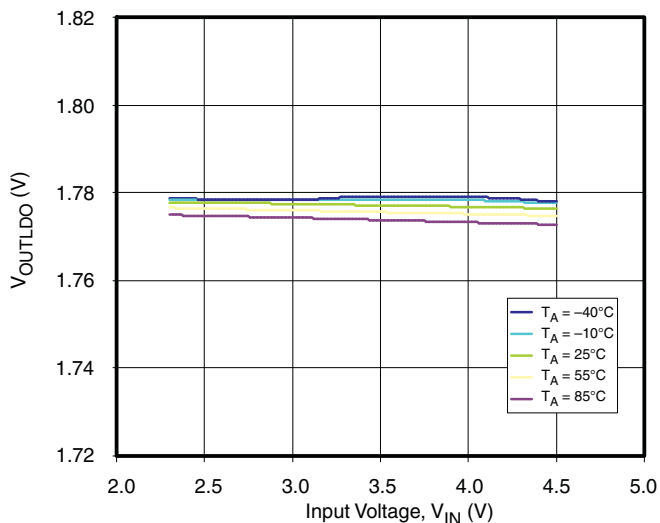

Figure 16. Input Voltage,  $V_{IN}$ , Line Regulation,  $I_{OUT} = 100$  mA

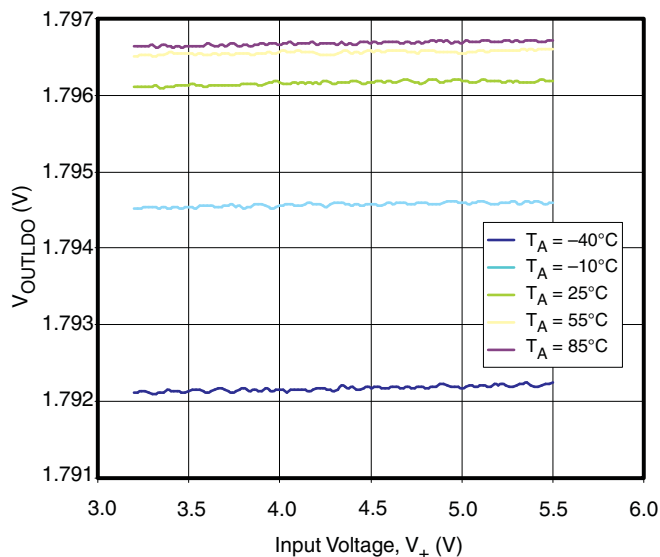

Figure 17. Input Voltage,  $V_+$ , Line Regulation,  $I_{OUT} = 0$  mA

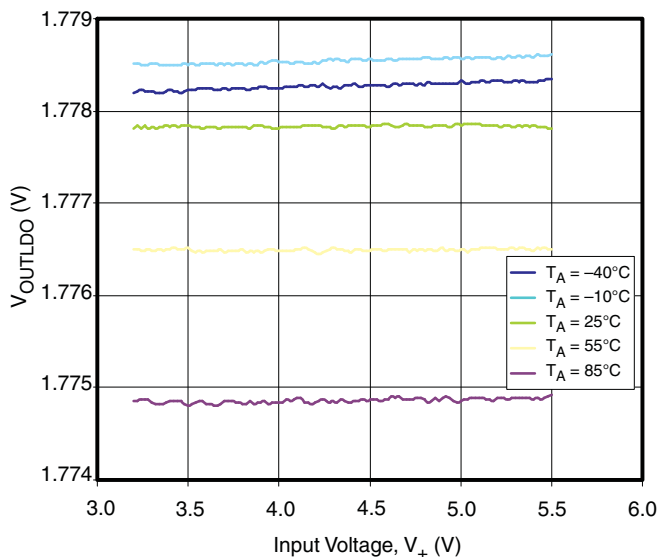

Figure 18. Input Voltage,  $V_+$ , Line Regulation,  $I_{OUT} = 100$  mA

TYPICAL CHARACTERISTICS (continued)

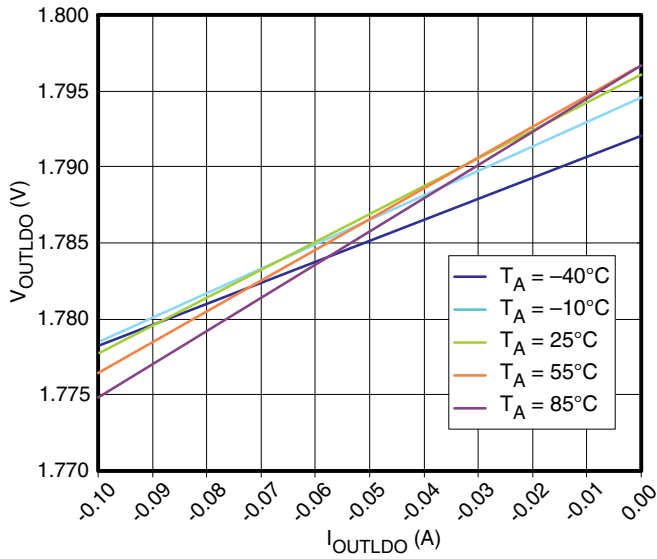

Figure 19. Load Regulation,  $I_{OUT} = 100 \text{ mA}$

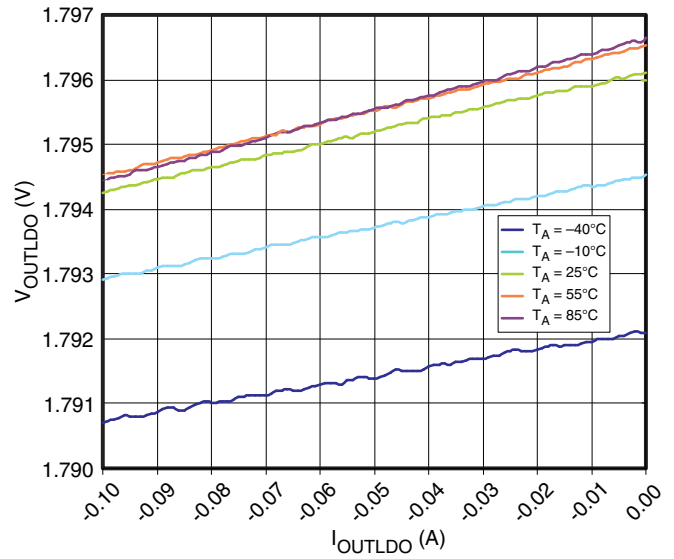

Figure 20. Load Regulation Under Light Loads,  $I_{OUT} = 10 \text{ mA}$

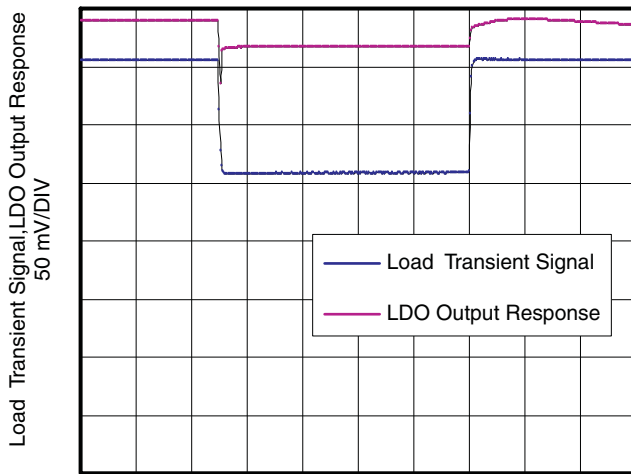

Figure 21. Load Transient

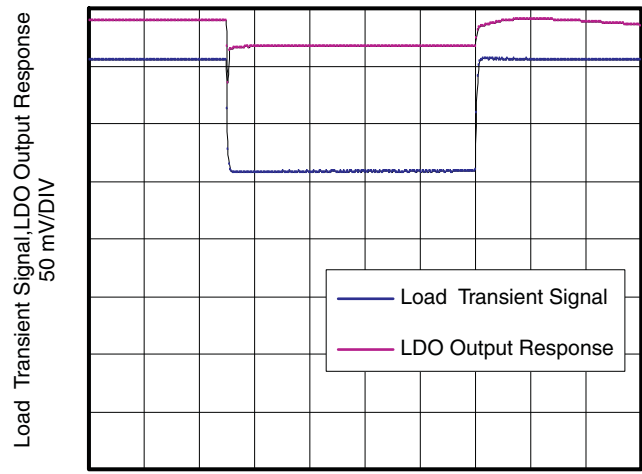

Figure 22.  $V_{IN}$  Load Transient

TYPICAL CHARACTERISTICS (continued)

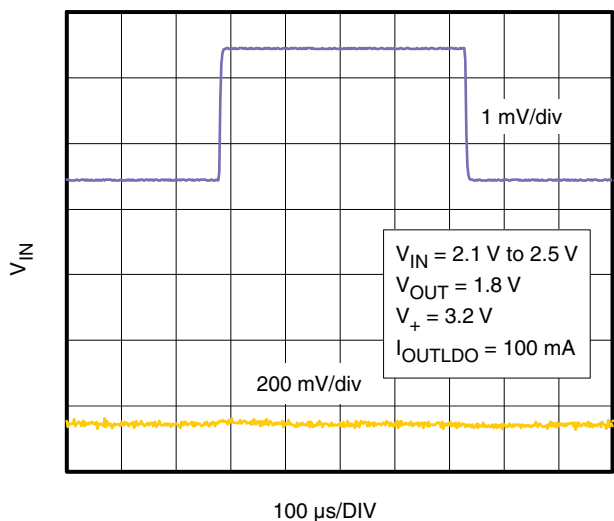

Figure 23.  $V_+$  Load Transient

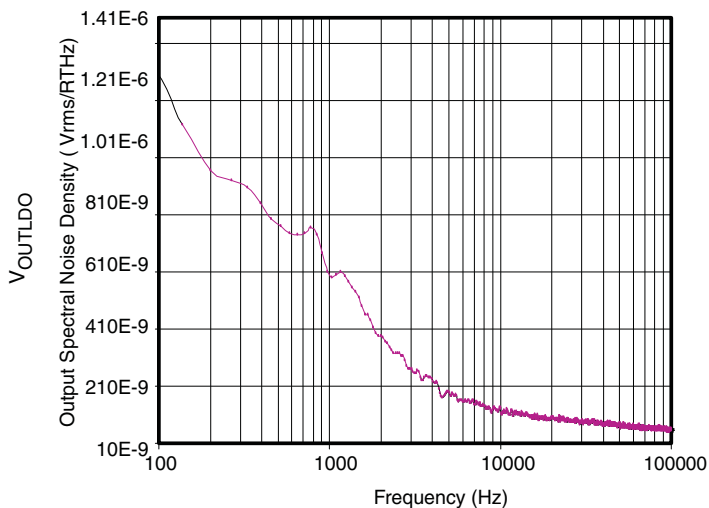

Figure 24. Output Spectral Noise Density vs Frequency

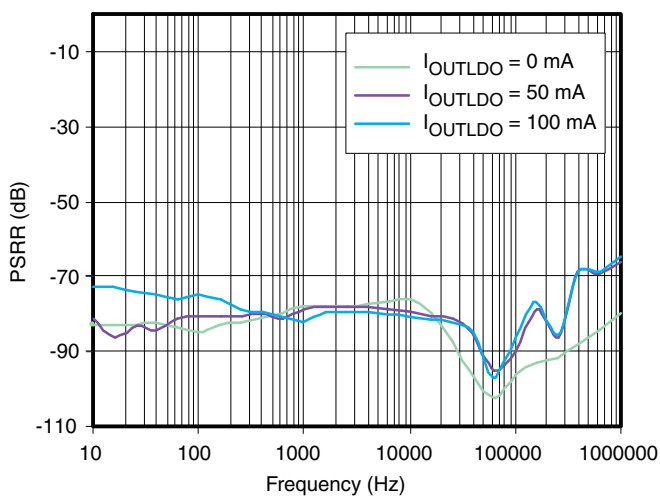

Figure 25. PSRR vs Frequency

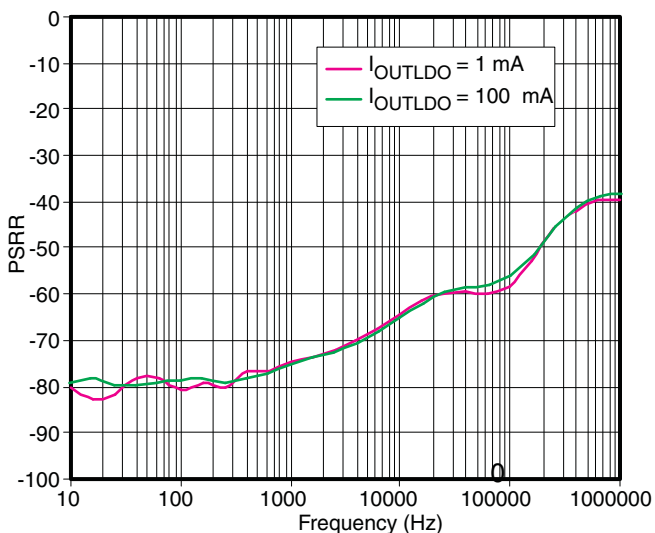

Figure 26.  $V_+$  PSRR vs Frequency

TYPICAL CHARACTERISTICS (continued)

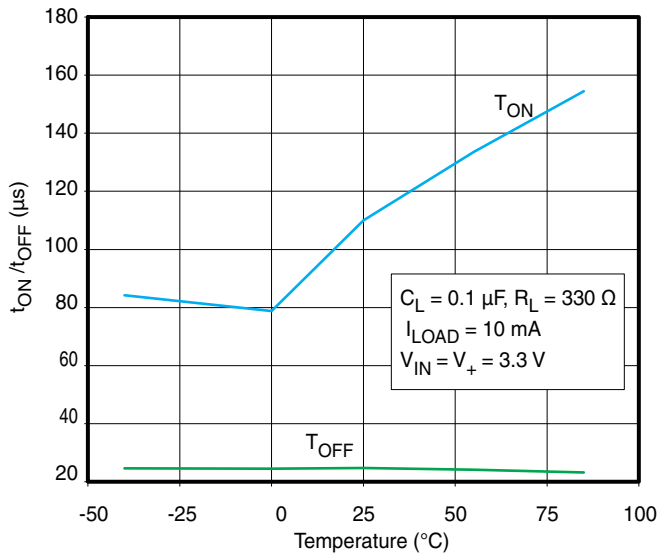

Figure 27. t<sub>ON</sub>/t<sub>OFF</sub> vs Temperature

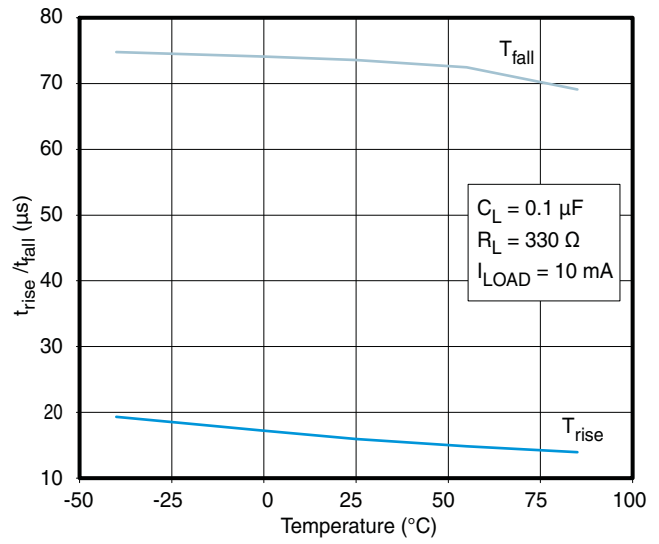

Figure 28. t<sub>rise</sub>/t<sub>fall</sub> vs Temperature

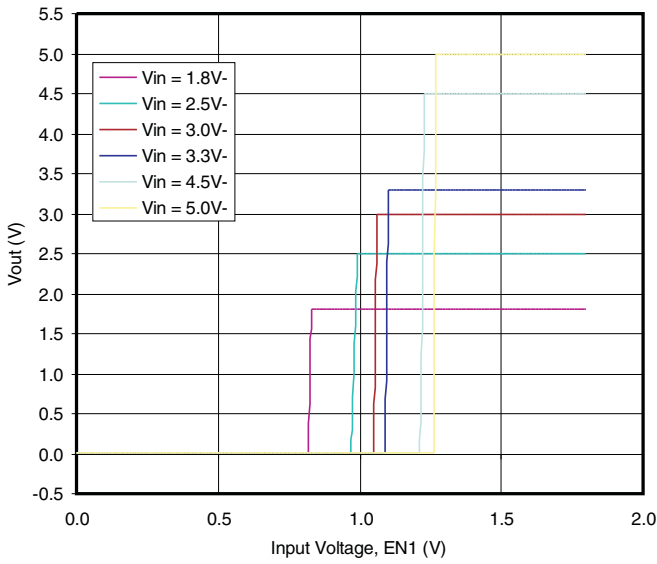

Figure 29. EN1 (Current Limiter) Input Thresholds, V<sub>+</sub> = 5.5 V

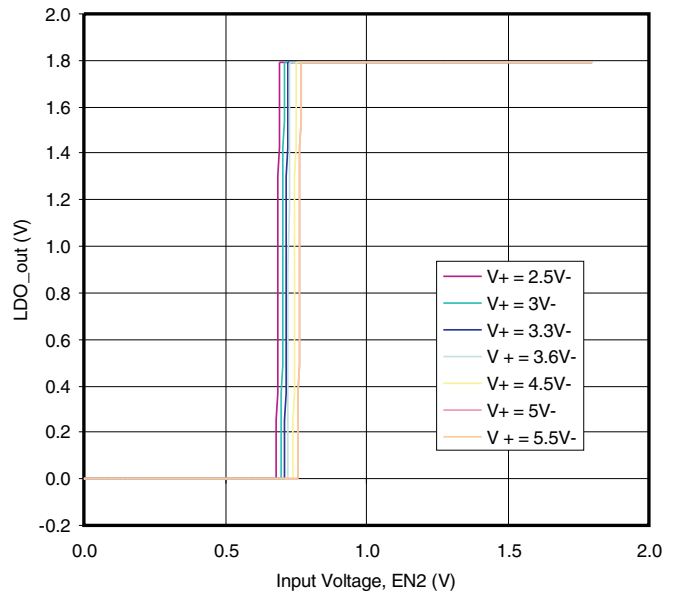

Figure 30. EN2 (LDO) Input Thresholds, V<sub>IN</sub> = 3.3 V

- A. V<sub>DRV</sub> signal forces the device to go into over-current mode
- B. V<sub>DRV</sub> signal forces the device to go into over-current mode

TYPICAL CHARACTERISTICS (continued)

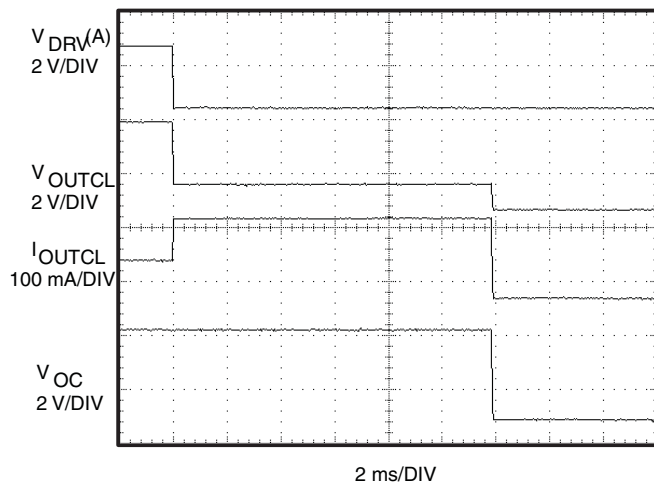

Figure 31.  $t_{BLANK}$  Response

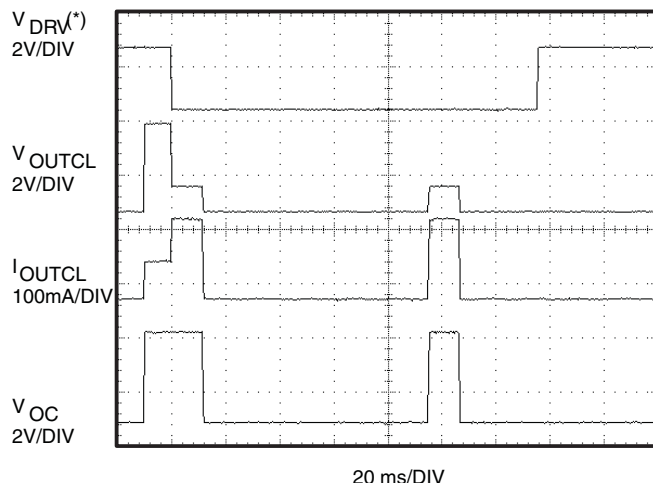

Figure 32.  $t_{RESTART}$  Response

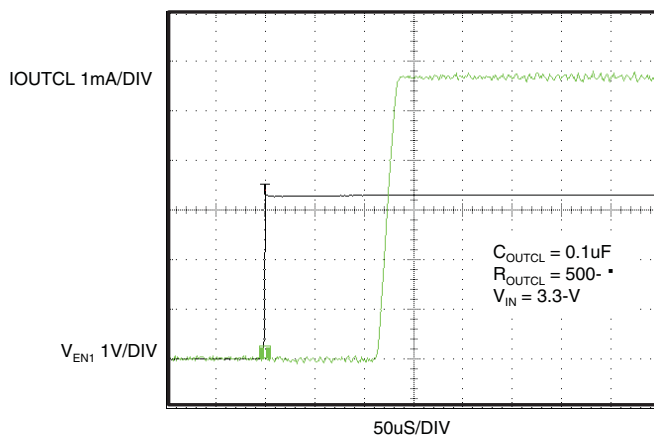

Figure 33. Current Limiter  $t_{ON}$  Response

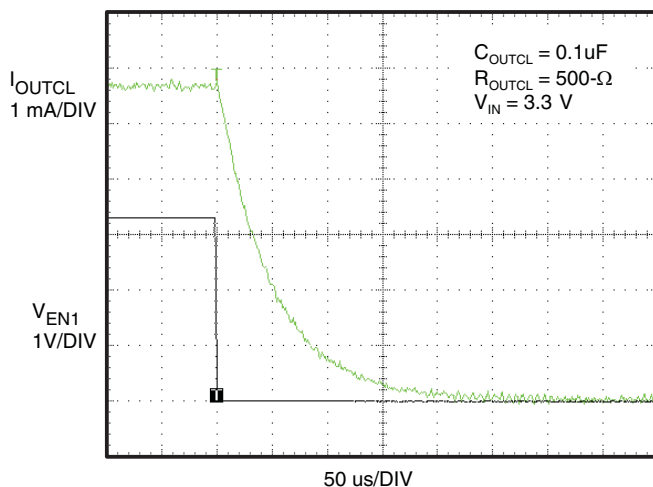

Figure 34. Current Limiter  $t_{OFF}$  Response

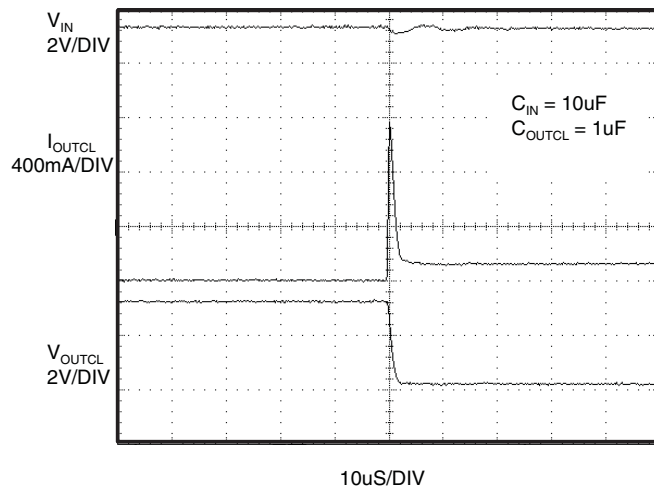

Figure 35. Short-Circuit Response Time ( $V_{OUTCL}$  Shorted to GND)

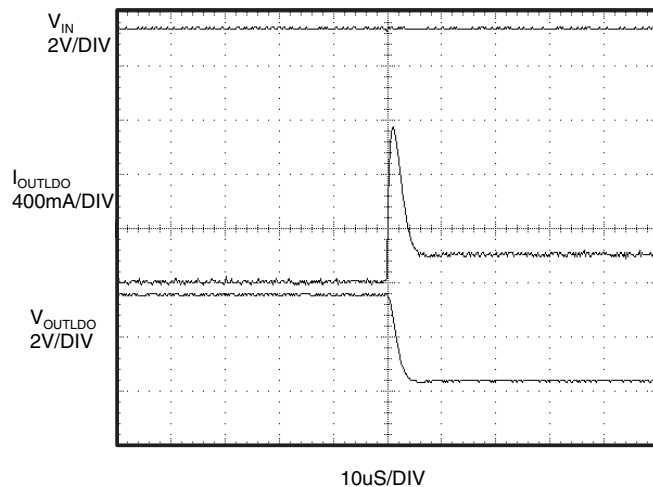

Figure 36. Short-Circuit Response Time ( $V_{OUTLDO}$  Shorted to GND)

TYPICAL CHARACTERISTICS (continued)

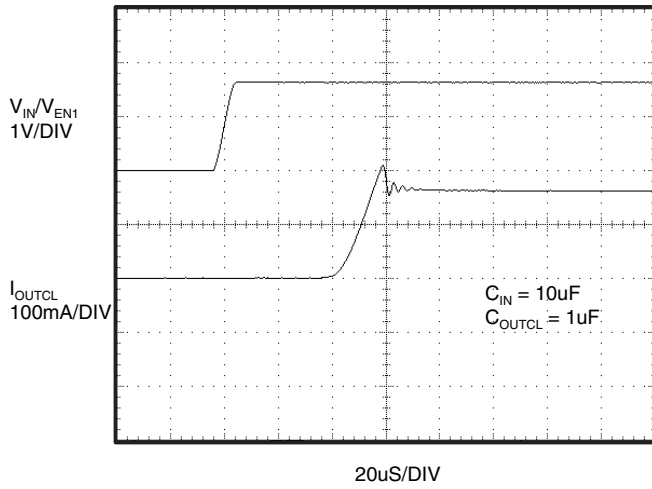

Figure 37. Short-Circuit Response Time (Switch Power-Up to Hard Short) (TPS22949)

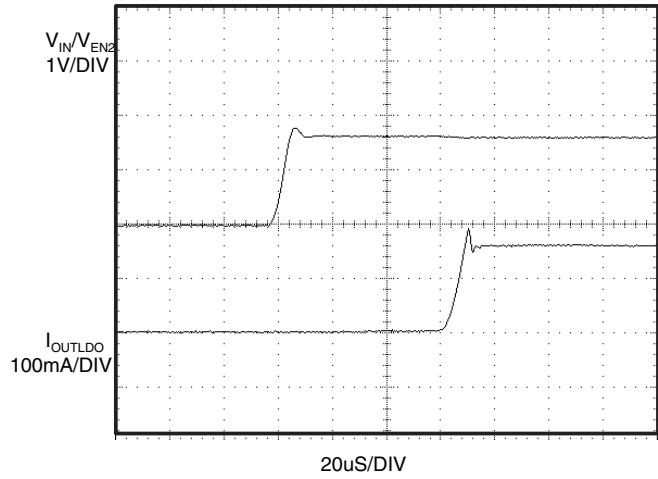

Figure 38. Short-Circuit Response Time (LDO Power-Up to Hard Short) (TPS22949)

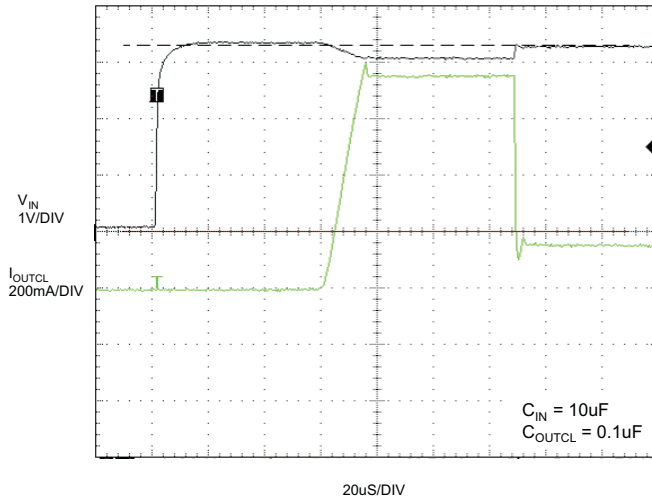

Figure 39. Short-Circuit Response Time (Switch Power-Up to Hard Short) (TPS22949A)

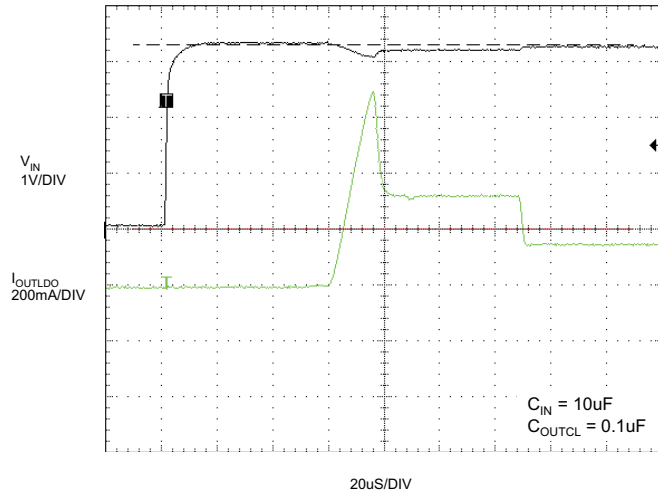

Figure 40. Short-Circuit Response Time (LDO Power-Up to Hard Short) (TPS22949A)



TYPICAL CHARACTERISTICS (continued)

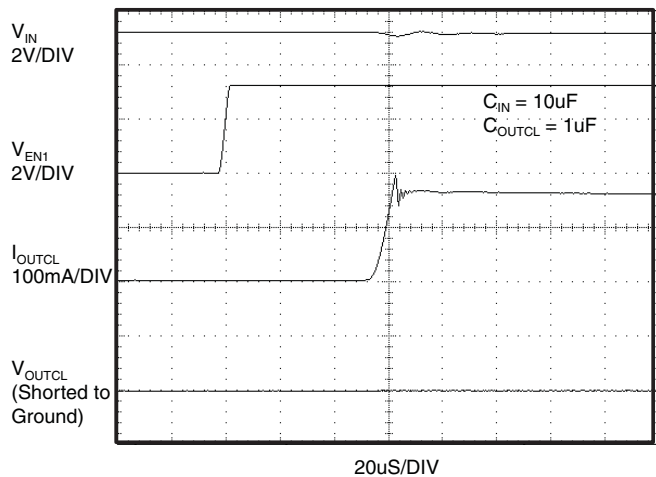

Figure 41. Current Limit Response Time (Current Limiter)

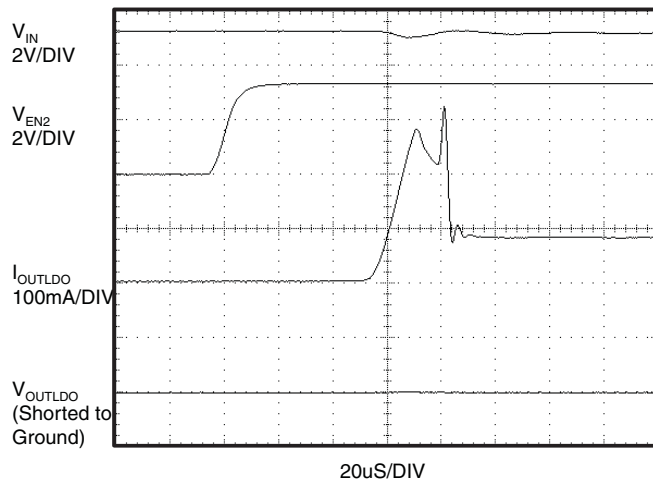

Figure 42. Current Limit Response Time (LDO)

## APPLICATION INFORMATION

### Undervoltage Lockout (UVLO)

The undervoltage lockout turns off the switch if the input voltage drops below the undervoltage lockout threshold. With the ON pin active, the input voltage rising above the undervoltage lockout threshold causes a controlled turn-on of the switch, which limits current over-shoots. The TPS22949/TPS22949A also has a UVLO on the  $V_+$  bias voltage and keep the output of the LDO shut off until the internal circuitry is operating properly.

### Fault Reporting

When an overcurrent, input undervoltage, or overtemperature condition is detected, OC is set active low to signal the fault mode. OC is an open-drain MOSFET and requires a pullup resistor between  $V_{IN}$  and OC. During shutdown, the pulldown on OC is disabled, reducing current draw from the supply.

### Current Limiting

When the switch current reaches the maximum limit, the TPS22949/TPS22949A operates in a constant-current mode to prohibit excessive currents from causing damage. TPS22949/TPS22949A has a minimum current limit of 100 mA.

### Input Voltage

The input voltage ( $V_{IN}$ ) of the current limiter is set from 1.62 V to 4.5 V, however if both the current limiter and the LDO are enabled, the user must be careful to keep the input voltage ( $V_{IN}$ ) greater than 1.8 V + (voltage drop through the switch) + (voltage drop through the LDO); otherwise, the LDO does not have a high enough internal input signal to operate properly.

A current limiter input voltage ramp time less than the blanking time (~10 ms typical) is recommended. If the ramp time extends beyond the blanking period, then the current limiter goes into recycle, and the system may not start or operate properly.

### Input/Output Capacitors

Although an input capacitor is not required for stability of on the input pin ( $V_{IN}$ ), it is good analog design practice to connect a 0.1- $\mu$ F to 1- $\mu$ F low equivalent series resistance (ESR) capacitor across the IN pin input supply near the regulator. This capacitor counteracts reactive input sources and improves transient response, noise rejection, and ripple rejection. A higher value capacitor may be necessary if large, fast rise time load transients are anticipated, or if the device is located close to the power source. If source impedance is not sufficiently low, a 0.1- $\mu$ F input capacitor may be necessary to ensure stability. The  $V_+$  bias pin does not require an input capacitor because it does not source high currents. However, if source impedance is not sufficiently low, a small 0.1- $\mu$ F bypass capacitor is recommended.

A 0.1- $\mu$ F capacitor  $C_{CL}$  should be placed between  $V_{OUTCL}$  and GND. This capacitor prevents parasitic board inductances from forcing  $V_{OUTCL}$  below GND when the switch turns off. For the TPS22949, the total output capacitance must be kept below a maximum value,  $C_{CL(max)}$ , to prevent the part from registering an over-current condition and turning off the switch. The maximum output capacitance can be determined from the following formula:

$$C_{CL} = I_{LIM(MAX)} \times t_{BLANK(MIN)} \div V_{IN}$$

Due to the integral body diode in the PMOS switch, a  $C_{IN}$  greater than  $C_{CL}$  is highly recommended. A  $C_{CL}$  greater than  $C_{IN}$  can cause  $V_{OUTCL}$  to exceed  $V_{IN}$  when the system supply is removed. This could result in current flow through the body diode from  $V_{OUTCL}$  to  $V_{IN}$ .

On TPS22949, a storage capacitor ( $C_{CL}$ ) at the output of the current limiter is recommended to provide enough current to the LDO during the start-up sequence. The storage capacitor is needed to reduce the amount of inrush current supplied through the current-limited load switch to the LDO during the power-up sequence (see [Figure 44](#)). If the  $C_{CL}$  capacitor is too small, the inrush current needed to start the LDO and charge  $C_{LDO}$  could be interpreted by the current limiter as an over-current and, therefore, trigger the current-limiting feature of the switch. The switch would then try to limit the current to the 100-mA limit, and the user would see an undesired drop on the supply line (see [Figure 45](#)).

On TPS22949A, the storage capacitor ( $C_{CL}$ ) is not required. TPS22949A integrates an additional internal circuitry that increases the current limit of the switch to approximately 750 mA (i.e.  $I_{LIM(INRUSH)}$ ) for about 250  $\mu$ s (i.e.  $t_{INRUSH}$ ), initiated when the internal circuitry of the LDO is operating properly (i.e., when the UVLO of the LDO bias ( $V_+$ ) is disabled ( $V_+ > 2.6$  V)). Because the current limit is increased during the power-up sequence, a potential inrush current through the LDO is not interpreted by the current limiter as an over-current. The current needed by the LDO is then be supplied by the input capacitor ( $C_{IN}$ ) of the current limiter (see Figure 45).

The TPS22949 LDO ( $V_{OUTLDO}$ ) is designed to be stable with standard ceramic capacitors with values of 2.2  $\mu$ F or larger at the output. X5R- and X7R-type capacitors are best because they have minimal variation in value and ESR over temperature. Maximum ESR should be less than 250 m $\Omega$ . Figure 43, Figure 44, and Figure 45 illustrate the behavior of the TPS22949 and TPS22949A with a 100-mA sinking load and different capacitor values for a typical application where both enables are tied to the same input voltage (see Figure 43).

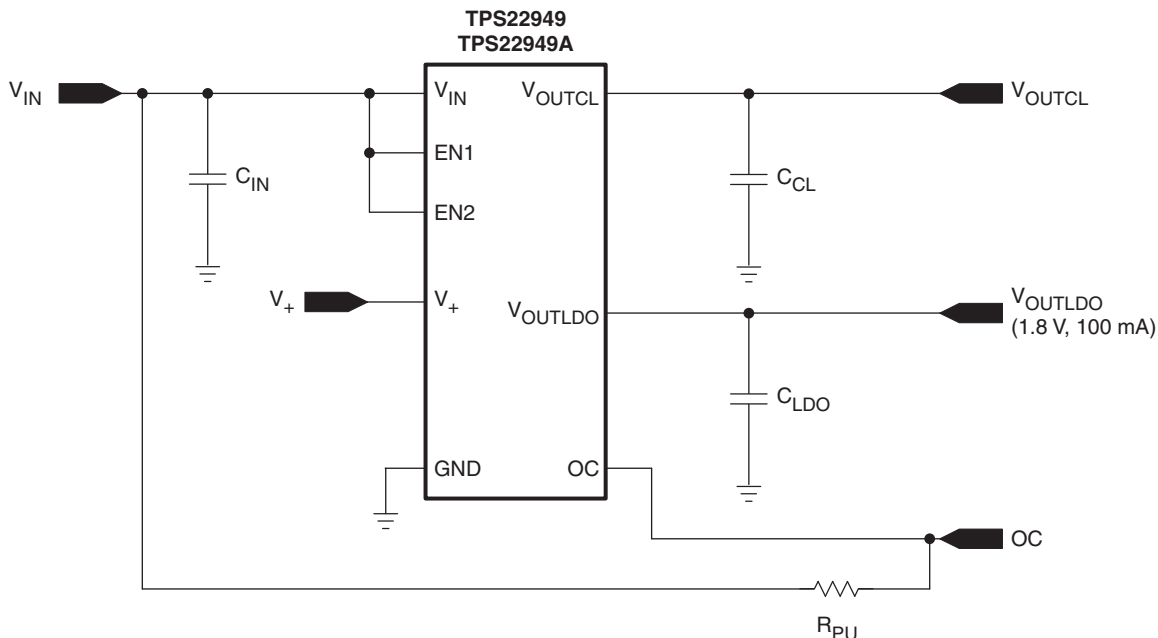

Figure 43. TPS22949/TPS22949A Typical Application With Both Enable Pins Tied to the Input Voltage

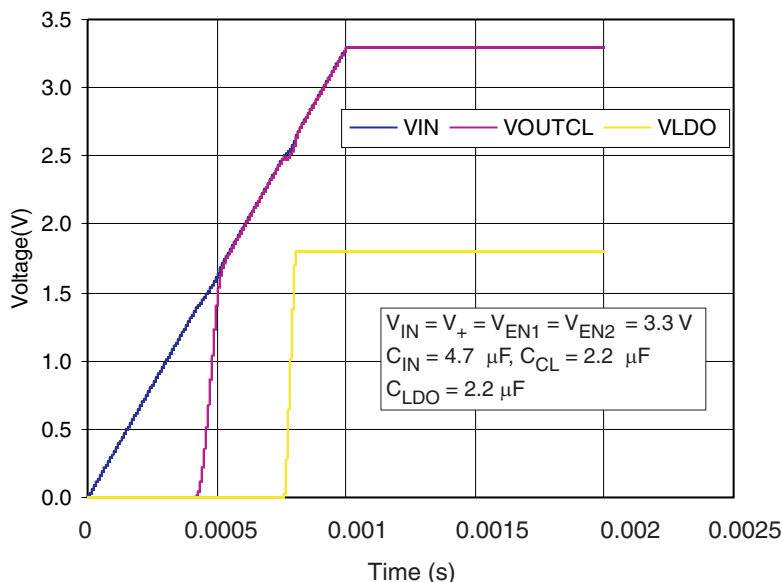

Figure 44. TPS22949 Power-Up Sequence

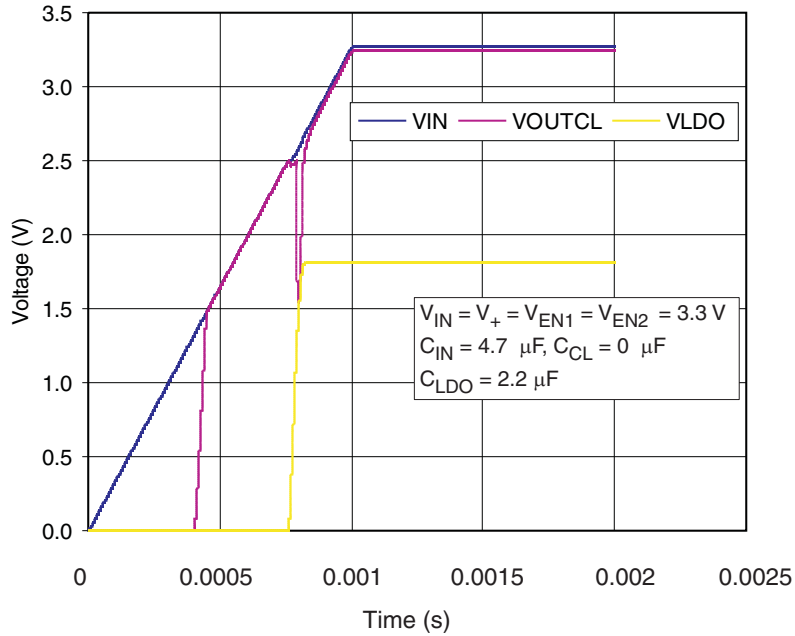

Figure 45. TPS22949 Power-Up Sequence

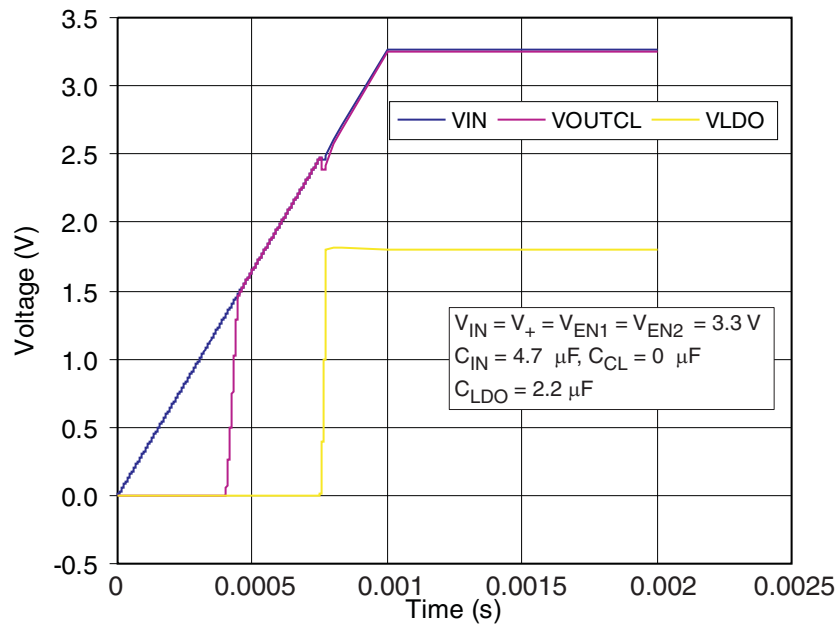

Figure 46. TPS22949A Power-Up Sequence

**PACKAGING INFORMATION**

Orderable Device	Status <sup>(1)</sup>	Package Type	Package Drawing	Pins	Package Qty	Eco Plan <sup>(2)</sup>	Lead/Ball Finish	MSL Peak Temp <sup>(3)</sup>
TPS22949ADRGR	ACTIVE	SON	DRG	8	3000	Green (RoHS & no Sb/Br)	CU NIPDAU	Level-2-260C-1 YEAR
TPS22949AYZPR	ACTIVE	DSBGA	YZP	8	3000	Green (RoHS & no Sb/Br)	SNAGCU	Level-1-260C-UNLIM
TPS22949YZPR	ACTIVE	DSBGA	YZP	8	3000	Green (RoHS & no Sb/Br)	SNAGCU	Level-1-260C-UNLIM

<sup>(1)</sup> The marketing status values are defined as follows:

**ACTIVE:** Product device recommended for new designs.

**LIFEBUY:** TI has announced that the device will be discontinued, and a lifetime-buy period is in effect.

**NRND:** Not recommended for new designs. Device is in production to support existing customers, but TI does not recommend using this part in a new design.

**PREVIEW:** Device has been announced but is not in production. Samples may or may not be available.

**OBsolete:** TI has discontinued the production of the device.

<sup>(2)</sup> Eco Plan - The planned eco-friendly classification: Pb-Free (RoHS), Pb-Free (RoHS Exempt), or Green (RoHS & no Sb/Br) - please check <http://www.ti.com/productcontent> for the latest availability information and additional product content details.

**TBD:** The Pb-Free/Green conversion plan has not been defined.

**Pb-Free (RoHS):** TI's terms "Lead-Free" or "Pb-Free" mean semiconductor products that are compatible with the current RoHS requirements for all 6 substances, including the requirement that lead not exceed 0.1% by weight in homogeneous materials. Where designed to be soldered at high temperatures, TI Pb-Free products are suitable for use in specified lead-free processes.

**Pb-Free (RoHS Exempt):** This component has a RoHS exemption for either 1) lead-based flip-chip solder bumps used between the die and package, or 2) lead-based die adhesive used between the die and leadframe. The component is otherwise considered Pb-Free (RoHS compatible) as defined above.

**Green (RoHS & no Sb/Br):** TI defines "Green" to mean Pb-Free (RoHS compatible), and free of Bromine (Br) and Antimony (Sb) based flame retardants (Br or Sb do not exceed 0.1% by weight in homogeneous material)

<sup>(3)</sup> MSL, Peak Temp. -- The Moisture Sensitivity Level rating according to the JEDEC industry standard classifications, and peak solder temperature.

**Important Information and Disclaimer:** The information provided on this page represents TI's knowledge and belief as of the date that it is provided. TI bases its knowledge and belief on information provided by third parties, and makes no representation or warranty as to the accuracy of such information. Efforts are underway to better integrate information from third parties. TI has taken and continues to take reasonable steps to provide representative and accurate information but may not have conducted destructive testing or chemical analysis on incoming materials and chemicals. TI and TI suppliers consider certain information to be proprietary, and thus CAS numbers and other limited information may not be available for release.

In no event shall TI's liability arising out of such information exceed the total purchase price of the TI part(s) at issue in this document sold by TI to Customer on an annual basis.

DRG (S-PDSO-N8)

PLASTIC SMALL OUTLINE

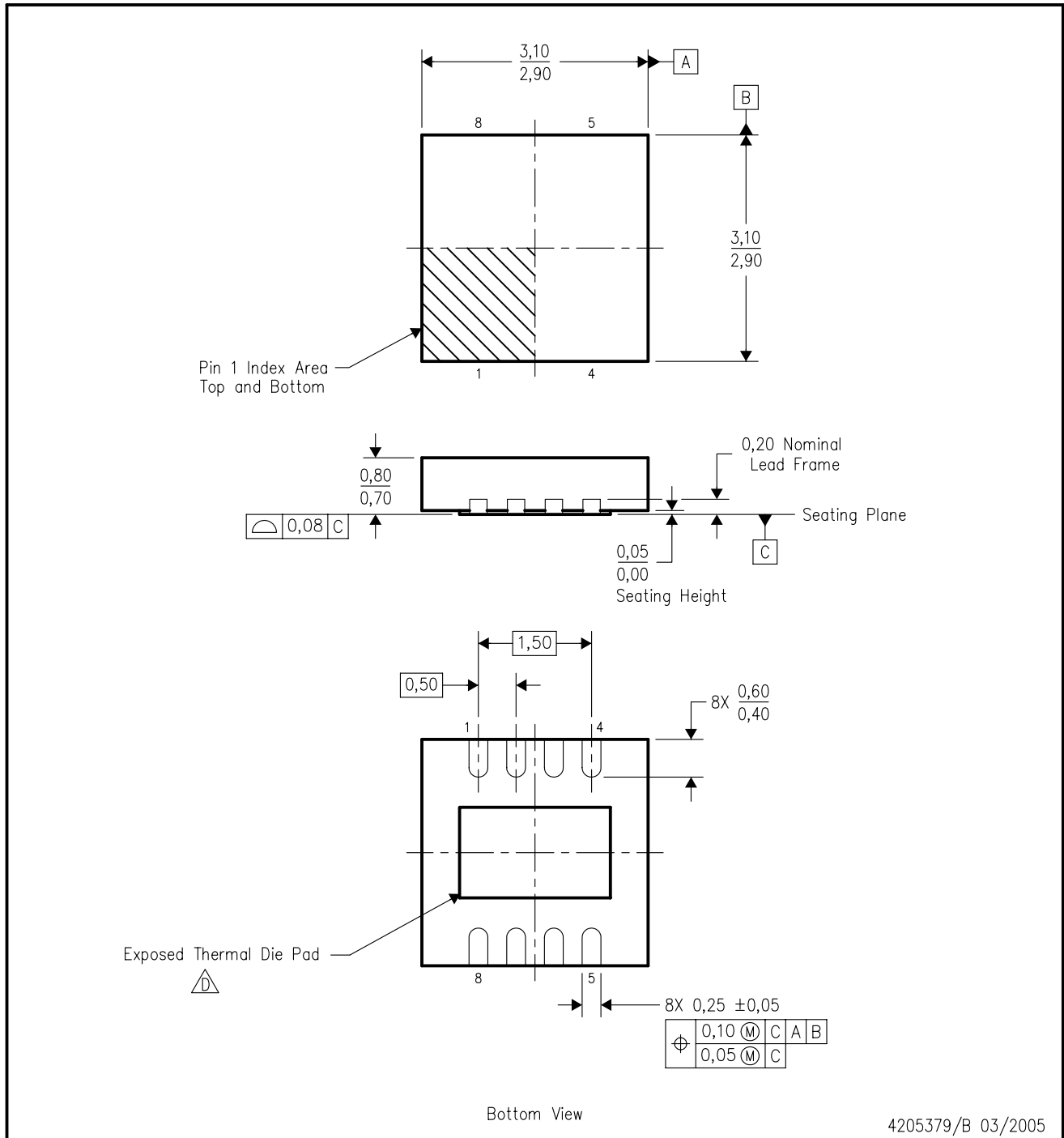

- NOTES:
- A. All linear dimensions are in millimeters. Dimensioning and tolerancing per ASME Y14.5M-1994.
  - B. This drawing is subject to change without notice.
  - C. SON (Small Outline No-Lead) package configuration.
  - △ D. The package thermal pad must be soldered to the board for thermal and mechanical performance. See the Product Data Sheet for details regarding the exposed thermal pad dimensions.
  - E. JEDEC MO-229 package registration pending.

YZP (R-XBGA-N8)

DIE-SIZE BALL GRID ARRAY

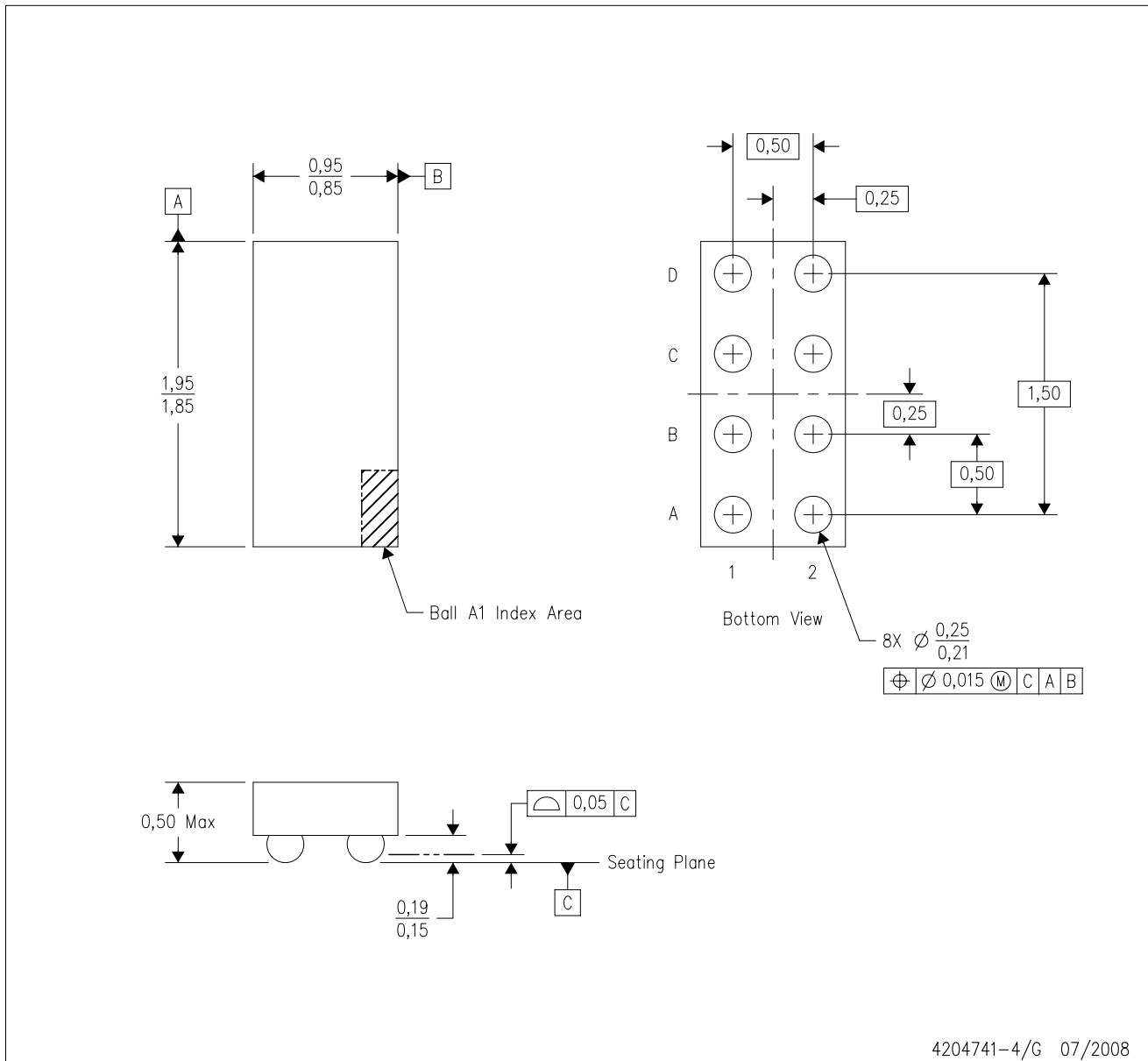

- NOTES:
- A. All linear dimensions are in millimeters. Dimensioning and tolerancing per ASME Y14.5M-1994.
  - B. This drawing is subject to change without notice.
  - C. NanoFree™ package configuration.
  - D. This package is lead-free. Refer to the 8 YEP package (drawing 4204725) for tin-lead (SnPb).

NanoFree is a trademark of Texas Instruments.



[www.BDTC.com/TI](http://www.BDTC.com/TI)

## IMPORTANT NOTICE

Texas Instruments Incorporated and its subsidiaries (TI) reserve the right to make corrections, modifications, enhancements, improvements, and other changes to its products and services at any time and to discontinue any product or service without notice. Customers should obtain the latest relevant information before placing orders and should verify that such information is current and complete. All products are sold subject to TI's terms and conditions of sale supplied at the time of order acknowledgment.

TI warrants performance of its hardware products to the specifications applicable at the time of sale in accordance with TI's standard warranty. Testing and other quality control techniques are used to the extent TI deems necessary to support this warranty. Except where mandated by government requirements, testing of all parameters of each product is not necessarily performed.

TI assumes no liability for applications assistance or customer product design. Customers are responsible for their products and applications using TI components. To minimize the risks associated with customer products and applications, customers should provide adequate design and operating safeguards.

TI does not warrant or represent that any license, either express or implied, is granted under any TI patent right, copyright, mask work right, or other TI intellectual property right relating to any combination, machine, or process in which TI products or services are used. Information published by TI regarding third-party products or services does not constitute a license from TI to use such products or services or a warranty or endorsement thereof. Use of such information may require a license from a third party under the patents or other intellectual property of the third party, or a license from TI under the patents or other intellectual property of TI.

Reproduction of TI information in TI data books or data sheets is permissible only if reproduction is without alteration and is accompanied by all associated warranties, conditions, limitations, and notices. Reproduction of this information with alteration is an unfair and deceptive business practice. TI is not responsible or liable for such altered documentation. Information of third parties may be subject to additional restrictions.

Resale of TI products or services with statements different from or beyond the parameters stated by TI for that product or service voids all express and any implied warranties for the associated TI product or service and is an unfair and deceptive business practice. TI is not responsible or liable for any such statements.

TI products are not authorized for use in safety-critical applications (such as life support) where a failure of the TI product would reasonably be expected to cause severe personal injury or death, unless officers of the parties have executed an agreement specifically governing such use. Buyers represent that they have all necessary expertise in the safety and regulatory ramifications of their applications, and acknowledge and agree that they are solely responsible for all legal, regulatory and safety-related requirements concerning their products and any use of TI products in such safety-critical applications, notwithstanding any applications-related information or support that may be provided by TI. Further, Buyers must fully indemnify TI and its representatives against any damages arising out of the use of TI products in such safety-critical applications.

TI products are neither designed nor intended for use in military/aerospace applications or environments unless the TI products are specifically designated by TI as military-grade or "enhanced plastic." Only products designated by TI as military-grade meet military specifications. Buyers acknowledge and agree that any such use of TI products which TI has not designated as military-grade is solely at the Buyer's risk, and that they are solely responsible for compliance with all legal and regulatory requirements in connection with such use.

TI products are neither designed nor intended for use in automotive applications or environments unless the specific TI products are designated by TI as compliant with ISO/TS 16949 requirements. Buyers acknowledge and agree that, if they use any non-designated products in automotive applications, TI will not be responsible for any failure to meet such requirements.

Following are URLs where you can obtain information on other Texas Instruments products and application solutions:

<b>Products</b>		<b>Applications</b>	
Amplifiers	<a href="http://amplifier.ti.com">amplifier.ti.com</a>	Audio	<a href="http://www.ti.com/audio">www.ti.com/audio</a>
Data Converters	<a href="http://dataconverter.ti.com">dataconverter.ti.com</a>	Automotive	<a href="http://www.ti.com/automotive">www.ti.com/automotive</a>
DLP® Products	<a href="http://www.dlp.com">www.dlp.com</a>	Communications and Telecom	<a href="http://www.ti.com/communications">www.ti.com/communications</a>
DSP	<a href="http://dsp.ti.com">dsp.ti.com</a>	Computers and Peripherals	<a href="http://www.ti.com/computers">www.ti.com/computers</a>
Clocks and Timers	<a href="http://www.ti.com/clocks">www.ti.com/clocks</a>	Consumer Electronics	<a href="http://www.ti.com/consumer-apps">www.ti.com/consumer-apps</a>
Interface	<a href="http://interface.ti.com">interface.ti.com</a>	Energy	<a href="http://www.ti.com/energy">www.ti.com/energy</a>
Logic	<a href="http://logic.ti.com">logic.ti.com</a>	Industrial	<a href="http://www.ti.com/industrial">www.ti.com/industrial</a>
Power Mgmt	<a href="http://power.ti.com">power.ti.com</a>	Medical	<a href="http://www.ti.com/medical">www.ti.com/medical</a>
Microcontrollers	<a href="http://microcontroller.ti.com">microcontroller.ti.com</a>	Security	<a href="http://www.ti.com/security">www.ti.com/security</a>
RFID	<a href="http://www.ti-rfid.com">www.ti-rfid.com</a>	Space, Avionics & Defense	<a href="http://www.ti.com/space-avionics-defense">www.ti.com/space-avionics-defense</a>
RF/IF and ZigBee® Solutions	<a href="http://www.ti.com/lprf">www.ti.com/lprf</a>	Video and Imaging	<a href="http://www.ti.com/video">www.ti.com/video</a>
		Wireless	<a href="http://www.ti.com/wireless-apps">www.ti.com/wireless-apps</a>

Mailing Address: Texas Instruments, Post Office Box 655303, Dallas, Texas 75265  
Copyright © 2010, Texas Instruments Incorporated

[www.BDTIC.com/TI](http://www.BDTIC.com/TI)