

## 10-A STEP-DOWN SYNCHRONOUS SWITCHER WITH INTEGRATED MOSFETs

### FEATURES

- Input Voltage Range: 3 V to 14 V
- Output Voltage Range: 0.75 V to 5.5 V
- Integrated Power MOSFETs with 10-A Continuous Current Output
- < 5- $\mu$ A Shutdown Current
- D-CAP™ Mode with Fast Transient Response
- Programmable Switching Frequency with External Resistor From 100 kHz to 1 MHz
- Selectable Auto-Skip or PWM-Only Operation
- < 1% Initial Reference Accuracy
- Internal Soft-Start Control
- Integrated Boost Diode
- Power Good Signal
- Adjustable Overcurrent Limit via External Resistor
- OVP/UVP/UVLO Protection
- Integrated Selectable Output Discharge
- Prebias Output Voltage Start-Up with Disabled Output Discharge
- Thermal Shutdown
- 40-Pin QFN Package with PowerPAD™
- Supports All Ceramic Output Capacitors

### APPLICATIONS

- Portable Device Application
- Notebook Computers
- Server and Desktop

### DESCRIPTION

The TPS51315 is a D-CAP™ Mode, 10-A, synchronous step-down converter with integrated MOSFETs. The combination of D-CAP™ mode and on-board MOSFETs provides fast transient response performance with ease of use, less external component count and small footprint. Externally adjustable switching frequency allows optimal design between component size and efficiency tradeoff. Ceramic output capacitors can be employed by adding a few extra components. The TPS51315 is available in the thermally-efficient 40-pin, 5 mm x 7 mm, QFN package and is specified from -40°C to 85°C ambient.

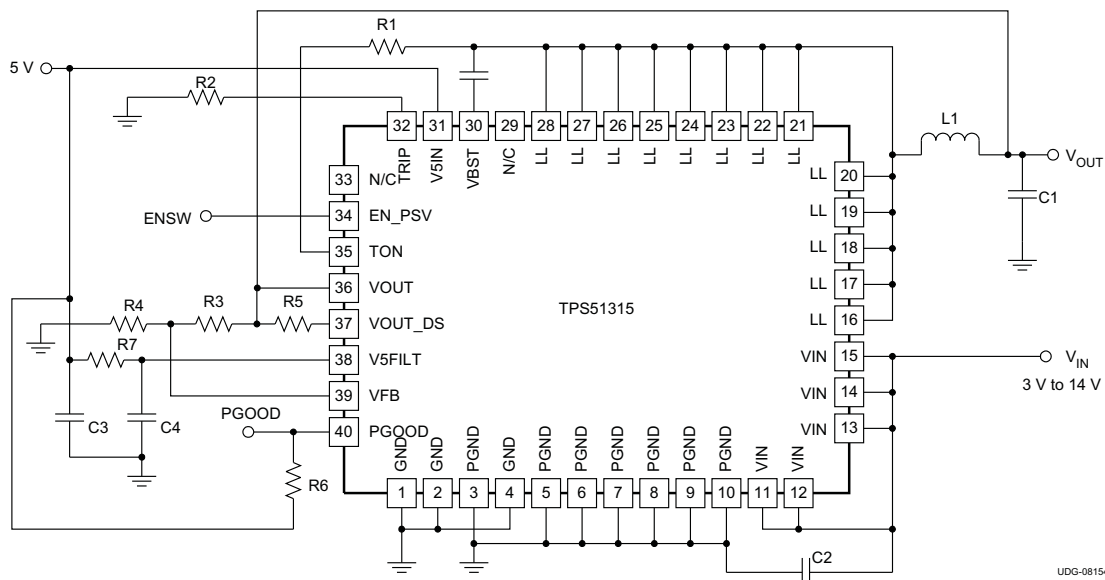

UDG-08154



Please be aware that an important notice concerning availability, standard warranty, and use in critical applications of Texas Instruments semiconductor products and disclaimers thereto appears at the end of this data sheet.

D-CAP, PowerPAD are trademarks of Texas Instruments.

PRODUCTION DATA information is current as of publication date. Products conform to specifications per the terms of the Texas Instruments standard warranty. Production products are not necessarily include testing of all parameters.

Copyright © 2009 Texas Instruments Incorporated



These devices have limited built-in ESD protection. The leads should be shorted together or the device placed in conductive foam during storage or handling to prevent electrostatic damage to the MOS gates.

### ORDERING INFORMATION<sup>(1)</sup>

T <sub>J</sub>	PACKAGE	ORDERABLE PART NUMBER	PINS	OUTPUT SUPPLY	MINIMUM ORDER QUANTITY	ECO PLAN <sup>(2)</sup>
-40°C to 125°C	Plastic QFN (RGF)	TPS51315RGFT	40	Tape and Reel	250	Green (RoHS and no Pb/Br)
		TPS51315RGFR			3000	

(1) For most current package and ordering information, see the *Package Option Addendum* at the end of this document, or see the web site at [www.ti.com](http://www.ti.com).

(2) These devices meet the following planned eco-friendly classification:

**Green (RoHS and No Sb/Br):** Texas Instruments defines *Green* to mean Pb-free (RoHS compatible) and free of bromine (Br)- and antimony (Sb)-based flame retardants. Refer to the [Quality and Lead-Free \(Pb-Free\) Data](#) web site for more information. These devices have a Cu NiPdAu lead/ball finish.

### ABSOLUTE MAXIMUM RATINGS<sup>(1)</sup>

		TPS51315	UNIT
Input voltage range	VIN	-0.3 to 20	V
	VBST	-0.3 to 26	
	VBST (with respect to LL)	-0.3 to 6	
	EN_PSV, TRIP, V5IN, V5FILT	-0.3 to 6	
	VOUT, VOUT_DS	-0.3 to 6	
	TON	-0.3 to 6	
Output voltage range	LL	-1 to 20	V
	PGOOD	-0.3 to 6	
	PGND	-0.3 to 0.3	
Source/Sink current	TON	1	mA
	VBST	50	
Operating free-air temperature, T <sub>A</sub>		-40 to 85	°C
Storage temperature range, T <sub>stg</sub>		-55 to 150	
Junction temperature range, T <sub>J</sub>		-40 to 125	
Lead temperature 1,6 mm (1/16 inch) from case for 10 seconds		300	

(1) Stresses beyond those listed under *Absolute Maximum Ratings* may cause permanent damage to the device. These are stress ratings only, and functional operation of the device at these or any other conditions beyond those indicated under *Recommended Operating Conditions* is not implied. Exposure to absolute-maximum-rated conditions for extended periods may affect device reliability.

### RECOMMENDED OPERATING CONDITIONS

		MIN	NOM	MAX	UNIT
Input voltage range	VIN	3		14	V
	VBST (with respect to LL)	4.5		5.5	
	EN_PSV, V5IN, V5FILT, VOUT, VOUT_DS	-0.1		5.5	
Output voltage range	LL	-0.8		15	V
	PGOOD	-0.1		5.5	
Junction temperature range, T <sub>J</sub>		-40		125	°C

### PACKAGE DISSIPATION RATINGS

PACKAGE	T <sub>A</sub> = 25°C POWER RATING	DERATING FACTOR ABOVE T <sub>A</sub> = 25°C	T <sub>A</sub> = 85°C POWER RATING
40-Pin Plastic QFN (RGF)	2.85 W	25 mW/°C	1.35 W

**ELECTROSTATIC DISCHARGE (ESD) PROTECTION**

	<b>MIN</b>	<b>TYP</b>	<b>MAX</b>	<b>UNIT</b>
Human Body Model (HBM)		1500		V
Charged Device Model (CDM)		500		

## ELECTRICAL CHARACTERISTICS

over recommended free-air temperature range (unless otherwise noted)

PARAMETER		CONDITIONS	MIN	TYP	MAX	UNIT
<b>SUPPLY CURRENT</b>						
$I_{V5IN}$	V5IN supply current	V5IN current, $T_A = 25^\circ\text{C}$ , No Load, $V_{EN\_PSV} = 5\text{V}$ , $V_{VFB} = 0.75\text{V}$ , $V_{LL} = 0.5\text{V}$		0	1	$\mu\text{A}$
$I_{V5FILT}$	V5FILT supply current	V5FILT current, $T_A = 25^\circ\text{C}$ , No Load, $V_{EN\_PSV} = 5\text{V}$ , $V_{VFB} = 0.75\text{V}$ , $V_{LL} = 0.5\text{V}$		400		$\mu\text{A}$
$I_{V5INSDN}$	V5IN shutdown current	V5IN current, $T_A = 25^\circ\text{C}$ , No Load, $V_{EN\_PSV} = 0\text{V}$		0	1	$\mu\text{A}$
$I_{V5FILTS DN}$	V5FILT shutdown current	V5FILT current, $T_A = 25^\circ\text{C}$ , No Load, $V_{EN\_PSV} = 0\text{V}$	1.5	4.5	7.5	$\mu\text{A}$
<b>VOUT AND VREF VOLTAGES</b>						
$V_{OUT}$	Output voltage	Adjustable output range	0.75		5.5	V
$V_{VFB}$	VFB regulation voltage	$V_{VFB}$ voltage		751		mV
$V_{VFB\_TOL}$	VFB regulation voltage tolerance	$T_A = 25^\circ\text{C}$ , bandgap initial accuracy	-0.9%		0.9%	
		$0^\circ\text{C} \leq T_A \leq 85^\circ\text{C}$	-1.3%		1.3%	
		$-40^\circ\text{C} \leq T_A \leq 85^\circ\text{C}$	-1.6%		1.6%	
$I_{VFB}$	VFB input current	$V_{VFB} = 0.75\text{V}$ , $T_A = 25^\circ\text{C}$		-0.025		$\mu\text{A}$
$R_{Dischg}$	VOUT_DS discharge resistance	$V_{EN\_PSV} = 0\text{V}$ , $V_{OUT\_DS} = 0.75\text{V}$		20		$\Omega$
<b>HOUSEKEEPING CLOCK, ON-TIME TIMER, and INTERNAL SOFT START</b>						
$T_{ONN}$	Nominal on-time	$V_{IN} = 10\text{V}$ , $V_{OUT} = 2.5\text{V}$ , $R_{T(on)} = 250\text{k}\Omega$		1115		ns
$T_{ONF}$	Fast switch on-time	$V_{IN} = 10\text{V}$ , $V_{OUT} = 2.5\text{V}$ , $R_{T(on)} = 100\text{k}\Omega$		865		ns
$T_{ONS}$	Slow switch on-time	$V_{IN} = 10\text{V}$ , $V_{OUT} = 2.5\text{V}$ , $R_{T(on)} = 400\text{k}\Omega$		1515		ns
$T_{ON}$	Minimum on-time	$V_{IN} = 10\text{V}$ , $V_{OUT} = 0.75\text{V}$ , $R_{T(on)} = 100\text{k}\Omega^{(1)}$		170	200	ns
$T_{OFF(min)}$	Minimum off-time	$T_A = 25^\circ\text{C}$ , $V_{VFB} = 0.75\text{V}$ , $V_{LL} = -0.1\text{V}$ , $V_{TRIP} = \text{OPEN}$		385		ns
$T_{SS}$	Internal soft-start time	$T_A = 25^\circ\text{C}$ , $V_{EN\_PSV} > 3\text{V}$		1.06		ms
$f_{CLK}$	Clock frequency	Soft-start, UVP, OVP, PGOOD <sup>(2)</sup>	240	250	260	kHz
<b>INTERNAL BST DIODE</b>						
$V_{FBST}$	Forward voltage	$V_{V5IN-VBST}$ , $I_F = 10\text{mA}$ , $T_A = 25^\circ\text{C}$	0.7	0.8	0.9	V
$I_{VBSTLK}$	VBST leakage current	$V_{VBST} = 26\text{V}$ , $V_{LL} = 20\text{V}$ , $T_A = 25^\circ\text{C}$		0.1	1	$\mu\text{A}$
<b>PROTECTIONS: OVERCURRENT LIMIT (OCL), UNDERCURRENT LIMIT (UCL)</b>						
$V_{OCL(off)}$	Overcurrent limit comparator offset	$(V_{TRIP-GND} - V_{PGND-LL})$ voltage $V_{TRIP-GND} = 60\text{mV}$	-10	0	10	mV
$V_{UCL(off)}$	Undercurrent limit comparator offset	$(V_{TRIP-GND} - V_{LL-PGND})$ voltage $V_{TRIP-GND} = 60\text{mV}$ , $V_{EN\_PSV} = \text{FLOAT}$	-9.5	0.5	10.5	mV
$V_{ZC(off)}$	Zero crossing comparator offset	$V_{PGND-LL}$ voltage, $V_{EN\_PSV} = 3.3\text{V}$	-9.5	0.5	10.5	mV
$V_{RTRIP}$	Current limit threshold setting range	$V_{TRIP-GND}$ voltage <sup>(2)</sup> , $T_A = 25^\circ\text{C}$	30			mV
$I_{TRIP}$	TRIP source current	$V_{TRIP} < 0.3\text{V}$ , $T_A = 25^\circ\text{C}$	9	10	11	$\mu\text{A}$
$TC_{ITRIP}$	Trip source current temperature coefficient	$T_A = 25^\circ\text{C}^{(2)}$		4500		ppm/ $^\circ\text{C}$

(1) Design constraint. Ensure actual on-time is greater than the maximum value (design  $R_{T(on)}$ ) so that the minimum tolerance is 100 k $\Omega$ .

(2) Ensured by design. Not production tested.

**ELECTRICAL CHARACTERISTICS (continued)**

over recommended free-air temperature range (unless otherwise noted)

PARAMETER		CONDITIONS	MIN	TYP	MAX	UNIT
<b>POWERGOOD COMPARATOR</b>						
V <sub>TH(PG)</sub>	Powergood threshold	PG in from lower (PGOOD goes high), T <sub>A</sub> = 25°C	92.5%	95%	97.5%	
		PG Low hysteresis (PGOOD goes low)	–4.5%	–5.5%	–6.5%	
		PG in from higher (PGOOD goes high), T <sub>A</sub> = 25°C	102.5%	105%	107.5%	
		PG High hysteresis (PGOOD goes low)	4.5%	5.5%	6.5%	
I <sub>PG(max)</sub>	Powergood sink current	V <sub>PGOOD</sub> = 0.5 V	2.5	7.5		mA
T <sub>PGDEL</sub>	PGOOD delay	Delay for PGOOD in		64		µs
<b>UVLO / LOGIC THRESHOLD</b>						
V <sub>UVLO</sub>	V5FILT UVLO threshold	Wake up (UVLO out)	3.4	3.7	3.9	V
		Hysteresis	200	300	400	mV
V <sub>EN_PSV</sub>	EN_PSV connection	SKIP mode enabled		3.3V		
		PWM-Only mode enabled		FLOAT		
V <sub>EN_PSV</sub>	EN_PSV logic input voltage	EN_PSV low	0.7	1	1.3	V
		Hysteresis	130	160	220	mV
		EN_PSV float	1.70	1.95	2.25	V
		EN_PSV high	2.2	2.5	2.9	V
		Hysteresis	100	170	250	mV
<b>PROTECTION: OVERVOLTAGE (OVP) AND UNDERVOLTAGE (UVP)</b>						
V <sub>OVP</sub>	VFB OVP trip threshold	OVP detect	110%	115%	120%	
		Hysteresis		5%		
V <sub>UVP</sub>	VFB UVP trip threshold	UVP detect	65%	70%	75%	
		Hysteresis		10%		
T <sub>UVPDEL</sub>	VFB UVP delay			32		µs
T <sub>UVPEN</sub>	Output UVP enable delay			2		ms
<b>THERMAL SHUTDOWN</b>						
T <sub>SDN</sub>	Thermal SDN threshold	Shutdown temperature <sup>(3)</sup>	145	160	175	°C
		Hysteresis <sup>(3)</sup>	10	12	14	°C
<b>INTEGRATED MOSFET</b>						
R <sub>DS(on)upper</sub>	Upper MOSFET R <sub>DS(on)</sub>	See <sup>(3)</sup>		19		mΩ
R <sub>DS(on)lower</sub>	Lower MOSFET R <sub>DS(on)</sub>	See <sup>(3)</sup>		7		mΩ

(3) Ensured by design. Not production tested.

## PIN DESCRIPTIONS

PIN		I/O	DESCRIPTION
NAME	NO.		
EN_PSV	34	I	Enable/power-save pin. Connect to ground to disable switched-mode power supply (SMPS). Connect to 3.3 V or 5 V to turn on SMPS and enable skip mode. Float to turn on SMPS but disable skip mode (forced continuous conduction mode).
GND	1	I	Signal ground pin.
	2		
	4		
LL	16	I/O	Source node of the high-side power FET and drain node of the low-side power FET. Connect this pin to output inductor.
	17		
	18		
	19		
	20		
	21		
	22		
	23		
	24		
	25		
NC	29	—	No connection inside. Leave open.
	33		
PGND	3	I/O	Power GND. Source node of the low-side power FET.
	5		
	6		
	7		
	8		
	9		
PGOOD	40	O	Power-good window comparator: open drain output. Pull up to 5-V rail with a pull-up resistor. Current capability is 7.5 mA.
TON	35	I	On-time / frequency adjustment pin. Connect to LL with proper resistor to program switching frequency.
TRIP	32	I	Overcurrent trip point set input. Connect resistor from this pin to signal ground to set threshold for both overcurrent and negative overcurrent limit.
V5FILT	38	I	5-V power supply input for all control circuitry except gate drivers. Apply an R-C filter to reject high-frequency switching noise.
V5IN	31	I	5-V Power supply input for FET gate drivers. Internally connected to VBST by a PN diode. Connect a capacitor with a value of 1 $\mu$ F or greater between this pin and PGND to support instantaneous current for gate drivers.
VBST	30	I	Supply input for high-side FET gate driver (boost terminal). Connect capacitor from this pin to LL-node. An internal PN diode is connected between V5IN to this pin. Add an external schottky diode if forward drop is critical to ensure efficient operation.
VFB	39	I	SMPS voltage feedback input. Connect the resistor divider here for adjustable output.
VIN	11	I	Input power source. Drain node of the high-side power FET.
	12		
	13		
	14		
	15		
VOUT	36	I	Connect to SMPS output. This terminal serves as the output voltage monitor for on-time adjustment.
VOUT_DS	37	O	Prebias start-up and selectable output discharge. It is also the input for the output discharge switch.

**QFN PACKAGE  
(TOP VIEW)**

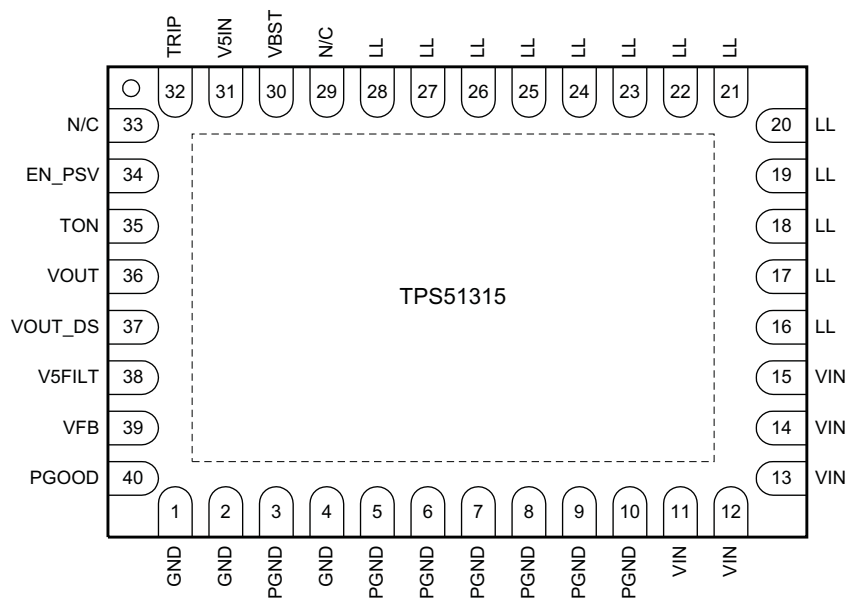

FUNCTIONAL BLOCK DIAGRAM

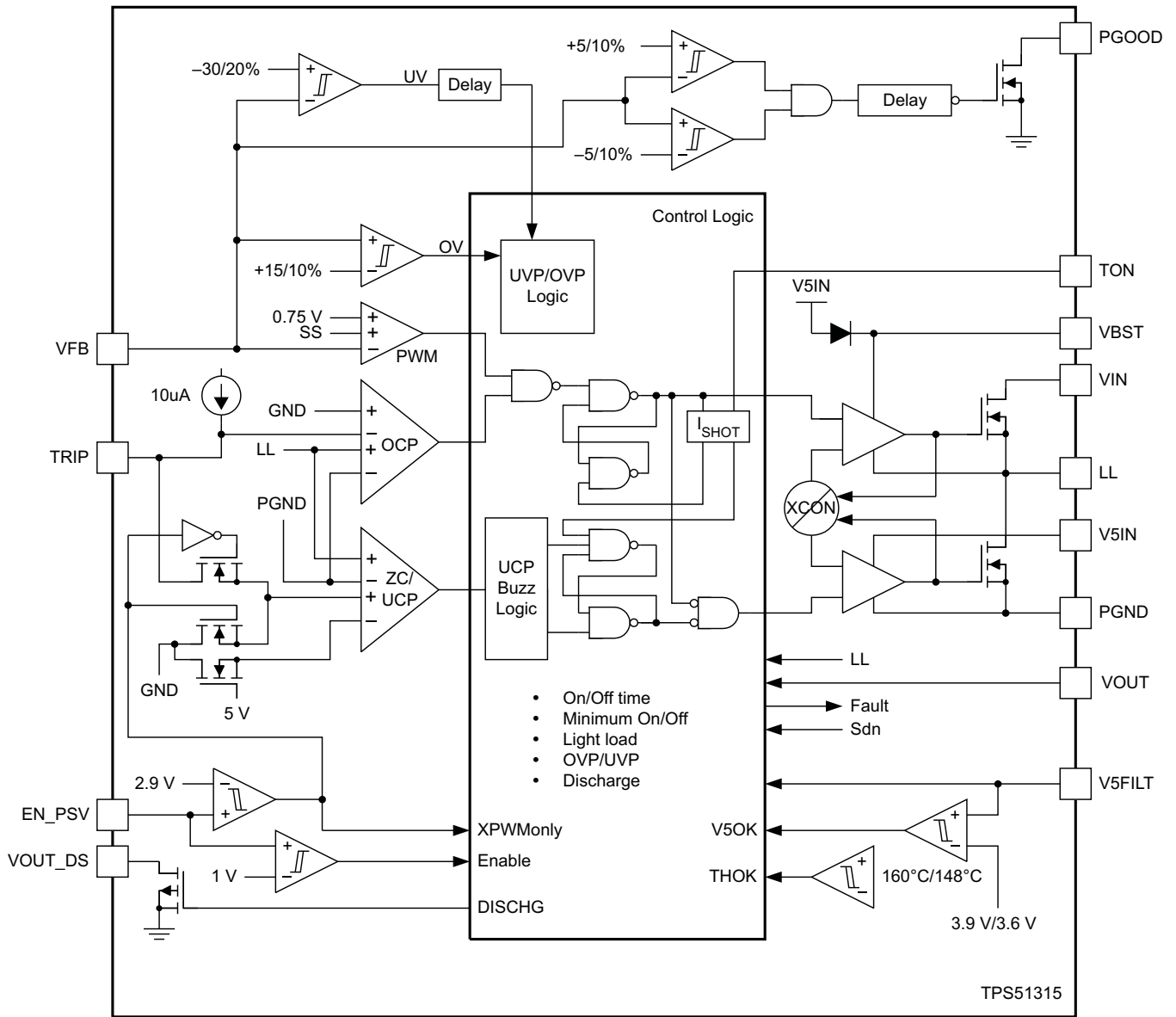

UDG-09048



## DETAILED DESCRIPTION

### Dual PWM Operations

The primary control loop of the switched-mode power supply (SMPS) functions as an adaptive on-time pulse width modulation (PWM) controller. It supports a proprietary D-CAP™ mode. D-CAP™ mode uses an internal compensation circuit and is suitable for a low external component count configuration with an appropriate amount of equivalent series resistance (ESR) at the output capacitor(s). The output voltage is monitored at a feedback point voltage.

At the beginning of each cycle, the upper synchronous MOSFET is turned on, or enters the ON state. This MOSFET is turned off, or enters the OFF state, after an internal one-shot timer expires. This one shot is determined by the input voltage ( $V_{IN}$ ) and the output voltage ( $V_{OUT}$ ) to maintain a relatively constant frequency over the input voltage range. This is called *adaptive on-time control* (see *PWM Frequency and Adaptive On-Time Control* section). The MOSFET is turned on again when feedback indicates an insufficient output voltage and the inductor current falls below the overcurrent limit. By repeating the operation in this manner, the controller regulates the output voltage. The synchronous lower (rectifying) MOSFET is turned on at each OFF state in order to minimize the conduction losses.

The TPS51315 supports both PWM-Only and Auto-Skip operating modes. When the EN\_PSV pin is grounded, the switcher is disabled. When the EN\_PSV pin is connected to a 3.3-V supply or a 5-V supply, Auto-Skip mode is enabled. The rectifying MOSFET is turned off when the inductor current is zero. This feature enables a seamless transition to the reduced-frequency operation at light load conditions so that high efficiency is maintained over a broad range of load currents. When the EN\_PSV pin is floated, it is internally pulled up to 1.9 V, and PWM-Only mode is enabled. In this mode, the rectifying MOSFET is not turned off when the inductor current reaches zero, and so the switching frequency does not change at light load; however the efficiency is lower in PWM-Only mode than it is in Auto-Skip mode.

The dc output voltage can be set by the external resistor divider as shown in [Equation 1](#).

$$V_{OUT} = \left( 1 + \frac{R_{UPPER}}{R_{LOWER}} \right) \times 0.75 \text{ V} \quad (1)$$

### Light Load Conditions

When Auto-Skip mode is enabled, the TPS51315 automatically reduces the switching frequency under light load conditions to maintain high efficiency.

As the output current decreases from a heavy load condition, the inductor current is also reduced and eventually its *valley* falls to zero current, which is the boundary between continuous conduction and discontinuous conduction modes. The rectifying MOSFET is turned off when zero inductor current is detected. As the load current continues to decrease, the converter runs in discontinuous conduction mode, taking longer to discharge the output capacitor toward the reference voltage. The on-time maintains the same as when under a heavy load condition. Alternatively, when the output current increase from light load to heavy load, switching frequency increases to the preset value as the inductor current reaches the continuous conduction threshold. The transition load point to the light load operation  $I_{OUT(LL)}$  (that is, the threshold between continuous and discontinuous conduction mode) can be calculated using [Equation 2](#).

$$I_{OUT(LL)} = \frac{1}{2 \times L \times f} \times \frac{(V_{IN} - V_{OUT}) \times V_{OUT}}{V_{IN}} \quad (2)$$

where

- $f$  is the PWM switching frequency

Switching frequency versus output current under light load conditions is a function of  $L$ ,  $f$ ,  $V_{IN}$  and  $V_{OUT}$ , but it decreases almost proportionally to the output current from  $I_{OUT(LL)}$  as calculated in [Equation 2](#). For example, it is approximately 60 kHz at  $I_{OUT(LL)}/5$  when the PWM frequency is 300 kHz.

## PWM Frequency and Adaptive On Time Control

TPS51315 employs an adaptive on-time control scheme and does not include a dedicated oscillator on the device. However, the device runs with pseudo-constant frequency by feed-forwarding the input voltage and output voltage to the on-time, one-shot timer. The on-time control is inversely proportional to the input voltage and proportional to the output voltage, so that the duty ratio is maintained as  $V_{OUT}/V_{IN}$  with the same cycle time, as shown in [Equation 3](#).

$$T_{ON} = 19 \times 10^{-12} \times R_{T(on)} \left( \frac{(2/3)V_{OUT} + 100\text{mV}}{V_{IN}} \right) + 50\text{ns} \quad (3)$$

where

- $R_{T(on)}$  is the external resistor connected from  $T_{ON}$  to LL

For the TPS51315, the input voltage is monitored at the LL pin during the ON state. An advantage of switching-node monitoring is that any loss in the high-side n-channel FET becomes part of the on-time calculation, thereby making the frequency more stable with load.

Another consideration regarding frequency is jitter. Jitter may have many causes, but the constant on-time D-CAP mode scheme has some amount of inherent jitter. Because the output voltage ripple height is in the range of approximately 20 mV, on the order of a milli-volt of noise on the feedback signal can affect the frequency between approximately 3% and 10%. This is normal operation and risks only a small amount of influence to the power supply performance.

## Soft-Start

The TPS51315 includes an independent, internal, 1.06-ms, voltage servo soft-start function with overcurrent limit. When the EN\_PSV pin goes high, an internal digital-to-analog converter (DAC) begins ramping up the reference voltage to the error amplifier. Smooth control of the output voltage is maintained during start-up.

## Powergood

The TPS51315 includes a powergood output function. The powergood function is activated after the soft-start function has completed. If the output voltage comes within  $\pm 5\%$  of the target value, internal comparators detect a powergood state and the powergood signal becomes high after a 64- $\mu\text{s}$  internal delay. If the output voltage rises above or falls below 10% of the target value, the powergood signal goes low immediately.

## Output Discharge Control

The TPS51315 discharges output when EN\_PSV is low or when the channel is in either a UVP or OVP fault condition. The TPS51315 discharges output using an internal 20- $\Omega$  MOSFET that is connected to VOUT\_DS and PGND. The current capability of the MOSFET is limited to discharge slowly. An external resistor can be connected between VOUT\_DS and VOUT to program discharge slow rate. In case the discharge function is not wanted, leave VOUT\_DS open.

## Overcurrent Limit

The TPS51315 has cycle-by-cycle overcurrent limit function. The inductor current is monitored during the OFF state using the low-side FET  $R_{DS(on)}$  which is 7 m $\Omega$  (typ). The controller maintains the OFF state and does not release next ON cycle until the detected current comes down to the overcurrent trip level set by the TRIP resistor. Because of this scheme,  $R_{TRIP}$  establishes the valley level of the inductor current. Note that the load current at the overcurrent threshold,  $I_{OCL}$ , is higher than this value calculated in [Equation 4](#).

$$V_{TRIP} = \left( I_{OCL} - \left( \frac{I_{RIPPLE}}{2} \right) \right) \times 7 \text{ m}\Omega \quad (4)$$

$R_{TRIP}$  value can be calculated by [Equation 5](#), but cannot exceed 12.1-k $\Omega$  to protect the internal FETs from overloading.

$$R_{TRIP} = \frac{V_{TRIP}}{10 \mu\text{A}} \quad (5)$$

## Undercurrent Limit

The TPS51315 also supports a cycle-by-cycle undercurrent limit in PWM-Only mode. The undercurrent limit is the negative value of the overcurrent limit. If the output voltage continues to rise, the lower MOSFET is always on: thus, the inductor current reduces and reverses direction after it reaches zero (in PWM-Only mode). When there is too much negative current through the inductor, the lower MOSFET is turned off and the current flows to the VIN pin through the body diode of the upper MOSFET. Because there is less current with which to discharge the output capacitor, output voltage tends to rise, eventually reaching the overvoltage protection threshold and shutting down the TPS51315. In order to prevent triggering a false OVP shut down, the lower MOSFET is turned on 400-ns after it is turned off. If the device reaches an undercurrent threshold again before the output voltage is discharged to the target level, the lower MOSFET is turned off and the process repeats. This logic is called *UCL Buzz*. It ensures maximum allowable discharge capability when the output voltage continues to rise. Alternatively, if the output voltage is discharged to the target level before the UCL threshold is reached, the lower MOSFET is turned off, the upper MOSFET is then turned on, and the device resumes normal operation.

## Overvoltage Protection

The TPS51315 monitors a resistor-divided feedback voltage to detect overvoltage and undervoltage conditions. When the feedback voltage becomes greater than 115% of the target value, the upper MOSFET is turned off and the lower MOSFET is turned on immediately. The output is also discharged by the internal 20- $\Omega$  transistor if it is connected to VOUT\_DS.

The TPS51315 monitors the output voltage directly. If it becomes greater than 5.75 V, TPS51315 turns off the upper MOSFET driver. In no case should the device operate at more than 6 V, as damage would occur.

## Undervoltage Protection

When the feedback voltage becomes lower than 70% of the target value, the undervoltage comparator output goes high and an internal UVP delay counter begins to increment. After 32  $\mu\text{s}$ , TPS51315 latches off both the upper and lower MOSFETs and discharges the output with the internal 20- $\Omega$  transistor if it is connected to VOUT\_DS. This function is enabled after 2ms from when EN\_PSV is brought high, i.e., UVP is disabled during the start up.

## UVLO Protection

The TPS51315 has V5FILT undervoltage lockout (UVLO) protection. When the V5FILT voltage is lower than UVLO threshold voltage, TPS51315 is shut off. This protection is not latched.

## Thermal Shutdown

The TPS51315 includes a die-temperature monitor function. If the temperature exceeds the threshold value (typically 160°C), TPS51315 shutd off. This protection is not latched. The device recovers once the temperature has cooled to 148C.

**TYPICAL CHARACTERISTICS**

At  $V_{IN} = 12\text{ V}$ ,  $V_{V5IN} = 5\text{ V}$ ,  $R_{T(on)} = 237\text{ k}\Omega$ , and  $T_A = 25^\circ\text{C}$ , unless otherwise noted.

**PWM SUPPLY CURRENT  
VS  
JUNCTION TEMPERATURE**

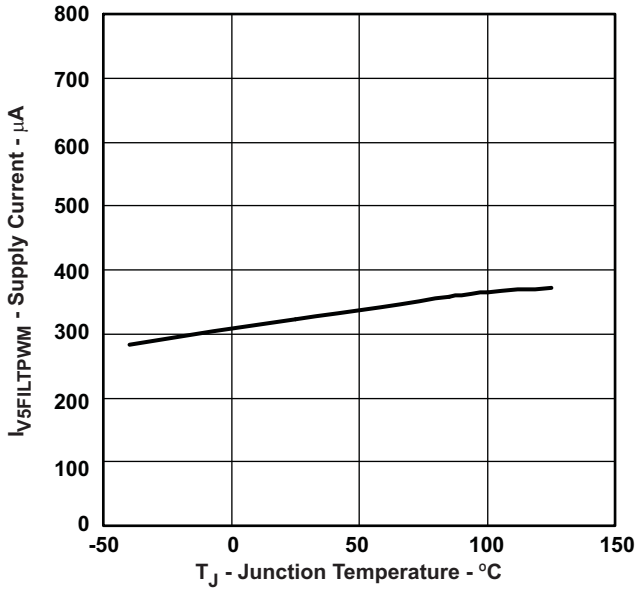

Figure 1.

**V5FILT SHUTDOWN CURRENT  
VS  
JUNCTION TEMPERATURE**

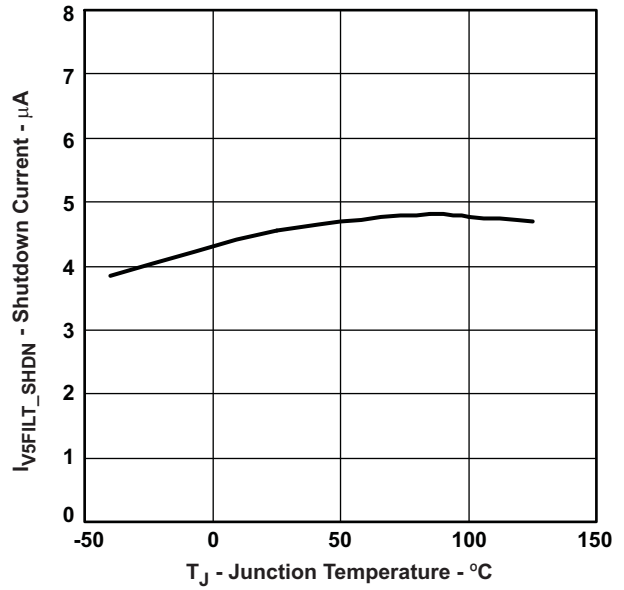

Figure 2.

**TRIP CURRENT  
VS  
JUNCTION TEMPERATURE**

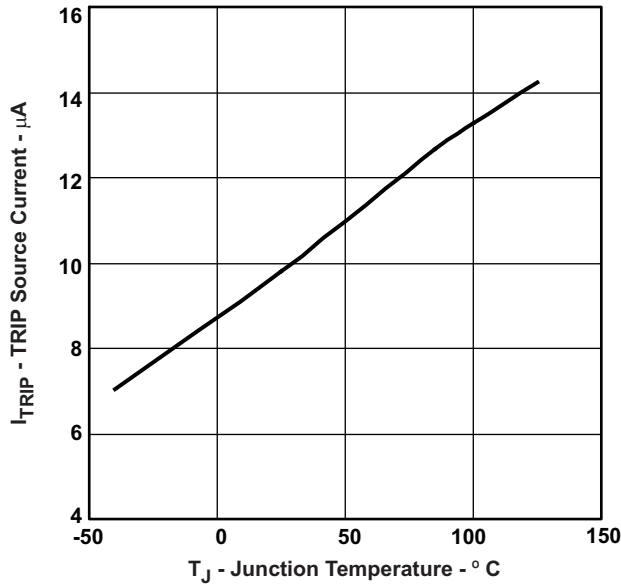

Figure 3.

**OVP/UVP THRESHOLD  
VS  
JUNCTION TEMPERATURE**

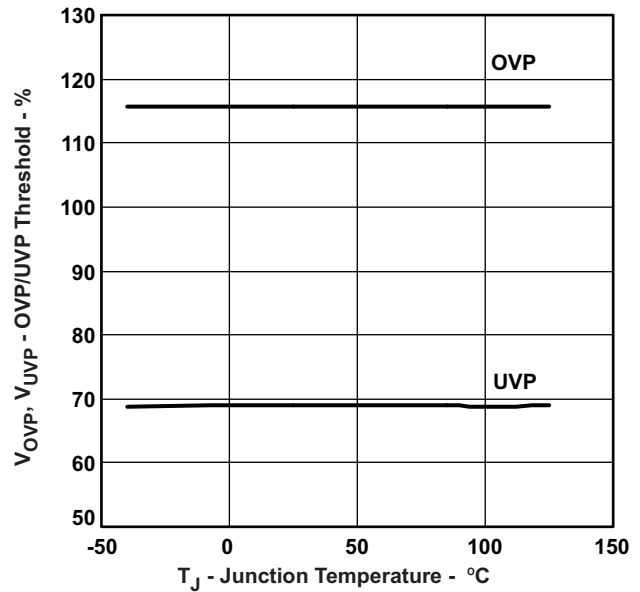

Figure 4.

TYPICAL CHARACTERISTICS (continued)

At  $V_{IN} = 12\text{ V}$ ,  $V_{V5IN} = 5\text{ V}$ ,  $R_{T(on)} = 237\text{ k}\Omega$ , and  $T_A = 25^\circ\text{C}$ , unless otherwise noted.

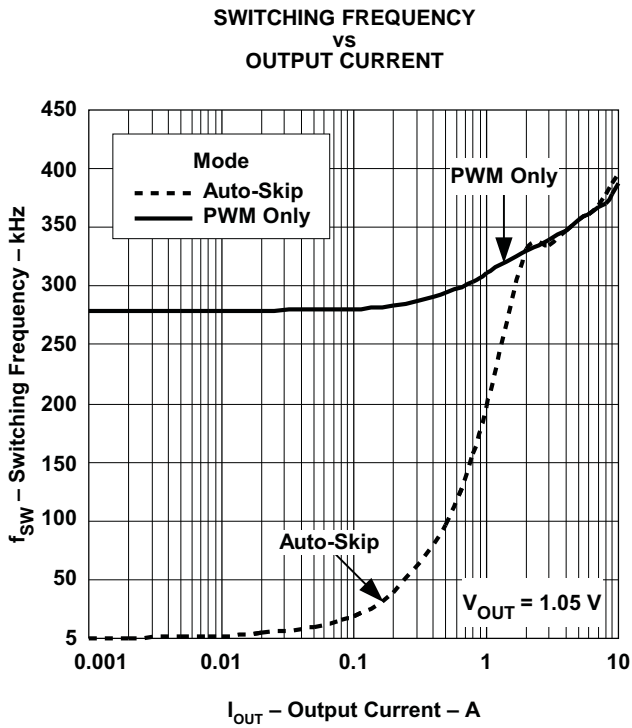

Figure 5.

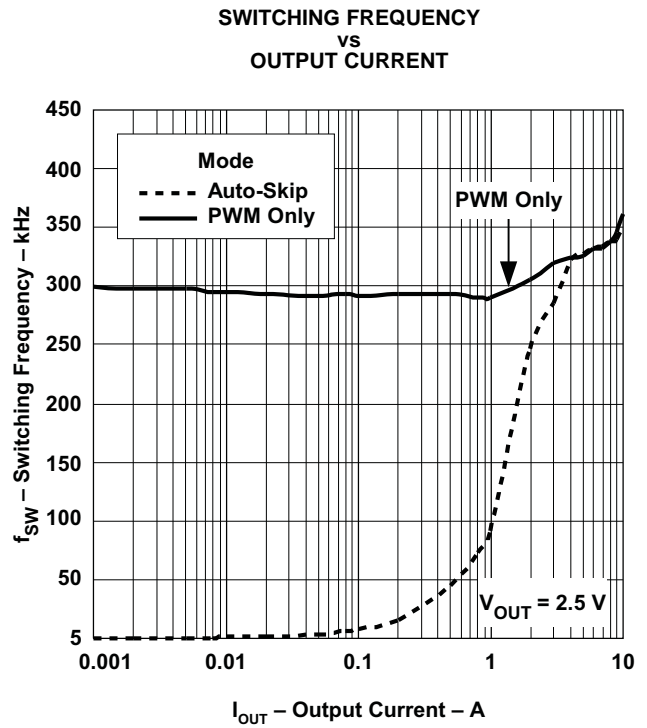

Figure 6.

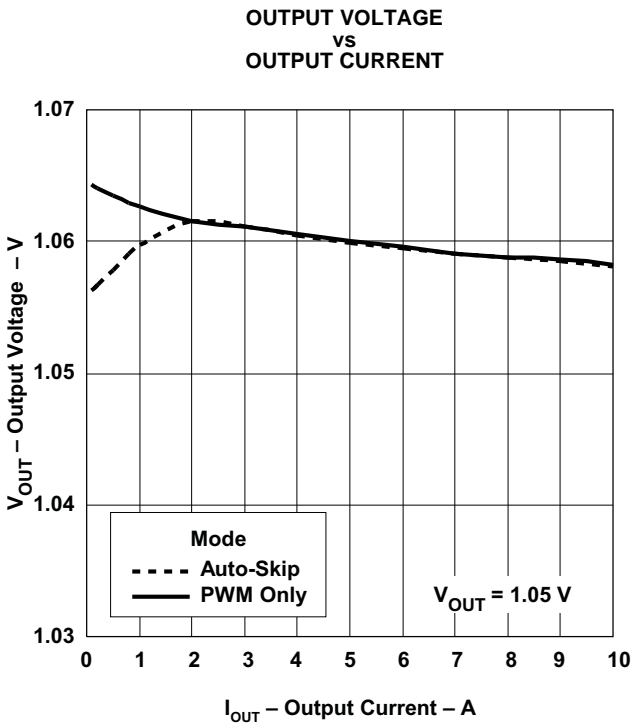

Figure 7.

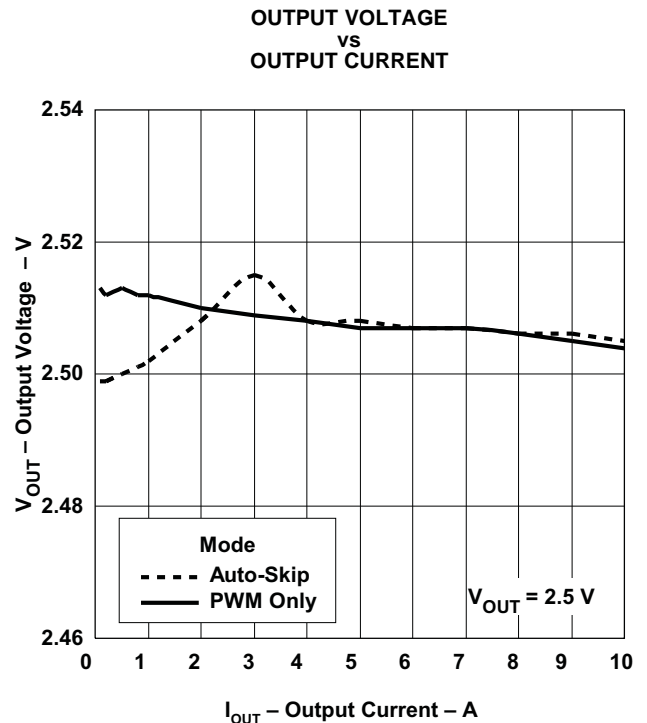

Figure 8.

**TYPICAL CHARACTERISTICS (continued)**

At  $V_{IN} = 12\text{ V}$ ,  $V_{V5IN} = 5\text{ V}$ ,  $R_{T(on)} = 237\text{ k}\Omega$ , and  $T_A = 25^\circ\text{C}$ , unless otherwise noted.

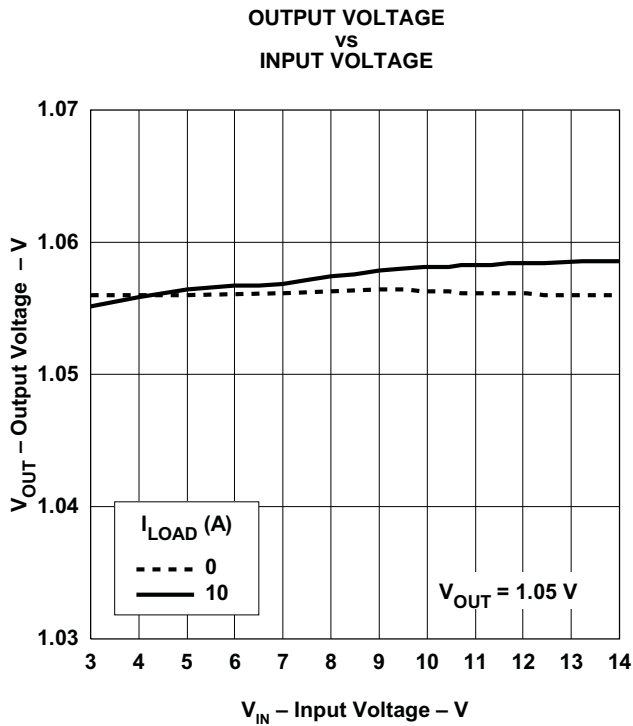

Figure 9.

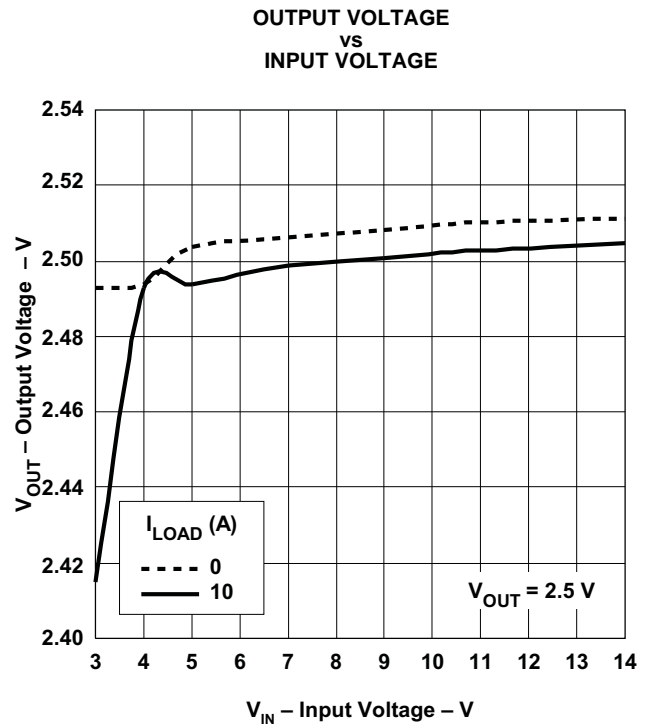

Figure 10.

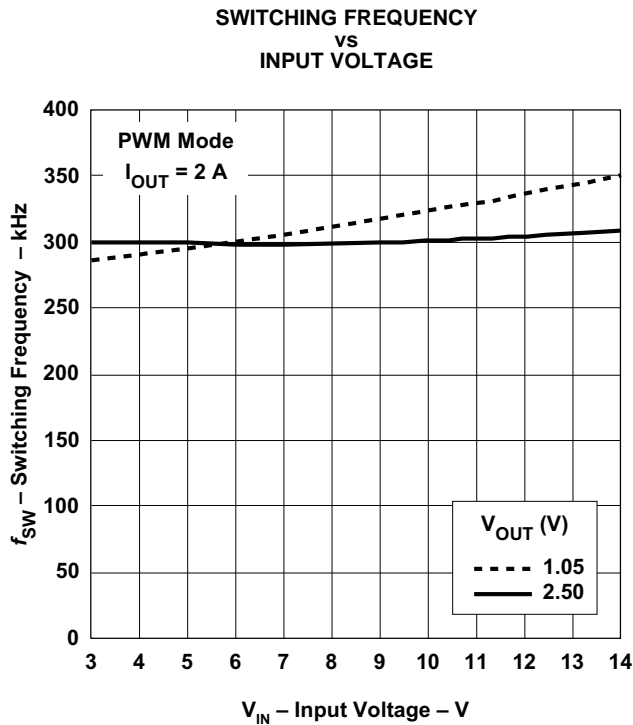

Figure 11.

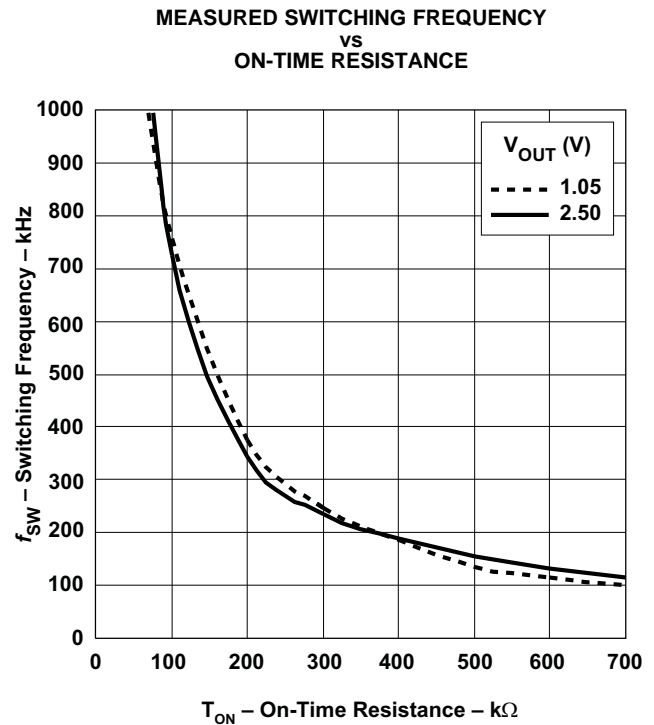

Figure 12.

TYPICAL CHARACTERISTICS (continued)

At  $V_{IN} = 12\text{ V}$ ,  $V_{VIN} = 5\text{ V}$ ,  $R_{T(on)} = 237\text{ k}\Omega$ , and  $T_A = 25^\circ\text{C}$ , unless otherwise noted.

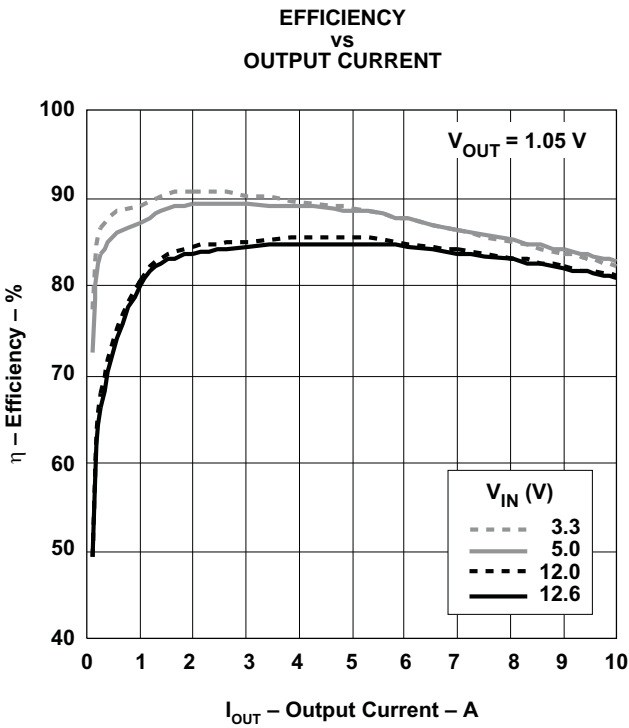

Figure 13.

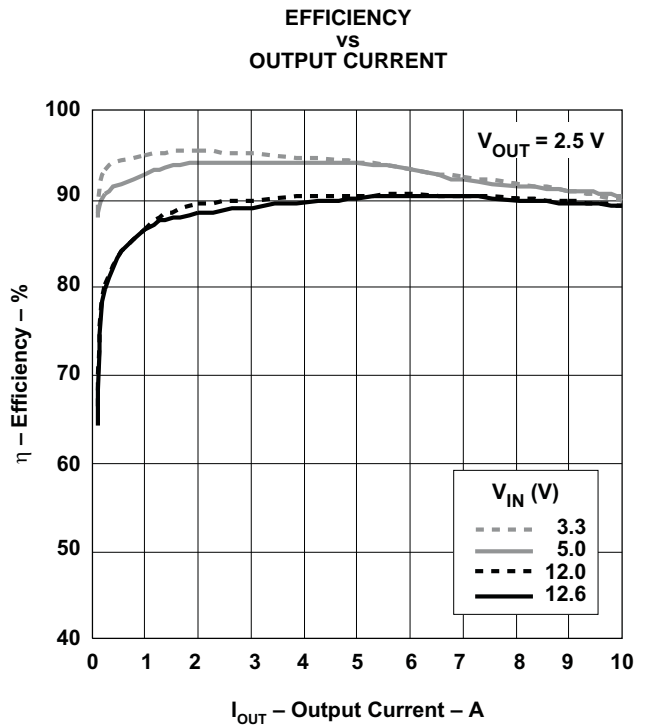

Figure 14.

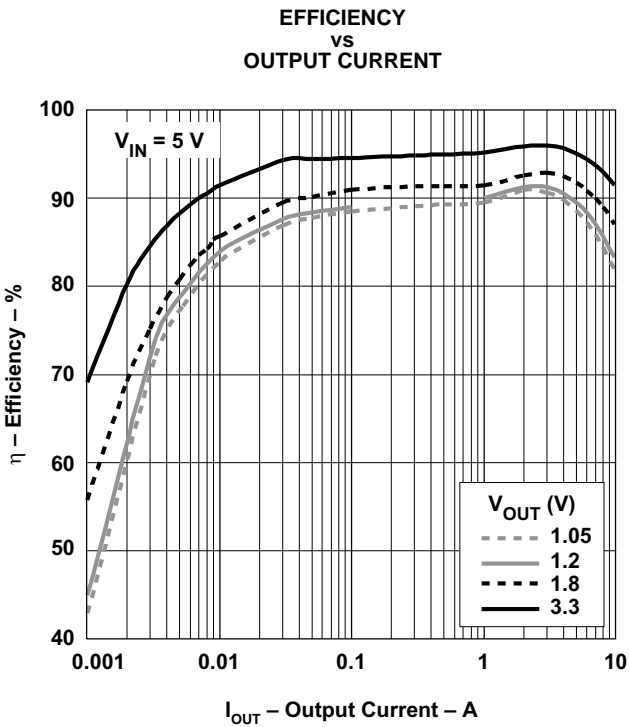

Figure 15.

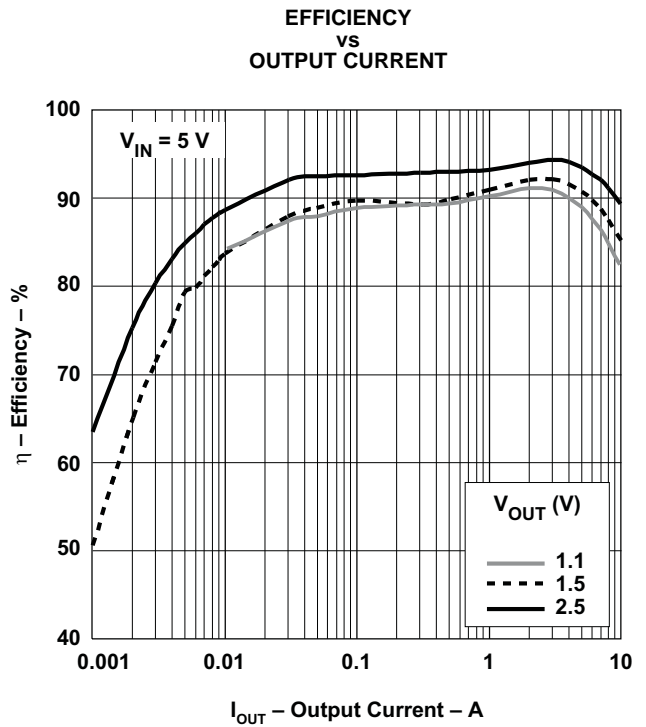

Figure 16.

TYPICAL CHARACTERISTICS (continued)

At  $V_{IN} = 12\text{ V}$ ,  $V_{VIN} = 5\text{ V}$ ,  $R_{T(on)} = 237\text{ k}\Omega$ , and  $T_A = 25^\circ\text{C}$ , unless otherwise noted.

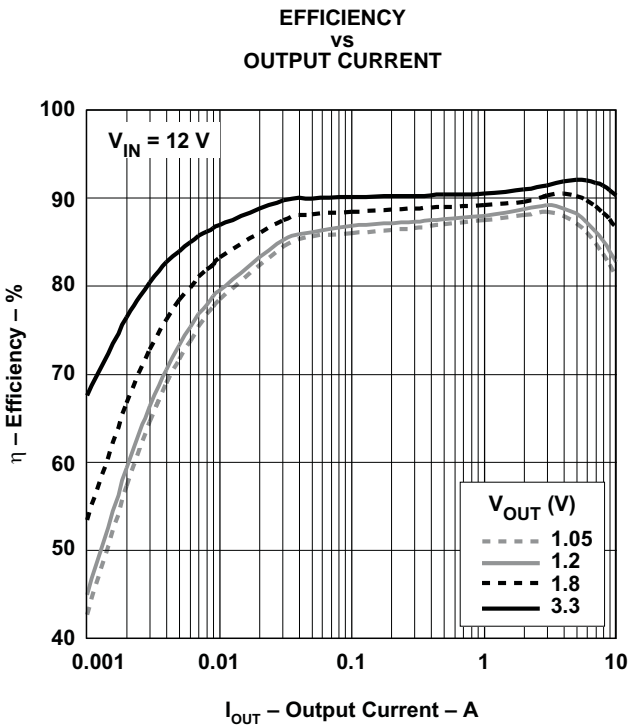

Figure 17.

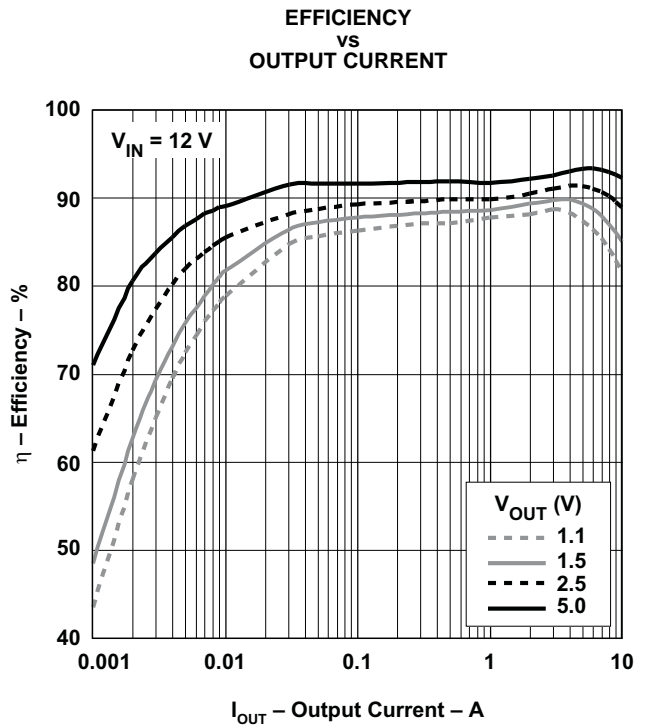

Figure 18.

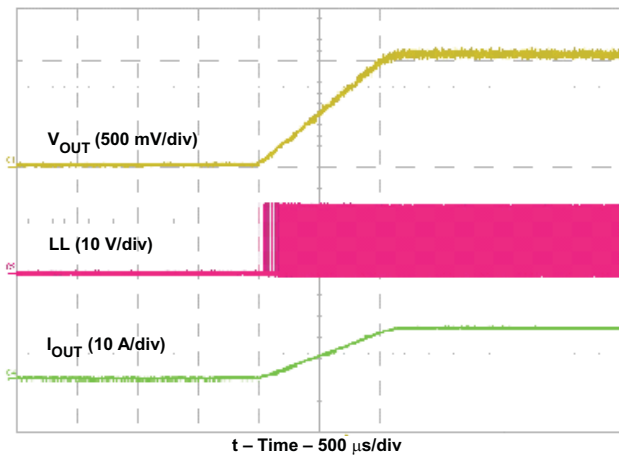

Figure 19. 1.05-V Start-Up Waveforms (Heavy Load)

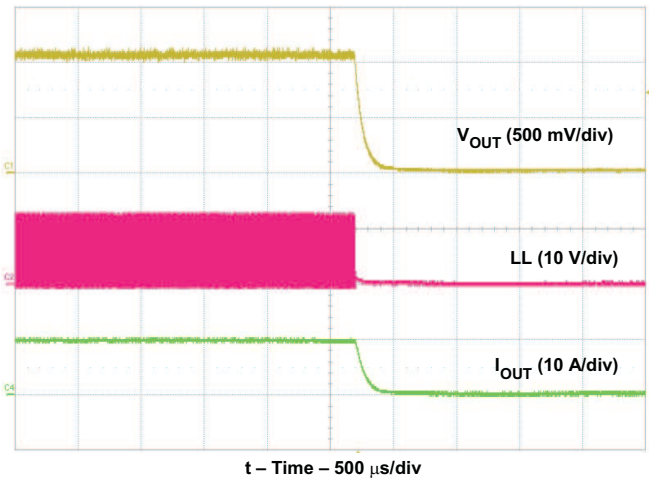

Figure 20. 1.05-V Shut-Down Waveforms (Heavy Load)



TYPICAL CHARACTERISTICS (continued)

At  $V_{IN} = 12\text{ V}$ ,  $V_{VIN} = 5\text{ V}$ ,  $R_{T(on)} = 237\text{ k}\Omega$ , and  $T_A = 25^\circ\text{C}$ , unless otherwise noted.

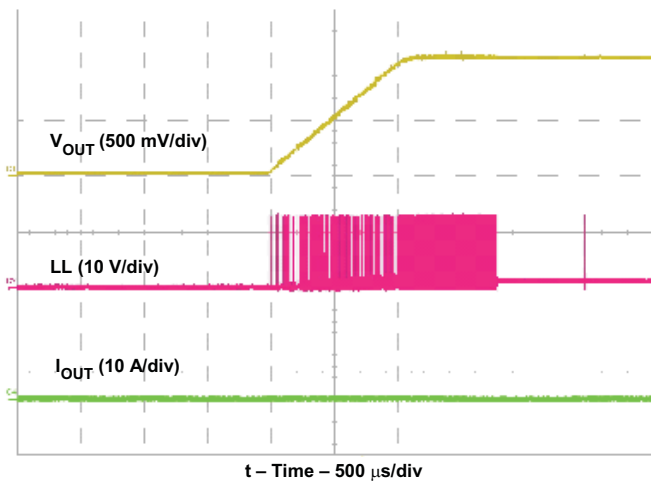

Figure 21. 1.05-V Start-Up Waveforms (Light Load)

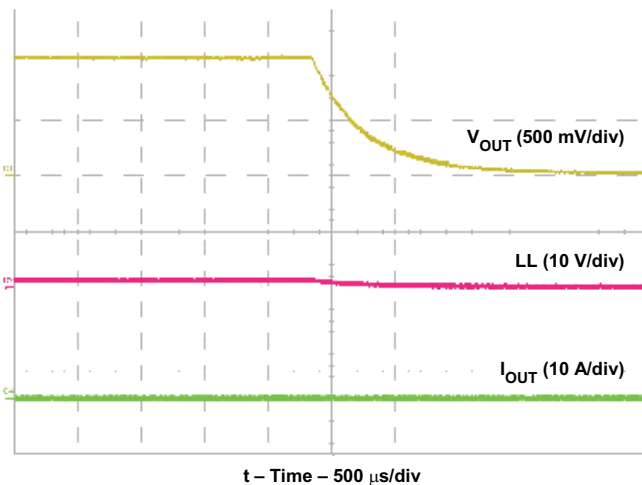

Figure 22. 1.05-V Shut-Down Waveforms (Light Load)

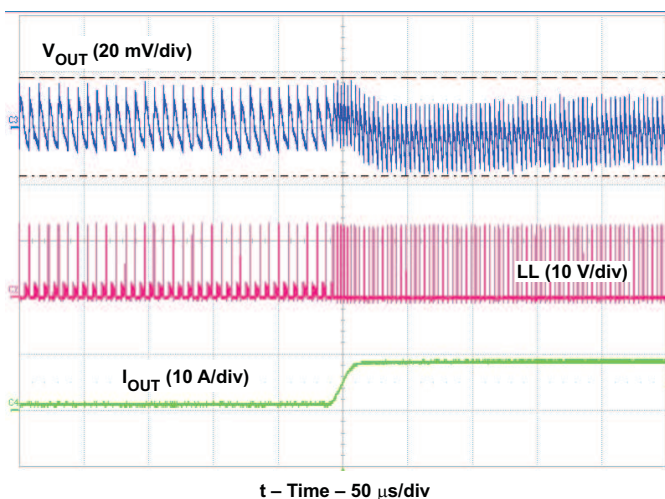

Figure 23. 1.05-V Load Step-Up Waveforms

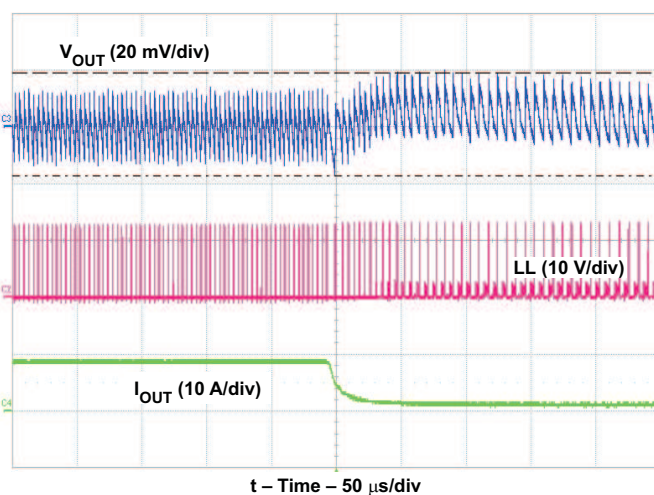
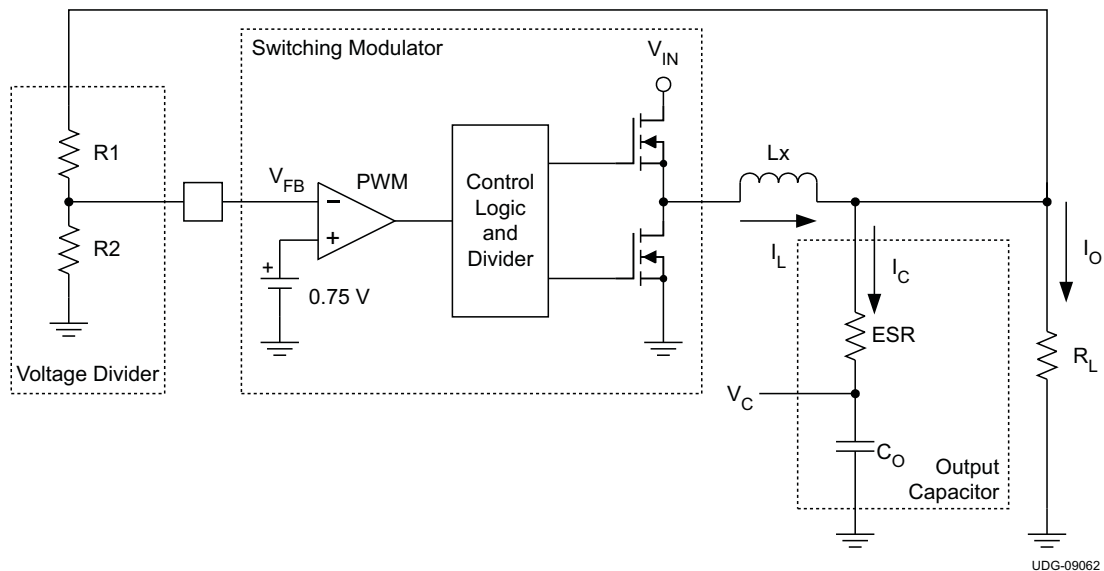

Figure 24. 1.05-V Load Step-Down Waveforms

## APPLICATION INFORMATION

### Loop Compensation and External Parts Selection



**Figure 25. Simplified Modulator Block Diagram**

The feedback voltage ( $V_{VFB}$ ) is compared to the internal reference voltage after the divider resistors. The PWM comparator determines when to turn on the upper MOSFET. The gain and speed of the comparator is high enough to maintain the voltage level relatively constant at the beginning of each on cycle, or at the end of each off cycle. The dc output voltage may have line regulation due to ripple amplitude that slightly increases as the input voltage increases.

For loop stability, the 0 dB frequency,  $f_0$ , defined in Equation 6 must be lower than 1/4 of the switching frequency.

$$f_0 = \frac{1}{2\pi \times \text{ESR} \times C_{\text{OUT}}} \leq \frac{f_{\text{SW}}}{4} \quad (6)$$

Because  $f_0$  is determined solely by the output capacitor characteristics, the loop stability of the D-CAP™ Mode is determined by capacitor chemistry. For example, specialty polymer capacitors (SP-CAP) have an output capacitance on the order of several hundred micro-farads and an ESR of approximately 10 mΩ. These values make  $f_0$  on the order of 100 kHz or less and create a stable loop. However, ceramic capacitors have an  $f_0$  of more than 700 kHz, which is not suitable for this operating mode, although the D-CAP™ Mode provides many advantages such as ease-of-use, minimum external component configuration, and extremely short response time. These advantages are realized because there is no error amplifier in the loop, so a sufficient feedback signal is required from an external circuit to reduce the jitter level. The required signal level is approximately 15 mV at the comparing point. This generates output ripple at the output node that can be calculated in Equation 7. The output capacitor ESR should meet this requirement.

$$V_{\text{RIPPLE}} = \left( \frac{V_{\text{OUT}}}{0.75} \right) \times 15 \text{ mV} \quad (7)$$

For applications with all ceramic output capacitors, a few external components need to be added to ensure the loop stability. Please refer to Figure 29. Since ceramic capacitors have low ESR, feedback ripple in phase with inductor current is recommended. R-C network across the output inductor can mimic inductor current when  $RC \approx L / \text{DCR}$ , the ripple current can be coupled to the feedback through a 1-μF capacitor.

## External Component Selection

External component selection is a simple process in D-CAP™ Mode.

1. Determine the value of R1 and R2.

The recommended R2 value is 10 kΩ to 100 kΩ. Calculate R1 by using [Equation 8](#).

$$R1 = \frac{V_{OUT} - 0.75}{0.75} \times R2 \quad (8)$$

2. Choose  $R_{T(on)}$

The switching frequency is usually determined by overall view of the dc-dc converter designer in consideration of size, efficiency or cost, and mostly dictated by external component constraints such as the size of inductor and/or the output capacitor. If an extremely low or high duty factor is expected, the minimum on-time or off-time must also be considered to satisfy the required duty factor. Once the switching frequency is decided,  $R_{T(on)}$  can be determined by [Equation 9](#) and [Equation 10](#).

$$T_{ON(max)} = \frac{1}{f} \times \frac{V_{OUT}}{V_{IN(min)}} \quad (9)$$

$$R_{T(on)} = \frac{3}{2} \times \frac{(T_{ON(max)} - 50ns)}{19 \times 10^{-12}} \times \frac{V_{IN(min)}}{(V_{OUT} + 150mV)} (\Omega) \quad (10)$$

3. Choose the inductor.

To begin, choose an inductance value where the ripple current is approximately 1/4 to 1/2 of the maximum output current.

$$L_{IND} = \frac{1}{I_{IND(ripple)} \times f} \times \frac{(V_{IN(max)} - V_{OUT}) \times V_{OUT}}{V_{IN(max)}} = \frac{3}{I_{OUT(max)} \times f} \times \frac{(V_{IN(max)} - V_{OUT}) \times V_{OUT}}{V_{IN(max)}} \quad (11)$$

For applications that require a fast transient response with a minimum of  $V_{OUT}$  overshoot, consider a smaller inductance value than calculated in [Equation 11](#). The cost of a small inductance value is higher steady-state ripple, larger line regulation, and higher switching loss.

The inductor also needs to have low DCR to achieve good efficiency, as well as enough room above the peak inductor current before saturation. The peak inductor current can be estimated by [Equation 12](#).

$$I_{IND(peak)} = \frac{V_{TRIP}}{R_{DS(on)}} + \frac{1}{2 \times L \times f} \times \frac{(V_{IN(max)} - V_{OUT}) \times V_{OUT}}{V_{IN(max)}} \quad (12)$$

4. Choose output capacitor(s).

Organic semiconductor capacitor(s) or specialty polymer capacitor(s) are recommended. Determine an ESR to meet the required ripple voltage. A quick approximation is shown in [Equation 13](#).

$$ESR = \frac{V_{OUT} \times 0.015}{I_{RIPPLE} \times 0.75} \approx \frac{V_{OUT}}{I_{OUT(max)}} \times 60 (m\Omega) \quad (13)$$

5. Choose an  $R_{TRIP}$  value.

Select an appropriate  $R_{TRIP}$  value with the considerations shown in [Equation 14](#). Maximum  $R_{TRIP}$  should be less than 12.1 k $\Omega$ .

$$R_{TRIP} = \frac{I_{OUT(max)} \times 7 \text{ m}\Omega}{I_{TRIP(min)}} \quad (14)$$

6. V5FILT input capacitor.

In order to reject high-frequency noise possibly contained on +5-V supply and V5IN voltages, apply 1- $\mu$ F of ceramic capacitor closely at the V5FILT pin with a 10- $\Omega$  resistor to create a low-pass filter between +5-V supply and the pin.

7. Applying the VBST capacitor and VBST diode.

Apply 0.1- $\mu$ F MLCC between VBST and the LL node as the flying capacitor for internal high-side FET driver. The TPS51315 has its own on-board boost diode between V5IN and VBST. This diode is a P-N junction diode and strong enough for most typical applications. However, if efficiency has priority over cost, the designer may add a Schottky diode externally to improve the gate drive voltage of the high-side FET. A Schottky diode has a higher leakage current, especially at high temperatures, than a P-N junction diode. A low-leakage diode should be selected in order to maintain VBST voltage during low-frequency operation in Auto-Skip mode.

## Layout Considerations

Certain concepts must be considered before starting printed circuit board (PCB) layout work using the TPS51315.

- Connect the R-C low-pass filter from the 5-V supply to the V5FILT pin. A filter resistance of 10  $\Omega$  and a filter capacitance of 1  $\mu$ F is recommended. Place the filter capacitor close to the device, within 12 mm (0.5 inches) if possible.
- Connect the overcurrent setting resistors from TRIP to GND close to the device if possible. The trace from TRIP to the resistor and from the resistor to GND should avoid coupling to a high-voltage switching node.
- The discharge path ( $V_{OUT\_DS}$ ) should have a dedicated trace to the output capacitor(s); separate from the output voltage sensing trace, and use a 1.5 mm (60 mils) or wider trace with no loops. Make sure the feedback current setting resistor (the resistor between VFB to GND) is tied close to the device GND. The trace from this resistor to the VFB pin should be short and narrow. Place the trace on the component side and avoid vias between this resistor and the device.
- All sensitive analog traces and components such as VOUT, VFB, GND, EN\_PSV, PGOOD, TRIP, V5FILT, and TON should be placed away from high-voltage switching nodes such as LL or VBST to avoid coupling. Use internal layer(s) as ground plane(s) and shield the feedback traces from power traces and components.
- Gather the ground terminals of the  $V_{IN}$  capacitor(s),  $V_{OUT}$  capacitor(s), and the PGND as close as possible. GND (signal ground) and PGND (power ground) should be connected strongly together near the device. The PCB trace defined as LL node, which connects to the source of the upper MOSFET, the drain of the lower MOSFET, and the high-voltage side of the inductor, should be as short and wide as possible.

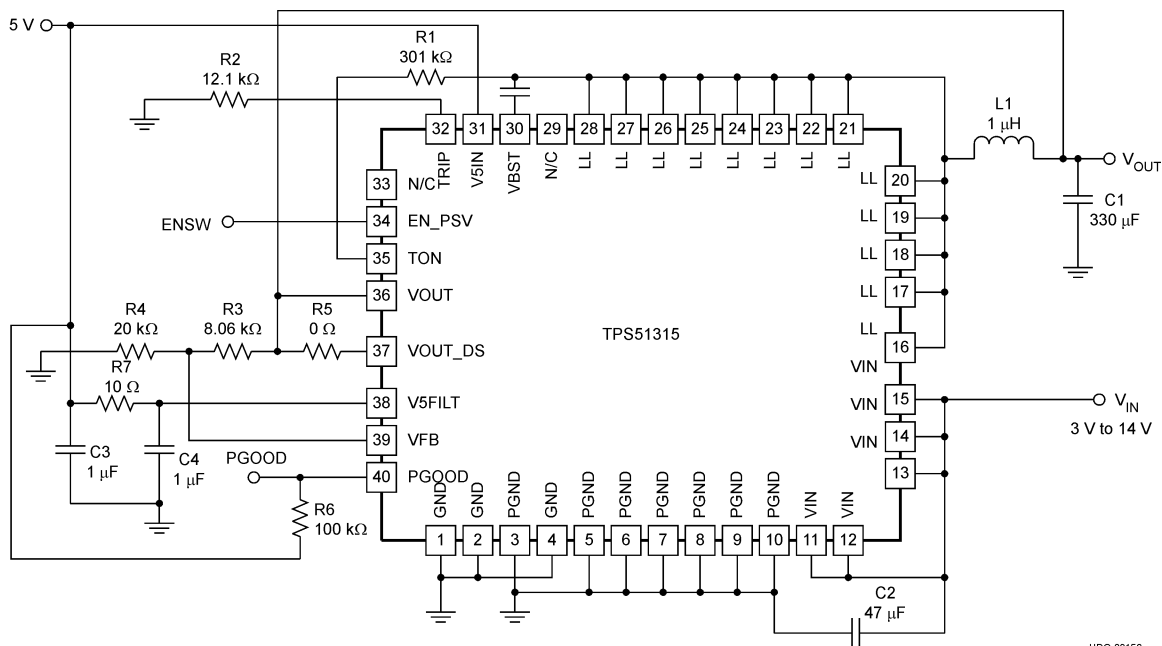

UDG-08156

Figure 26. Typical 1.05-V/10-A Application

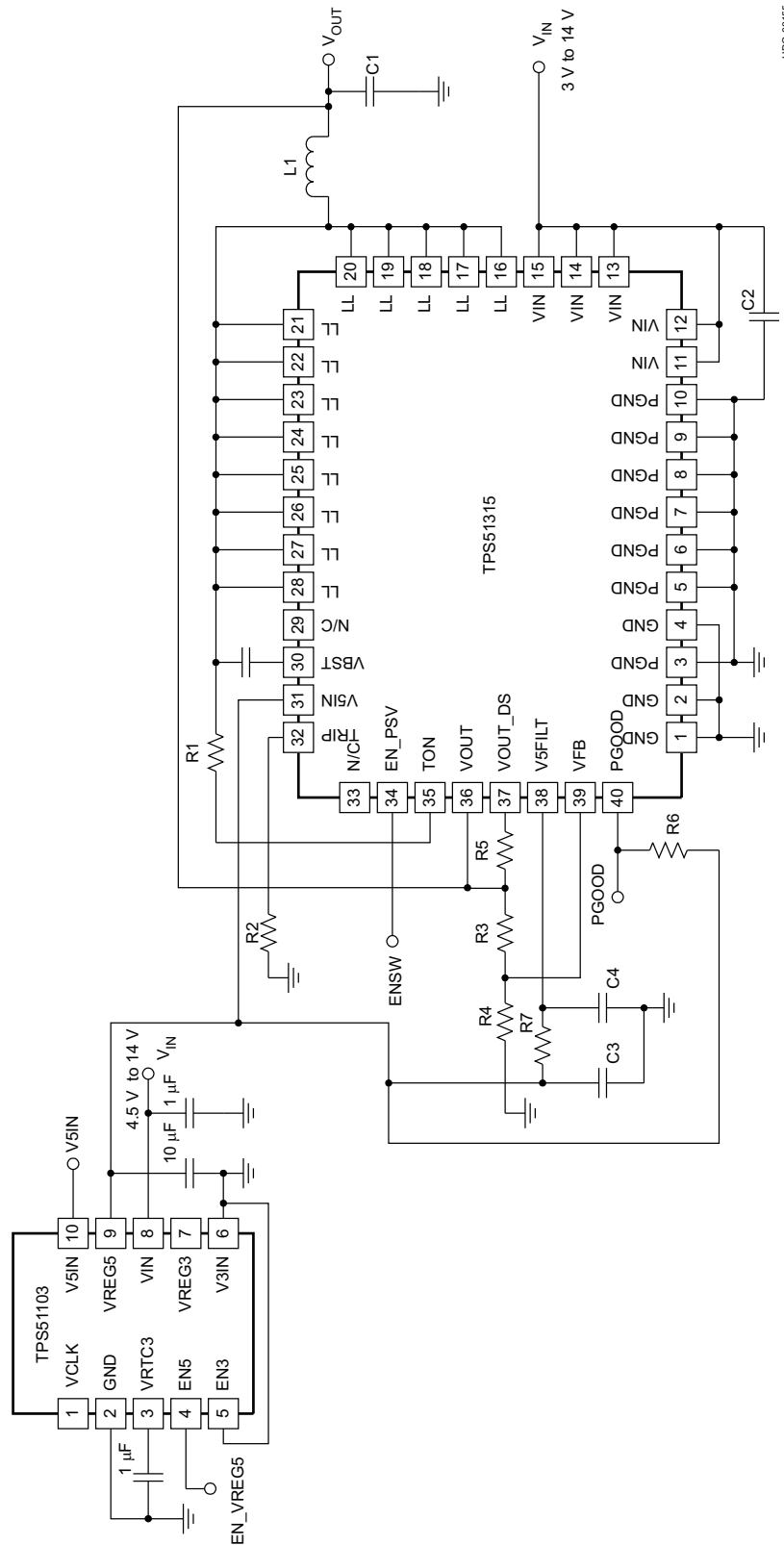

Figure 27. 1.05-V/10-A Applications with TPS51103







**PACKAGING INFORMATION**

Orderable Device	Status <sup>(1)</sup>	Package Type	Package Drawing	Pins	Package Qty	Eco Plan <sup>(2)</sup>	Lead/Ball Finish	MSL Peak Temp <sup>(3)</sup>
TPS51315RGFR	ACTIVE	VQFN	RGF	40	3000	Green (RoHS & no Sb/Br)	CU NIPDAU	Level-2-260C-1 YEAR
TPS51315RGFT	ACTIVE	VQFN	RGF	40	250	Green (RoHS & no Sb/Br)	CU NIPDAU	Level-2-260C-1 YEAR

<sup>(1)</sup> The marketing status values are defined as follows:

**ACTIVE:** Product device recommended for new designs.

**LIFEBUY:** TI has announced that the device will be discontinued, and a lifetime-buy period is in effect.

**NRND:** Not recommended for new designs. Device is in production to support existing customers, but TI does not recommend using this part in a new design.

**PREVIEW:** Device has been announced but is not in production. Samples may or may not be available.

**OBsolete:** TI has discontinued the production of the device.

<sup>(2)</sup> Eco Plan - The planned eco-friendly classification: Pb-Free (RoHS), Pb-Free (RoHS Exempt), or Green (RoHS & no Sb/Br) - please check <http://www.ti.com/productcontent> for the latest availability information and additional product content details.

**TBD:** The Pb-Free/Green conversion plan has not been defined.

**Pb-Free (RoHS):** TI's terms "Lead-Free" or "Pb-Free" mean semiconductor products that are compatible with the current RoHS requirements for all 6 substances, including the requirement that lead not exceed 0.1% by weight in homogeneous materials. Where designed to be soldered at high temperatures, TI Pb-Free products are suitable for use in specified lead-free processes.

**Pb-Free (RoHS Exempt):** This component has a RoHS exemption for either 1) lead-based flip-chip solder bumps used between the die and package, or 2) lead-based die adhesive used between the die and leadframe. The component is otherwise considered Pb-Free (RoHS compatible) as defined above.

**Green (RoHS & no Sb/Br):** TI defines "Green" to mean Pb-Free (RoHS compatible), and free of Bromine (Br) and Antimony (Sb) based flame retardants (Br or Sb do not exceed 0.1% by weight in homogeneous material)

<sup>(3)</sup> MSL, Peak Temp. -- The Moisture Sensitivity Level rating according to the JEDEC industry standard classifications, and peak solder temperature.

**Important Information and Disclaimer:** The information provided on this page represents TI's knowledge and belief as of the date that it is provided. TI bases its knowledge and belief on information provided by third parties, and makes no representation or warranty as to the accuracy of such information. Efforts are underway to better integrate information from third parties. TI has taken and continues to take reasonable steps to provide representative and accurate information but may not have conducted destructive testing or chemical analysis on incoming materials and chemicals. TI and TI suppliers consider certain information to be proprietary, and thus CAS numbers and other limited information may not be available for release.

In no event shall TI's liability arising out of such information exceed the total purchase price of the TI part(s) at issue in this document sold by TI to Customer on an annual basis.

RGF (R-VQFN-N40)

PLASTIC QUAD FLATPACK NO-LEAD

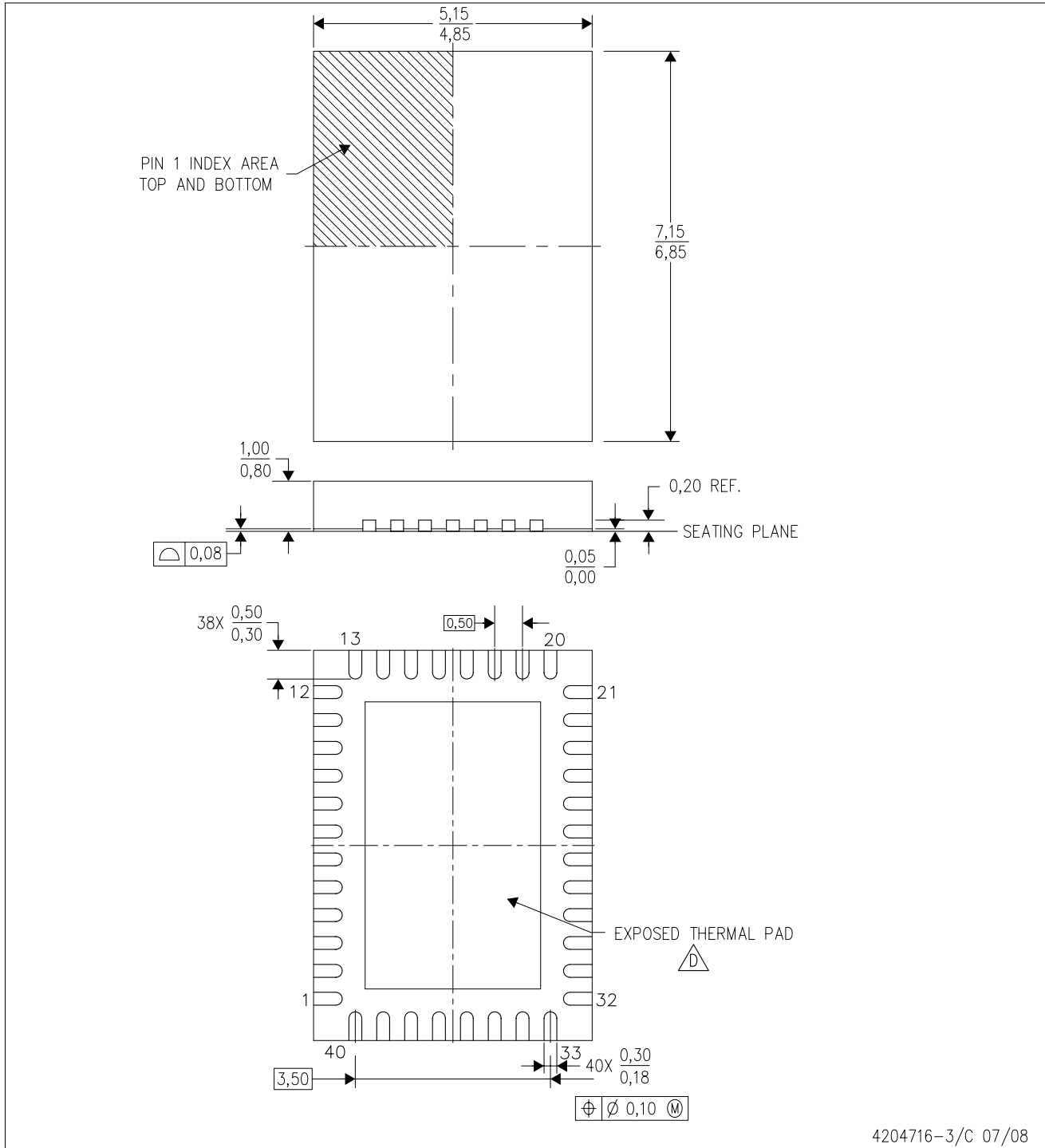

- NOTES:
- A. All linear dimensions are in millimeters. Dimensioning and tolerancing per ASME Y14.5-1994.
  - B. This drawing is subject to change without notice.
  - C. Quad Flatpack, No-leads (QFN) package configuration.
  -  D. The package thermal pad must be soldered to the board for thermal and mechanical performance. See the Product Data Sheet for details regarding the exposed thermal pad dimensions.
  - E. Falls within JEDEC MO-220.

THERMAL INFORMATION

This package incorporates an exposed thermal pad that is designed to be attached directly to an external heatsink. The thermal pad must be soldered directly to the printed circuit board (PCB). After soldering, the PCB can be used as a heatsink. In addition, through the use of thermal vias, the thermal pad can be attached directly to the appropriate copper plane shown in the electrical schematic for the device, or alternatively, can be attached to a special heatsink structure designed into the PCB. This design optimizes the heat transfer from the integrated circuit (IC).

For information on the Quad Flatpack No-Lead (QFN) package and its advantages, refer to Application Report, QFN/SON PCB Attachment, Texas Instruments Literature No. SLUA271. This document is available at [www.ti.com](http://www.ti.com).

The exposed thermal pad dimensions for this package are shown in the following illustration.

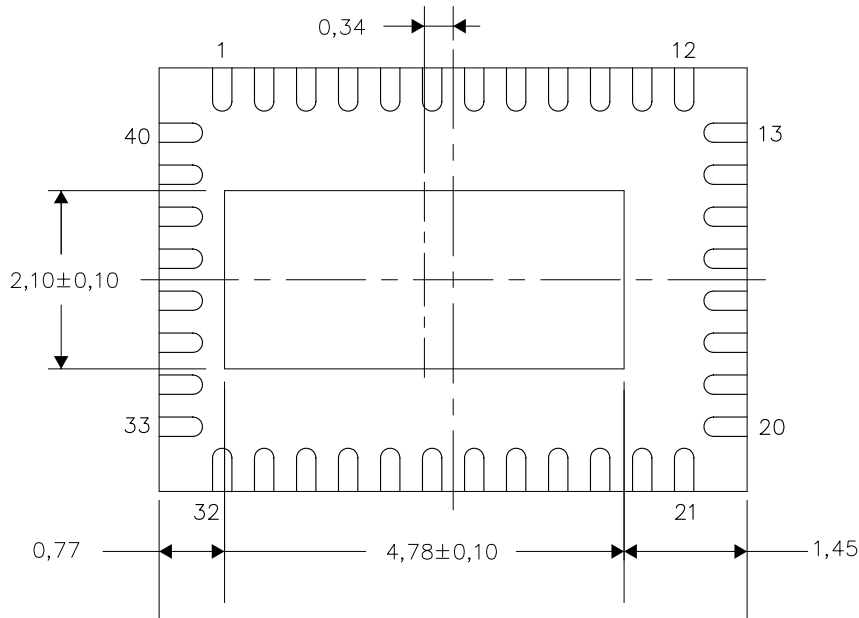

Bottom View

NOTE: All linear dimensions are in millimeters

Exposed Thermal Pad Dimensions

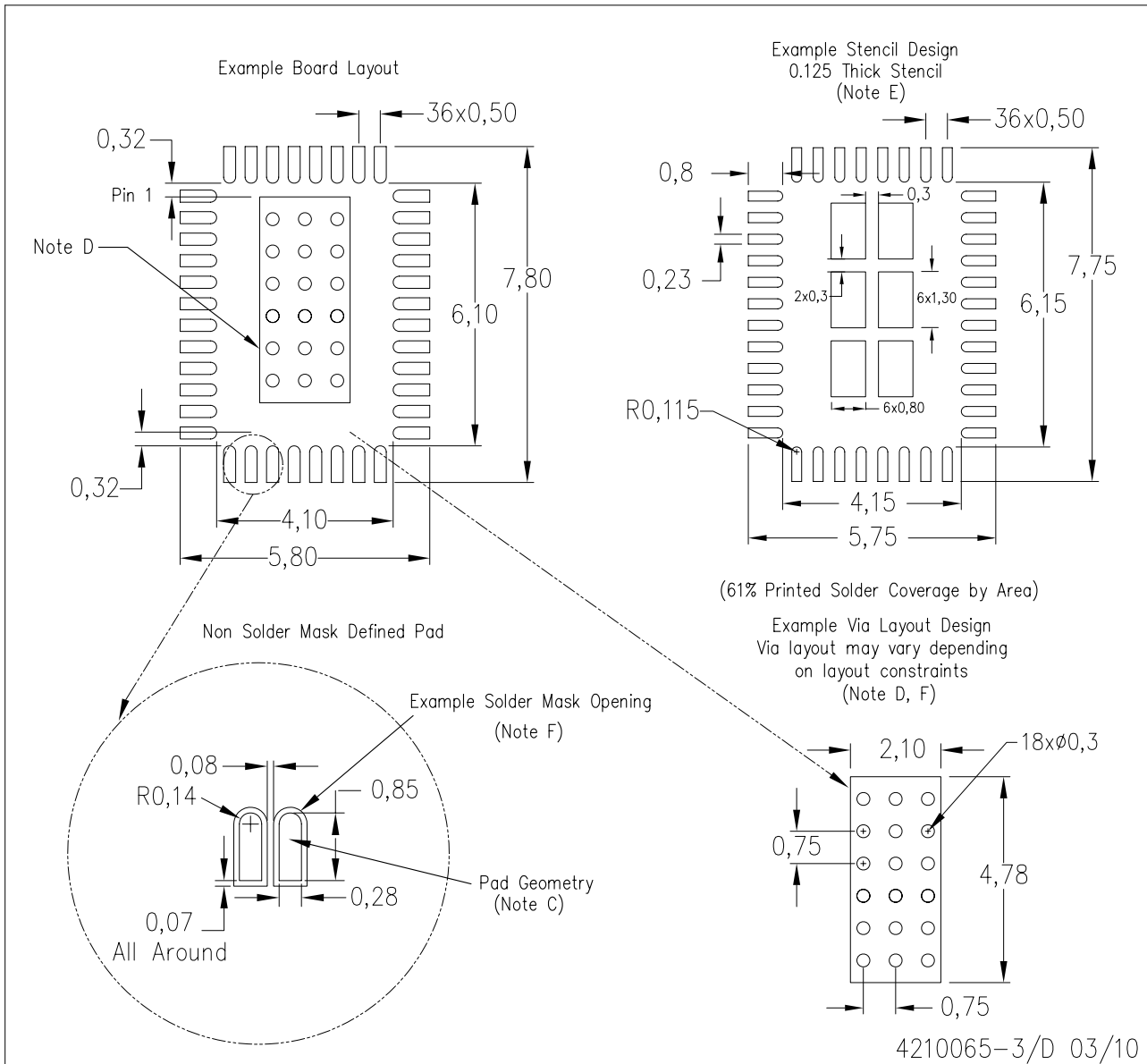

- NOTES:
- All linear dimensions are in millimeters.
  - This drawing is subject to change without notice.
  - Publication IPC-7351 is recommended for alternate designs.
  - This package is designed to be soldered to a thermal pad on the board. Refer to Application Note, QFN/SON PCB Attachment, Texas Instruments Literature No. SLUA271, and also the Product Data Sheets for specific thermal information, via requirements, and recommended board layout. These documents are available at [www.ti.com](http://www.ti.com) <<http://www.ti.com>>.
  - Laser cutting apertures with trapezoidal walls and also rounding corners will offer better paste release. Customers should contact their board assembly site for stencil design recommendations. Refer to IPC 7525 for stencil design considerations.
  - Customers should contact their board fabrication site for recommended solder mask tolerances and via tenting recommendations for vias placed in the thermal pad.

## IMPORTANT NOTICE

Texas Instruments Incorporated and its subsidiaries (TI) reserve the right to make corrections, modifications, enhancements, improvements, and other changes to its products and services at any time and to discontinue any product or service without notice. Customers should obtain the latest relevant information before placing orders and should verify that such information is current and complete. All products are sold subject to TI's terms and conditions of sale supplied at the time of order acknowledgment.

TI warrants performance of its hardware products to the specifications applicable at the time of sale in accordance with TI's standard warranty. Testing and other quality control techniques are used to the extent TI deems necessary to support this warranty. Except where mandated by government requirements, testing of all parameters of each product is not necessarily performed.

TI assumes no liability for applications assistance or customer product design. Customers are responsible for their products and applications using TI components. To minimize the risks associated with customer products and applications, customers should provide adequate design and operating safeguards.

TI does not warrant or represent that any license, either express or implied, is granted under any TI patent right, copyright, mask work right, or other TI intellectual property right relating to any combination, machine, or process in which TI products or services are used. Information published by TI regarding third-party products or services does not constitute a license from TI to use such products or services or a warranty or endorsement thereof. Use of such information may require a license from a third party under the patents or other intellectual property of the third party, or a license from TI under the patents or other intellectual property of TI.

Reproduction of TI information in TI data books or data sheets is permissible only if reproduction is without alteration and is accompanied by all associated warranties, conditions, limitations, and notices. Reproduction of this information with alteration is an unfair and deceptive business practice. TI is not responsible or liable for such altered documentation. Information of third parties may be subject to additional restrictions.

Resale of TI products or services with statements different from or beyond the parameters stated by TI for that product or service voids all express and any implied warranties for the associated TI product or service and is an unfair and deceptive business practice. TI is not responsible or liable for any such statements.

TI products are not authorized for use in safety-critical applications (such as life support) where a failure of the TI product would reasonably be expected to cause severe personal injury or death, unless officers of the parties have executed an agreement specifically governing such use. Buyers represent that they have all necessary expertise in the safety and regulatory ramifications of their applications, and acknowledge and agree that they are solely responsible for all legal, regulatory and safety-related requirements concerning their products and any use of TI products in such safety-critical applications, notwithstanding any applications-related information or support that may be provided by TI. Further, Buyers must fully indemnify TI and its representatives against any damages arising out of the use of TI products in such safety-critical applications.

TI products are neither designed nor intended for use in military/aerospace applications or environments unless the TI products are specifically designated by TI as military-grade or "enhanced plastic." Only products designated by TI as military-grade meet military specifications. Buyers acknowledge and agree that any such use of TI products which TI has not designated as military-grade is solely at the Buyer's risk, and that they are solely responsible for compliance with all legal and regulatory requirements in connection with such use.

TI products are neither designed nor intended for use in automotive applications or environments unless the specific TI products are designated by TI as compliant with ISO/TS 16949 requirements. Buyers acknowledge and agree that, if they use any non-designated products in automotive applications, TI will not be responsible for any failure to meet such requirements.

Following are URLs where you can obtain information on other Texas Instruments products and application solutions:

<b>Products</b>		<b>Applications</b>	
Amplifiers	<a href="http://amplifier.ti.com">amplifier.ti.com</a>	Audio	<a href="http://www.ti.com/audio">www.ti.com/audio</a>
Data Converters	<a href="http://dataconverter.ti.com">dataconverter.ti.com</a>	Automotive	<a href="http://www.ti.com/automotive">www.ti.com/automotive</a>
DLP® Products	<a href="http://www.dlp.com">www.dlp.com</a>	Communications and Telecom	<a href="http://www.ti.com/communications">www.ti.com/communications</a>
DSP	<a href="http://dsp.ti.com">dsp.ti.com</a>	Computers and Peripherals	<a href="http://www.ti.com/computers">www.ti.com/computers</a>
Clocks and Timers	<a href="http://www.ti.com/clocks">www.ti.com/clocks</a>	Consumer Electronics	<a href="http://www.ti.com/consumer-apps">www.ti.com/consumer-apps</a>
Interface	<a href="http://interface.ti.com">interface.ti.com</a>	Energy	<a href="http://www.ti.com/energy">www.ti.com/energy</a>
Logic	<a href="http://logic.ti.com">logic.ti.com</a>	Industrial	<a href="http://www.ti.com/industrial">www.ti.com/industrial</a>
Power Mgmt	<a href="http://power.ti.com">power.ti.com</a>	Medical	<a href="http://www.ti.com/medical">www.ti.com/medical</a>
Microcontrollers	<a href="http://microcontroller.ti.com">microcontroller.ti.com</a>	Security	<a href="http://www.ti.com/security">www.ti.com/security</a>
RFID	<a href="http://www.ti-rfid.com">www.ti-rfid.com</a>	Space, Avionics & Defense	<a href="http://www.ti.com/space-avionics-defense">www.ti.com/space-avionics-defense</a>
RF/IF and ZigBee® Solutions	<a href="http://www.ti.com/lprf">www.ti.com/lprf</a>	Video and Imaging	<a href="http://www.ti.com/video">www.ti.com/video</a>
		Wireless	<a href="http://www.ti.com/wireless-apps">www.ti.com/wireless-apps</a>

Mailing Address: Texas Instruments, Post Office Box 655303, Dallas, Texas 75265  
Copyright © 2010, Texas Instruments Incorporated

[www.BDTIC.com/TI](http://www.BDTIC.com/TI)