



## 1A Low-Dropout Regulator with Reverse Current Protection

### FEATURES

- Stable with 1.0 $\mu$ F or Larger Ceramic Output Capacitor
- Input Voltage Range: 2.2V to 5.5V
- Ultra-Low Dropout Voltage: 130mV typ at 1A
- Excellent Load Transient Response—Even With Only 1.0 $\mu$ F Output Capacitor
- NMOS Topology Delivers Low Reverse Leakage Current
- 1.0% Initial Accuracy
- 3% Overall Accuracy Over Line, Load, and Temperature
- Less Than 20nA typical  $I_Q$  in Shutdown Mode
- Thermal Shutdown and Current Limit for Fault Protection
- Available in Multiple Output Voltage Versions
  - Adjustable Output: 1.20V to 5.5V
  - Custom Outputs Available Using Factory Package-Level Programming

### APPLICATIONS

- Point of Load Regulation for DSPs, FPGAs, ASICs, and Microprocessors
- Post-Regulation for Switching Supplies
- Portable/Battery-Powered Equipment

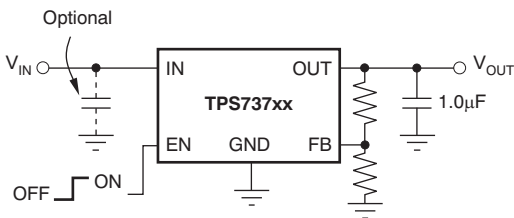

Typical Application Circuit

### DESCRIPTION

The TPS737xx family of linear low-dropout (LDO) voltage regulators uses an NMOS pass element in a voltage-follower configuration. This topology is relatively insensitive to output capacitor value and ESR, allowing a wide variety of load configurations. Load transient response is excellent, even with a small 1.0 $\mu$ F ceramic output capacitor. The NMOS topology also allows very low dropout.

The TPS737xx family uses an advanced BiCMOS process to yield high precision while delivering very low dropout voltages and low ground pin current. Current consumption, when not enabled, is under 20nA and ideal for portable applications. These devices are protected by thermal shutdown and foldback current limit.

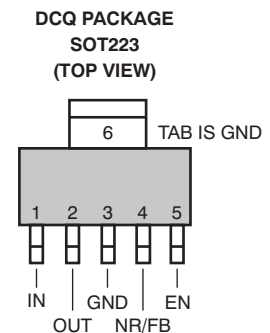
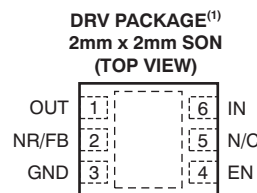
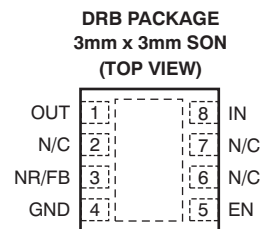

- (1) Power dissipation may limit operating range. Check [Power Dissipation Ratings](#) table.



Please be aware that an important notice concerning availability, standard warranty, and use in critical applications of Texas Instruments semiconductor products and disclaimers thereto appears at the end of this data sheet.

All trademarks are the property of their respective owners.



This integrated circuit can be damaged by ESD. Texas Instruments recommends that all integrated circuits be handled with appropriate precautions. Failure to observe proper handling and installation procedures can cause damage.

ESD damage can range from subtle performance degradation to complete device failure. Precision integrated circuits may be more susceptible to damage because very small parametric changes could cause the device not to meet its published specifications.

### ORDERING INFORMATION<sup>(1)</sup>

PRODUCT	V <sub>OUT</sub> <sup>(2)</sup>
TPS737xx yy yz	<b>XX</b> is nominal output voltage (for example, 25 = 2.5V, 01 = Adjustable <sup>(3)</sup> ). <b>YYY</b> is package designator. <b>Z</b> is package quantity.

- (1) For the most current package and ordering information see the Package Option Addendum at the end of this document, or visit the device product folder at [www.ti.com](http://www.ti.com).
- (2) Most output voltages of 1.25V and 1.3V to 5.0V in 100mV increments are available on a quick-turn basis using innovative factory package-level programming. Minimum order quantities apply; contact factory for details and availability.
- (3) For fixed 1.20V operation, tie FB to OUT.

### ABSOLUTE MAXIMUM RATINGS<sup>(1)</sup>

Over operating free-air temperature range unless otherwise noted.

PARAMETER	TPS737xx	UNIT
V <sub>IN</sub> range	–0.3 to +6.0	V
V <sub>EN</sub> range	–0.3 to +6.0	V
V <sub>OUT</sub> range	–0.3 to +5.5	V
V <sub>NR</sub> , V <sub>FB</sub> range	–0.3 to +6.0	V
Peak output current	Internally limited	
Output short-circuit duration	Indefinite	
Continuous total power dissipation	See <a href="#">Dissipation Ratings Table</a>	
Junction temperature range, T <sub>J</sub>	–55 to +150	°C
Storage temperature range	–65 to +150	°C
ESD rating, HBM	2	kV
ESD rating, CDM	500	V

- (1) Stresses beyond those listed under *Absolute Maximum Ratings* may cause permanent damage to the device. These are stress ratings only, and functional operation of the device at these or any other conditions beyond those indicated under the *Electrical Characteristics* is not implied. Exposure to absolute maximum rated conditions for extended periods may affect device reliability.

### POWER DISSIPATION RATINGS<sup>(1)</sup>

BOARD	PACKAGE	R <sub>θJC</sub>	R <sub>θJA</sub>	DERATING FACTOR ABOVE T <sub>A</sub> = +25°C	T <sub>A</sub> ≤ +25°C POWER RATING	T <sub>A</sub> = +70°C POWER RATING	T <sub>A</sub> = +85°C POWER RATING
Low-K <sup>(2)</sup>	DCQ	15°C/W	53°C/W	18.9mW/°C	1.89W	1.04W	0.76W
High-K <sup>(3)</sup>	DCQ	15°C/W	45°C/W	22.2mW/°C	2.22W	1.22W	0.89W
High-K <sup>(3)</sup>	DRV	20°C/W	65°C/W	15.4mW/°C	1.54W	845mW	615mW
High-K <sup>(3)</sup> <sup>(4)</sup>	DRB	1.2°C/W	40°C/W	25.0mW/°C	2.50W	1.38W	1.0W

- (1) See [Power Dissipation](#) in the [Applications](#) section for more information related to thermal design.
- (2) The JEDEC Low-K (1s) board design used to derive this data was a 3-inch x 3-inch, 2-layer board with 2-ounce copper traces on top of the board.
- (3) The JEDEC High-K (2s2p) board design used to derive this data was a 3-inch x 3-inch, multilayer board with 1-ounce internal power and ground planes and 2-ounce copper traces on the top and bottom of the board.
- (4) Based on preliminary thermal simulations.

## ELECTRICAL CHARACTERISTICS

Over operating temperature range ( $T_J = -40^\circ\text{C}$  to  $+125^\circ\text{C}$ ),  $V_{IN} = V_{OUT(nom)} + 1.0\text{V}^{(1)}$ ,  $I_{OUT} = 10\text{mA}$ ,  $V_{EN} = 2.2\text{V}$ , and  $C_{OUT} = 2.2\mu\text{F}$ , unless otherwise noted. Typical values are at  $T_J = +25^\circ\text{C}$ .

PARAMETER	TEST CONDITIONS	TPS737xx			UNIT	
		MIN	TYP	MAX		
$V_{IN}$	Input voltage range <sup>(1)</sup> , <sup>(2)</sup>	2.2		5.5	V	
$V_{FB}$	Internal reference (TPS73701-DCQ)	$T_J = +25^\circ\text{C}$	1.198	1.2	1.210	V
	Internal reference (TPS73701-DRB)	$T_J = +25^\circ\text{C}$	1.192	1.2	1.216	
$V_{OUT}$	Output voltage range (TPS73701) <sup>(3)</sup>		$V_{FB}$	$5.5 - V_{DO}$	V	
	Accuracy <sup>(1)</sup> , <sup>(4)</sup>	Nominal	$T_J = +25^\circ\text{C}$	-1.0	+1.0	%
			$5.36\text{V} < V_{IN} < 5.5\text{V}$ , $V_{OUT} = 5.08\text{V}$ , $10\text{mA} < I_{OUT} < 800\text{mA}$ , $-40^\circ\text{C} < T_J < +85^\circ\text{C}$ , TPS73701DCQ	-2.0		
	over $V_{IN}$ , $I_{OUT}$ , and T	$V_{OUT} + 0.5\text{V} \leq V_{IN} \leq 5.5\text{V}$ ; $10\text{mA} \leq I_{OUT} \leq 1\text{A}$	-3.0	$\pm 0.5$	+3.0	
$\Delta V_{OUT}\%/\Delta V_{IN}$	Line regulation <sup>(1)</sup>	$V_{OUT(nom)} + 0.5\text{V} \leq V_{IN} \leq 5.5\text{V}$		0.01	%/V	
$\Delta V_{OUT}\%/\Delta I_{OUT}$	Load regulation	$1\text{mA} \leq I_{OUT} \leq 1\text{A}$		0.002	%/mA	
		$10\text{mA} \leq I_{OUT} \leq 1\text{A}$		0.0005		
$V_{DO}$	Dropout voltage <sup>(5)</sup> ( $V_{IN} = V_{OUT(nom)} - 0.1\text{V}$ )	$I_{OUT} = 1\text{A}$		130	500	mV
$Z_O(\text{DO})$	Output impedance in dropout	$2.2\text{V} \leq V_{IN} \leq V_{OUT} + V_{DO}$		0.25		$\Omega$
$I_{CL}$	Output current limit	$V_{OUT} = 0.9 \times V_{OUT(nom)}$	1.05	1.6	2.2	A
$I_{SC}$	Short-circuit current	$V_{OUT} = 0\text{V}$		450		mA
$I_{REV}$	Reverse leakage current <sup>(6)</sup> ( $-I_{IN}$ )	$V_{EN} \leq 0.5\text{V}$ , $0\text{V} \leq V_{IN} \leq V_{OUT}$		0.1		$\mu\text{A}$
$I_{GND}$	GND pin current	$I_{OUT} = 10\text{mA}$ ( $I_Q$ )		400		$\mu\text{A}$
		$I_{OUT} = 1\text{A}$		1300		
$I_{SHDN}$	Shutdown current ( $I_{GND}$ )	$V_{EN} \leq 0.5\text{V}$ , $V_{OUT} \leq V_{IN} \leq 5.5$		20		nA
$I_{FB}$	FB pin current (TPS73701)			0.1	0.6	$\mu\text{A}$
PSRR	Power-supply rejection ratio (ripple rejection)	$f = 100\text{Hz}$ , $I_{OUT} = 1\text{A}$		58		dB
		$f = 10\text{kHz}$ , $I_{OUT} = 1\text{A}$		37		
$V_N$	Output noise voltage BW = 10Hz to 100kHz	$C_{OUT} = 10\mu\text{F}$		$27 \times V_{OUT}$		$\mu\text{V}_{RMS}$
$t_{STR}$	Startup time	$V_{OUT} = 3\text{V}$ , $R_L = 30\Omega$ , $C_{OUT} = 1\mu\text{F}$		600		$\mu\text{s}$
$V_{EN(\text{HI})}$	EN pin high (enabled)		1.7		$V_{IN}$	V
$V_{EN(\text{LO})}$	EN pin low (shutdown)		0		0.5	V
$I_{EN(\text{HI})}$	EN pin current (enabled)	$V_{EN} = 5.5\text{V}$		20		nA
$T_{SD}$	Thermal shutdown temperature	Shutdown, temperature increasing		+160		$^\circ\text{C}$
		Reset, temperature decreasing		+140		
$T_J$	Operating junction temperature		-40		+125	$^\circ\text{C}$

(1) Minimum  $V_{IN} = V_{OUT} + V_{DO}$  or 2.2V, whichever is greater.

(2) For  $V_{OUT(nom)} < 1.6\text{V}$ , when  $V_{IN} \leq 1.6\text{V}$ , the output will lock to  $V_{IN}$  and may result in an over-voltage condition on the output. To avoid this situation, disable the device before powering down  $V_{IN}$ .

(3) TPS73701 is tested at  $V_{OUT} = 1.2\text{V}$ .

(4) Tolerance of external resistors not included in this specification.

(5)  $V_{DO}$  is not measured for fixed output versions with  $V_{OUT(nom)} < 2.3\text{V}$  since minimum  $V_{IN} = 2.2\text{V}$ .

(6) Fixed-voltage versions only; refer to the [Applications](#) section for more information.

FUNCTIONAL BLOCK DIAGRAMS

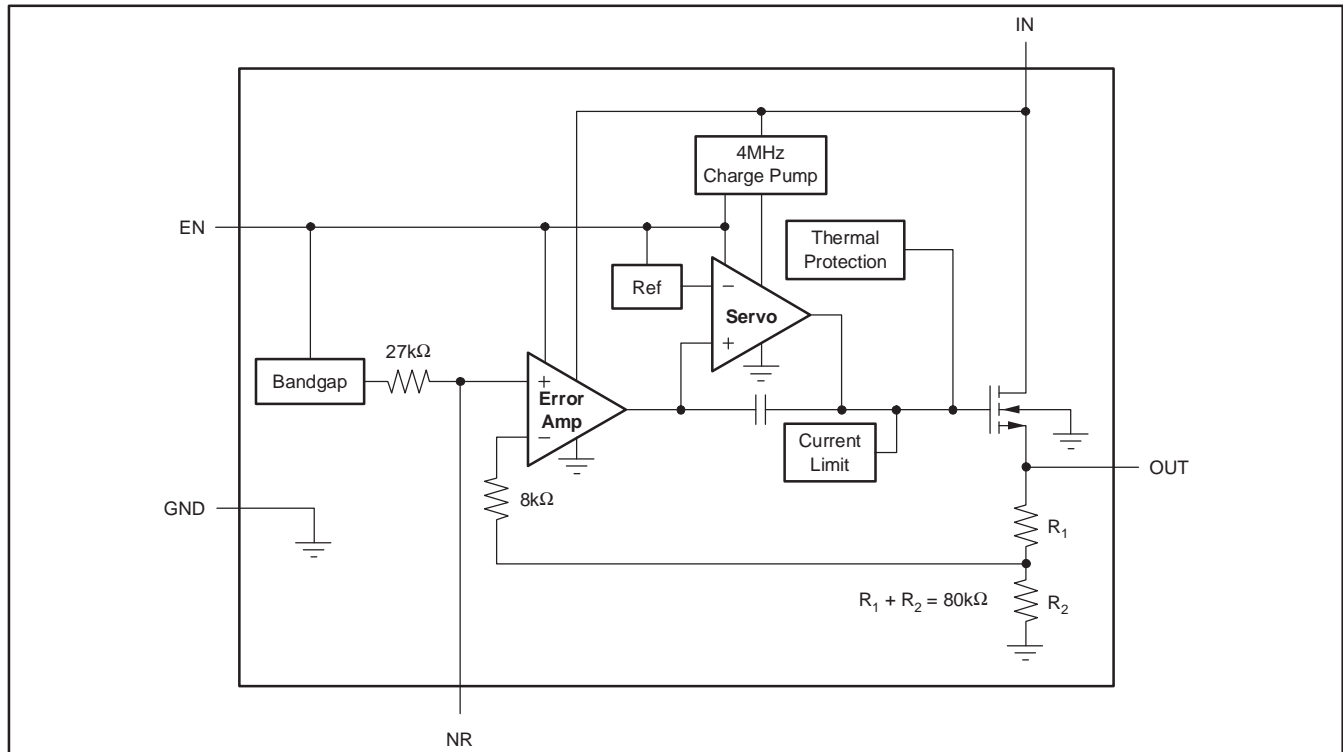

Figure 1. Fixed Voltage Version

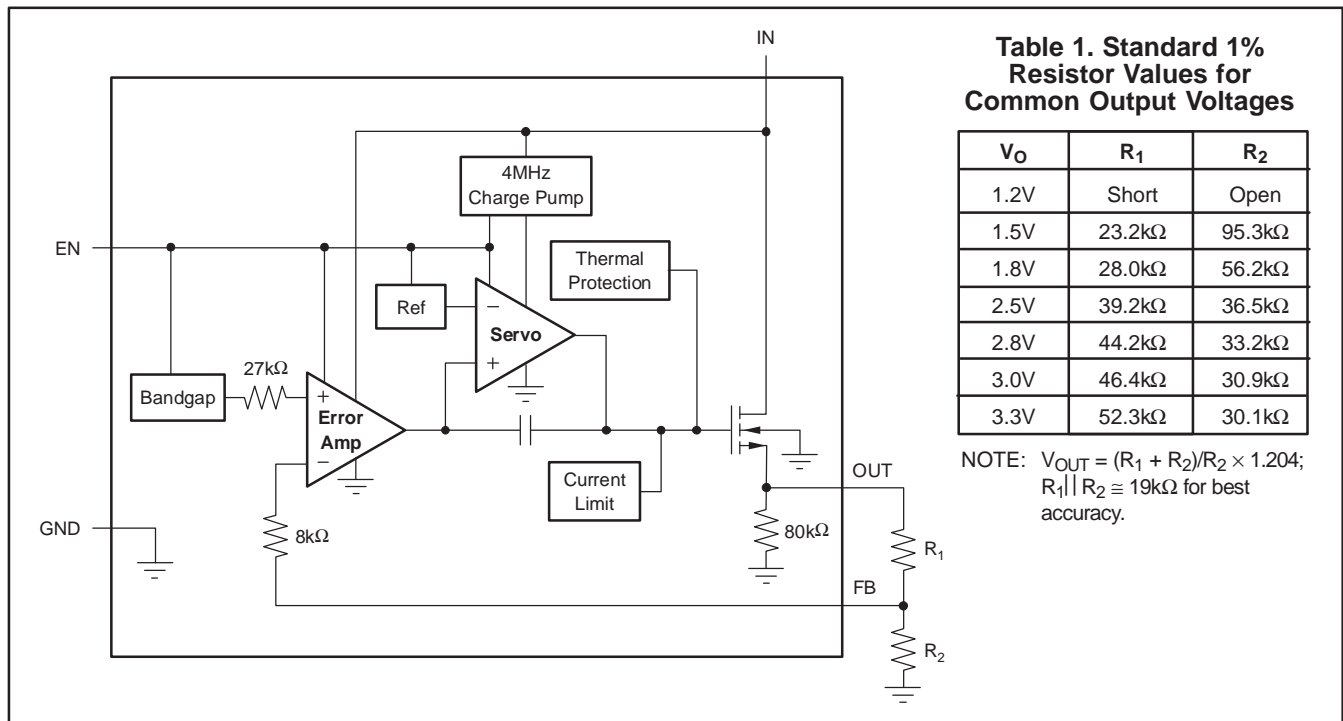

Table 1. Standard 1% Resistor Values for Common Output Voltages

V <sub>O</sub>	R <sub>1</sub>	R <sub>2</sub>
1.2V	Short	Open
1.5V	23.2kΩ	95.3kΩ
1.8V	28.0kΩ	56.2kΩ
2.5V	39.2kΩ	36.5kΩ
2.8V	44.2kΩ	33.2kΩ
3.0V	46.4kΩ	30.9kΩ
3.3V	52.3kΩ	30.1kΩ

NOTE:  $V_{OUT} = (R_1 + R_2)/R_2 \times 1.204$ ;  
 $R_1 || R_2 \cong 19k\Omega$  for best accuracy.

Figure 2. Adjustable Voltage Version

## PIN CONFIGURATIONS

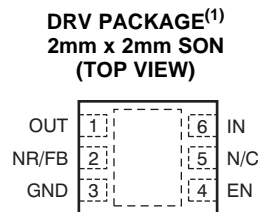
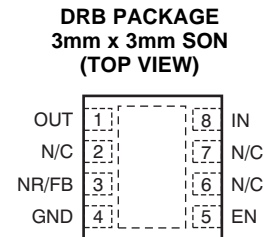
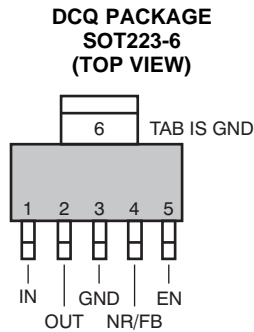

(1) Power dissipation may limit operating range. Check [Power Dissipation Ratings](#) table.

**Table 1. Pin Descriptions**

PIN NAME	SOT223 (DCQ) PIN NO.	3x3 SON (DRB) PIN NO.	2x2 SON (DRV) PIN NO.	DESCRIPTION
IN	1	8	6	Unregulated input supply
GND	3, 6	4, Pad	3, Pad	Ground
EN	5	5	4	Driving the enable pin (EN) high turns on the regulator. Driving this pin low puts the regulator into shutdown mode. Refer to the <a href="#">Shutdown</a> section under <a href="#">Applications Information</a> for more details. EN must not be left floating and can be connected to IN if not used.
NR	4	3	2	Fixed voltage versions only—connecting an external capacitor to this pin bypasses noise generated by the internal bandgap, reducing output noise to very low levels.
FB	4	3	2	Adjustable voltage version only—this is the input to the control loop error amplifier, and is used to set the output voltage of the device.
OUT	2	1	1	Regulator output. A 1.0 $\mu$ F or larger capacitor of any type is required for stability.
NC	—	2, 6, 7	5	Not connected

### TYPICAL CHARACTERISTICS

For all voltage versions at  $T_J = +25^\circ\text{C}$ ,  $V_{IN} = V_{OUT(nom)} + 1.0\text{V}$ ,  $I_{OUT} = 10\text{mA}$ ,  $V_{EN} = 2.2\text{V}$ , and  $C_{OUT} = 2.2\mu\text{F}$ , unless otherwise noted.

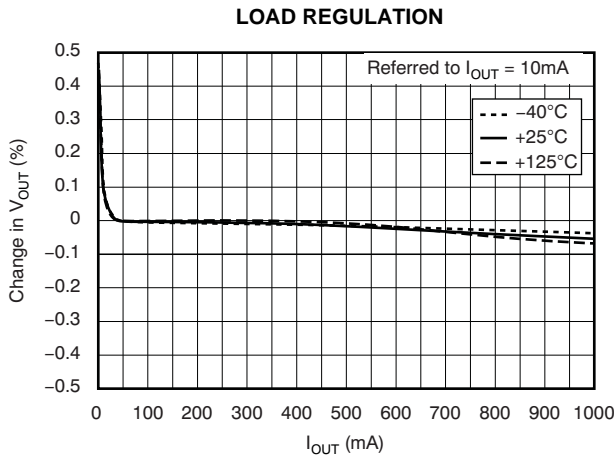

Figure 3.

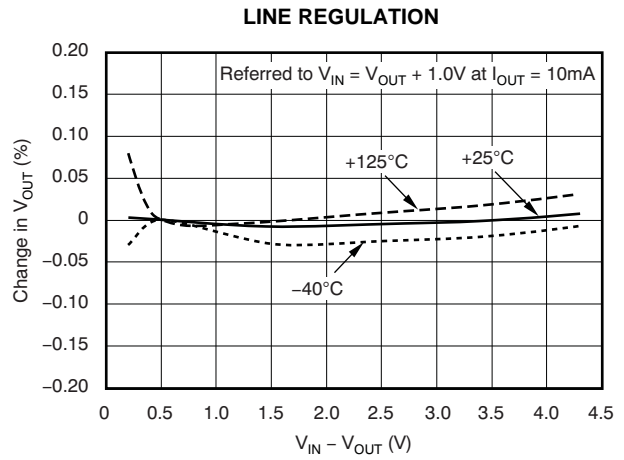

Figure 4.

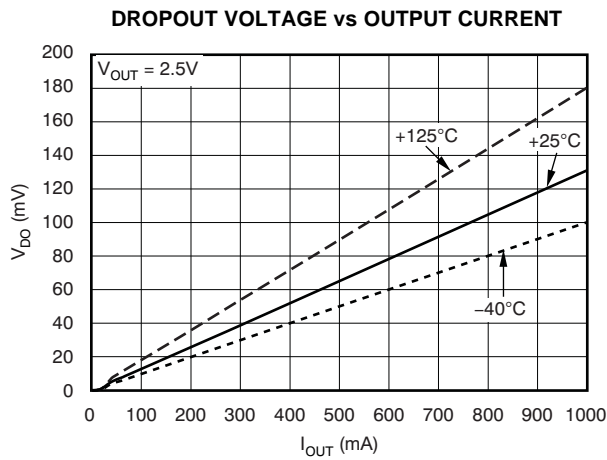

Figure 5.

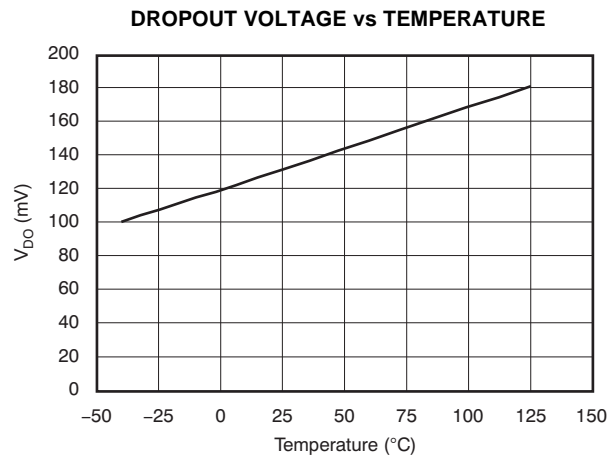

Figure 6.

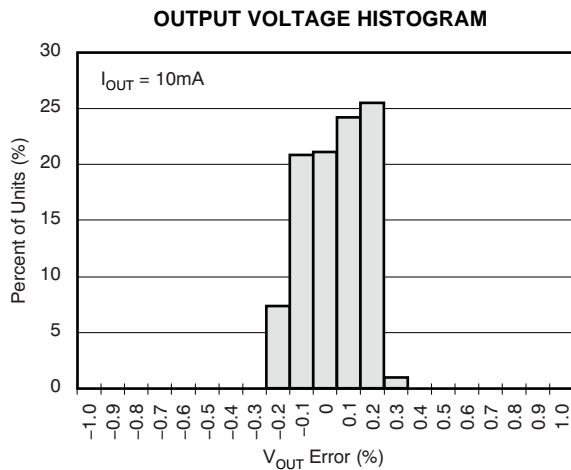

Figure 7.

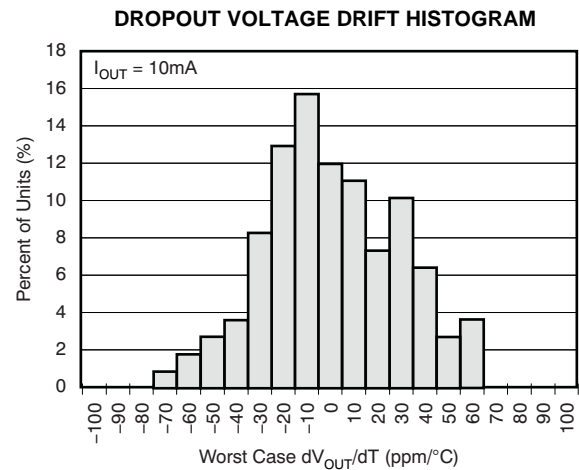

Figure 8.

**TYPICAL CHARACTERISTICS (continued)**

For all voltage versions at  $T_J = +25^\circ\text{C}$ ,  $V_{IN} = V_{OUT(nom)} + 1.0\text{V}$ ,  $I_{OUT} = 10\text{mA}$ ,  $V_{EN} = 2.2\text{V}$ , and  $C_{OUT} = 2.2\mu\text{F}$ , unless otherwise noted.

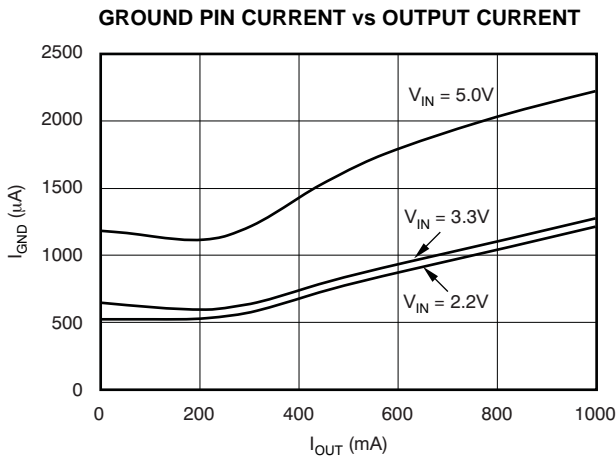

Figure 9.

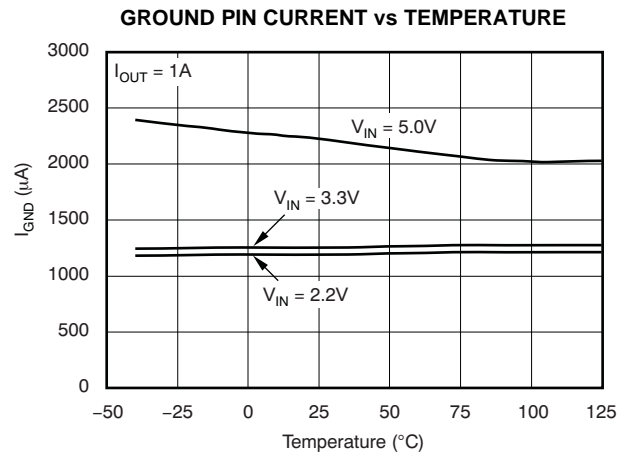

Figure 10.

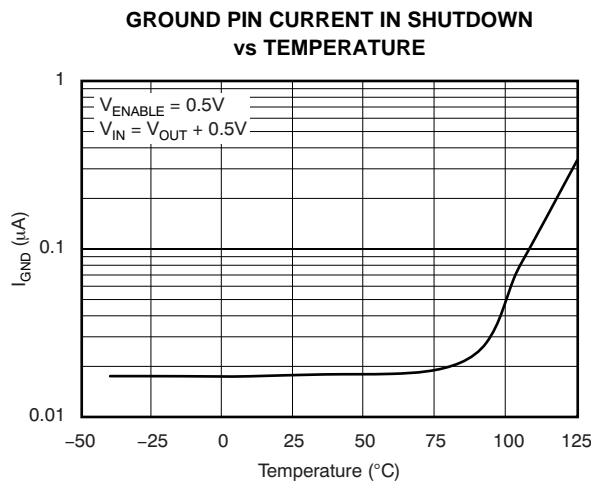

Figure 11.

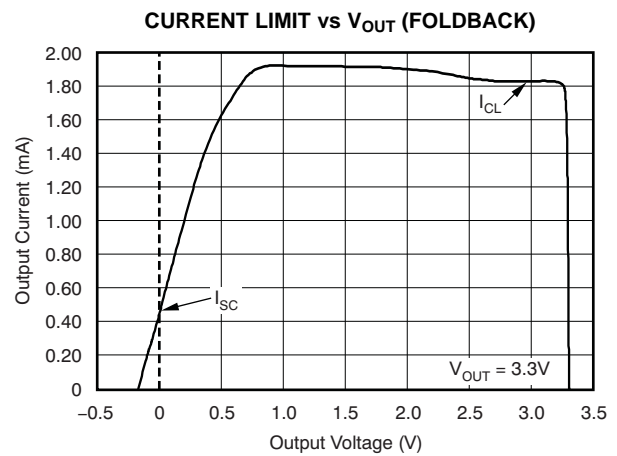

Figure 12.

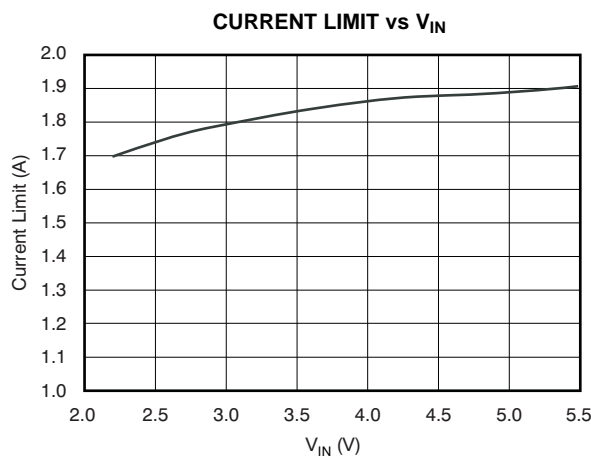

Figure 13.

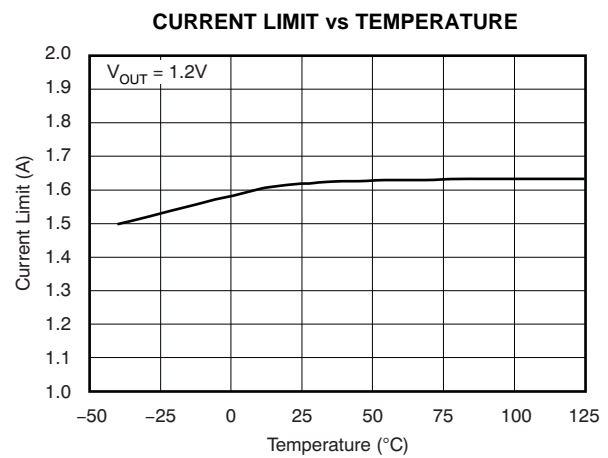
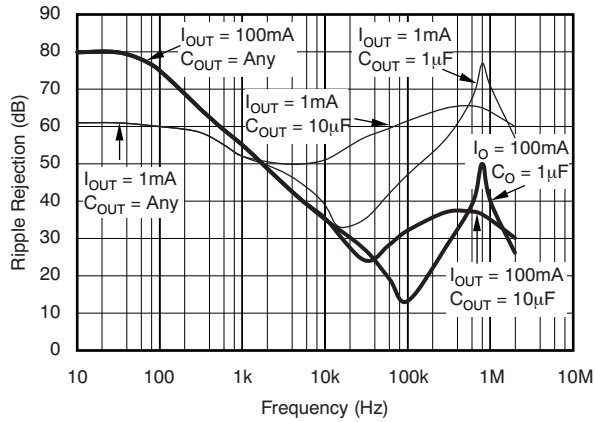

Figure 14.

**TYPICAL CHARACTERISTICS (continued)**

For all voltage versions at  $T_J = +25^\circ\text{C}$ ,  $V_{IN} = V_{OUT(nom)} + 1.0\text{V}$ ,  $I_{OUT} = 10\text{mA}$ ,  $V_{EN} = 2.2\text{V}$ , and  $C_{OUT} = 2.2\mu\text{F}$ , unless otherwise noted.

**PSRR (RIPPLE REJECTION) vs FREQUENCY**



**Figure 15.**

**PSRR (RIPPLE REJECTION) vs  $V_{IN} - V_{OUT}$**

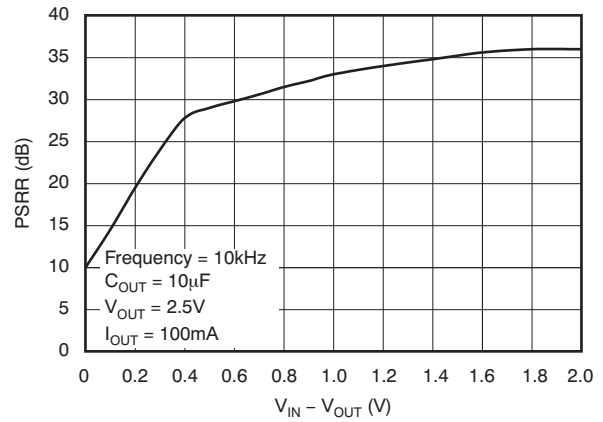

**Figure 16.**

**NOISE SPECTRAL DENSITY**

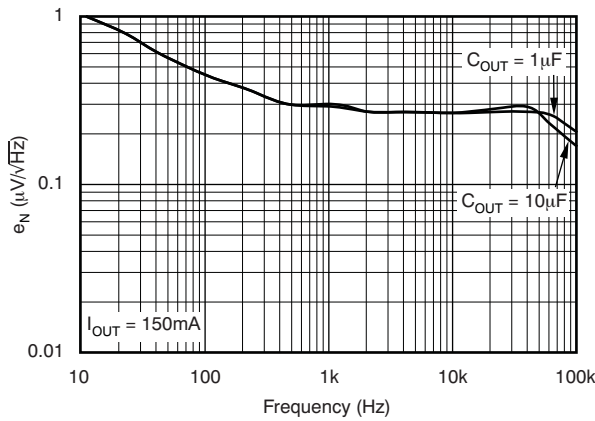

**Figure 17.**

**TPS73701**

**RMS NOISE VOLTAGE vs  $C_{FB}$**

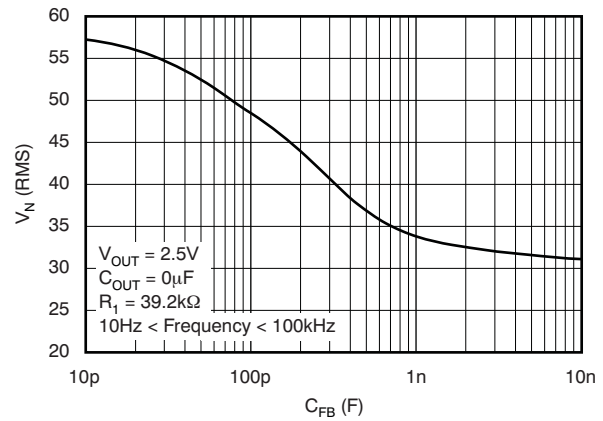

**Figure 18.**

**RMS NOISE VOLTAGE vs  $C_{OUT}$**

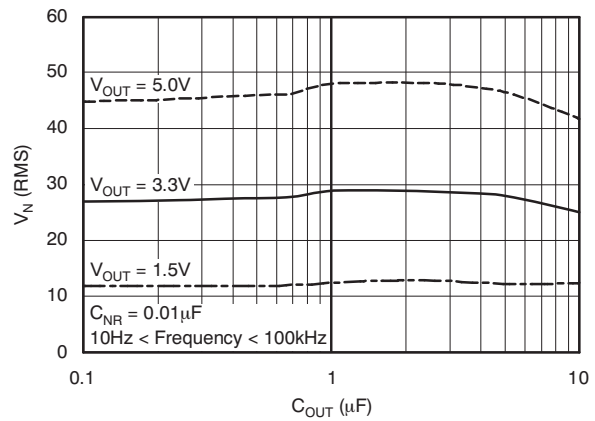

**Figure 19.**

**RMS NOISE VOLTAGE vs  $C_{NR}$**

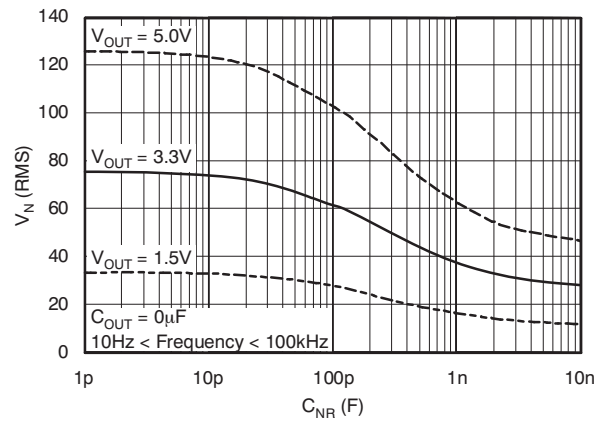

**Figure 20.**



**TYPICAL CHARACTERISTICS (continued)**

For all voltage versions at  $T_J = +25^\circ\text{C}$ ,  $V_{IN} = V_{OUT(nom)} + 1.0\text{V}$ ,  $I_{OUT} = 10\text{mA}$ ,  $V_{EN} = 2.2\text{V}$ , and  $C_{OUT} = 2.2\mu\text{F}$ , unless otherwise noted.

**TPS73733  
LOAD TRANSIENT RESPONSE**

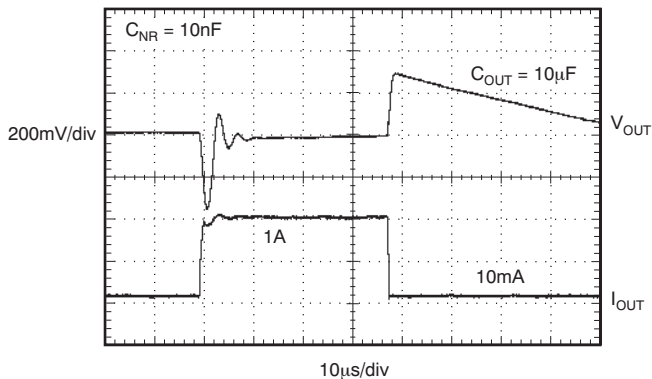

Figure 21.

**TPS73733  
LINE TRANSIENT RESPONSE**

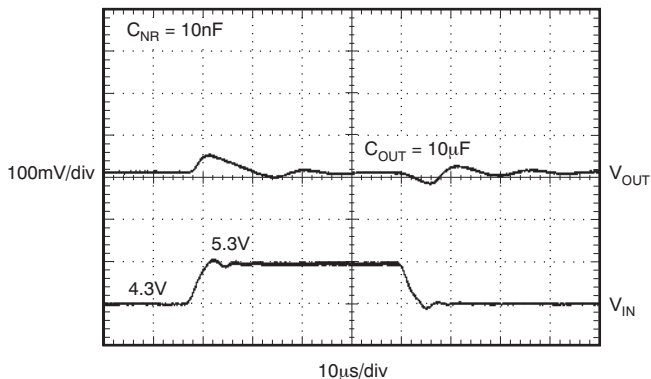

Figure 22.

**TPS73701  
TURN-ON RESPONSE**

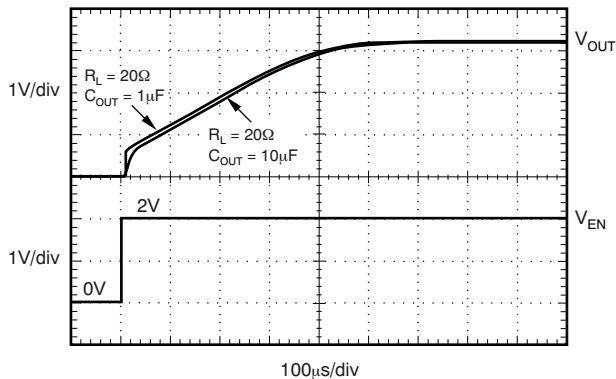

Figure 23.

**TPS73701  
TURN-OFF RESPONSE**

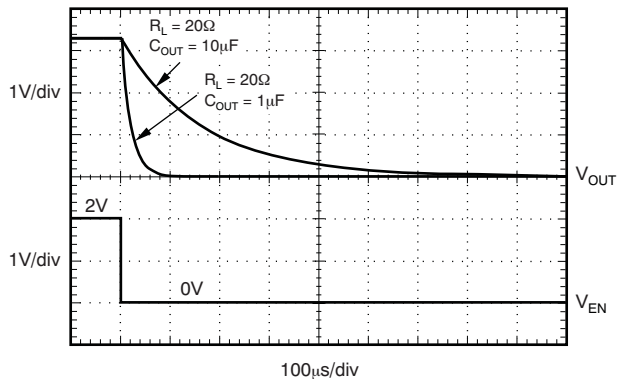

Figure 24.

**TPS73701, V\_OUT = 3.3V  
POWER-UP/POWER-DOWN**

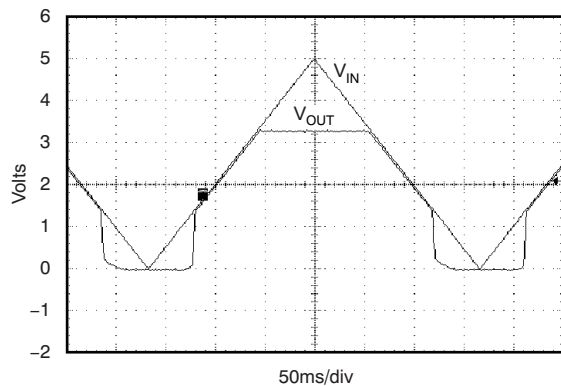

Figure 25.

**I\_ENABLE VS TEMPERATURE**

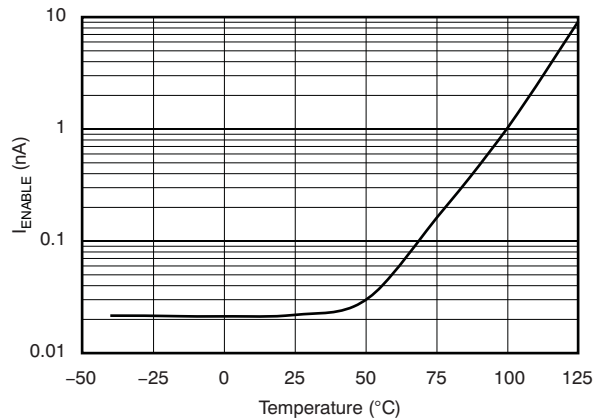

Figure 26.

**TYPICAL CHARACTERISTICS (continued)**

For all voltage versions at  $T_J = +25^\circ\text{C}$ ,  $V_{IN} = V_{OUT(nom)} + 1.0\text{V}$ ,  $I_{OUT} = 10\text{mA}$ ,  $V_{EN} = 2.2\text{V}$ , and  $C_{OUT} = 2.2\mu\text{F}$ , unless otherwise noted.

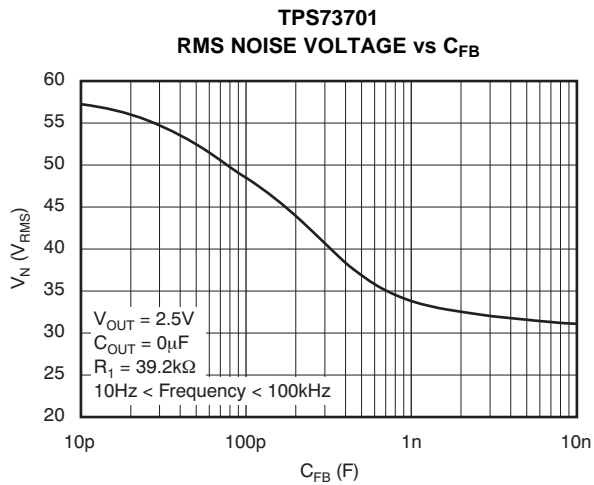

Figure 27.

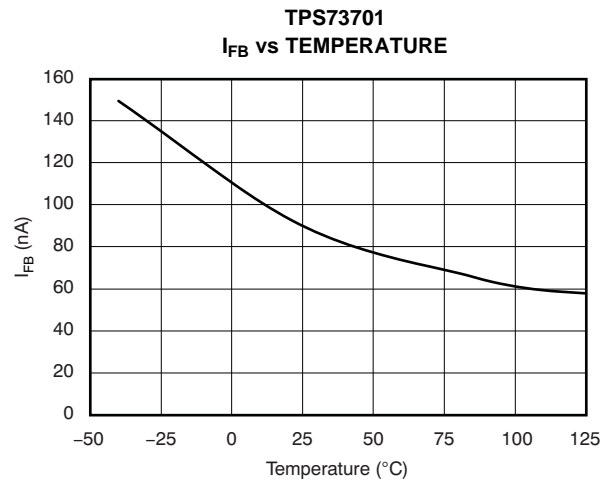

Figure 28.

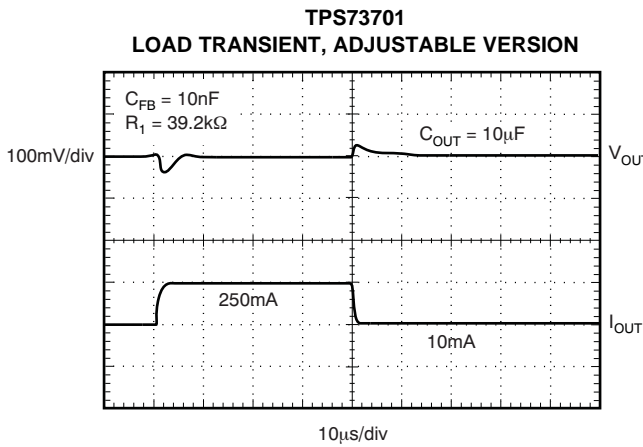

Figure 29.

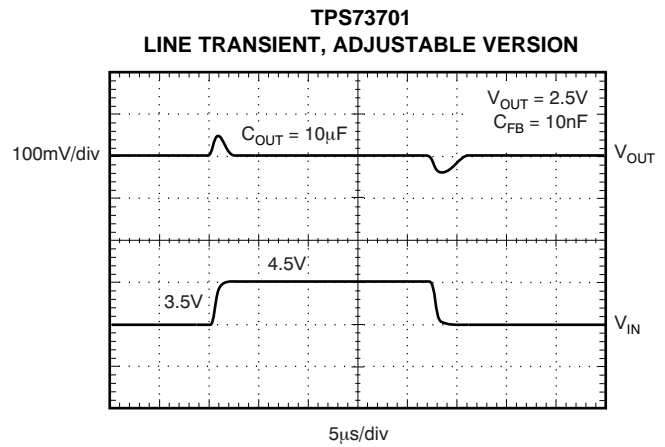
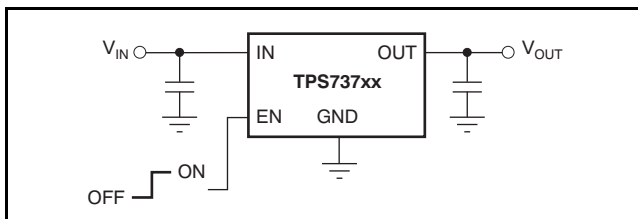

Figure 30.

## APPLICATION INFORMATION

The TPS737xx belongs to a family of new generation LDO regulators that use an NMOS pass transistor to achieve ultra-low-dropout performance, reverse current blockage, and freedom from output capacitor constraints. These features combined with an enable input make the TPS737xx ideal for portable applications. This regulator family offers a wide selection of fixed output voltage versions and an adjustable output version. All versions have thermal and over-current protection, including foldback current limit.

Figure 31 shows the basic circuit connections for the fixed voltage models. Figure 32 gives the connections for the adjustable output version (TPS73701).



**Figure 31. Typical Application Circuit for Fixed-Voltage Versions**

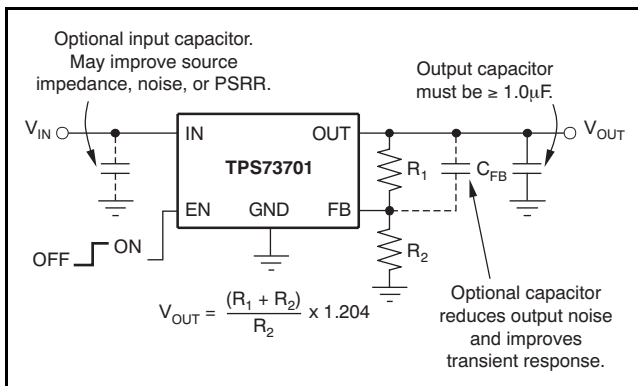

**Figure 32. Typical Application Circuit for Adjustable-Voltage Version**

$R_1$  and  $R_2$  can be calculated for any output voltage using the formula shown in Figure 32. Sample resistor values for common output voltages are shown in Figure 2.

For best accuracy, make the parallel combination of  $R_1$  and  $R_2$  approximately equal to 19k $\Omega$ . This 19k $\Omega$ ,

in addition to the internal 8k $\Omega$  resistor, presents the same impedance to the error amp as the 27k $\Omega$  bandgap reference output. This impedance helps compensate for leakages into the error amp terminals.

### INPUT AND OUTPUT CAPACITOR REQUIREMENTS

Although an input capacitor is not required for stability if input impedance is very low, it is good analog design practice to connect a 0.1 $\mu$ F to 1 $\mu$ F low equivalent series resistance (ESR) capacitor across the input supply near the regulator. This capacitor counteracts reactive input sources and improves transient response, noise rejection, and ripple rejection. A higher-value capacitor may be necessary if large, fast rise-time load transients are anticipated or the device is located several inches from the power source.

The TPS737xx requires a 1.0 $\mu$ F output capacitor for stability. It is designed to be stable for all available types and values of capacitors. In applications where multiple low ESR capacitors are in parallel, ringing may occur when the product of  $C_{OUT}$  and total ESR drops below 50n $\Omega$ F. Total ESR includes all parasitic resistances, including capacitor ESR and board, socket, and solder joint resistance. In most applications, the sum of capacitor ESR and trace resistance will meet this requirement.

### OUTPUT NOISE

A precision bandgap reference is used to generate the internal reference voltage,  $V_{REF}$ . This reference is the dominant noise source within the TPS737xx and it generates approximately 32 $\mu$ V<sub>RMS</sub> (10Hz to 100kHz) at the reference output (NR). The regulator control loop gains up the reference noise with the same gain as the reference voltage, so that the noise voltage of the regulator is approximately given by:

$$V_N = 32\mu V_{RMS} \times \frac{(R_1 + R_2)}{R_2} = 32\mu V_{RMS} \times \frac{V_{OUT}}{V_{REF}} \quad (1)$$

Since the value of  $V_{REF}$  is 1.2V, this relationship reduces to:

$$V_N(\mu V_{RMS}) = 27 \left( \frac{\mu V_{RMS}}{V} \right) \times V_{OUT} (V) \quad (2)$$

for the case of no  $C_{NR}$ .

An internal 27k $\Omega$  resistor in series with the noise reduction pin (NR) forms a low-pass filter for the voltage reference when an external noise reduction capacitor,  $C_{NR}$ , is connected from NR to ground. For  $C_{NR} = 10\text{nF}$ , the total noise in the 10Hz to 100kHz bandwidth is reduced by a factor of  $\sim 3.2$ , giving the approximate relationship:

$$V_N(\mu\text{V}_{\text{RMS}}) = 8.5 \left( \frac{\mu\text{V}_{\text{RMS}}}{\text{V}} \right) \times V_{\text{OUT}}(\text{V}) \quad (3)$$

for  $C_{NR} = 10\text{nF}$ .

This noise reduction effect is shown as RMS Noise Voltage vs  $C_{NR}$  in the [Typical Characteristics](#) section.

The TPS73701 adjustable version does not have the NR pin available. However, connecting a feedback capacitor,  $C_{FB}$ , from the output to the feedback pin (FB) reduces output noise and improve load transient performance. This capacitor should be limited to 0.1 $\mu\text{F}$ .

The TPS737xx uses an internal charge pump to develop an internal supply voltage sufficient to drive the gate of the NMOS pass element above  $V_{\text{OUT}}$ . The charge pump generates  $\sim 250\mu\text{V}$  of switching noise at  $\sim 4\text{MHz}$ ; however, charge-pump noise contribution is negligible at the output of the regulator for most values of  $I_{\text{OUT}}$  and  $C_{\text{OUT}}$ .

### BOARD LAYOUT RECOMMENDATION TO IMPROVE PSRR AND NOISE PERFORMANCE

To improve ac performance such as PSRR, output noise, and transient response, it is recommended that the printed circuit board (PCB) be designed with separate ground planes for  $V_{\text{IN}}$  and  $V_{\text{OUT}}$ , with each ground plane connected only at the GND pin of the device. In addition, the ground connection for the bypass capacitor should connect directly to the GND pin of the device.

### INTERNAL CURRENT LIMIT

The TPS737xx internal current limit helps protect the regulator during fault conditions. Foldback current limit helps to protect the regulator from damage during output short-circuit conditions by reducing current limit when  $V_{\text{OUT}}$  drops below 0.5V. See [Figure 12](#) in the [Typical Characteristics](#) section.

Note from [Figure 12](#) that approximately  $-0.2\text{V}$  of  $V_{\text{OUT}}$  results in a current limit of 0mA. Therefore, if OUT is forced below  $-0.2\text{V}$  before EN goes high, the device may not start up. In applications that work with both a positive and negative voltage supply, the TPS737xx should be enabled first.

### ENABLE PIN AND SHUTDOWN

The enable pin (EN) is active high and is compatible with standard TTL-CMOS levels. A  $V_{\text{EN}}$  below 0.5V (max) turns the regulator off and drops the GND pin current to approximately 10nA. When EN is used to shutdown the regulator, all charge is removed from the pass transistor gate, and the output ramps back up to a regulated  $V_{\text{OUT}}$  (see [Figure 23](#)).

When shutdown capability is not required, EN can be connected to  $V_{\text{IN}}$ . However, the pass gate may not be discharged using this configuration, and the pass transistor may be left on (enhanced) for a significant time after  $V_{\text{IN}}$  has been removed. This scenario can result in reverse current flow (if the IN pin is low impedance) and faster ramp times upon power-up. In addition, for  $V_{\text{IN}}$  ramp times slower than a few milliseconds, the output may overshoot upon power-up.

Note that current limit foldback can prevent device start-up under some conditions. See the [Internal Current Limit](#) section for more information.

### DROPOUT VOLTAGE

The TPS737xx uses an NMOS pass transistor to achieve extremely low dropout. When  $(V_{\text{IN}} - V_{\text{OUT}})$  is less than the dropout voltage ( $V_{\text{DO}}$ ), the NMOS pass device is in its linear region of operation and the input-to-output resistance is the  $R_{\text{DS, ON}}$  of the NMOS pass element.

For large step changes in load current, the TPS737xx requires a larger voltage drop from  $V_{\text{IN}}$  to  $V_{\text{OUT}}$  to avoid degraded transient response. The boundary of this transient dropout region is approximately twice the dc dropout. Values of  $V_{\text{IN}} - V_{\text{OUT}}$  above this line ensure normal transient response.

Operating in the transient dropout region can cause an increase in recovery time. The time required to recover from a load transient is a function of the magnitude of the change in load current rate, the rate of change in load current, and the available headroom ( $V_{\text{IN}}$  to  $V_{\text{OUT}}$  voltage drop). Under worst-case conditions [full-scale instantaneous load change with  $(V_{\text{IN}} - V_{\text{OUT}})$  close to dc dropout levels], the TPS737xx can take a couple of hundred microseconds to return to the specified regulation accuracy.

## TRANSIENT RESPONSE

The low open-loop output impedance provided by the NMOS pass element in a voltage follower configuration allows operation without a 1.0µF output capacitor. As with any regulator, the addition of additional capacitance from the OUT pin to ground reduces undershoot magnitude but increases its duration. In the adjustable version, the addition of a capacitor,  $C_{FB}$ , from the OUT pin to the FB pin will also improve the transient response.

The TPS737xx does not have active pull-down when the output is over-voltage. This architecture allows applications that connect higher voltage sources, such as alternate power supplies, to the output. This architecture also results in an output overshoot of several percent if the load current quickly drops to zero when a capacitor is connected to the output. The duration of overshoot can be reduced by adding a load resistor. The overshoot decays at a rate determined by output capacitor  $C_{OUT}$  and the internal/external load resistance. The rate of decay is given by:

(Fixed voltage version)

$$\frac{dV}{dT} = \frac{V_{OUT}}{C_{OUT} \times 80k\Omega \parallel R_{LOAD}} \quad (4)$$

(Adjustable voltage version)

$$\frac{dV}{dT} = \frac{V_{OUT}}{C_{OUT} \times 80k\Omega \parallel (R_1 + R_2) \parallel R_{LOAD}} \quad (5)$$

## REVERSE CURRENT

The NMOS pass element of the TPS737xx provides inherent protection against current flow from the output of the regulator to the input when the gate of the pass device is pulled low. To ensure that all charge is removed from the gate of the pass element, the EN pin must be driven low before the input voltage is removed. If this is not done, the pass element may be left on because of stored charge on the gate.

After the EN pin is driven low, no bias voltage is needed on any pin for reverse current blocking. Note that reverse current is specified as the current flowing out of the IN pin because of voltage applied on the OUT pin. There will be additional current flowing into the OUT pin as a result of the 80kΩ internal resistor divider to ground (see [Figure 1](#) and [Figure 2](#)).

For the TPS73701, reverse current may flow when  $V_{FB}$  is more than 1.0V above  $V_{IN}$ .

## THERMAL PROTECTION

Thermal protection disables the output when the junction temperature rises to approximately +160°C, allowing the device to cool. When the junction temperature cools to approximately +140°C, the output circuitry is again enabled. Depending on power dissipation, thermal resistance, and ambient temperature, the thermal protection circuit may cycle on and off. This cycling limits the dissipation of the regulator, protecting it from damage due to overheating.

Any tendency to activate the thermal protection circuit indicates excessive power dissipation or an inadequate heatsink. For reliable operation, junction temperature should be limited to +125°C maximum. To estimate the margin of safety in a complete design (including heatsink), increase the ambient temperature until the thermal protection is triggered; use worst-case loads and signal conditions. For good reliability, thermal protection should trigger at least +35°C above the maximum expected ambient condition of your application. This produces a worst-case junction temperature of +125°C at the highest expected ambient temperature and worst-case load.

The internal protection circuitry of the TPS737xx has been designed to protect against overload conditions. It was not intended to replace proper heatsinking. Continuously running the TPS737xx into thermal shutdown degrades device reliability.

## POWER DISSIPATION

The ability to remove heat from the die is different for each package type, presenting different considerations in the PCB layout. The PCB area around the device that is free of other components moves the heat from the device to the ambient air. Performance data for JEDEC low- and high-K boards are shown in the [Power Dissipation Ratings](#) table. Using heavier copper will increase the effectiveness in removing heat from the device. The addition of plated through-holes to heat-dissipating layers also improves the heatsink effectiveness.

Power dissipation depends on input voltage and load conditions. Power dissipation ( $P_D$ ) is equal to the product of the output current times the voltage drop across the output pass element ( $V_{IN}$  to  $V_{OUT}$ ):

$$P_D = (V_{IN} - V_{OUT}) \times I_{OUT} \quad (6)$$

Power dissipation can be minimized by using the lowest possible input voltage necessary to assure the required output voltage.

## PACKAGE MOUNTING

Solder pad footprint recommendations for the TPS737xx are presented in Application Bulletin *Solder Pad Recommendations for Surface-Mount Devices* ([SBFA015](#)), available from the Texas Instruments web site at [www.ti.com](#).

---

## REVISION HISTORY

NOTE: Page numbers for previous revisions may differ from page numbers in the current version.

Changes from Revision J (August, 2009) to Revision K	Page
• Added DRV package option and footnote (1) to front-page drawing .....	1
• Updated <a href="#">Power Dissipation Ratings</a> table to reflect DRV package option .....	2
• Added DRV package pinout drawing and pin information to <a href="#">Pin Configurations</a> .....	5

Changes from Revision I (March, 2009) to Revision J	Page
• Changed <a href="#">Figure 12</a> .....	7
• Added paragraph about recommended start-up sequence to <i>Internal Current Limit</i> section .....	12
• Added paragraph about current foldback and device start-up to <i>Enable Pin and Shutdown</i> section .....	12

**PACKAGING INFORMATION**

Orderable Device	Status <sup>(1)</sup>	Package Type	Package Drawing	Pins	Package Qty	Eco Plan <sup>(2)</sup>	Lead/Ball Finish	MSL Peak Temp <sup>(3)</sup>
TPS73701DCQ	ACTIVE	SOT-223	DCQ	6	78	Green (RoHS & no Sb/Br)	CU NIPDAU	Level-2-260C-1 YEAR
TPS73701DCQG4	ACTIVE	SOT-223	DCQ	6	78	Green (RoHS & no Sb/Br)	CU NIPDAU	Level-2-260C-1 YEAR
TPS73701DCQR	ACTIVE	SOT-223	DCQ	6	2500	Green (RoHS & no Sb/Br)	CU NIPDAU	Level-2-260C-1 YEAR
TPS73701DCQRG4	ACTIVE	SOT-223	DCQ	6	2500	Green (RoHS & no Sb/Br)	CU NIPDAU	Level-2-260C-1 YEAR
TPS73701DRBR	ACTIVE	SON	DRB	8	3000	Green (RoHS & no Sb/Br)	CU NIPDAU	Level-2-260C-1 YEAR
TPS73701DRBRG4	ACTIVE	SON	DRB	8	3000	Green (RoHS & no Sb/Br)	CU NIPDAU	Level-2-260C-1 YEAR
TPS73701DRBT	ACTIVE	SON	DRB	8	250	Green (RoHS & no Sb/Br)	CU NIPDAU	Level-2-260C-1 YEAR
TPS73701DRBTG4	ACTIVE	SON	DRB	8	250	Green (RoHS & no Sb/Br)	CU NIPDAU	Level-2-260C-1 YEAR
TPS73701DRVR	PREVIEW	SON	DRV	6	3000	TBD	Call TI	Call TI
TPS73701DRVT	PREVIEW	SON	DRV	6	250	TBD	Call TI	Call TI
TPS73718DCQ	ACTIVE	SOT-223	DCQ	6	78	Green (RoHS & no Sb/Br)	CU NIPDAU	Level-2-260C-1 YEAR
TPS73718DCQG4	ACTIVE	SOT-223	DCQ	6	78	Green (RoHS & no Sb/Br)	CU NIPDAU	Level-2-260C-1 YEAR
TPS73718DCQR	ACTIVE	SOT-223	DCQ	6	2500	Green (RoHS & no Sb/Br)	CU NIPDAU	Level-2-260C-1 YEAR
TPS73718DCQRG4	ACTIVE	SOT-223	DCQ	6	2500	Green (RoHS & no Sb/Br)	CU NIPDAU	Level-2-260C-1 YEAR
TPS73725DCQ	ACTIVE	SOT-223	DCQ	6	78	Green (RoHS & no Sb/Br)	CU NIPDAU	Level-2-260C-1 YEAR
TPS73725DCQG4	ACTIVE	SOT-223	DCQ	6	78	Green (RoHS & no Sb/Br)	CU NIPDAU	Level-2-260C-1 YEAR
TPS73725DCQR	ACTIVE	SOT-223	DCQ	6	2500	Green (RoHS & no Sb/Br)	CU NIPDAU	Level-2-260C-1 YEAR
TPS73725DCQRG4	ACTIVE	SOT-223	DCQ	6	2500	Green (RoHS & no Sb/Br)	CU NIPDAU	Level-2-260C-1 YEAR
TPS73730DRBR	ACTIVE	SON	DRB	8	3000	Green (RoHS & no Sb/Br)	CU NIPDAU	Level-2-260C-1 YEAR
TPS73730DRBT	ACTIVE	SON	DRB	8	250	Green (RoHS & no Sb/Br)	CU NIPDAU	Level-2-260C-1 YEAR
TPS73733DCQ	ACTIVE	SOT-223	DCQ	6	78	Green (RoHS & no Sb/Br)	CU NIPDAU	Level-2-260C-1 YEAR
TPS73733DCQG4	ACTIVE	SOT-223	DCQ	6	78	Green (RoHS & no Sb/Br)	CU NIPDAU	Level-2-260C-1 YEAR
TPS73733DCQR	ACTIVE	SOT-223	DCQ	6	2500	Green (RoHS & no Sb/Br)	CU NIPDAU	Level-2-260C-1 YEAR
TPS73733DCQRG4	ACTIVE	SOT-223	DCQ	6	2500	Green (RoHS & no Sb/Br)	CU NIPDAU	Level-2-260C-1 YEAR
TPS73734DCQ	ACTIVE	SOT-223	DCQ	6	78	Green (RoHS & no Sb/Br)	CU NIPDAU	Level-2-260C-1 YEAR
TPS73734DCQR	ACTIVE	SOT-223	DCQ	6	2500	Green (RoHS & no Sb/Br)	CU NIPDAU	Level-2-260C-1 YEAR

Orderable Device	Status <sup>(1)</sup>	Package Type	Package Drawing	Pins	Package Qty	Eco Plan <sup>(2)</sup>	Lead/Ball Finish	MSL Peak Temp <sup>(3)</sup>
no Sb/Br)								

<sup>(1)</sup> The marketing status values are defined as follows:

**ACTIVE:** Product device recommended for new designs.

**LIFEBUY:** TI has announced that the device will be discontinued, and a lifetime-buy period is in effect.

**NRND:** Not recommended for new designs. Device is in production to support existing customers, but TI does not recommend using this part in a new design.

**PREVIEW:** Device has been announced but is not in production. Samples may or may not be available.

**OBSOLETE:** TI has discontinued the production of the device.

<sup>(2)</sup> Eco Plan - The planned eco-friendly classification: Pb-Free (RoHS), Pb-Free (RoHS Exempt), or Green (RoHS & no Sb/Br) - please check <http://www.ti.com/productcontent> for the latest availability information and additional product content details.

**TBD:** The Pb-Free/Green conversion plan has not been defined.

**Pb-Free (RoHS):** TI's terms "Lead-Free" or "Pb-Free" mean semiconductor products that are compatible with the current RoHS requirements for all 6 substances, including the requirement that lead not exceed 0.1% by weight in homogeneous materials. Where designed to be soldered at high temperatures, TI Pb-Free products are suitable for use in specified lead-free processes.

**Pb-Free (RoHS Exempt):** This component has a RoHS exemption for either 1) lead-based flip-chip solder bumps used between the die and package, or 2) lead-based die adhesive used between the die and leadframe. The component is otherwise considered Pb-Free (RoHS compatible) as defined above.

**Green (RoHS & no Sb/Br):** TI defines "Green" to mean Pb-Free (RoHS compatible), and free of Bromine (Br) and Antimony (Sb) based flame retardants (Br or Sb do not exceed 0.1% by weight in homogeneous material)

<sup>(3)</sup> MSL, Peak Temp. -- The Moisture Sensitivity Level rating according to the JEDEC industry standard classifications, and peak solder temperature.

**Important Information and Disclaimer:** The information provided on this page represents TI's knowledge and belief as of the date that it is provided. TI bases its knowledge and belief on information provided by third parties, and makes no representation or warranty as to the accuracy of such information. Efforts are underway to better integrate information from third parties. TI has taken and continues to take reasonable steps to provide representative and accurate information but may not have conducted destructive testing or chemical analysis on incoming materials and chemicals. TI and TI suppliers consider certain information to be proprietary, and thus CAS numbers and other limited information may not be available for release.

In no event shall TI's liability arising out of such information exceed the total purchase price of the TI part(s) at issue in this document sold by TI to Customer on an annual basis.

**OTHER QUALIFIED VERSIONS OF TPS73733 :**

- Automotive: [TPS73733-Q1](#)

NOTE: Qualified Version Definitions:

- Automotive - Q100 devices qualified for high-reliability automotive applications targeting zero defects



**TAPE AND REEL INFORMATION**

**QUADRANT ASSIGNMENTS FOR PIN 1 ORIENTATION IN TAPE**

\*All dimensions are nominal

Device	Package Type	Package Drawing	Pins	SPQ	Reel Diameter (mm)	Reel Width W1 (mm)	A0 (mm)	B0 (mm)	K0 (mm)	P1 (mm)	W (mm)	Pin1 Quadrant
TPS73701DCQR	SOT-223	DCQ	6	2500	330.0	12.4	6.8	7.3	1.88	8.0	12.0	Q3
TPS73701DRBR	SON	DRB	8	3000	330.0	12.4	3.3	3.3	1.1	8.0	12.0	Q2
TPS73701DRBT	SON	DRB	8	250	180.0	12.4	3.3	3.3	1.1	8.0	12.0	Q2
TPS73718DCQR	SOT-223	DCQ	6	2500	330.0	12.4	6.8	7.3	1.88	8.0	12.0	Q3
TPS73725DCQR	SOT-223	DCQ	6	2500	330.0	12.4	6.8	7.3	1.88	8.0	12.0	Q3
TPS73730DRBR	SON	DRB	8	3000	330.0	12.4	3.3	3.3	1.1	8.0	12.0	Q2
TPS73730DRBT	SON	DRB	8	250	180.0	12.4	3.3	3.3	1.1	8.0	12.0	Q2
TPS73733DCQR	SOT-223	DCQ	6	2500	330.0	12.4	6.8	7.3	1.88	8.0	12.0	Q3
TPS73734DCQR	SOT-223	DCQ	6	2500	330.0	12.4	6.8	7.3	1.88	8.0	12.0	Q3

**TAPE AND REEL BOX DIMENSIONS**

\*All dimensions are nominal

Device	Package Type	Package Drawing	Pins	SPQ	Length (mm)	Width (mm)	Height (mm)
TPS73701DCQR	SOT-223	DCQ	6	2500	358.0	335.0	35.0
TPS73701DRBR	SON	DRB	8	3000	346.0	346.0	29.0
TPS73701DRBT	SON	DRB	8	250	190.5	212.7	31.8
TPS73718DCQR	SOT-223	DCQ	6	2500	358.0	335.0	35.0
TPS73725DCQR	SOT-223	DCQ	6	2500	358.0	335.0	35.0
TPS73730DRBR	SON	DRB	8	3000	346.0	346.0	29.0
TPS73730DRBT	SON	DRB	8	250	190.5	212.7	31.8
TPS73733DCQR	SOT-223	DCQ	6	2500	358.0	335.0	35.0
TPS73734DCQR	SOT-223	DCQ	6	2500	358.0	335.0	35.0

DCQ (R-PDSO-G6)

PLASTIC SMALL-OUTLINE

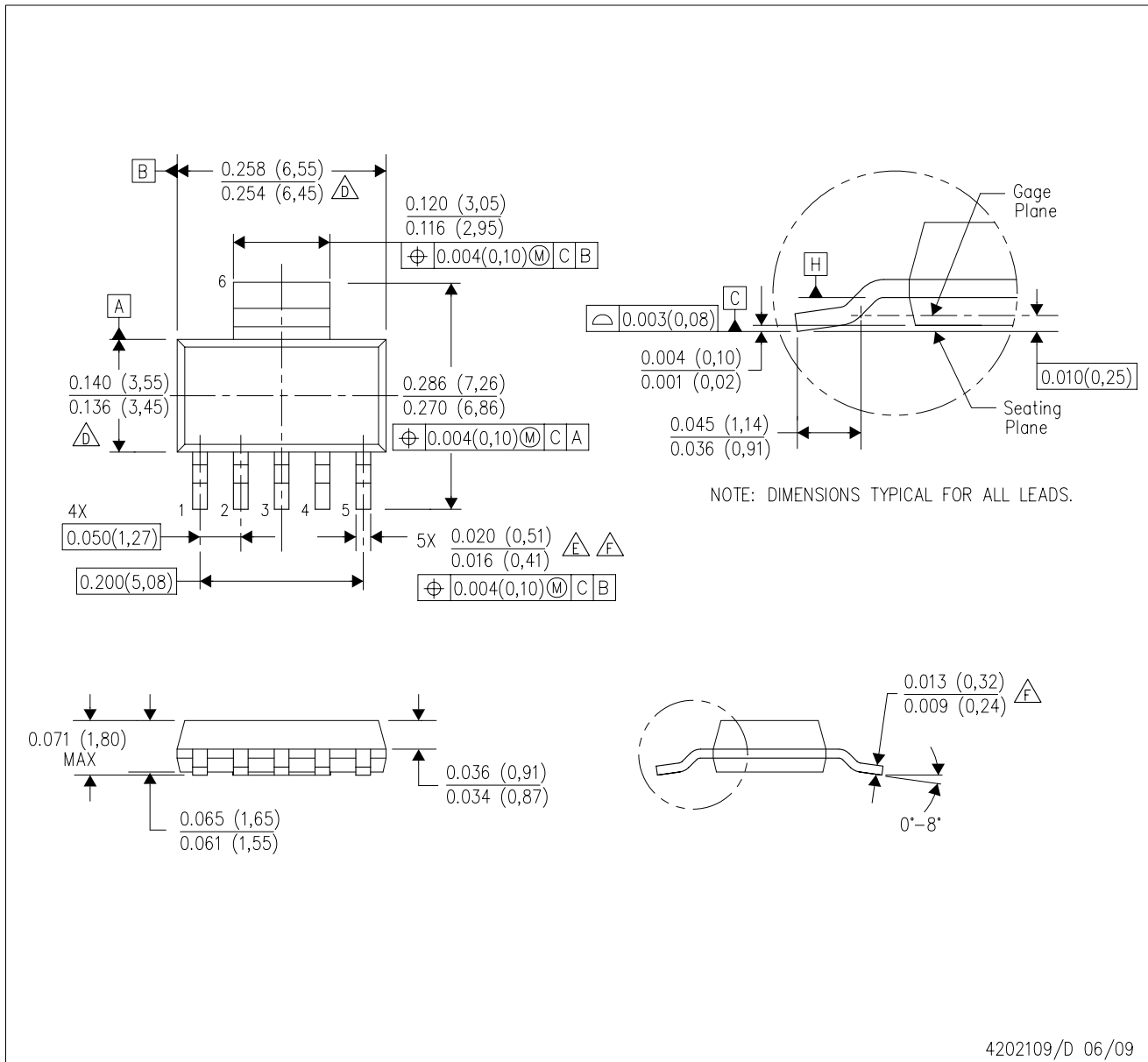



4202109/D 06/09

- NOTES:
- A. All linear dimensions are in inches (millimeters).
  - B. This drawing is subject to change without notice.
  - C. Controlling dimension in inches.
  - $\triangle D$  Body length and width dimensions are determined at the outermost extremes of the plastic body exclusive of mold flash, tie bar burrs, gate burrs, and interlead flash, but including any mismatch between the top and the bottom of the plastic body.
  - $\triangle E$  Lead width dimension does not include dambar protrusion.
  - $\triangle F$  Lead width and thickness dimensions apply to solder plated leads.
  - G. Interlead flash allow 0.008 inch max.
  - H. Gate burr/protrusion max. 0.006 inch.
  - I. Datums A and B are to be determined at Datum H.

DRB (S-PVSON-N8)

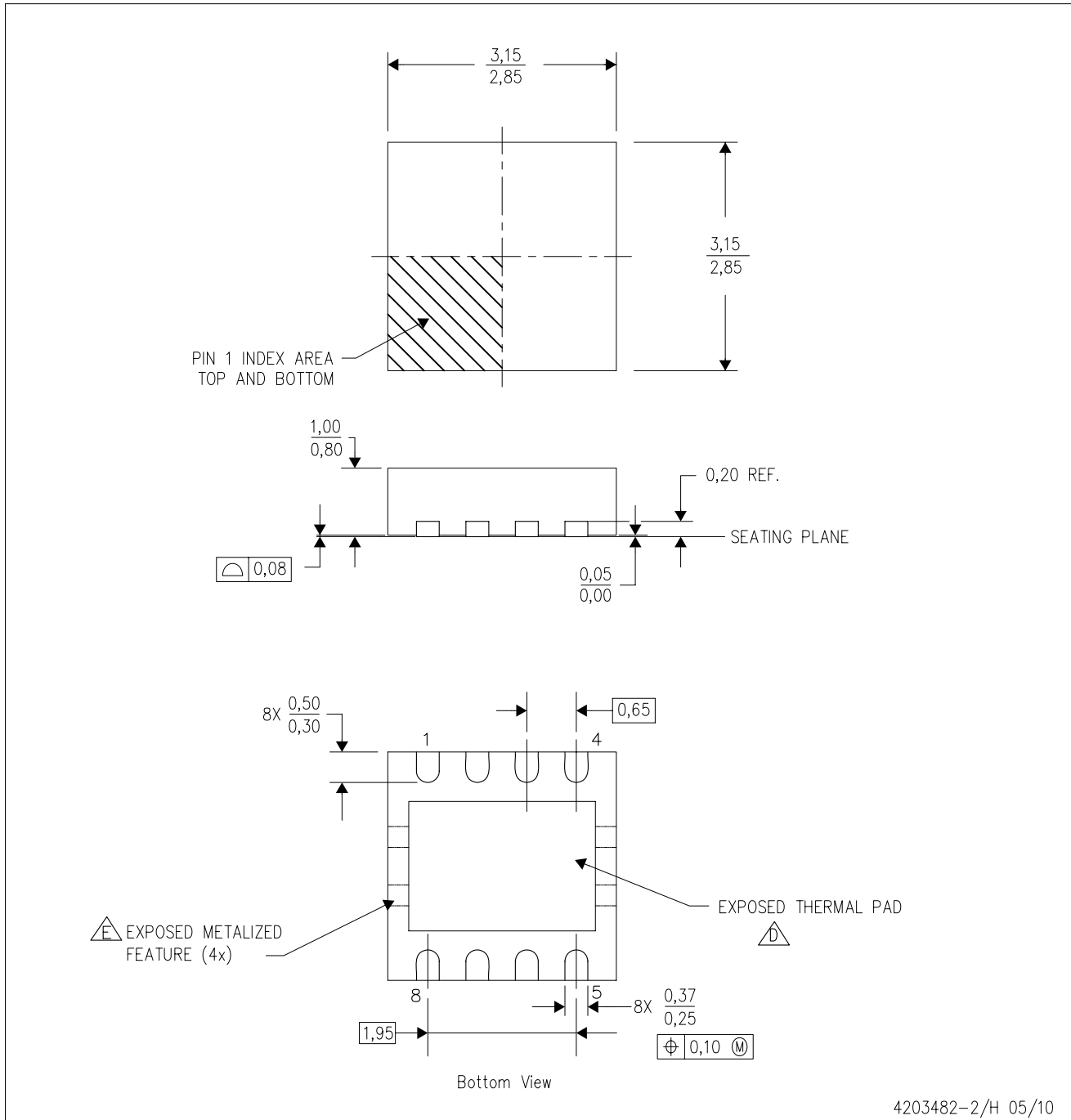
PLASTIC SMALL OUTLINE NO-LEAD



- NOTES:
- A. All linear dimensions are in millimeters. Dimensioning and tolerancing per ASME Y14.5M-1994.
  - B. This drawing is subject to change without notice.
  - C. Small Outline No-Lead (SON) package configuration.
  -  The package thermal pad must be soldered to the board for thermal and mechanical performance. See the Product Data Sheet for details regarding the exposed thermal pad dimensions.
  -  Metalized features are supplier options and may not be on the package.

## THERMAL PAD MECHANICAL DATA

DRB (S-PVSON-N8)

PLASTIC SMALL OUTLINE

### THERMAL INFORMATION

This package incorporates an exposed thermal pad that is designed to be attached directly to an external heatsink. The thermal pad must be soldered directly to the printed circuit board (PCB). After soldering, the PCB can be used as a heatsink. In addition, through the use of thermal vias, the thermal pad can be attached directly to the appropriate copper plane shown in the electrical schematic for the device, or alternatively, can be attached to a special heatsink structure designed into the PCB. This design optimizes the heat transfer from the integrated circuit (IC).

For information on the Quad Flatpack No-Lead (QFN) package and its advantages, refer to Application Report, QFN/SON PCB Attachment, Texas Instruments Literature No. SLUA271. This document is available at [www.ti.com](http://www.ti.com).

The exposed thermal pad dimensions for this package are shown in the following illustration.

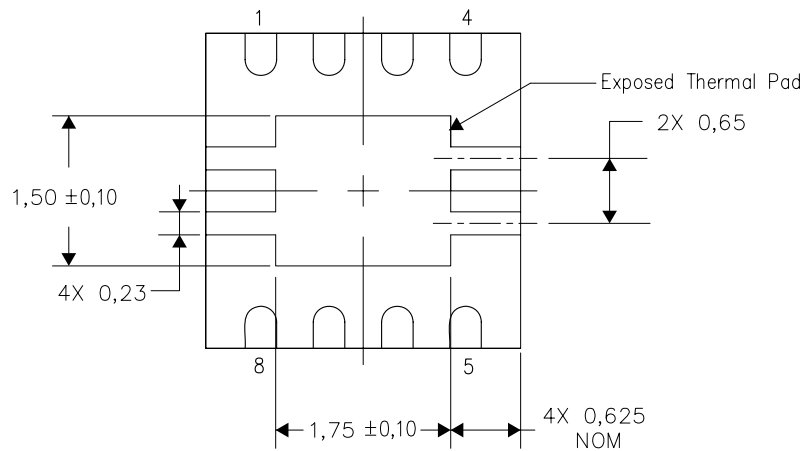

Bottom View

NOTE: All linear dimensions are in millimeters

Exposed Thermal Pad Dimensions

4206340-2/1 03/10

DRB (S-PVSON-N8)

PLASTIC SMALL OUTLINE

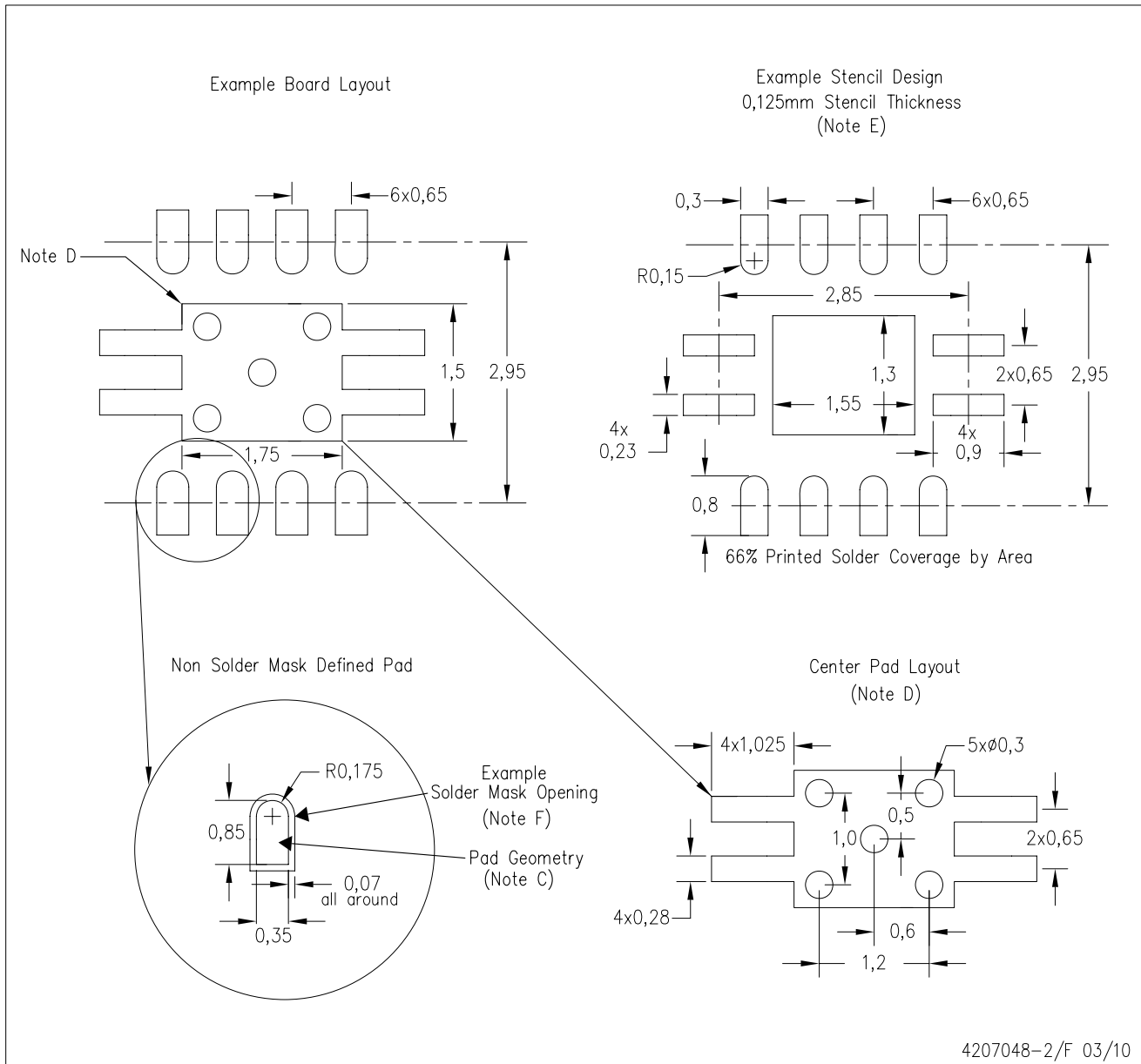

- NOTES:
- All linear dimensions are in millimeters.
  - This drawing is subject to change without notice.
  - Publication IPC-7351 is recommended for alternate designs.
  - This package is designed to be soldered to a thermal pad on the board. Refer to Application Note, QFN Packages, Texas Instruments Literature No. SLUA271, and also the Product Data Sheets for specific thermal information, via requirements, and recommended board layout. These documents are available at [www.ti.com](http://www.ti.com) <<http://www.ti.com>>.
  - Laser cutting apertures with trapezoidal walls and also rounding corners will offer better paste release. Customers should contact their board assembly site for stencil design recommendations. Refer to IPC 7525 for stencil design considerations.
  - Customers should contact their board fabrication site for solder mask tolerances.

DRV (S-PDSO-N6)

PLASTIC SMALL OUTLINE

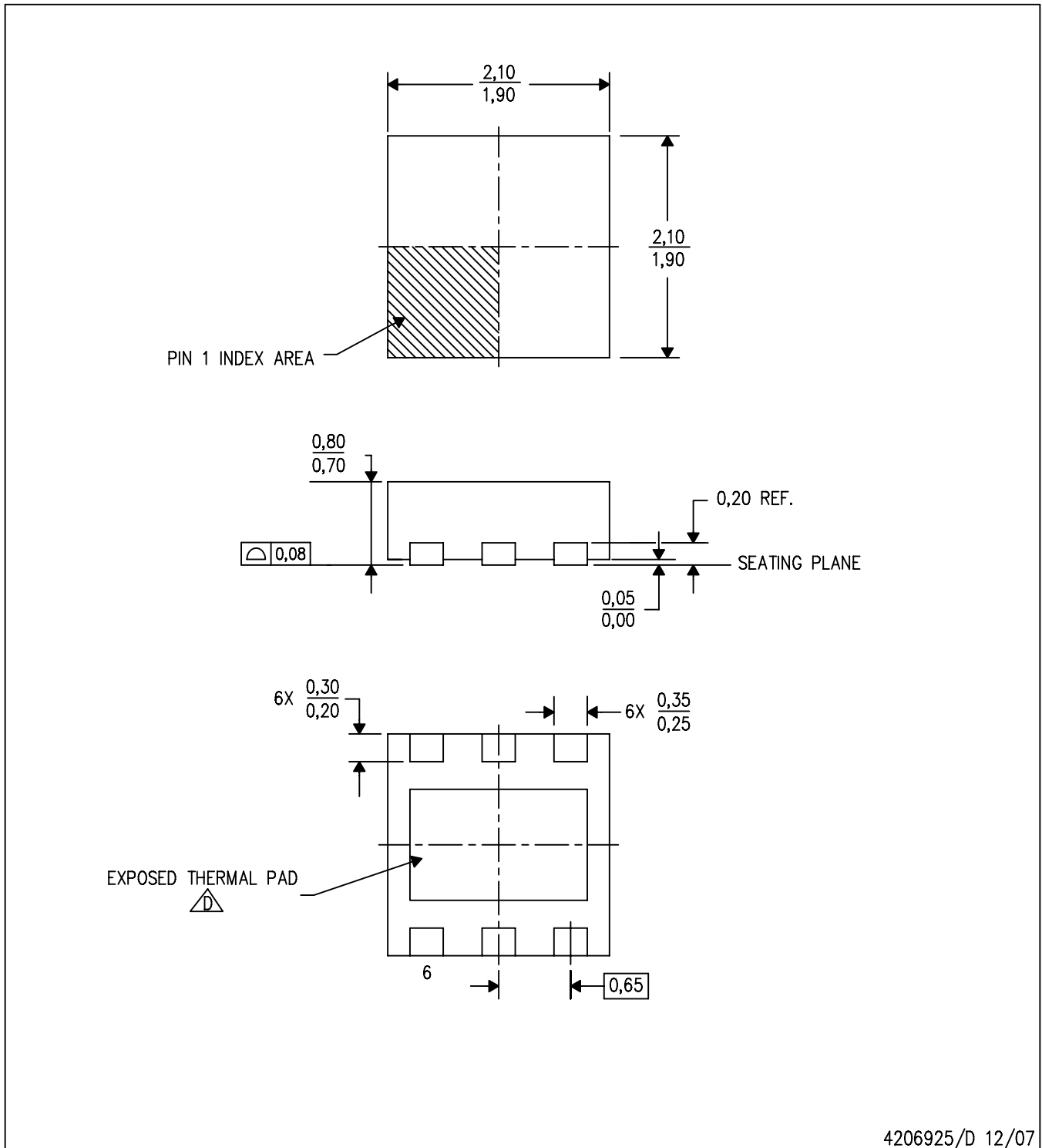

- NOTES:
- A. All linear dimensions are in millimeters. Dimensioning and tolerancing per ASME Y14.5M-1994.
  - B. This drawing is subject to change without notice.
  - C. Small Outline No-Lead (SON) package configuration.
-  The package thermal pad must be soldered to the board for thermal and mechanical performance. See the Product Data Sheet for details regarding the exposed thermal pad dimensions.

## IMPORTANT NOTICE

Texas Instruments Incorporated and its subsidiaries (TI) reserve the right to make corrections, modifications, enhancements, improvements, and other changes to its products and services at any time and to discontinue any product or service without notice. Customers should obtain the latest relevant information before placing orders and should verify that such information is current and complete. All products are sold subject to TI's terms and conditions of sale supplied at the time of order acknowledgment.

TI warrants performance of its hardware products to the specifications applicable at the time of sale in accordance with TI's standard warranty. Testing and other quality control techniques are used to the extent TI deems necessary to support this warranty. Except where mandated by government requirements, testing of all parameters of each product is not necessarily performed.

TI assumes no liability for applications assistance or customer product design. Customers are responsible for their products and applications using TI components. To minimize the risks associated with customer products and applications, customers should provide adequate design and operating safeguards.

TI does not warrant or represent that any license, either express or implied, is granted under any TI patent right, copyright, mask work right, or other TI intellectual property right relating to any combination, machine, or process in which TI products or services are used. Information published by TI regarding third-party products or services does not constitute a license from TI to use such products or services or a warranty or endorsement thereof. Use of such information may require a license from a third party under the patents or other intellectual property of the third party, or a license from TI under the patents or other intellectual property of TI.

Reproduction of TI information in TI data books or data sheets is permissible only if reproduction is without alteration and is accompanied by all associated warranties, conditions, limitations, and notices. Reproduction of this information with alteration is an unfair and deceptive business practice. TI is not responsible or liable for such altered documentation. Information of third parties may be subject to additional restrictions.

Resale of TI products or services with statements different from or beyond the parameters stated by TI for that product or service voids all express and any implied warranties for the associated TI product or service and is an unfair and deceptive business practice. TI is not responsible or liable for any such statements.

TI products are not authorized for use in safety-critical applications (such as life support) where a failure of the TI product would reasonably be expected to cause severe personal injury or death, unless officers of the parties have executed an agreement specifically governing such use. Buyers represent that they have all necessary expertise in the safety and regulatory ramifications of their applications, and acknowledge and agree that they are solely responsible for all legal, regulatory and safety-related requirements concerning their products and any use of TI products in such safety-critical applications, notwithstanding any applications-related information or support that may be provided by TI. Further, Buyers must fully indemnify TI and its representatives against any damages arising out of the use of TI products in such safety-critical applications.

TI products are neither designed nor intended for use in military/aerospace applications or environments unless the TI products are specifically designated by TI as military-grade or "enhanced plastic." Only products designated by TI as military-grade meet military specifications. Buyers acknowledge and agree that any such use of TI products which TI has not designated as military-grade is solely at the Buyer's risk, and that they are solely responsible for compliance with all legal and regulatory requirements in connection with such use.

TI products are neither designed nor intended for use in automotive applications or environments unless the specific TI products are designated by TI as compliant with ISO/TS 16949 requirements. Buyers acknowledge and agree that, if they use any non-designated products in automotive applications, TI will not be responsible for any failure to meet such requirements.

Following are URLs where you can obtain information on other Texas Instruments products and application solutions:

<b>Products</b>		<b>Applications</b>	
Amplifiers	<a href="http://amplifier.ti.com">amplifier.ti.com</a>	Audio	<a href="http://www.ti.com/audio">www.ti.com/audio</a>
Data Converters	<a href="http://dataconverter.ti.com">dataconverter.ti.com</a>	Automotive	<a href="http://www.ti.com/automotive">www.ti.com/automotive</a>
DLP® Products	<a href="http://www.dlp.com">www.dlp.com</a>	Communications and Telecom	<a href="http://www.ti.com/communications">www.ti.com/communications</a>
DSP	<a href="http://dsp.ti.com">dsp.ti.com</a>	Computers and Peripherals	<a href="http://www.ti.com/computers">www.ti.com/computers</a>
Clocks and Timers	<a href="http://www.ti.com/clocks">www.ti.com/clocks</a>	Consumer Electronics	<a href="http://www.ti.com/consumer-apps">www.ti.com/consumer-apps</a>
Interface	<a href="http://interface.ti.com">interface.ti.com</a>	Energy	<a href="http://www.ti.com/energy">www.ti.com/energy</a>
Logic	<a href="http://logic.ti.com">logic.ti.com</a>	Industrial	<a href="http://www.ti.com/industrial">www.ti.com/industrial</a>
Power Mgmt	<a href="http://power.ti.com">power.ti.com</a>	Medical	<a href="http://www.ti.com/medical">www.ti.com/medical</a>
Microcontrollers	<a href="http://microcontroller.ti.com">microcontroller.ti.com</a>	Security	<a href="http://www.ti.com/security">www.ti.com/security</a>
RFID	<a href="http://www.ti-rfid.com">www.ti-rfid.com</a>	Space, Avionics & Defense	<a href="http://www.ti.com/space-avionics-defense">www.ti.com/space-avionics-defense</a>
RF/IF and ZigBee® Solutions	<a href="http://www.ti.com/lprf">www.ti.com/lprf</a>	Video and Imaging	<a href="http://www.ti.com/video">www.ti.com/video</a>
		Wireless	<a href="http://www.ti.com/wireless-apps">www.ti.com/wireless-apps</a>

Mailing Address: Texas Instruments, Post Office Box 655303, Dallas, Texas 75265  
Copyright © 2010, Texas Instruments Incorporated

[www.BDTIC.com/TI](http://www.BDTIC.com/TI)