

TPS73HD301, TPS73HD318, TPS73HD325 DUAL-OUTPUT LOW-DROPOUT VOLTAGE REGULATORS

SLVS167C – SEPTEMBER 1998 – REVISED – MAY 1999

- Dual Output Voltages for Split-Supply Applications
- 3.3-V/Adjustable Output, 3.3 V/1.8 V, and 3.3 V/2.5
- Dropout Voltage < 80 mV Max at $I_O = 100$ mA (3.3-V option)
- Low Quiescent Current, Independent of Load . . . 340 μ A Typ Per Regulator
- Ultra-Low-Current Sleep State . . . 2 μ A Max
- Dual Active-Low Reset Signals with 200-ms Pulse Width
- Output Current Range of 0 mA to 750 mA Per Regulator
- 28-Pin PowerPAD™ TSSOP Package

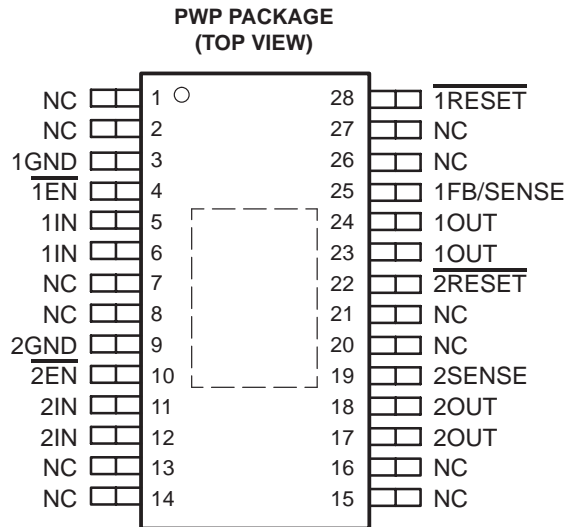

description

NC – No internal connection

The TPS73HD3xx family of dual voltage regulators offers very low dropout voltages and dual outputs in a compact package. Designed primarily for DSP applications, these devices can be used in any mixed-output voltage application with each regulator supporting up to 750 mA. Output current can be allocated as desired between the two regulators and used to power many of today's DSPs. Low quiescent current and very low dropout voltage assure maximum power usage in battery-powered applications. Texas Instruments PowerPAD TSSOP package allows use of these devices with any voltage/current combination within the range of the listed specifications without thermal problems, provided proper device mounting procedures are followed. Separate inputs allow the designer to configure the source power as desired. Dual active-low reset signals allow resetting of core-logic and I/O separately. Remote sense/feedback terminals provide regulation at the load. The TPS73HD3xx are available in 28-pin PowerPAD TSSOP. They operate over a free-air temperature range of -40°C to 125°C .

AVAILABLE OPTIONS

T_A	REGULATOR 1 V_O (V)	REGULATOR 2 V_O (V)	TSSOP (PWP)
-40°C to 125°C	Adj (1.2 – 9.75 V)	3.3 V	TPS73HD301PWPR
	1.8 V	3.3 V	TPS73HD318PWPR
	2.5 V	3.3 V	TPS73HD325PWPR



Please be aware that an important notice concerning availability, standard warranty, and use in critical applications of Texas Instruments semiconductor products and disclaimers thereto appears at the end of this data sheet.

PowerPAD is a trademark of Texas Instruments Incorporated.

PRODUCTION DATA information is current as of publication date. Products conform to specifications per the terms of Texas Instruments standard warranty. Production processing does not necessarily include testing of all parameters.

Copyright © 1999, Texas Instruments Incorporated

www.BDTC.com/TI

POST OFFICE BOX 655303 • DALLAS, TEXAS 75265

TPS73HD301, TPS73HD318, TPS73HD325 DUAL-OUTPUT LOW-DROPOUT VOLTAGE REGULATORS

SLVS167C – SEPTEMBER 1998 – REVISED – MAY 1999

functional block diagram

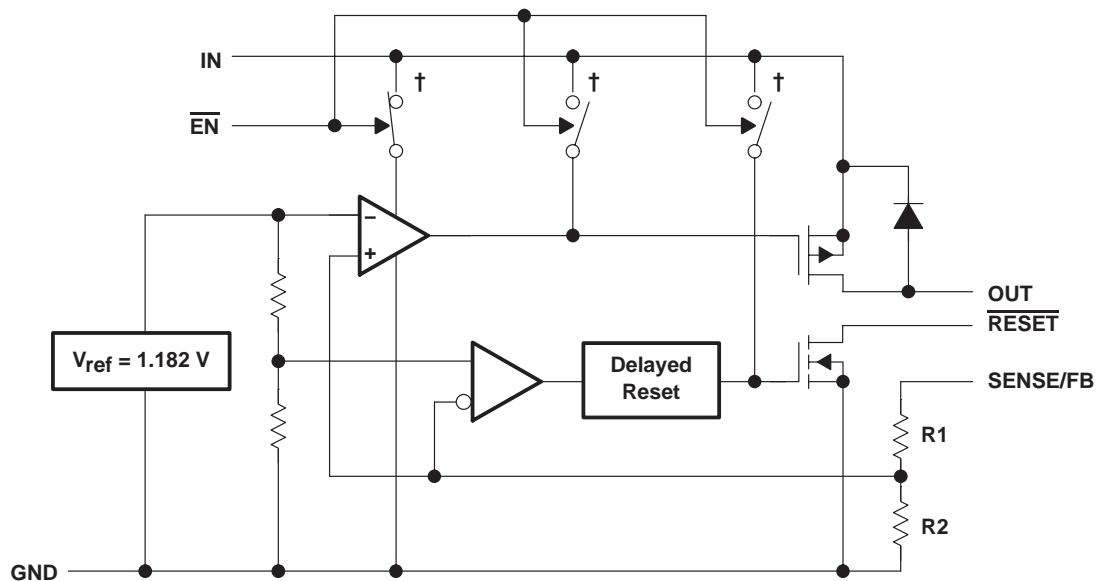

† Switch positions shown with \overline{EN} low (active).

OUTPUT VOLTAGE	R1	R2	UNIT
Adjustable	0	∞	Ω
1.8 V	122	233	k Ω
2.5 V	260	233	k Ω
3.3 V	420	233	k Ω

Terminal Functions

TERMINAL NAME	NO.	I/O	DESCRIPTION
NC	1, 2, 7, 8, 13–16, 20, 21, 26, 27		No connection
1GND	3		Regulator #1 ground
$\overline{1EN}$	4	I	Regulator #1 enable, low = enable
1IN	5, 6	I	Regulator #1 input supply voltage
2GND	9		Regulator #2 ground
$\overline{2EN}$	10	I	Regulator #2 enable, low = enable
2IN	11, 12	I	Regulator #2 input supply voltage
2OUT	17, 18	O	Regulator #2 output voltage
2SENSE	19	I	Regulator #2 output voltage sense (fixed output)
$\overline{2RESET}$	22	O	Regulator #2 reset signal, low = reset
1OUT	23, 24	O	Regulator #1 output voltage
1FB/SENSE	25	I	Regulator #1 output voltage feedback (adjustable output)
$\overline{1RESET}$	28	O	Regulator #1 reset signal, low = reset

TPS73HD301, TPS73HD318, TPS73HD325 DUAL-OUTPUT LOW-DROPOUT VOLTAGE REGULATORS

SLVS167C – SEPTEMBER 1998 – REVISED – MAY 1999

absolute maximum ratings over operating free-air temperature (unless otherwise noted)[†]

Input voltage range, V_I (\overline{xIN} , \overline{xRESET} , \overline{xSENSE} , \overline{xEN})	–0.3 V to 11 V
Differential input voltage, V_{ID} (1GND to 2GND)	2 V
Output current, I_O (1OUT, 2OUT)	2 A
Continuous total power dissipation	See Dissipation Rating Tables
Operating free-air temperature range, T_A	–40°C to 125°C
Storage temperature range, T_{stg}	–65°C to 150°C
Lead temperature soldering 1,6 mm (1/16 inch) from case for 10 seconds	260°C

[†] Stresses beyond those listed under “absolute maximum ratings” may cause permanent damage to the device. These are stress ratings only, and functional operation of the device at these or any other conditions beyond those indicated under “recommended operating conditions” is not implied. Exposure to absolute-maximum-rated conditions for extended periods may affect device reliability.

NOTE 1: All voltages are with respect to GND.

DISSIPATION RATING TABLE 1 – FREE-AIR TEMPERATURES[‡]

PACKAGE	AIR FLOW (CFM)	$T_A < 25^\circ\text{C}$ POWER RATING	DERATING FACTOR ABOVE $T_A = 25^\circ\text{C}$	$T_A = 70^\circ\text{C}$ POWER RATING	$T_A = 85^\circ\text{C}$ POWER RATING
PWP [‡]	0	2.9 W	23.5 mW/°C	1.9 W	1.5 W
	300	4.3 W	34.6 mW/°C	2.8 W	2.2 W
PWP [§]	0	3 W	23.8 mW/°C	1.9 W	1.5 W
	300	7.2 W	57.9 mW/°C	4.6 W	3.8 W

[‡] This parameter is measured with the recommended copper heat sink pattern on a 1-layer PCB, 5-in × 5-in PCB, 1 oz. copper, 2-in × 2-in coverage (4 in²).

[§] This parameter is measured with the recommended copper heat sink pattern on a 8-layer PCB, 1.5-in × 2-in PCB, 1 oz. copper with layers 1, 2, 4, 5, 7, and 8 at 5% coverage (0.9 in²) and layers 3 and 6 at 100% coverage (6 in²).

recommended operating conditions

		MIN	MAX	UNIT
Input voltage, V_I [†]	Adjustable output (regulator #1)	2.97	10	V
Input voltage, V_I [†]	3.3-V output (regulator #2)	3.97	10	V
High-level input voltage at \overline{EN} , V_{IH}		2		V
Low-level input voltage at \overline{EN} , V_{IL}			0.5	V
Total output current range (per regulator), I_O		0	750	mA
Operating virtual junction temperature range, T_J		–40	125	°C

[†] Minimum input voltage defined in the recommended operating conditions is the maximum specified output voltage plus dropout voltage, V_{DO} , at the maximum specified load range (750 mA). Since dropout voltage is a function of output current, the usable range can be extended for lighter loads. To calculate the minimum input voltage for the maximum load current used in a given application, use the following equation:

$$V_{I(\min)} = V_{O(\max)} + V_{DO(\max \text{ load})}$$

Because regulator 1 of the TPS73HD301 is programmable, $r_{DS(on)}$ should be used to calculate V_{DO} before applying the above equation. The equation for calculating V_{DO} from $r_{DS(on)}$ is given in Note 3 in the TPS73HD301 electrical characteristics table. The minimum value of 3.5 V is the absolute lower limit for the recommended input voltage range for the TPS73HD301. With 2.97-V input voltage, the LDO may be in dropout and will not meet the 3% regulator output or 750-mA load current specification.

TPS73HD301, TPS73HD318, TPS73HD325 DUAL-OUTPUT LOW-DROPOUT VOLTAGE REGULATORS

SLVS167C – SEPTEMBER 1998 – REVISED – MAY 1999

electrical characteristics, $V_{I(IN)} = 4.3\text{ V}$, $I_O = 10\text{ mA}$, $\overline{EN} = 0\text{ V}$, $C_O = 4.7\text{ }\mu\text{F}/\text{CSR}^\ddagger = 1\text{ }\Omega$,
SENSE/FB shorted to OUT (unless otherwise noted)

PARAMETER	TEST CONDITIONS [§]	T _J	MIN	TYP	MAX	UNIT
Quiescent current (active mode), each regulator	$\overline{EN} \leq 0.5\text{ V}$, $0\text{ mA} \leq I_O \leq 750\text{ mA}$, See NOTE 2	25°C		340	415	μA
		-40°C to 125°C			550	
I _{CC} Supply current (standby mode), each regulator	$\overline{EN} = V_I$, NOTE 2	25°C		0.01	0.5	μA
		-40°C to 125°C			2	
I _O Output current limit, each regulator	V _O = 0, V _I = 10 V	25°C	0.8	1.2	2	A
		-40°C to 125°C			2	
I _{lkg} Pass-element leakage current (standby mode)	$\overline{EN} = V_I$, See NOTE 2	25°C		0.01	0.5	μA
		-40°C to 125°C			1	
Output voltage temperature coefficient		-40°C to 125°C		61	75	ppm/°C
Thermal shutdown junction temperature				165		°C
Logic high (\overline{EN}) (standby mode)	2.5 V ≤ V _I ≤ 6 V, 6 V ≤ V _I ≤ 10 V	-40°C to 125°C	2			V
			2.7			
Logic low (\overline{EN}) (active mode)	See NOTE 2	25°C			0.5	V
		-40°C to 125°C			0.5	
V _{hys} Hysteresis voltage (\overline{EN})		25°C		50		mV
I _I Input current (\overline{EN})	0 V ≤ V _I ≤ 10 V	25°C	-0.5	0.001	0.5	μA
		-40°C to 125°C	-0.5		0.5	
Minimum input voltage, for active pass element		25°C		2.05	2.5	V
		-40°C to 125°C			2.5	
Minimum input voltage, for valid \overline{RESET}	I _{O(RESET)} = -300 μA	25°C		1	1.5	V
		-40°C to 125°C			1.9	

[‡] CSR (compensation series resistance) refers to the total series resistance, including the equivalent series resistance (ESR) of the capacitor, any series resistance added externally, and PWB trace resistance to C_O.

[§] Pulse-testing techniques are used to maintain virtual junction temperature as close as possible to ambient temperature; thermal effects must be taken into account separately.

NOTE 2: Minimum input voltage is 3.5V or V_O(typ) + 1V whichever is greater.

The minimum value of 3.5 V is the absolute lower limit for the recommended input voltage range for the TPS73HD301.

TPS73HD301, TPS73HD318, TPS73HD325 DUAL-OUTPUT LOW-DROPOUT VOLTAGE REGULATORS

SLVS167C – SEPTEMBER 1998 – REVISED – MAY 1999

electrical characteristics, $V_{I(IN)} = 4.3\text{ V}$, $I_O = 10\text{ mA}$, $\overline{EN} = 0\text{ V}$, $C_O = 4.7\text{ }\mu\text{F/CSR}^\dagger = 1\text{ }\Omega$,
SENSE/FB shorted to OUT (unless otherwise noted) (continued)

adjustable regulator

PARAMETER	TEST CONDITIONS [‡]	T _J	MIN	TYP	MAX	UNIT	
Reference voltage (1FB)	5 mA ≤ I _O ≤ 750 mA, See NOTE 2	25°C	1.182		1.217	V	
		–40°C to 125°C	1.147				
Reference voltage temperature coefficient		–40°C to 125°C		61	75	ppm/°C	
Pass-element series resistance (see Note 3)	50 μA ≤ I _O ≤ 750 mA, See NOTE 2	25°C	0.52		1	Ω	
		–40°C to 125°C			1		
		V _I = 3.9 V, 50 μA ≤ I _O ≤ 750 mA	25°C	0.32			
	V _I = 5.9 V, 50 μA ≤ I _O ≤ 750 mA	25°C	0.23				
Input regulation	V _I = 3.5 V, 50 μA ≤ I _O ≤ 750 mA	25°C	3			mV	
Output regulation	I _O = 5 mA to 750 mA, See NOTE 2	25°C	7			mV	
	I _O = 50 μA to 750 mA, See NOTE 2	25°C	10			mV	
Ripple rejection	f = 120 Hz, I _O = 50 μA	25°C	59			dB	
	f = 120 Hz, I _O = 500 mA	25°C	54				
Output noise-spectral density	f = 120 Hz	25°C	2			mV/√Hz	
Output noise voltage	10 Hz ≤ f ≤ 100 kHz, CSR = 1 Ω	C _L = 4.7 μF	25°C	95		μV/rms	
		C _L = 10 μF	25°C	89			
		C _L = 100 μF	25°C	74			
V _(TO)	Trip-threshold voltage ($\overline{\text{RESET}}^\S$)	V _{O(FB)} decreasing	–40°C to 125°C	1.101	1.145	V	
V _{hys}	Hysteresis voltage ($\overline{\text{RESET}}^\S$)	Measured at V _{O(ER)}	25°C	12		mV	
V _{OL}	Low-level output voltage ($\overline{\text{RESET}}^\S$)	V _I = 2.13 V, I _{O(RESET)} = 400 μA	25°C	0.1	0.4	V	
			–40°C to 125°C	0.4			
I _I	Input current (1FB)		25°C	–10	0.1	10	nA
			–40°C to 125°C	–20		20	

[†] CSR (compensation series resistance) refers to the total series resistance, including the equivalent series resistance (ESR) of the capacitor, any series resistance added externally, and PWB trace resistance to C_L.

[‡] Pulse-testing techniques are used to maintain virtual junction temperature as close as possible to ambient temperature; thermal effects must be taken into account separately.

[§] Output voltage programmed to 2.5 V with closed-loop configuration (see application information)

NOTE 3: To calculate dropout voltage, use equation:

$$V_{DO} = I_O \times r_{DS(ON)}$$

r_{DS(ON)} is a function of both output current and input voltage. This parametric table lists r_{DS(ON)} for V_I = 3.9 V and 5.9 V, which corresponds to dropout conditions for programmed output voltages of 4 V and 6 V respectively. For other programmed values, refer to Figure 29.

TPS73HD301, TPS73HD318, TPS73HD325 DUAL-OUTPUT LOW-DROPOUT VOLTAGE REGULATORS

SLVS167C – SEPTEMBER 1998 – REVISED – MAY 1999

electrical characteristics, $V_{I(IN)} = 4.3\text{ V}$, $I_O = 10\text{ mA}$, $\overline{EN} = 0\text{ V}$, $C_O = 4.7\text{ }\mu\text{F}/\text{CSRT} = 1\text{ }\Omega$, SENSE/FB shorted to OUT (unless otherwise noted) (continued)

1.8-V regulator (TPS73HD318)

PARAMETER		TEST CONDITIONS†	T _J	MIN	TYP	MAX	UNIT
V _O	Output voltage	4.3 V ≤ V _I ≤ 10 V	25°C	1.746	1.8	1.854	V
			–40°C to 125°C	1.728		1.872	
	Pass-element series resistance	(3.5 V – V _O)/I _O , I _O = 750 mA, V _I = 3.5 V, V _{2SENSE} = 0 V‡	25°C		0.5	1	Ω
			–40°C to 125°C			1.2	
	Input regulation	50 μA ≤ I _O ≤ 750 mA, See NOTE 2	25°C		6		mV
	Output regulation	I _O = 5 mA to 750 mA, See NOTE 2	25°C		14		mV
		I _O = 50 μA to 750 mA, See NOTE 2	25°C		18		
	Ripple rejection	f = 120 Hz, I _O = 50 μA	25°C		51		dB
		f = 120 Hz, I _O = 500 mA	25°C		49		
	Output noise-spectral density	f = 120 Hz	25°C		2		mV/√Hz
	Output noise voltage	10 Hz ≤ f ≤ 100 kHz, CSR = 1 Ω	C _L = 4.7 μF	25°C		274	μV/rms
			C _L = 10 μF	25°C		228	
			C _L = 100 μF	25°C		159	

† CSR (compensation series resistance) refers to the total series resistance, including the equivalent series resistance (ESR) of the capacitor, any series resistance added externally, and PWB trace resistance to C_L.

‡ Pulse-testing techniques are used to maintain virtual junction temperature as close as possible to ambient temperature; thermal effects must be taken into account separately.

§ Pass-element series resistance measured with sense pin disconnected from output to allow output voltage to rise to full saturation.

TPS73HD301, TPS73HD318, TPS73HD325 DUAL-OUTPUT LOW-DROPOUT VOLTAGE REGULATORS

SLVS167C – SEPTEMBER 1998 – REVISED – MAY 1999

electrical characteristics, $V_{I(IN)} = 4.3\text{ V}$, $I_O = 10\text{ mA}$, $\overline{EN} = 0\text{ V}$, $C_O = 4.7\text{ }\mu\text{F/CSR}^\dagger = 1\text{ }\Omega$, SENSE/FB shorted to OUT (unless otherwise noted) (continued)

2.5-V regulator (TPS73HD325)

PARAMETER		TEST CONDITIONS [‡]	T _J	MIN	TYP	MAX	UNIT
V _O	Output voltage	4.3 V ≤ V _I ≤ 10 V	25°C	2.45	2.5	2.55	V
			–40°C to 125°C	2.425		2.575	
	Dropout voltage	I _O = 750 mA, V _I = 3.5 V	–40°C to 125°C			800	mV
	Input regulation	50 μA ≤ I _O ≤ 750 mA, See NOTE 2	25°C		6		mV
	Output regulation	I _O = 5 mA to 750 mA, See NOTE 2	25°C		20		mV
		I _O = 50 μA to 750 mA, See NOTE 2	25°C		25		mV
	Ripple rejection	f = 120 Hz, I _O = 50 μA	25°C		51		dB
		f = 120 Hz, I _O = 500 mA	25°C		49		
	Output noise-spectral density	f = 120 Hz	25°C		2		mV/√Hz
	Output noise voltage	10 Hz ≤ f ≤ 100 kHz, CSR = 1 Ω	C _L = 4.7 μF	25°C		274	μV/rms
			C _L = 10 μF	25°C		228	
			C _L = 100 μF	25°C		159	
V _(TO)	Trip-threshold voltage (RESET)	V _O decreasing	–40°C to 125°C	2.172			V
V _{hys}	Hysteresis voltage (RESET)		25°C		18		mV
V _{OL}	Low-level output voltage (RESET)	V _I = 2.8 V, I _O (RESET) = –1 mA	25°C		0.17	0.4	V
			–40°C to 125°C			0.4	

[†] CSR (compensation series resistance) refers to the total series resistance, including the equivalent series resistance (ESR) of the capacitor, any series resistance added externally, and PWB trace resistance to C_L.

[‡] Pulse-testing techniques are used to maintain virtual junction temperature as close as possible to ambient temperature; thermal effects must be taken into account separately.

[§] Pass-element series resistance measured with sense pin disconnected from output to allow output voltage to rise to full saturation.

switching characteristics

PARAMETER	TEST CONDITIONS	T _J	MIN	TYP	MAX	UNIT
Time-out delay (RESET)	See Figure 3	25°C	140	200	260	ms
		–40°C to 125°C	100		300	

TPS73HD301, TPS73HD318, TPS73HD325 DUAL-OUTPUT LOW-DROPOUT VOLTAGE REGULATORS

SLVS167C – SEPTEMBER 1998 – REVISED – MAY 1999

electrical characteristics, $V_{I(IN)} = 4.3\text{ V}$, $I_O = 10\text{ mA}$, $\overline{EN} = 0\text{ V}$, $C_O = 4.7\text{ }\mu\text{F}/\text{CSR}^\dagger = 1\text{ }\Omega$, SENSE/FB shorted to OUT (unless otherwise noted) (continued)

3.3-V regulator (TPS73HD301)

PARAMETER	TEST CONDITIONS [‡]	T _J	MIN	TYP	MAX	UNIT
V _O Output voltage	4.3 V ≤ V _I ≤ 10 V	25°C		3.3		V
		–40°C to 125°C	3.23		3.37	
Dropout voltage	I _O = 10 mA, V _I = 3.23 V	25°C		4.5	10	mV
		25°C		44	100	
	I _O = 100 mA, V _I = 3.23 V	25°C		353	750	
		–40°C to 125°C			800	
Pass-element series resistance	(3.23 V – V _O)/I _O , V _I = 3.23 V, I _O = 750 mA	25°C		0.44	1	Ω
		–40°C to 125°C			1.07	
Input regulation	50 μA ≤ I _O ≤ 750 mA, See NOTE 2	25°C		6		mV
Output regulation	I _O = 5 mA to 750 mA, See NOTE 2	25°C		30		mV
	I _O = 50 μA to 750 mA, See NOTE 2	25°C		37		mV
Ripple rejection	f = 120 Hz, I _O = 50 μA	25°C		51		dB
	f = 120 Hz, I _O = 500 mA	25°C		49		
Output noise-spectral density	f = 120 Hz	25°C		2		mV/√Hz
Output noise voltage	10 Hz ≤ f ≤ 100 kHz, CSR = 1 Ω	C _L = 4.7 μF	25°C		274	μV/rms
		C _L = 10 μF	25°C		228	
		C _L = 100 μF	25°C		159	
V _(TO) Trip-threshold voltage (RESET)	V _O decreasing	–40°C to 125°C	2.868			V
V _{hys} Hysteresis voltage (RESET)		25°C		18		mV
V _{OL} Low-level output voltage (RESET)	V _I = 2.8 V, I _O (RESET) = –1 mA	25°C		0.17	0.4	V
		–40°C to 125°C			0.4	

[†] CSR (compensation series resistance) refers to the total series resistance, including the equivalent series resistance (ESR) of the capacitor, any series resistance added externally, and PWB trace resistance to C_L.

[‡] Pulse-testing techniques are used to maintain virtual junction temperature as close as possible to ambient temperature; thermal effects must be taken into account separately.

switching characteristics

PARAMETER	TEST CONDITIONS	T _J	MIN	TYP	MAX	UNIT
Time-out delay (RESET)	See Figure 3	25°C	140	200	260	ms
		–40°C to 125°C	100		300	

PARAMETER MEASUREMENT INFORMATION

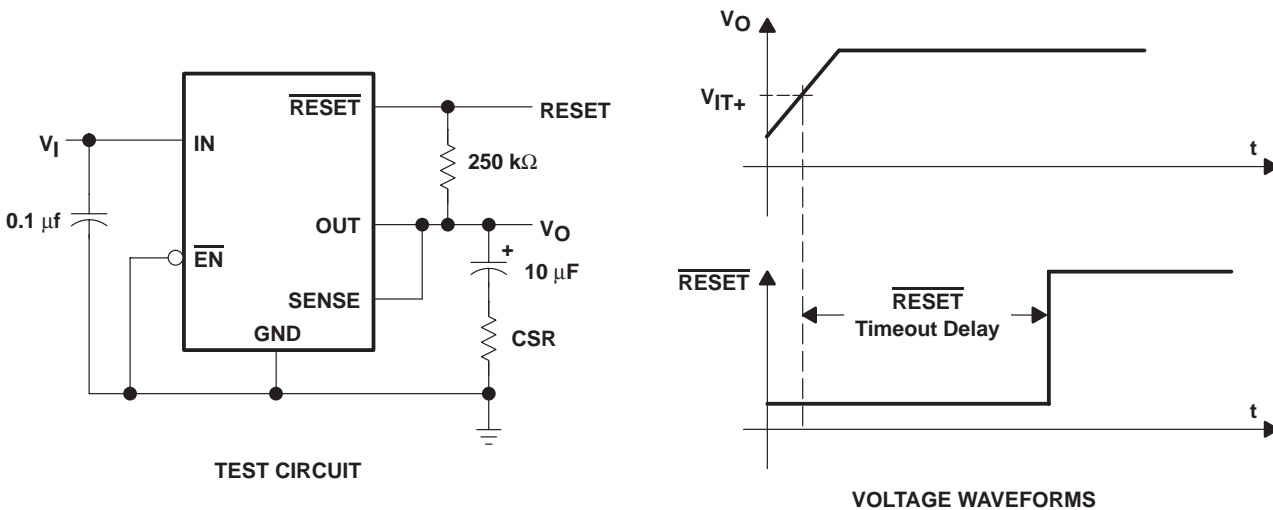

Figure 1. Test Circuit and Voltage Waveforms

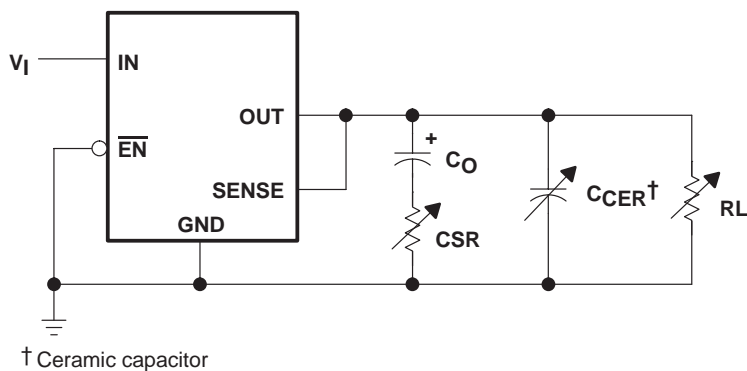

Figure 2. Test Circuit for Typical Regions of Stability (Refer to Figures 29 through 32)

TPS73HD301, TPS73HD318, TPS73HD325 DUAL-OUTPUT LOW-DROPOUT VOLTAGE REGULATORS

SLVS167C – SEPTEMBER 1998 – REVISED – MAY 1999

TYPICAL CHARACTERISTICS

Table of Graphs

I_Q	Quiescent current		vs Load current	5
			vs Input voltage	6
V_{DO}	Dropout voltage	Adjustable regulator	vs Load current	7
		3.3-V regulator	vs Load current	8
ΔV_{DO}	Change in dropout voltage		vs Free-air temperature	9
V_{DO}	Dropout voltage		vs Output current	10
ΔV_O	Change in output voltage		vs Free-air temperature	11
V_O	Output voltage		vs Input voltage	12
	Line regulation			13
V_O	Output voltage		vs Output current	14, 15
	Output voltage response from enable (\overline{EN})			16
	Load transient response	Adjustable regulator		17
		3.3-V regulator		18
	Line transient response	Adjustable regulator		19
		3.3-V regulator		20
	Ripple rejection		vs Frequency	21
	Output spectral noise density		vs Frequency	22
	Compensation series resistance (CSR)	Adjustable regulator	vs Output current	23
			vs Added ceramic capacitance	24
			vs Output current	25
		3.3-V regulator	vs Output current	26
		Adjustable regulator	vs Added ceramic capacitance	27
		3.3-V regulator	vs Added ceramic capacitance	28
$r_{DS(on)}$	Pass-element resistance		vs Input voltage	29
V_I	Minimum input voltage for valid \overline{RESET}		vs Free-air temperature	30
V_{IT-}	Negative-going reset threshold		vs Free-air temperature	31
$I_{OL(RESET)}$	\overline{RESET} output current	3.3-V regulator	vs Input voltage	32
t_d	Reset time delay		vs Free-air temperature	33
t_d	Distribution for reset delay			34



TYPICAL CHARACTERISTICS

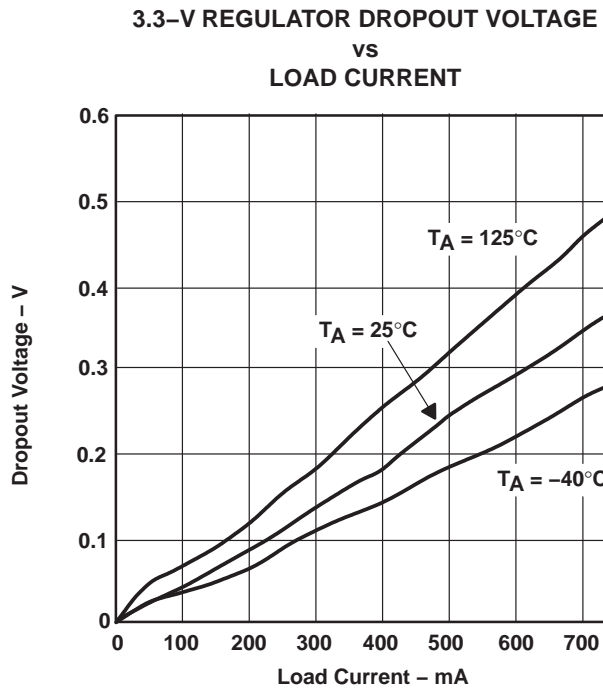
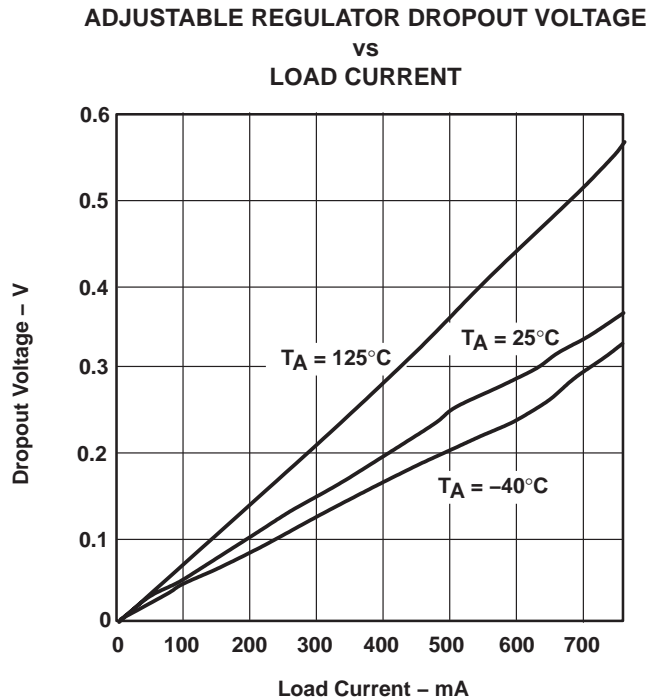
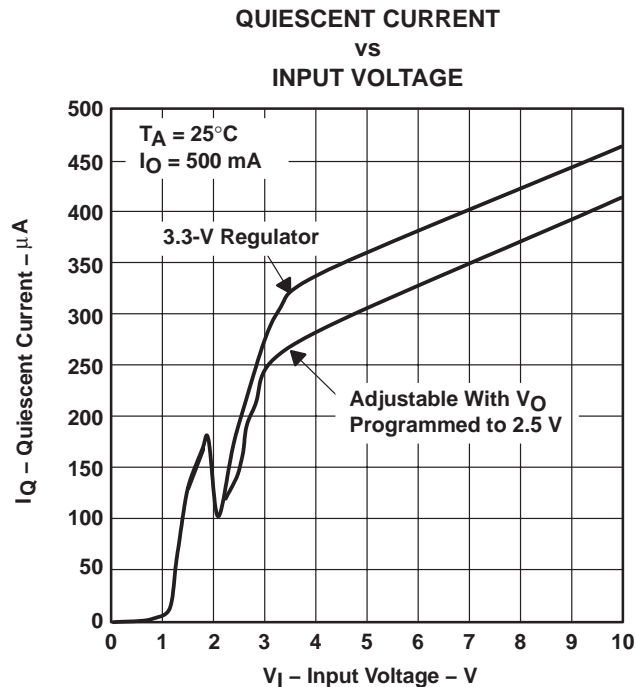
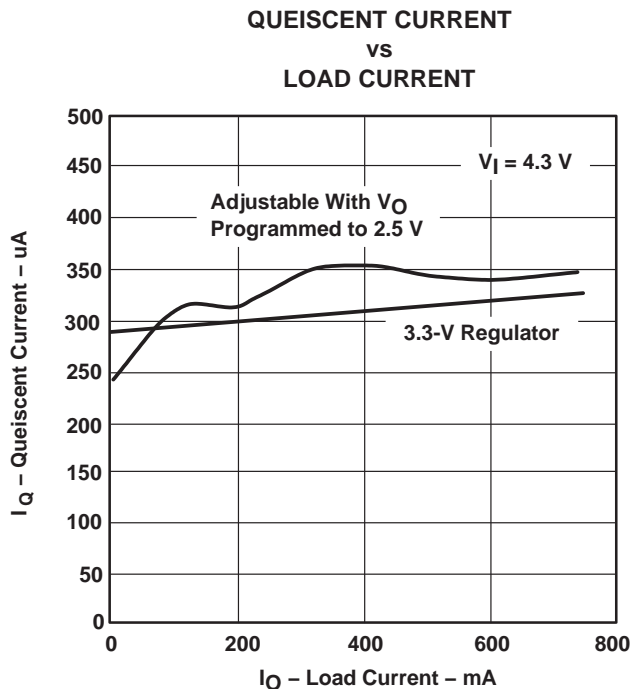

TPS73HD301, TPS73HD318, TPS73HD325 DUAL-OUTPUT LOW-DROPOUT VOLTAGE REGULATORS

SLVS167C – SEPTEMBER 1998 – REVISED – MAY 1999

TYPICAL CHARACTERISTICS

CHANGE IN DROPOUT VOLTAGE
vs
FREE-AIR TEMPERATURE

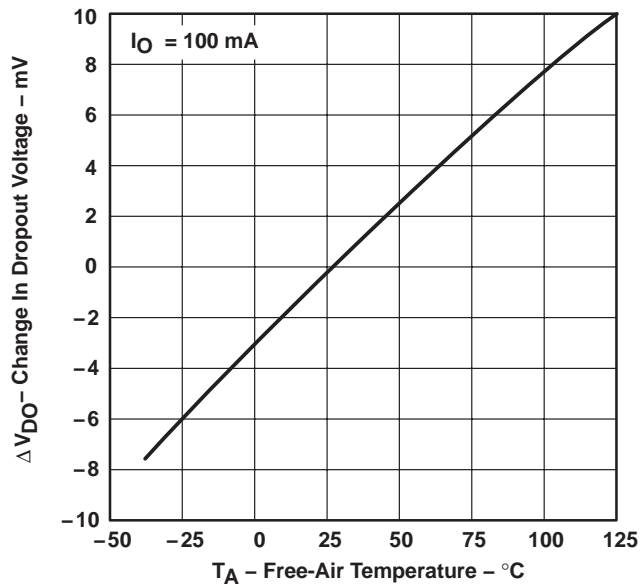

Figure 7

DROPOUT VOLTAGE
vs
OUTPUT CURRENT

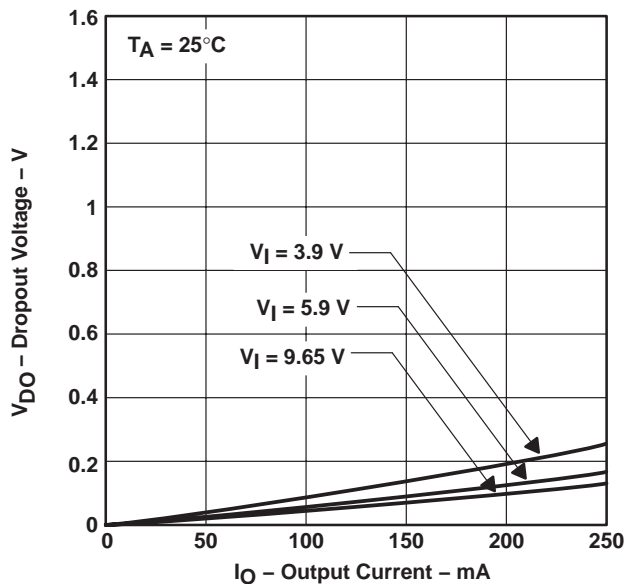

Figure 8

CHANGE IN OUTPUT VOLTAGE
vs
FREE-AIR TEMPERATURE

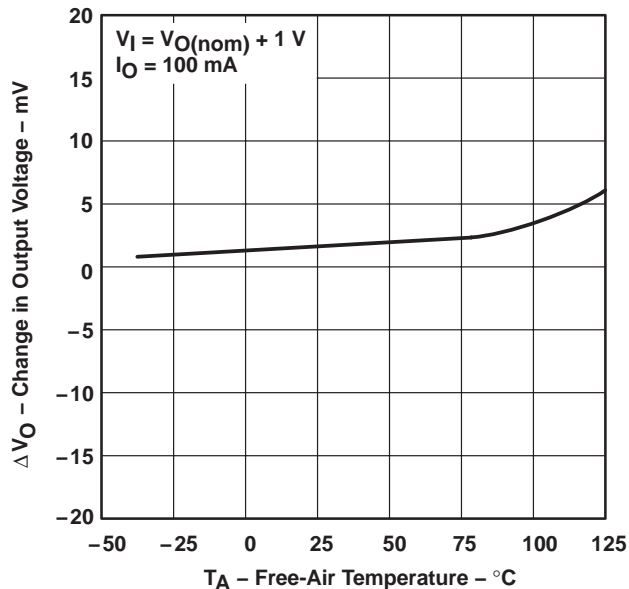

Figure 9

OUTPUT VOLTAGE
vs
INPUT VOLTAGE

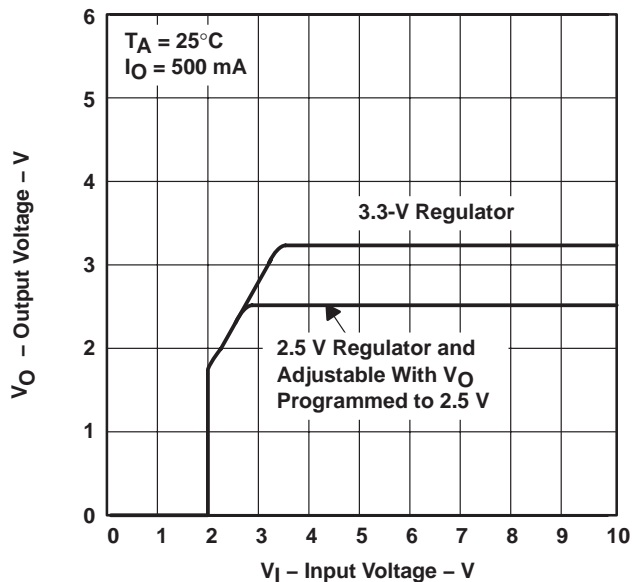

Figure 10



TYPICAL CHARACTERISTICS

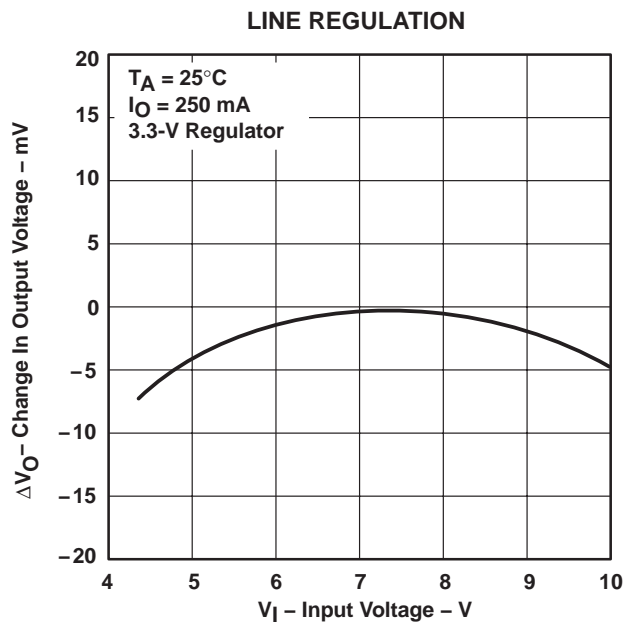

Figure 11

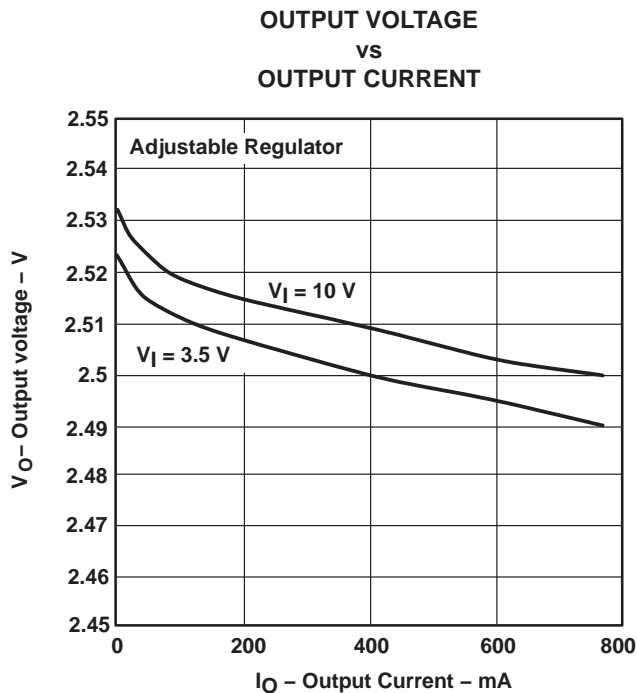

Figure 12

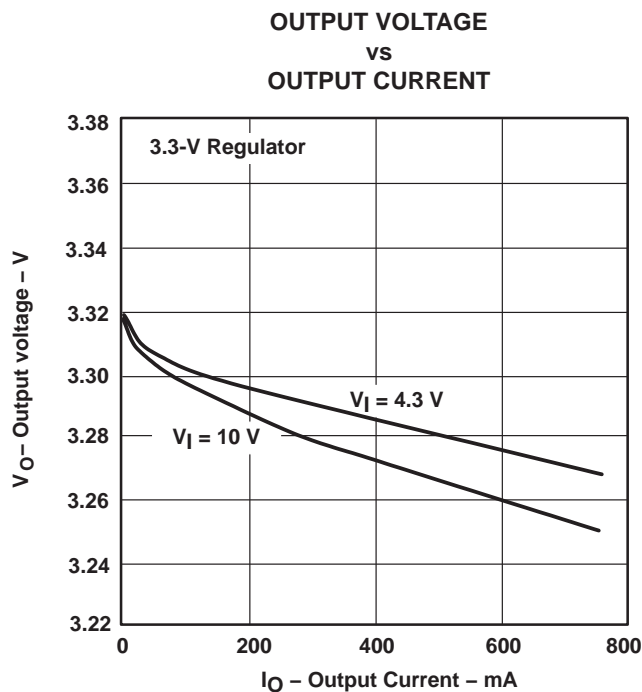

Figure 13

TPS73HD301, TPS73HD318, TPS73HD325 DUAL-OUTPUT LOW-DROPOUT VOLTAGE REGULATORS

SLVS167C – SEPTEMBER 1998 – REVISED – MAY 1999

TYPICAL CHARACTERISTICS

OUTPUT VOLTAGE RESPONSE FROM ENABLE (\overline{EN})

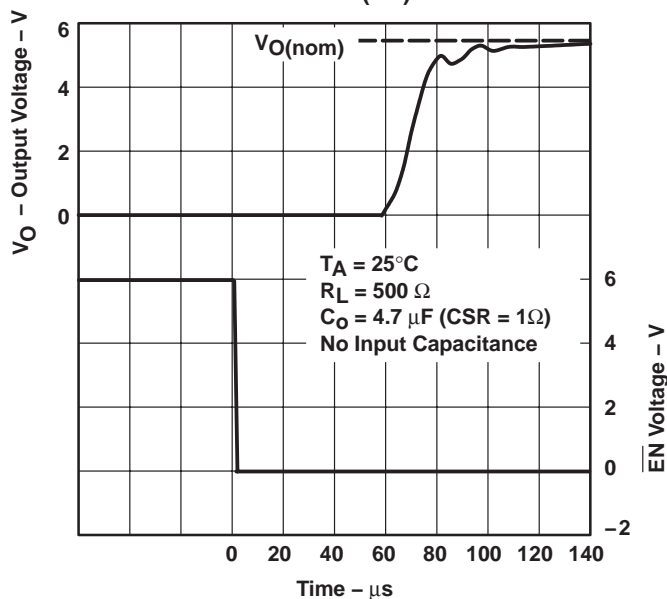

Figure 14

ADJUSTABLE REGULATOR LOAD TRANSIENT RESPONSE

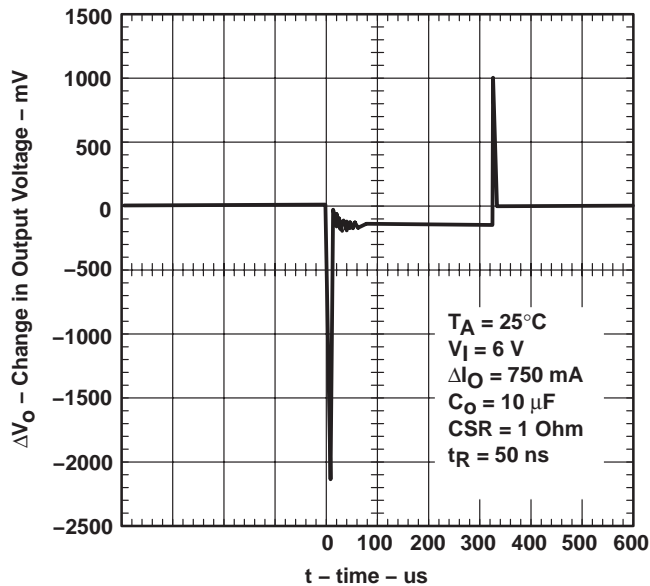

Figure 15

3.3-V REGULATOR LOAD TRANSIENT RESPONSE

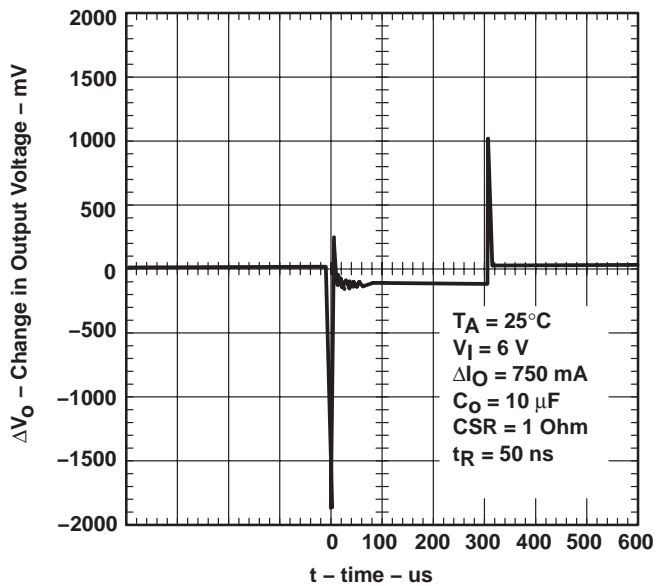

Figure 16



TYPICAL CHARACTERISTICS

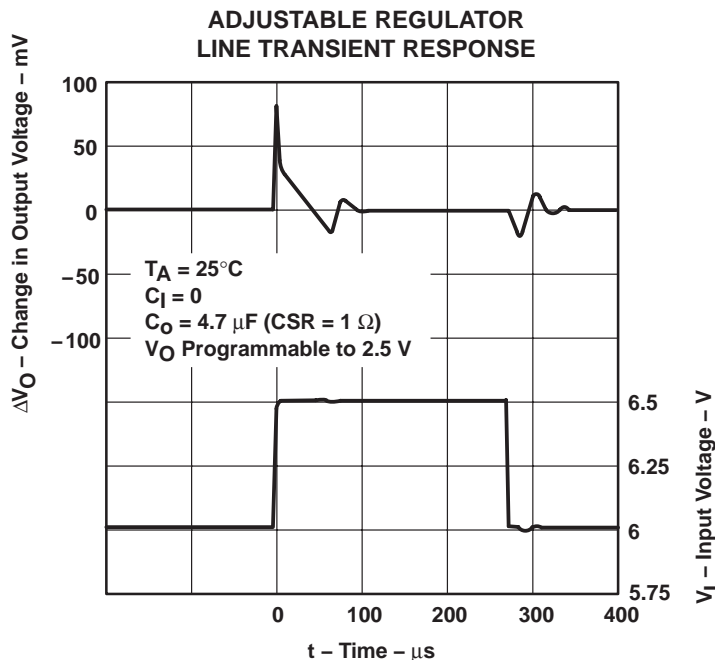

Figure 17

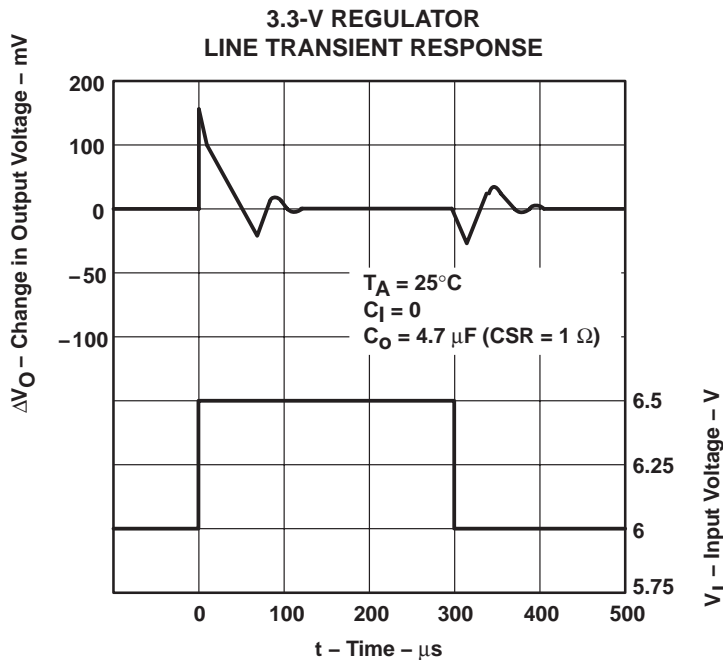

Figure 18

TPS73HD301, TPS73HD318, TPS73HD325 DUAL-OUTPUT LOW-DROPOUT VOLTAGE REGULATORS

SLVS167C – SEPTEMBER 1998 – REVISED – MAY 1999

TYPICAL CHARACTERISTICS

**RIPPLE REJECTION
VS
FREQUENCY**

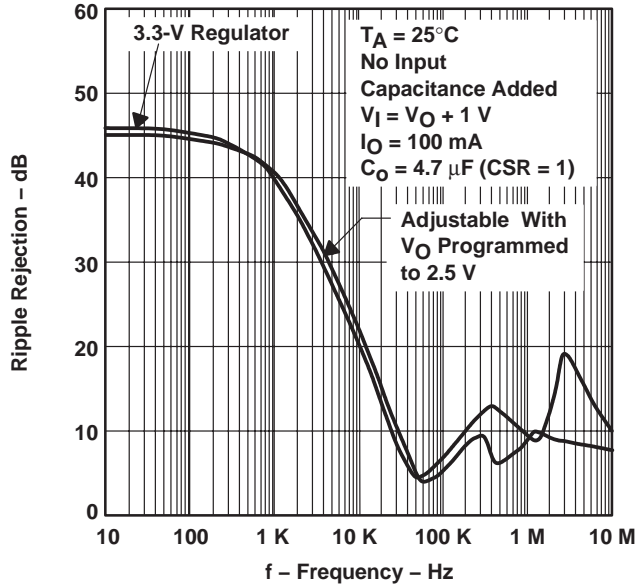

Figure 19

**OUTPUT SPECTRAL-NOISE DENSITY
VS
FREQUENCY**

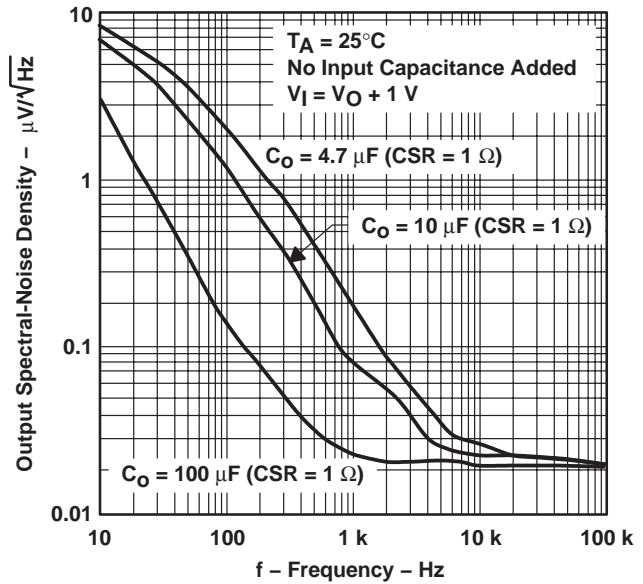

Figure 20

**TYPICAL REGIONS OF STABILITY
COMPENSATION SERIES RESISTANCE (CSR)[†]
VS
OUTPUT CURRENT**

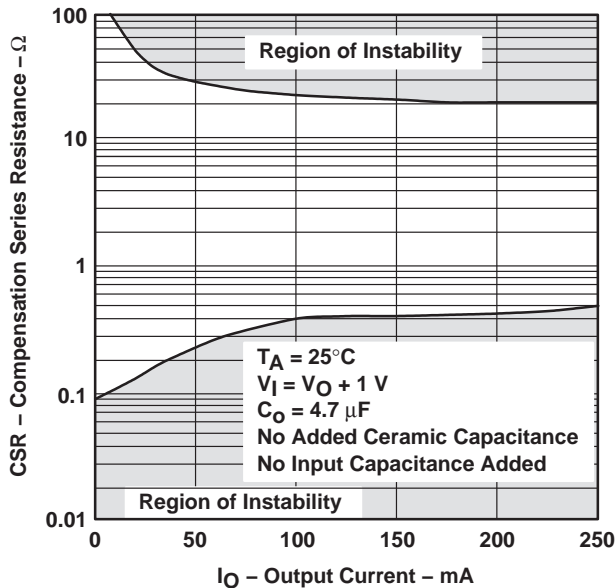

Figure 21

**TYPICAL REGIONS OF STABILITY
COMPENSATION SERIES RESISTANCE (CSR)[†]
VS
ADDED CERAMIC CAPACITANCE**

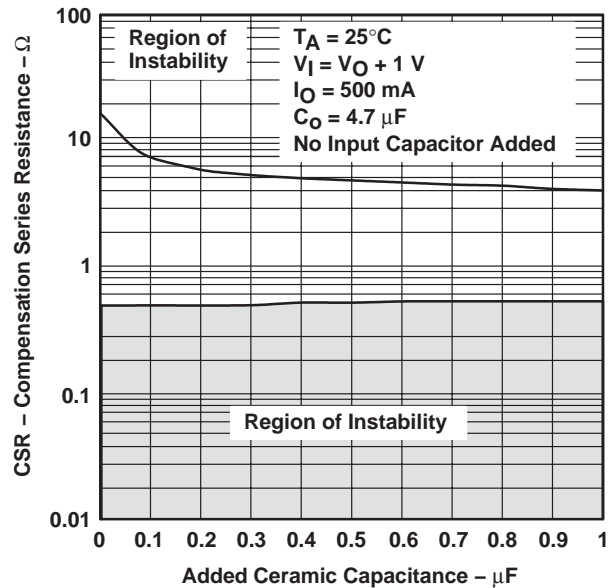

Figure 22



TYPICAL CHARACTERISTICS

ADJUSTABLE REGULATOR TYPICAL REGIONS OF STABILITY
 COMPENSATION SERIES RESISTANCE

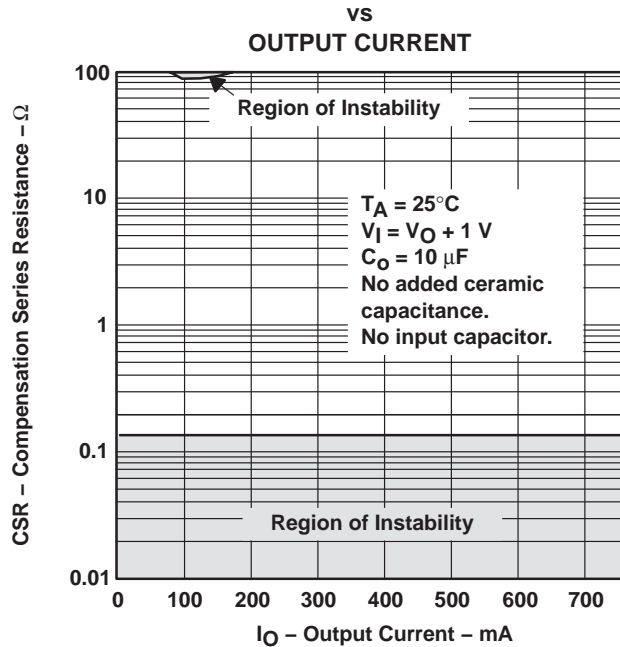

Figure 23

3.3-V REGULATOR TYPICAL REGIONS OF STABILITY
 COMPENSATION SERIES RESISTANCE

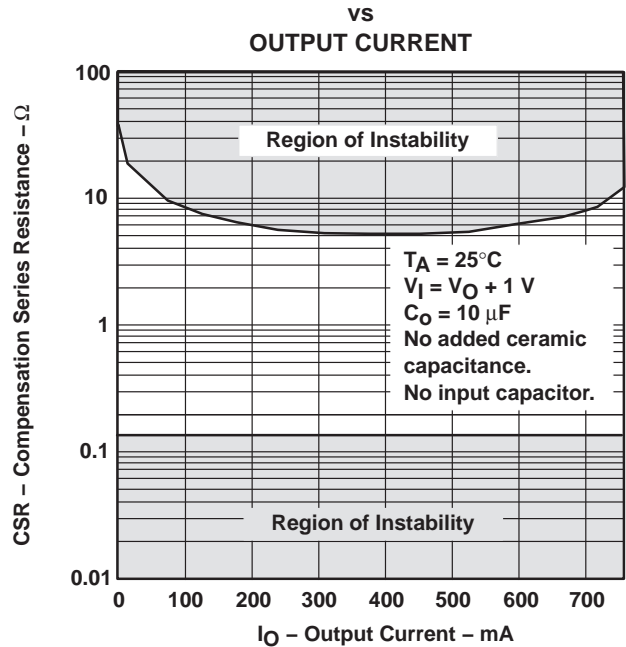

Figure 24

ADJUSTABLE REGULATOR TYPICAL REGIONS OF STABILITY
 COMPENSATION SERIES RESISTANCE

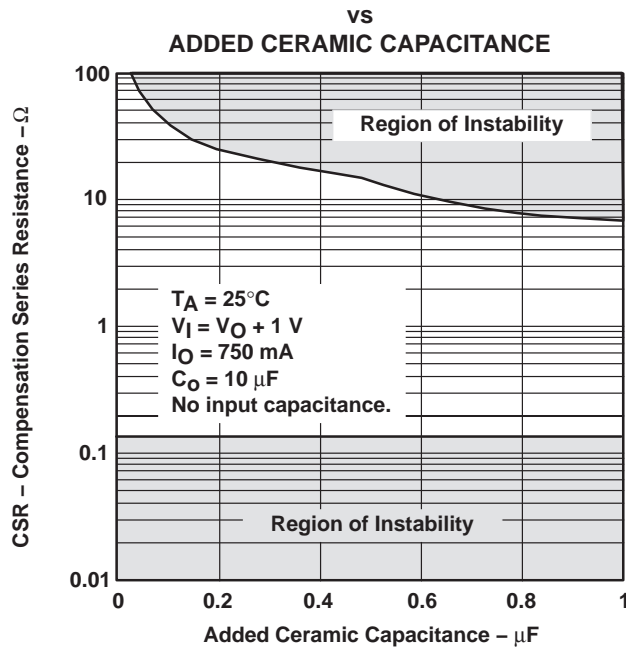

Figure 25

3.3-V REGULATOR TYPICAL REGIONS OF STABILITY
 COMPENSATION SERIES RESISTANCE

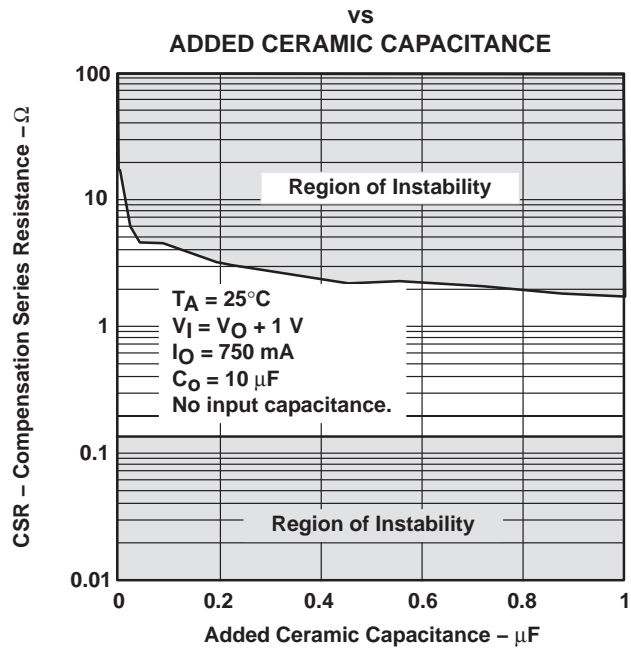
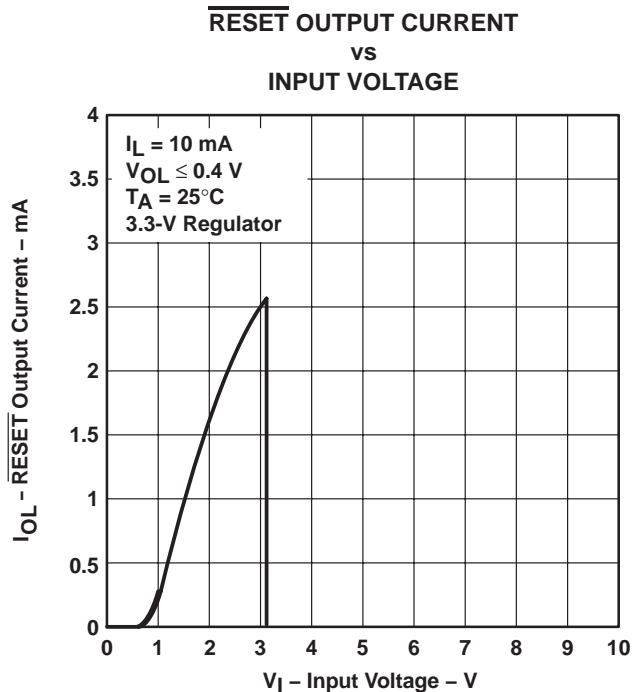
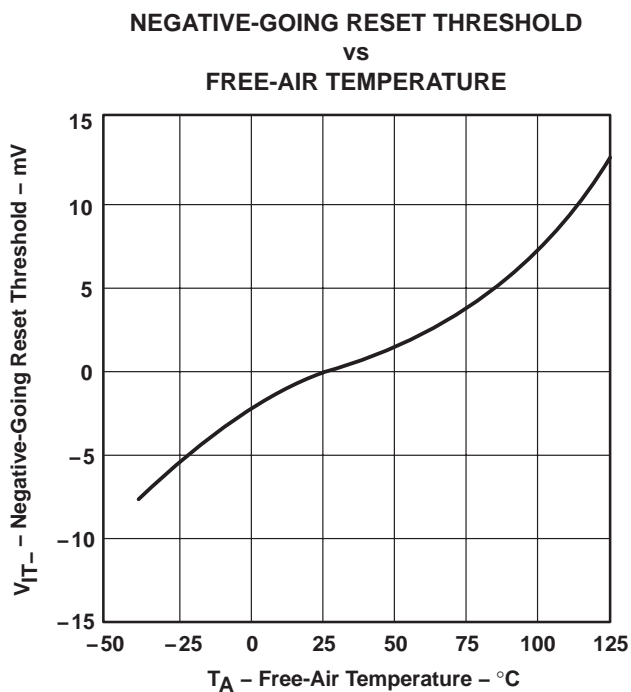
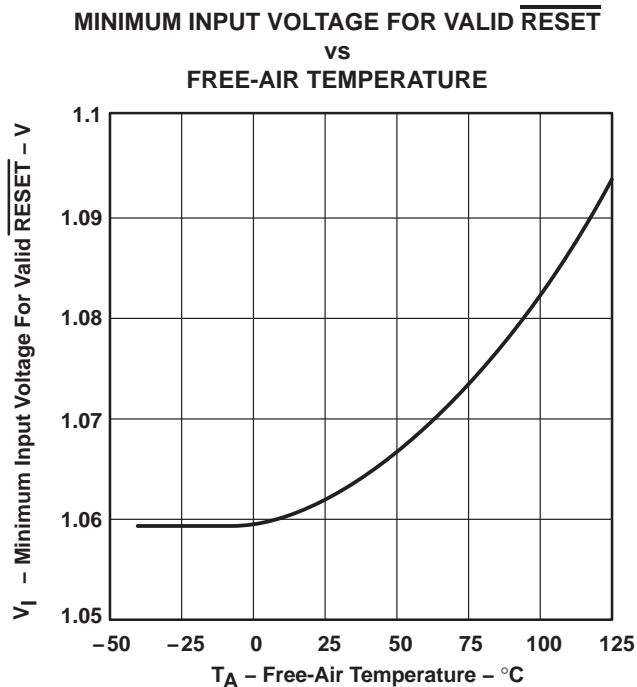
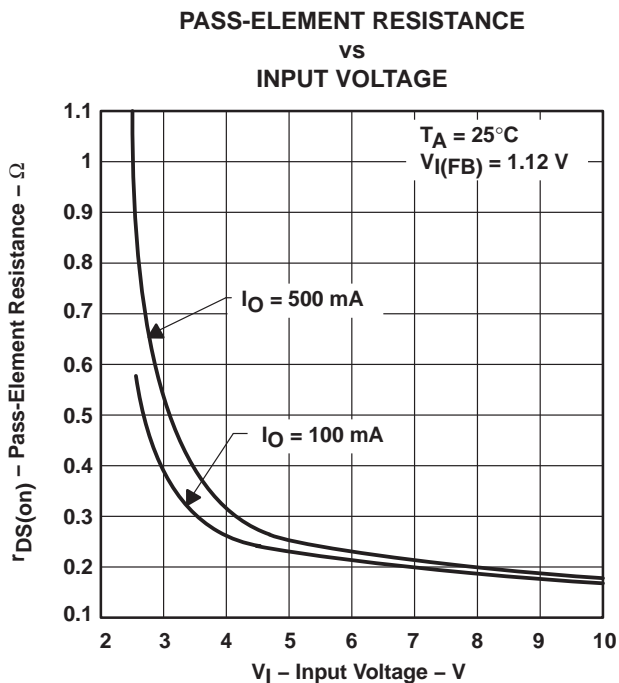

Figure 26

TPS73HD301, TPS73HD318, TPS73HD325 DUAL-OUTPUT LOW-DROPOUT VOLTAGE REGULATORS

SLVS167C – SEPTEMBER 1998 – REVISED – MAY 1999

TYPICAL CHARACTERISTICS



TYPICAL CHARACTERISTICS

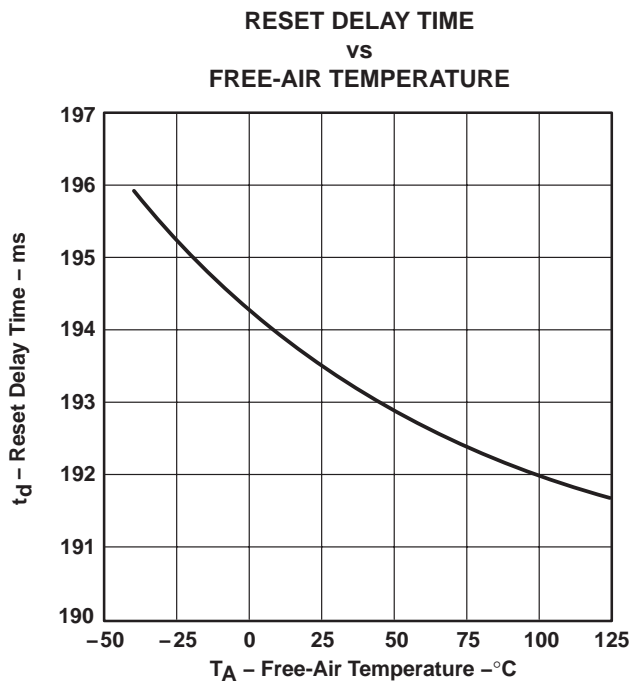

Figure 31

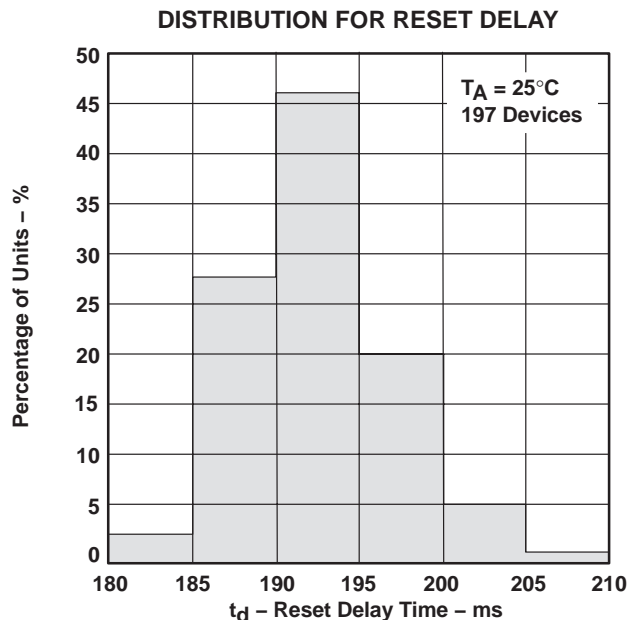

Figure 32

THERMAL INFORMATION

The TPS73HD3xx is packaged in a high-power dissipation downset lead frame for optimal power handling. with proper heat dissipation techniques, the full power soutput of these devices can be safely handled over the full temperture range. The Texas Instruments technical brief, *PowerPAD Thermally Enhanced Package* (literature number SLMA002), goes into considerable detail into techniques for properly mounting this type of package for maximum thermal performance. A thermal conduction plane of approximately 3" y 3" will give a power dissipatio level of 4.5 W.

Power dissipation within the device can be calculated with the following equation:

$$P_D = P_{IN} - P_{OUT} = V_I(I_{O1} + I_{O2}) - (V_{O1} \times I_{O1} + V_{O2} \times I_{O2})$$

TPS73HD301, TPS73HD318, TPS73HD325 DUAL-OUTPUT LOW-DROPOUT VOLTAGE REGULATORS

SLVS167C – SEPTEMBER 1998 – REVISED – MAY 1999

APPLICATION INFORMATION

thermal considerations

DISSIPATION RATING TABLE

PACKAGE	AIR FLOW (CFM)	T _A < 25°C POWER RATING	DERATING FACTOR ABOVE T _A = 25°C	T _A = 70°C POWER RATING	T _A = 85°C POWER RATING
PWP†	0	2.9 W	23.5 mW/°C	1.9 W	1.5 W
	300	4.3 W	34.6 mW/°C	2.8 W	2.2 W
PWP‡	0	3 W	23.8 mW/°C	1.9 W	1.5 W
	300	7.2 W	57.9 mW/°C	4.6 W	3.8 W

† This parameter is measured with the recommended copper heat sink pattern on a 1-layer PCB, 5-in × 5-in PCB, 1 oz. copper, 2-in × 2-in coverage (4 in²).

‡ This parameter is measured with the recommended copper heat sink pattern on an 8-layer PCB, 1.5-in × 2-in PCB, 1 oz. copper with layers 1, 2, 4, 5, 7, and 8 at 5% coverage (0.9 in²) and layers 3 and 6 at 100% coverage (6 in²).

The maximum ambient temperature depends on the heatsinking ability of the PCB system. Using the 0 CFM and 300 CFM data from the dissipation rating table, the derating factor for the PWP package with 6.9 in² of copper area on a multilayer PCB is 24 mW/°C and 58 mW/°C respectively. Converting this to Θ_{JA} :

$$\Theta_{JA} = \frac{1}{\text{Derating}}$$

For 0 CFM :

$$= \frac{1}{0.0235}$$

$$= 42.6^{\circ}\text{C/W}$$

For 300 CFM :

$$= \frac{1}{0.0579}$$

$$= 17.3^{\circ}\text{C/W}$$

Given Θ_{JA} , the maximum allowable junction temperature, and the total internal dissipation, the maximum ambient temperature can be calculated with the following equation. The maximum recommended junction temperature for the TPS73HD3xx is 150 °C.

$$T_{A \text{ Max}} = T_{J \text{ Max}} - (\Theta_{JA} \times P_D)$$

The maximum power dissipation limit is determined using the following equation:

$$T_{D(\text{max})} = \frac{T_{J \text{ max}} - T_A}{R_{\Theta JA}}$$

Where:

T_{Jmax} is the maximum allowable junction temperature

R_{θJA} is the thermal resistance junction-to-free-air for the package (i.e., 285°C/W for the 5-terminal SOT-23 package).

T_A is the free-air temperature

The regulator dissipation is calculated using:

$$P_D = (V_I - V_O) \times I_O$$

Power dissipation resulting from quiescent current is negligible.

TPS73HD301, TPS73HD318, TPS73HD325 DUAL-OUTPUT LOW-DROPOUT VOLTAGE REGULATORS

SLVS167C – SEPTEMBER 1998 – REVISED – MAY 1999

APPLICATION INFORMATION

Capitalizing upon the features of the TPS73xx family (low-dropout voltage, low quiescent current, power-saving shutdown mode, and a supply-voltage supervisor) and the power-dissipation properties of the TSSOP PowerPAD package has enabled the integration of the TPS73HD3xx dual LDO regulator with high output current for use in DSP and other multiple voltage applications. Figure 35 shows a typical dual-voltage DSP application.

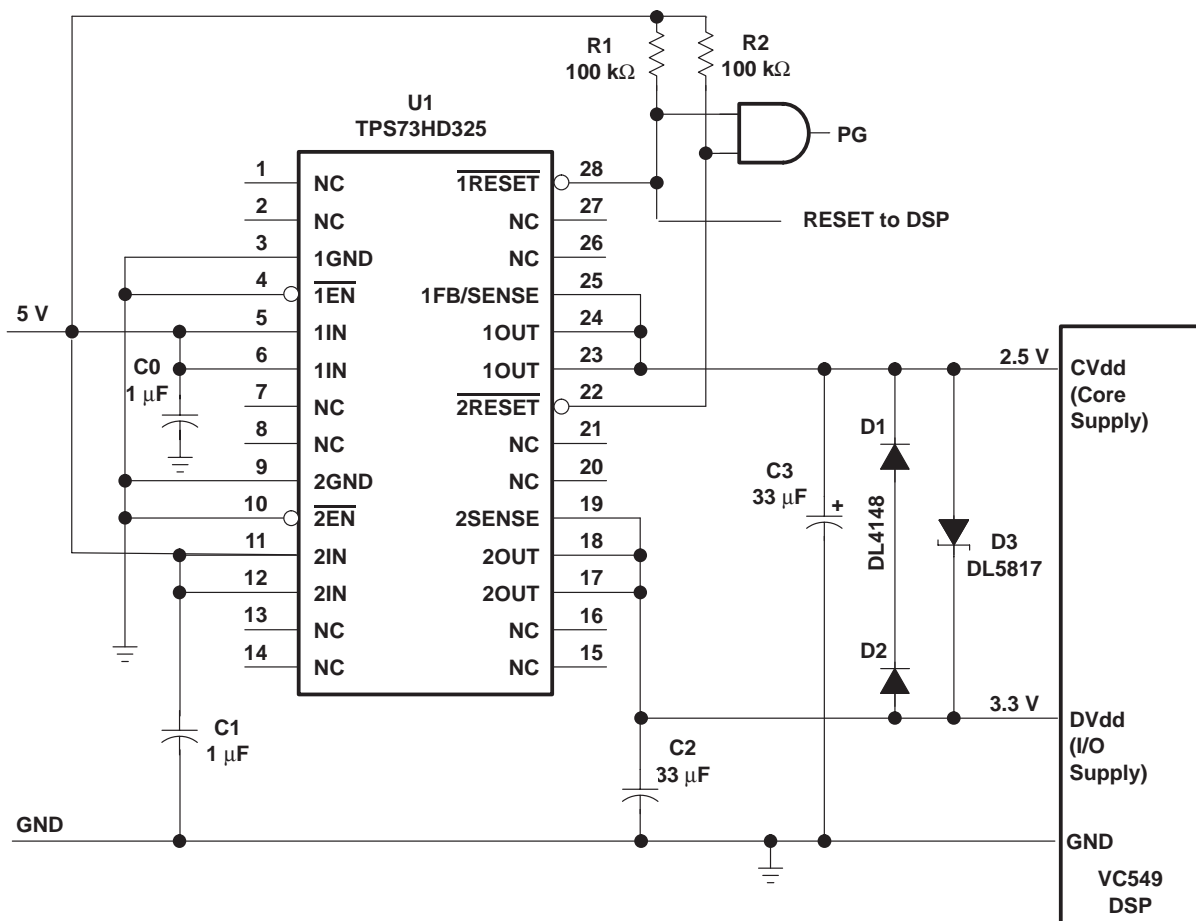

Figure 33. Dual-Voltage DSP Application

DSP power requirements include very high transient currents that must be considered in the initial design. This design uses higher-valued output capacitors to handle the large transient currents. Details of this type of design are shown in the application report, *Designing Power Supplies for TMS320VC549 DSP Systems*.

minimum load requirements

The TPS73HD3xx is stable even at zero load; no minimum load is required for operation.

TPS73HD301, TPS73HD318, TPS73HD325 DUAL-OUTPUT LOW-DROPOUT VOLTAGE REGULATORS

SLVS167C – SEPTEMBER 1998 – REVISED – MAY 1999

APPLICATION INFORMATION

SENSE connection

The SENSE terminal of fixed-output devices must be connected to the regulator output for proper functioning of the regulator. Normally, this connection should be as short as possible; however, the connection can be made near a critical circuit (remote sense) to improve performance at that point. Internally, SENSE connects to a high-impedance wide-bandwidth amplifier through a resistor-divider network, and noise pickup feeds through to the regulator output. It is essential to route the SENSE connection in such a way as to minimize/avoid noise pickup. Adding an RC network between SENSE and OUT to filter noise is not recommended because it can cause the regulator to oscillate.

external capacitor requirements

An input capacitor is not required; however, a ceramic bypass capacitor (0.047 pF to 0.1 μ F) improves load transient response and noise rejection when the TPS73HD3xx is located more than a few inches from the power supply. A higher-capacitance electrolytic capacitor may be necessary if large (hundreds of milliamps) load transients with fast rise times are anticipated.

As with most LDO regulators, the TPS73HD3xx requires an output capacitor for stability. A low-ESR 10- μ F solid-tantalum capacitor connected from the regulator output to ground is sufficient to ensure stability over the full load range (see Figure 44). Adding high-frequency ceramic or film capacitors (such as power-supply bypass capacitors for digital or analog ICs) can cause the regulator to become unstable unless the ESR of the tantalum capacitor is less than 1.2 Ω over temperature. Capacitors with published ESR specifications such as the AVX TPSD106M035R0300 and the Sprague 593D106X0035D2W work well because the maximum ESR at 25°C is 300 m Ω (typically, the ESR in solid-tantalum capacitors increases by a factor of 2 or less when the temperature drops from 25°C to -40°C). Where component height and/or mounting area is a problem, physically smaller, 10- μ F devices can be screened for ESR. Figures 23 through 28 show the stable regions of operation using different values of output capacitance with various values of ceramic load capacitance.

Due to the reduced stability range available when using output capacitors smaller than 10 μ F, capacitors in this range are not recommended. Larger capacitors provide a wider range of stability and better load transient response. Because capacitor minimum ESR is seldom if ever specified, it may be necessary to add a 0.5- Ω to 1- Ω resistor in series with the capacitor and limit ESR to 1.5 Ω maximum. As shown in the CSR graphs (Figures 23 through 28), minimum ESR is not a problem when using 10- μ F or larger output capacitors.

Below is a partial listing of surface-mount capacitors usable with the TPS73HD3xx. This information, along with the CSR graphs, is included to assist in selection of suitable capacitance for the user's application. When necessary to achieve low height requirements along with high output current and/or high ceramic load capacitance, several higher ESR capacitors can be used in parallel to meet the guidelines above.

TPS73HD301, TPS73HD318, TPS73HD325 DUAL-OUTPUT LOW-DROPOUT VOLTAGE REGULATORS

SLVS167C – SEPTEMBER 1998 – REVISED – MAY 1999

APPLICATION INFORMATION

external capacitor requirements (continued)

All load and temperature conditions with up to 1 μF of added ceramic load capacitance:

PART NO.	MFR.	VALUE	MAX ESR†	SIZE (H × L × W)†
T421C226M010AS	Kemet	22 μF , 10 V	0.5	2.8 × 6 × 3.2
593D156X0025D2W	Sprague	15 μF , 25 V	0.3	2.8 × 7.3 × 4.3
593D106X0035D2W	Sprague	10 μF , 35 V	0.3	2.8 × 7.3 × 4.3
TPSD106M035R0300	AVX	10 μF , 35 V	0.3	2.8 × 7.3 × 4.3

Load < 200 mA, ceramic load capacitance < 0.2 μF , full temperature range:

PART NO.	MFR.	VALUE	MAX ESR†	SIZE (H × L × W)†
592D156X0020R2T	Sprague	15 μF , 20 V	1.1	1.2 × 7.2 × 6
595D156X0025C2T	Sprague	15 μF , 25 V	1	2.5 × 7.1 × 3.2
595D106X0025C2T	Sprague	10 μF , 25 V	1.2	2.5 × 7.1 × 3.2
293D226X0016D2W	Sprague	22 μF , 16 V	1.1	2.8 × 7.3 × 4.3

Load < 100 mA, ceramic load capacitance < 0.2 μF , full temperature range:

PART NO.	MFR.	VALUE	MAX ESR†	SIZE (H × L × W)†
195D106X06R3V2T	Sprague	10 μF , 6.3 V	1.5	1.3 × 3.5 × 2.7
195D106X0016X2T	Sprague	10 μF , 16 V	1.5	1.3 × 7 × 2.7
595D156X0016B2T	Sprague	15 μF , 16 V	1.8	1.6 × 3.8 × 2.6
695D226X0015F2T	Sprague	22 μF , 15 V	1.4	1.8 × 6.5 × 3.4
695D156X0020F2T	Sprague	15 μF , 20 V	1.5	1.8 × 6.5 × 3.4
695D106X0035G2T	Sprague	10 μF , 35 V	1.3	2.5 × 7.6 × 2.5

† Size is in mm. ESR is maximum resistance at 100 kHz and $T_A = 25^\circ\text{C}$. Listings are sorted by height.

TPS73HD301, TPS73HD318, TPS73HD325 DUAL-OUTPUT LOW-DROPOUT VOLTAGE REGULATORS

SLVS167C – SEPTEMBER 1998 – REVISED – MAY 1999

APPLICATION INFORMATION

programming the adjustable LDO regulator output

Programming the adjustable regulator is done using an external resistor divider as shown in Figure 44. The equation governing the output voltage is:

$$V_O = V_{ref} \times \left(1 + \frac{R1}{R2}\right)$$

Where

V_{ref} = reference voltage, 1.182 V typ

Resistors R1 and R2 should be chosen for approximately 7- μ A divider current. A recommended value for R2 is 169 k Ω with R1 adjusted for the desired output voltage. Smaller resistors can be used, but offer no inherent advantage and consume more power. Larger values of R1 and R2 should be avoided as leakage currents at FB will introduce an error. Solving for R1 yields a more useful equation for choosing the appropriate resistance:

$$R1 = \left(\frac{V_O}{V_{ref}} - 1\right) \times R2$$

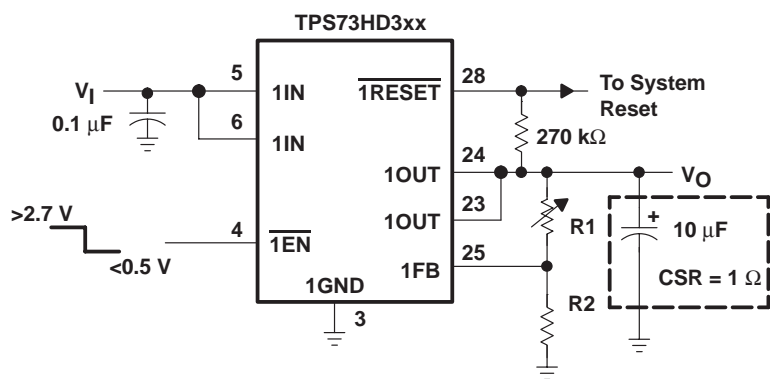

OUTPUT VOLTAGE
PROGRAMMING GUIDE

OUTPUT VOLTAGE	RESET VOLTAGE	R1	R2	UNIT
1.5 V	-†	45.3	169	k Ω
1.8 V	-†	88.7	169	k Ω
2.5 V	2.37 V	191	169	k Ω
3.3 V	3.13 V	309	169	k Ω
3.6 V	3.42 V	348	169	k Ω
4 V	3.80 V	402	169	k Ω
5 V	4.75 V	549	169	k Ω
6.4 V	6.08 V	750	169	k Ω

† Non-operational below 1.9 V

Figure 34. TPS7301 Adjustable LDO Regulator Programming

APPLICATION INFORMATION

undervoltage supervisor function

The $\overline{\text{RESET}}$ outputs of the TPS73HD3xx initiate a reset in microcomputer and microprocessor systems in the event of an undervoltage condition. An internal comparator in the TPS73HD3xx monitors the output voltage of the regulator to detect the undervoltage condition. When that occurs, the $\overline{\text{RESET}}$ output transistor turns on, taking the $\overline{\text{RESET}}$ signal low.

At programmed output voltages below 1.9 V (on the adjustable regulator only) and on the 1.8 V regulator the reset function becomes unusable. With a minimum output voltage requirement for a valid $\overline{\text{RESET}}$ signal (over temperature) being 1.9 V, $\overline{\text{RESET}}$ will not operate reliably in this range.

On power up, the output voltage tracks the input voltage. The $\overline{\text{RESET}}$ output becomes active (low) as V_I approaches the minimum required for a valid $\overline{\text{RESET}}$ signal (specified at 1.5 V for 25°C and 1.9 V over full recommended operating temperature range). When the output voltage reaches the appropriate positive-going input threshold (V_{IT+}), a 200-ms (typical) timeout period begins during which the $\overline{\text{RESET}}$ output remains low. Once the timeout has expired, the $\overline{\text{RESET}}$ output becomes inactive. Since the $\overline{\text{RESET}}$ output is an open-drain NMOS, a pullup resistor should be used to ensure that a logic-high signal is indicated.

The supply-voltage-supervisor function is also activated during power down. As the input voltage decays and after the dropout voltage is reached, the output voltage tracks linearly with the decaying input voltage. When the output voltage drops below the specified negative-going input threshold (V_{IT-} — see electrical characteristics tables), the $\overline{\text{RESET}}$ output becomes active (low). It is important to note that if the input voltage decays below the minimum required for a valid $\overline{\text{RESET}}$, the $\overline{\text{RESET}}$ is undefined.

Since the circuit is monitoring the regulator output voltage, the $\overline{\text{RESET}}$ output can also be triggered by disabling the regulator or by any fault condition that causes the output to drop below V_{IT-} . Examples of fault conditions include a short circuit on the output and a low input voltage. Once the output voltage is reestablished, either by reenabling the regulator or removing the fault condition, then the internal timer is initiated, which holds the $\overline{\text{RESET}}$ signal active during the 200-ms (typical) timeout period.

Transient loads or line pulses can also cause a reset to occur if proper care is not taken in selecting the input and output capacitors. Load transients that are faster than 5 μs can cause a reset if high-ESR output capacitors (greater than approximately 7 Ω) are used. A 1- μs transient causes a reset when using an output capacitor with greater than 3.5 Ω of ESR. Note that the output-voltage spike during the transient can drop well below the reset threshold and still not trip if the transient duration is short. A 1- μs transient must drop at least 500 mV below the threshold before tripping the reset circuit. A 2- μs transient trips $\overline{\text{RESET}}$ at just 400 mV below the threshold. Lower-ESR output capacitors help by reducing the drop in output voltage during a transient and should be used when fast transients are expected.

NOTE:

$$V_{IT+} = V_{IT-} + \text{Hysteresis}$$

output noise

The TPS73HD3xx has very low output noise, with a spectral noise density $< 2 \mu\text{V}/\sqrt{\text{Hz}}$. This is important when noise-susceptible systems, such as audio amplifiers, are powered by the regulator.

TPS73HD301, TPS73HD318, TPS73HD325 DUAL-OUTPUT LOW-DROPOUT VOLTAGE REGULATORS

SLVS167C – SEPTEMBER 1998 – REVISED – MAY 1999

APPLICATION INFORMATION

regulator protection

The TPS73HD3xx PMOS-pass transistors have built-in back diodes that safely conduct reverse currents when the input voltage drops below the output voltage (e.g., during power down). Current is conducted from the output to the input and is not internally limited. If extended reverse voltage is anticipated, external limiting might be appropriate.

The TPS73HD3xx also features internal current limiting and thermal protection. During normal operation, the TPS73HD3xx limits output current to approximately 1 A. When current limiting engages, the output voltage scales back linearly until the overcurrent condition ends. While current limiting is designed to prevent gross device failure, care should be taken not to exceed the power dissipation ratings of the package. If the temperature of the device exceeds 165°C, thermal-protection circuitry shuts it down. Once the device has cooled, regulator operation resumes.

PACKAGING INFORMATION

Orderable Device	Status ⁽¹⁾	Package Type	Package Drawing	Pins	Package Qty	Eco Plan ⁽²⁾	Lead/Ball Finish	MSL Peak Temp ⁽³⁾
TPS73HD301PWP	ACTIVE	HTSSOP	PWP	28	50	Green (RoHS & no Sb/Br)	CU NIPDAU	Level-2-260C-1 YEAR
TPS73HD301PWPG4	ACTIVE	HTSSOP	PWP	28	50	Green (RoHS & no Sb/Br)	CU NIPDAU	Level-2-260C-1 YEAR
TPS73HD301PWPR	ACTIVE	HTSSOP	PWP	28	2000	Green (RoHS & no Sb/Br)	CU NIPDAU	Level-2-260C-1 YEAR
TPS73HD301PWPRG4	ACTIVE	HTSSOP	PWP	28	2000	Green (RoHS & no Sb/Br)	CU NIPDAU	Level-2-260C-1 YEAR
TPS73HD318PWP	ACTIVE	HTSSOP	PWP	28	50	Green (RoHS & no Sb/Br)	CU NIPDAU	Level-2-260C-1 YEAR
TPS73HD318PWPG4	ACTIVE	HTSSOP	PWP	28	50	Green (RoHS & no Sb/Br)	CU NIPDAU	Level-2-260C-1 YEAR
TPS73HD318PWPR	ACTIVE	HTSSOP	PWP	28	2000	Green (RoHS & no Sb/Br)	CU NIPDAU	Level-2-260C-1 YEAR
TPS73HD318PWPRG4	ACTIVE	HTSSOP	PWP	28	2000	Green (RoHS & no Sb/Br)	CU NIPDAU	Level-2-260C-1 YEAR
TPS73HD325PWP	ACTIVE	HTSSOP	PWP	28	50	Green (RoHS & no Sb/Br)	CU NIPDAU	Level-2-260C-1 YEAR
TPS73HD325PWPG4	ACTIVE	HTSSOP	PWP	28	50	Green (RoHS & no Sb/Br)	CU NIPDAU	Level-2-260C-1 YEAR
TPS73HD325PWPR	ACTIVE	HTSSOP	PWP	28	2000	Green (RoHS & no Sb/Br)	CU NIPDAU	Level-2-260C-1 YEAR
TPS73HD325PWPRG4	ACTIVE	HTSSOP	PWP	28	2000	Green (RoHS & no Sb/Br)	CU NIPDAU	Level-2-260C-1 YEAR

⁽¹⁾ The marketing status values are defined as follows:

ACTIVE: Product device recommended for new designs.

LIFEBUY: TI has announced that the device will be discontinued, and a lifetime-buy period is in effect.

NRND: Not recommended for new designs. Device is in production to support existing customers, but TI does not recommend using this part in a new design.

PREVIEW: Device has been announced but is not in production. Samples may or may not be available.

OBSOLETE: TI has discontinued the production of the device.

⁽²⁾ Eco Plan - The planned eco-friendly classification: Pb-Free (RoHS), Pb-Free (RoHS Exempt), or Green (RoHS & no Sb/Br) - please check <http://www.ti.com/productcontent> for the latest availability information and additional product content details.

TBD: The Pb-Free/Green conversion plan has not been defined.

Pb-Free (RoHS): TI's terms "Lead-Free" or "Pb-Free" mean semiconductor products that are compatible with the current RoHS requirements for all 6 substances, including the requirement that lead not exceed 0.1% by weight in homogeneous materials. Where designed to be soldered at high temperatures, TI Pb-Free products are suitable for use in specified lead-free processes.

Pb-Free (RoHS Exempt): This component has a RoHS exemption for either 1) lead-based flip-chip solder bumps used between the die and package, or 2) lead-based die adhesive used between the die and leadframe. The component is otherwise considered Pb-Free (RoHS compatible) as defined above.

Green (RoHS & no Sb/Br): TI defines "Green" to mean Pb-Free (RoHS compatible), and free of Bromine (Br) and Antimony (Sb) based flame retardants (Br or Sb do not exceed 0.1% by weight in homogeneous material)

⁽³⁾ MSL, Peak Temp. -- The Moisture Sensitivity Level rating according to the JEDEC industry standard classifications, and peak solder temperature.

Important Information and Disclaimer: The information provided on this page represents TI's knowledge and belief as of the date that it is provided. TI bases its knowledge and belief on information provided by third parties, and makes no representation or warranty as to the accuracy of such information. Efforts are underway to better integrate information from third parties. TI has taken and continues to take reasonable steps to provide representative and accurate information but may not have conducted destructive testing or chemical analysis on incoming materials and chemicals. TI and TI suppliers consider certain information to be proprietary, and thus CAS numbers and other limited information may not be available for release.

In no event shall TI's liability arising out of such information exceed the total purchase price of the TI part(s) at issue in this document sold by TI to Customer on an annual basis.

TAPE AND REEL INFORMATION

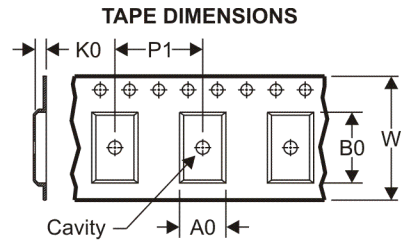
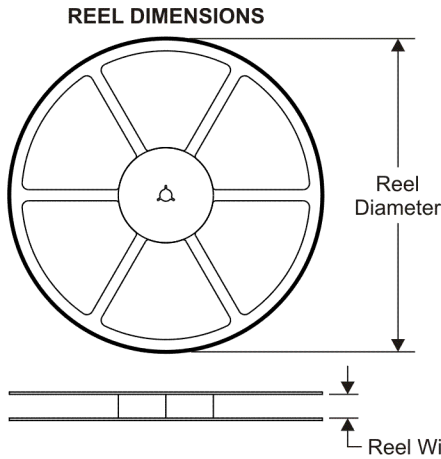

A0	Dimension designed to accommodate the component width
B0	Dimension designed to accommodate the component length
K0	Dimension designed to accommodate the component thickness
W	Overall width of the carrier tape
P1	Pitch between successive cavity centers

QUADRANT ASSIGNMENTS FOR PIN 1 ORIENTATION IN TAPE

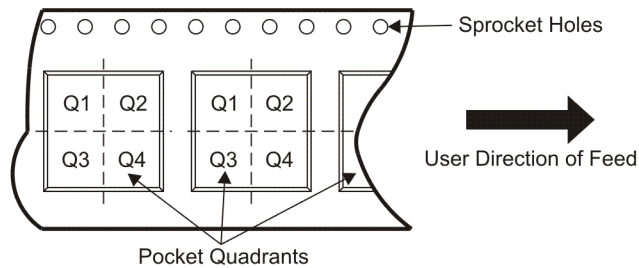

*All dimensions are nominal

Device	Package Type	Package Drawing	Pins	SPQ	Reel Diameter (mm)	Reel Width W1 (mm)	A0 (mm)	B0 (mm)	K0 (mm)	P1 (mm)	W (mm)	Pin1 Quadrant
TPS73HD301PWPR	HTSSOP	PWP	28	2000	330.0	16.4	6.9	10.2	1.8	12.0	16.0	Q1
TPS73HD318PWPR	HTSSOP	PWP	28	2000	330.0	16.4	6.9	10.2	1.8	12.0	16.0	Q1
TPS73HD325PWPR	HTSSOP	PWP	28	2000	330.0	16.4	6.9	10.2	1.8	12.0	16.0	Q1

TAPE AND REEL BOX DIMENSIONS



*All dimensions are nominal

Device	Package Type	Package Drawing	Pins	SPQ	Length (mm)	Width (mm)	Height (mm)
TPS73HD301PWPR	HTSSOP	PWP	28	2000	346.0	346.0	33.0
TPS73HD318PWPR	HTSSOP	PWP	28	2000	346.0	346.0	33.0
TPS73HD325PWPR	HTSSOP	PWP	28	2000	346.0	346.0	33.0

MECHANICAL DATA

PWP (R-PDSO-G**) 20 PIN SHOWN

PowerPAD™ PLASTIC SMALL-OUTLINE PACKAGE

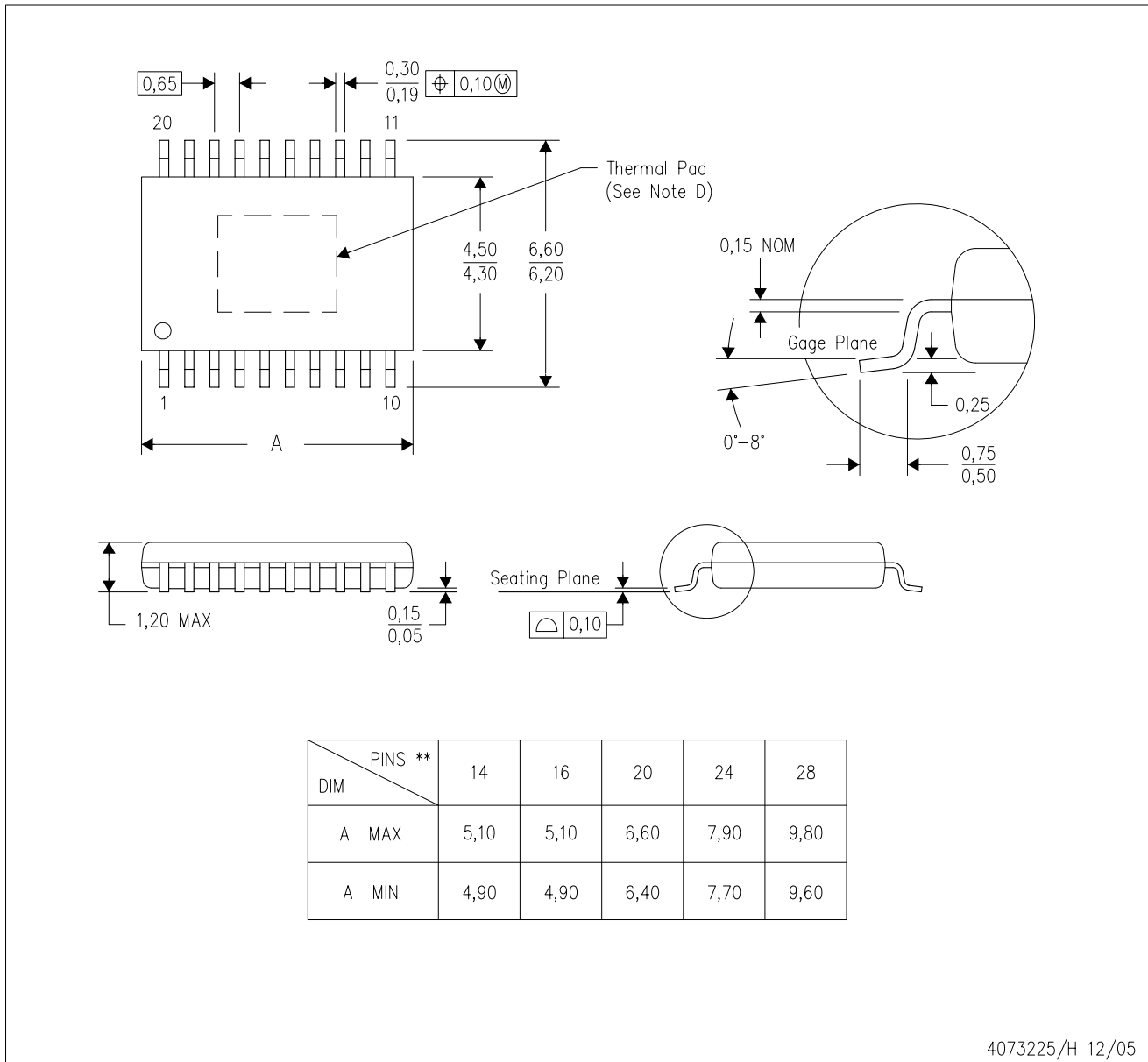

4073225/H 12/05

- NOTES:
- All linear dimensions are in millimeters.
 - This drawing is subject to change without notice.
 - Body dimensions do not include mold flash or protrusions. Mold flash and protrusion shall not exceed 0.15 per side.
 - This package is designed to be soldered to a thermal pad on the board. Refer to Technical Brief, PowerPad Thermally Enhanced Package, Texas Instruments Literature No. SLMA002 for information regarding recommended board layout. This document is available at www.ti.com <<http://www.ti.com>>.
 - Falls within JEDEC MO-153

PowerPAD is a trademark of Texas Instruments.



www.BDTIC.com/TI

PWP (R-PDSO-G28)

PowerPAD™ PLASTIC SMALL OUTLINE

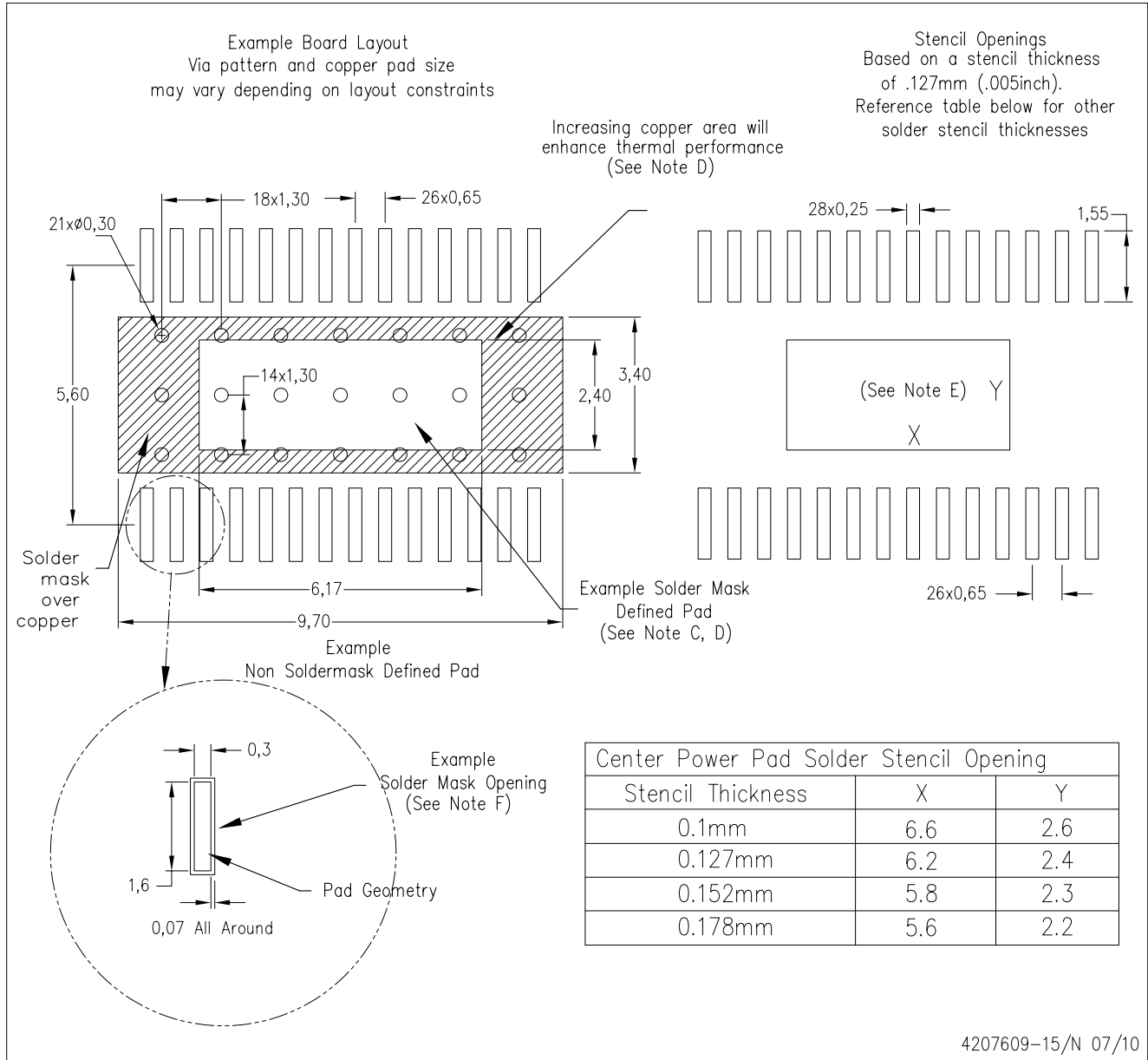

- NOTES:
- All linear dimensions are in millimeters.
 - This drawing is subject to change without notice.
 - Customers should place a note on the circuit board fabrication drawing not to alter the center solder mask defined pad.
 - This package is designed to be soldered to a thermal pad on the board. Refer to Technical Brief, PowerPad Thermally Enhanced Package, Texas Instruments Literature No. SLMA002, SLMA004, and also the Product Data Sheets.
 - For specific thermal information, via requirements, and recommended board layout. These documents are available at www.ti.com <<http://www.ti.com>>. Publication IPC-7351 is recommended for alternate designs. Laser cutting apertures with trapezoidal walls and also rounding corners will offer better paste release. Customers should contact their board assembly site for stencil design recommendations. Example stencil design based on a 50% volumetric metal load solder paste. Refer to IPC-7525 for other stencil
 - Customers should contact their board fabrication site for solder mask tolerances between and around signal pads.

PowerPAD is a trademark of Texas Instruments.



THERMAL PAD MECHANICAL DATA

PWP (R-PDSO-G28)

PowerPAD™ SMALL PLASTIC OUTLINE

THERMAL INFORMATION

This PowerPAD™ package incorporates an exposed thermal pad that is designed to be attached to a printed circuit board (PCB). The thermal pad must be soldered directly to the PCB. After soldering, the PCB can be used as a heatsink. In addition, through the use of thermal vias, the thermal pad can be attached directly to the appropriate copper plane shown in the electrical schematic for the device, or alternatively, can be attached to a special heatsink structure designed into the PCB. This design optimizes the heat transfer from the integrated circuit (IC).

For additional information on the PowerPAD package and how to take advantage of its heat dissipating abilities, refer to Technical Brief, PowerPAD Thermally Enhanced Package, Texas Instruments Literature No. SLMA002 and Application Brief, PowerPAD Made Easy, Texas Instruments Literature No. SLMA004. Both documents are available at www.ti.com.

The exposed thermal pad dimensions for this package are shown in the following illustration.

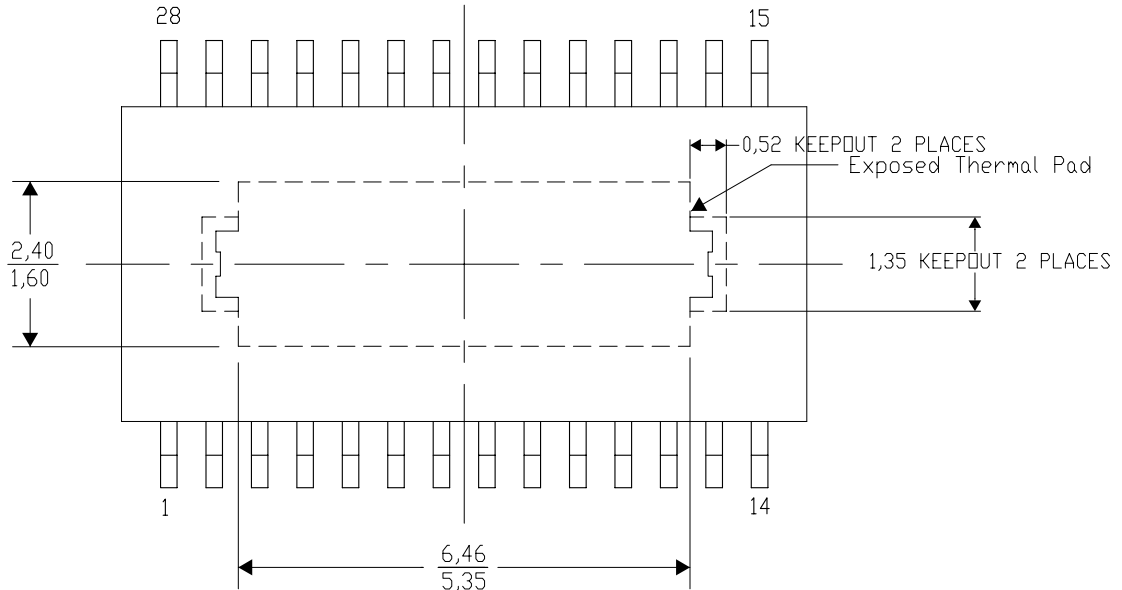

Top View

NOTE: All linear dimensions are in millimeters

Exposed Thermal Pad Dimensions

4206332-21/Q 07/10

PWP (R-PDSO-G28)

PowerPAD™ PLASTIC SMALL OUTLINE

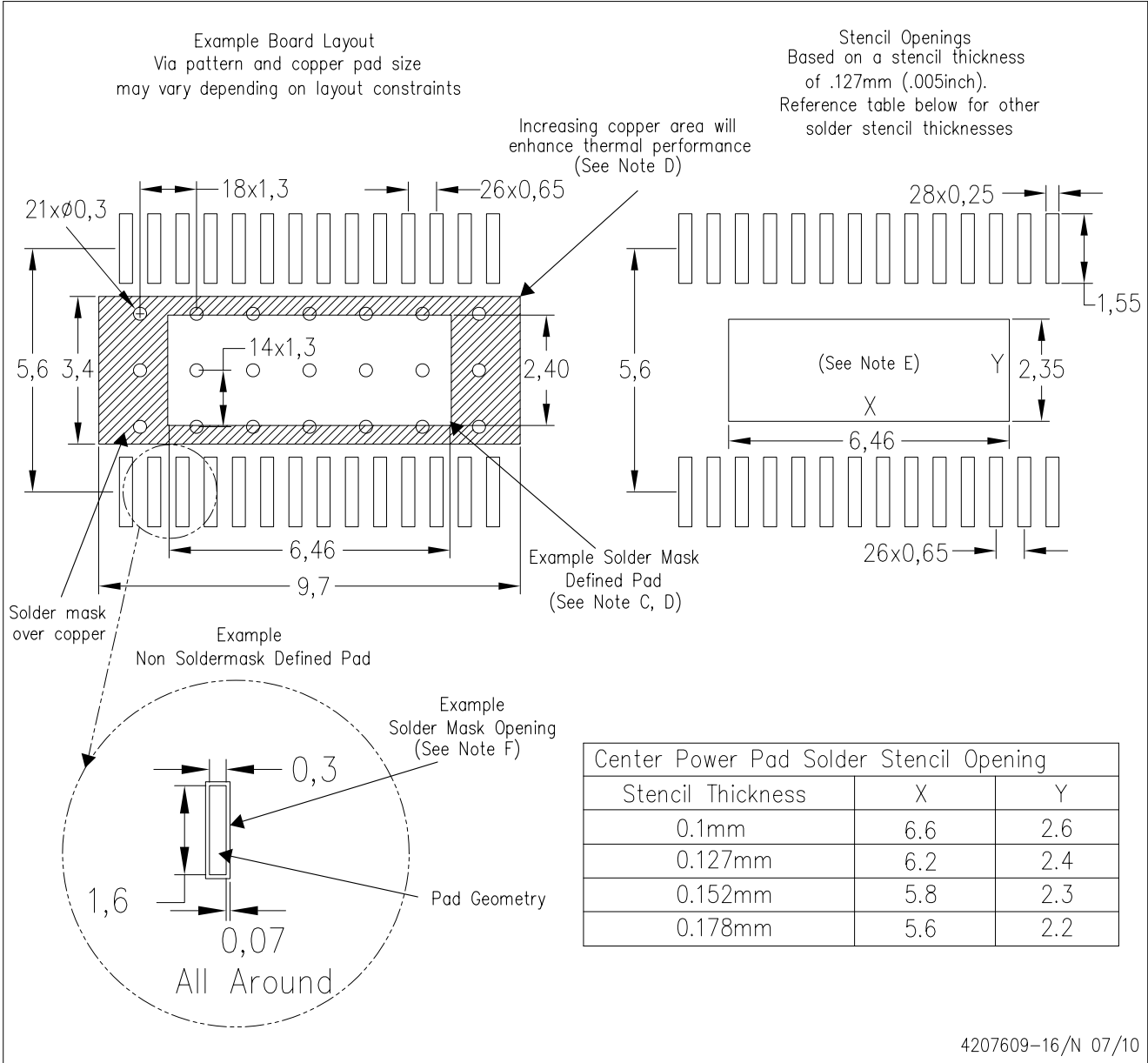

4207609-16/N 07/10

- NOTES:
- A. All linear dimensions are in millimeters.
 - B. This drawing is subject to change without notice.
 - C. Customers should place a note on the circuit board fabrication drawing not to alter the center solder mask defined pad.
 - D. This package is designed to be soldered to a thermal pad on the board. Refer to Technical Brief, PowerPad Thermally Enhanced Package, Texas Instruments Literature No. SLMA002, SLMA004, and also the Product Data Sheets for specific thermal information, via requirements, and recommended board layout. These documents are available at www.ti.com <<http://www.ti.com>>. Publication IPC-7351 is recommended for alternate designs.
 - E. Laser cutting apertures with trapezoidal walls and also rounding corners will offer better paste release. Customers should contact their board assembly site for stencil design recommendations. Example stencil design based on a 50% volumetric metal load solder paste. Refer to IPC-7525 for other stencil recommendations.
 - F. Customers should contact their board fabrication site for solder mask tolerances between and around signal pads.

PowerPAD is a trademark of Texas Instruments.



IMPORTANT NOTICE

Texas Instruments Incorporated and its subsidiaries (TI) reserve the right to make corrections, modifications, enhancements, improvements, and other changes to its products and services at any time and to discontinue any product or service without notice. Customers should obtain the latest relevant information before placing orders and should verify that such information is current and complete. All products are sold subject to TI's terms and conditions of sale supplied at the time of order acknowledgment.

TI warrants performance of its hardware products to the specifications applicable at the time of sale in accordance with TI's standard warranty. Testing and other quality control techniques are used to the extent TI deems necessary to support this warranty. Except where mandated by government requirements, testing of all parameters of each product is not necessarily performed.

TI assumes no liability for applications assistance or customer product design. Customers are responsible for their products and applications using TI components. To minimize the risks associated with customer products and applications, customers should provide adequate design and operating safeguards.

TI does not warrant or represent that any license, either express or implied, is granted under any TI patent right, copyright, mask work right, or other TI intellectual property right relating to any combination, machine, or process in which TI products or services are used. Information published by TI regarding third-party products or services does not constitute a license from TI to use such products or services or a warranty or endorsement thereof. Use of such information may require a license from a third party under the patents or other intellectual property of the third party, or a license from TI under the patents or other intellectual property of TI.

Reproduction of TI information in TI data books or data sheets is permissible only if reproduction is without alteration and is accompanied by all associated warranties, conditions, limitations, and notices. Reproduction of this information with alteration is an unfair and deceptive business practice. TI is not responsible or liable for such altered documentation. Information of third parties may be subject to additional restrictions.

Resale of TI products or services with statements different from or beyond the parameters stated by TI for that product or service voids all express and any implied warranties for the associated TI product or service and is an unfair and deceptive business practice. TI is not responsible or liable for any such statements.

TI products are not authorized for use in safety-critical applications (such as life support) where a failure of the TI product would reasonably be expected to cause severe personal injury or death, unless officers of the parties have executed an agreement specifically governing such use. Buyers represent that they have all necessary expertise in the safety and regulatory ramifications of their applications, and acknowledge and agree that they are solely responsible for all legal, regulatory and safety-related requirements concerning their products and any use of TI products in such safety-critical applications, notwithstanding any applications-related information or support that may be provided by TI. Further, Buyers must fully indemnify TI and its representatives against any damages arising out of the use of TI products in such safety-critical applications.

TI products are neither designed nor intended for use in military/aerospace applications or environments unless the TI products are specifically designated by TI as military-grade or "enhanced plastic." Only products designated by TI as military-grade meet military specifications. Buyers acknowledge and agree that any such use of TI products which TI has not designated as military-grade is solely at the Buyer's risk, and that they are solely responsible for compliance with all legal and regulatory requirements in connection with such use.

TI products are neither designed nor intended for use in automotive applications or environments unless the specific TI products are designated by TI as compliant with ISO/TS 16949 requirements. Buyers acknowledge and agree that, if they use any non-designated products in automotive applications, TI will not be responsible for any failure to meet such requirements.

Following are URLs where you can obtain information on other Texas Instruments products and application solutions:

Products		Applications	
Amplifiers	amplifier.ti.com	Audio	www.ti.com/audio
Data Converters	dataconverter.ti.com	Automotive	www.ti.com/automotive
DLP® Products	www.dlp.com	Communications and Telecom	www.ti.com/communications
DSP	dsp.ti.com	Computers and Peripherals	www.ti.com/computers
Clocks and Timers	www.ti.com/clocks	Consumer Electronics	www.ti.com/consumer-apps
Interface	interface.ti.com	Energy	www.ti.com/energy
Logic	logic.ti.com	Industrial	www.ti.com/industrial
Power Mgmt	power.ti.com	Medical	www.ti.com/medical
Microcontrollers	microcontroller.ti.com	Security	www.ti.com/security
RFID	www.ti-rfid.com	Space, Avionics & Defense	www.ti.com/space-avionics-defense
RF/IF and ZigBee® Solutions	www.ti.com/lprf	Video and Imaging	www.ti.com/video
		Wireless	www.ti.com/wireless-apps

Mailing Address: Texas Instruments, Post Office Box 655303, Dallas, Texas 75265
Copyright © 2010, Texas Instruments Incorporated

www.BDTIC.com/TI